	TECHNICAL SPECIFICATION		N°: I-ET-0000.00-0000-250-P9U-004
	CLIENT: PETROBRAS		SHEET: 1 of 19
	JOB: GENERAL		CC:
	AREA: SUBMARINE RIGID PIPELINE AND RISER		PROJECT: --
--	TITLE: STEEL FORGING REQUIREMENTS FOR SUBMARINE RIGID PIPELINE AND RISER		EDD/EDR --

INDEX OF REVISIONS

REV.	DESCRIPTION AND/OR REVISED SHEETS
0	ORIGINAL

	REV. 0	REV. A	REV. B	REV. C	REV. D	REV. E	REV. F	REV. G	REV. H
DATE	30/12/22								
PROJECT	EDR								
EXECUTION	CWF8								
CHECK	HXA1								
APPROVAL	CLZ2								

THE INFORMATION CONTAINED IN THIS DOCUMENT IS PETROBRAS' PROPERTY AND MAY NOT BE USED FOR PURPOSES OTHER THAN THOSE SPECIFICALLY INDICATED HEREIN.
THIS FORM IS PART OF PETROBRAS' N-381 REV. L.



TECHNICAL SPECIFICATION

Nº: I-ET-0000.00-0000-250-P9U-004

REV. 0

JOB: GENERAL

SHEET: 2 of 19

TITLE: STEEL FORGING REQUIREMENTS FOR SUBMARINE RIGID PIPELINE AND RISER

EDD/EDR

-

TABLE OF CONTENTS

1 CHANGES IN SECTION 1 OF DNV-RP-0034 - GENERAL 3

2 CHANGES IN SECTION 2 OF DNV-RP-0034 – QA & QC..... 6

2.1 STEEL FORGING CLASSES 6

2.2 PURCHASE ORDER INFORMATION 6

2.3 QUALITY MANAGEMENT SYSTEM..... 6

2.4 MANUFACTURING PROCEDURE SPECIFICATION 6

2.5 CERTIFICATION AND DOCUMENTATION 7

3 CHANGES IN SECTION 3 OF DNV-RP-0034 - TECHNICAL PROVISIONS 7

3.1 FORGING 7

3.2 HEAT TREATMENT 7

3.3 PRODUCT ANALYSIS 7

3.4 MECHANICAL TESTING..... 8

3.5 METALLOGRAPHIC EXAMINATION 8

3.6 NON-DESTRUCTIVE TESTING 9

4 CHANGES IN SECTION 4 OF DNV-RP-0034 – MPQ..... 9

4.1 GENERAL..... 9

4.2 QUALIFICATION TESTING..... 9

APPENDIX A – FORGING QUALIFICATION TEST SAMPLING – DNV-ST-F101 (MR) . 11

APPENDIX B – WELD OVERLAY CLADDING. (AR) 16

APPENDIX C – REQUIREMENTS FOR NDT IN CLADDED FORGINGS (AR) 18

APPENDIX D – REQUIREMENTS FOR ECA IN WELD OVERLAY FORGINGS (AR).... 19

	TECHNICAL SPECIFICATION	Nº: I-ET-0000.00-0000-250-P9U-004	REV. 0
	JOB: GENERAL	SHEET: 3 of 19	
	TITLE: STEEL FORGING REQUIREMENTS FOR SUBMARINE RIGID PIPELINE AND RISER	EDD/EDR	
		-	

1 CHANGES IN SECTION 1 OF DNV-RP-0034 - GENERAL

- 1.1.1 [Item 1.1] This document complements existing industry standards for forging components of pipelines, risers and equipment for subsea applications. The baseline methodology adopted to assess manufacturing, cladding and non-destructive testing shall be according to the procedures and standards defined in [1] and [2] as modified herein. (AR)
- 1.2.1 [Item 1.2] The objective of this document is to provide harmonized technical requirements for the manufacturing of steel forgings, including cladding, non-destructive testing and Engineering Critical Assessment with the aim of improving standardization and obtaining consistent quality. (MR)
- 1.3.1 [Item 1.3] This document sets forth the technical requirements for the qualification, manufacturing and testing of steel forgings intended for components of pipelines and risers in subsea installations. (MR)
- 1.3.2 [Item 1.3] COMPANY acknowledges the use of ASTM A694 F65 or ASTM A707 L3 forging for bodies, attach and anchor collar flanges, and ASTM A707 L5 for the FXJ Riser Extension with internal clad layer where applicable. Additional, Project related metallic material requirements may be also presented in the purchase order. (AR)
- 1.4.1 [Item 1.4] This document is applicable to manufacturers and purchasers of steel forgings for the following subsea applications: (MR)
- a) Flexible joint components as Riser extension, inner End part, body and flange;
 - b) Anchor collar fanges;
 - c) Mother pipes for CS Bends;
 - d) Mother pipes for Clad Bends;
 - e) Spool Straight sections;
 - f) Weld test rings girth weld WPQT and AUT coupons;
 - g) Weld coupons for Cladding WPQT.
- 1.4.2 [Item 1.4] This specification is applicable to CS and CRA cladding. APPENDIX A presents for CS forgings Qualification Test Sampling. For CRA cladding and non-destructive testing, additional requirements are given in APPENDIX B and APPENDIX C, respectively. In APPENDIX D additional requirements for ECA of Weld overlay are presented (AR)
- 1.5.1 This technical specification provides additional requirements (AR) and modified requirements (MR) to ref. [2]. For the sake of clarity, the requirements specified herein shall be read in conjunction with the respective item in ref. [1] and they shall always prevail.
- 1.5.2 In the event of any conflict between this specification or any other applicable code, standard or regulation, this specification shall take precedence. Should CONTRACTOR's procedures deviate from this specification, a written report must be



submitted to COMPANY highlighting the non-conformance, before proceeding with the work. COMPANY's approval of any deviation must be in written form.

1.5.3 [Item 1.5, Table 1-1 and Table 1-2] The referred edition of the following codes, standards, and regulations, shall be used with this specification, unless the use of more recent edition is formal approved. COMPANY documents shall be used in the latest revision. (AR)

- [1] DNV-ST-F101 (2021) Submarine Pipeline Systems
- [2] DNV-RP-0034 (2021) Steel forgings for subsea applications - technical requirements.
- [3] DNV-RP-F108 (2021) Assessment of Flaws in Pipeline and Riser Girth Welds
- [4] DNVGL - 2017-3114 DNVGL Report - JIP Lined and Clad Pipeline Materials, Phase 4 –Guideline for Design and Construction of Lined and Clad Pipelines - Report No.: 2017-3114, Rev. 1.
- [5] I-ET-0000.00-0000-210-P9U-005 Alternative Flaw Acceptance Criteria of Submarine Rigid Pipeline and Riser Welds
- [6] I-ET-0000.00-0000-219-P9U-004 CRA Weld Overlay Clad Pipe Requirements
- [7] ASTM E1823 (2021) Standard Terminology Relating to Fatigue and Fracture Testing
- [8] ASTM E165 (2018) Standard Practice for Liquid Penetrant Testing for General Industry
- [9] ASTM G48 (2020) Standard Test Methods for Pitting and Crevice Corrosion Resistance of Stainless Steels and Related Alloys by Use of Ferric Chloride Solution

1.6.1 [Table 1-3] (MR):

MAY	Verbal form used to indicate a course of action permissible within the limits of this specification requiring the formal COMPANY agreement.
SHOULD	Verbal form used to indicate that among several possibilities, one is recommended as particularly suitable, without mentioning or excluding others, or that a certain course of action is preferred but not necessarily

	TECHNICAL SPECIFICATION	Nº: I-ET-0000.00-0000-250-P9U-004	REV. 0
	JOB: GENERAL	SHEET: 5 of 19	
	TITLE: STEEL FORGING REQUIREMENTS FOR SUBMARINE RIGID PIPELINE AND RISER	EDD/EDR	
			-

required. Other possibilities may be submitted to COMPANY approval under technical query form (TQF).

1.6.2 [Table 1-4] (AR):

COMPANY	PETROBRAS.
CONTRACTOR	The party responsible for the engineering design, procurement and/or construction, as applicable, of the respective contract

1.6.3 [Table 1-5] (AR):

3D FEA	Finite Element Analysis with solid elements
AR	Additional Requirement
AUT	Automated Ultrasonic Testing
DR	Deleted Requirement
ECA	Engineering Critical Assessment
FXJ	Flexible Joint
MPI	Magnetic Particle Inspection
MR	Modified Requirement
PoD	Probability of Detection
PoR	Probability of Rejection
QA	Quality Assurance
QC	Quality Control
WPQT	Welding Procedure Qualification Testing
WPS	Welding Procedure Specification
WTC	Welding Testing Coupon

	TECHNICAL SPECIFICATION	Nº: I-ET-0000.00-0000-250-P9U-004	REV. 0
	JOB: GENERAL	SHEET: 6 of 19	
	TITLE: STEEL FORGING REQUIREMENTS FOR SUBMARINE RIGID PIPELINE AND RISER	EDD/EDR	
			-

2 CHANGES IN SECTION 2 OF DNV-RP-0034 – QA & QC

2.1 STEEL FORGING CLASSES

- 2.1.1 [Item 2.1] The forging components classified as SFC 3 are FXJ Riser Extension, FXJ flange, reelable and non reelable anchor forgings and associated WTC and AUT coupons. The adoption of SFC 2 for “non-fatigue sensitive” components in the FXJ other than Riser extension and flange is possible according to clause 2.1.2 of this specification. (AR)
- 2.1.2 [Item 2.1] If not specified in project documents, forged components with girth welds and cladding welds classified as “non-fatigue-sensitive” may be classified as “non-fatigue sensitive” components. For fatigue sensitive welds definition, including CRA cladding ref. shall be considered. (AR)

2.2 PURCHASE ORDER INFORMATION

- 2.2.1 [Item 2.2] Project documents shall inform if the presence of H₂S, CO₂ or other aggressive environment promotes corrosion fatigue or any mechanical properties degradation which requires an internal surface protection by means a deposition of a minimum layer of UNS 06625 (Alloy 625) weld overlay. (AR)
- 2.2.2 [Item 2.2] Whether drawings, WPS and NDT procedures shall be submitted indicating weld overlay location, machining, welding parameters, and acceptance criteria. (AR)
- 2.2.3 [Item 2.2] Whether a Project Quality Plan shall be submitted for Contractor and Company review. (AR)

2.3 QUALITY MANAGEMENT SYSTEM

- 2.3.1 [Item 2.3] The forge masters and steel manufacturers shall have a certified quality management system (QMS) in accordance with ISO 9001. QMS shall operate in an effective manner at each manufacturing plant proposed. This requirement is also valid for the subcontractors. (MR)

2.4 MANUFACTURING PROCEDURE SPECIFICATION

- 2.4.1 [Item 2.4] The final manufacturing procedures (MPS and ITP) shall be approved before starting any forging activity. (AR)
- 2.4.2 [Item 2.4 and Table 2-4] The following process activities / Description shall be included in the MPS: 1) General / Manufacturing flow chart; 2) Starting materials / Cutting of raw material; 4) Heat treatment / Rough machining before Heat treatment / Re-heat treatment, as applicable; 5) Mechanical testing... / Test sampling and Cutting of sacrificial and (or) Prolongation pieces / CTOD testing for SCF 3 / Type of actual microstructures clearly identified in the metallographic report / Re-testing strategy; 9) Pre-machining for cladding / Pre machined drawings; 10) Cladding / WPS

	TECHNICAL SPECIFICATION	Nº: I-ET-0000.00-0000-250-P9U-004	REV. 0
	JOB: GENERAL	SHEET: 7 of 19	
	TITLE: STEEL FORGING REQUIREMENTS FOR SUBMARINE RIGID PIPELINE AND RISER	EDD/EDR	
			-

and Welding book (PQR); 11) NDT after cladding, as applicable / Visual examination / Dye Penetrant Inspection (DPI) / UT Examination / Radiographic Examination / Positive Material Identification (PMI). 12) Final machining / final machining drawings and 13) NDT after final machining, as applicable / Dye Penetrant Inspection (DPI) / UT Examination / Magnetic Particle inspection (MPI). (AR)

2.5 CERTIFICATION AND DOCUMENTATION

2.5.1 [Item 2.7] The certificates shall be accompanied by documentation and records as follows: Thermocouples and furnaces certificates, Cladding data records, NDT personnel and cladding weld operators' certificates. (AR)

3 CHANGES IN SECTION 3 OF DNV-RP-0034 - TECHNICAL PROVISIONS

3.1 FORGING

3.1.1 [Item 3.1.3.2] For each ingot, the discard ratio for both head and tail shall be specified into the MPS for information. (AR)

3.1.2 [Item 3.1.3.4] Weld test ring forging ratio shall be between 4:1 and the forging ratio of the associated production pieces weld end. (AR)

3.2 HEAT TREATMENT

3.2.1 [Item 3.1.4.2] At any time, the water quenching temperature shall not exceed 40°C and it shall be recorded at quenching end. (AR)

3.2.2 [Item 3.1.4.2] No stacking of SFC 2 and SFC 3 forgings shall be allowed. (MR)

3.2.3 [Item 3.1.4.2] At any time, minimum spacing of parts in the furnace shall be lower than 100 mm. (AR)

3.2.4 [Item 3.1.4.2] For the FXJ Riser Extensions and flanges, at least one contact thermocouple shall be placed at prolongation part and other in the middle of another piece of the same heat treatment lot. (AR)

3.2.5 [Item 3.1.4.2] The maximum transfer time between the heat treatment and the quench tank shall be 60 seconds for ASTM A694 F65. (AR)

3.2.6 [Item 3.1.4.2] The surface metal temperature at removal from the quench tank shall not exceed 150°C. (AR)

3.3 PRODUCT ANALYSIS

3.3.1 [Item 3.2.2] For forgings with $C \leq 0.12\%$, carbon equivalent shall be determined using the Pcm formula as per ref. /A1/. For CS and low alloy steel forgings; an increase in Pcm of more than 0.020 or CE of more than 0.030 requires a new MPQ. (AR)

	TECHNICAL SPECIFICATION	Nº: I-ET-0000.00-0000-250-P9U-004	REV. 0
	JOB: GENERAL	SHEET: 8 of 19	
	TITLE: STEEL FORGING REQUIREMENTS FOR SUBMARINE RIGID PIPELINE AND RISER	EDD/EDR -	

3.3.2 [Item 3.2.2] Preferably, the associated weld test rings, for AUT validation and girth weld WPQT, shall be manufactured with the heat having the highest C Content, the highest CE content or the highest Pcm content. (AR)

3.4 MECHANICAL TESTING

3.4.1 [Item 3.3.1] Test laboratories selected by manufacturer shall have QMS in accordance with ISO/IEC 17025 and ISO 9001. (MR)

3.4.2 [Item 3.3.1] Testing laboratory details shall be presented within the MPS and accreditation certification shall be available for Petrobras and contractor representatives' review. (AR)

3.4.3 [Item 3.3.2] Whether forging component is installed by Reel-lay method, samples for the mechanical, corrosion, hardness testing and metallographic examination shall be submitted to the representative straining and ageing cycles. (AR)

3.4.4 [Item 3.3.3] Testing sampling plan for MPQ and production tests shall be included in the MPS. Testing sampling shall be performed with Petrobras and contractor representatives' involvement. (AR)

3.4.5 [Item 3.3.5.1] Tensile testing shall be performed at both room and elevated temperature. (AR)

3.4.6 [Item 3.3.5.2] The CVN test temperature shall be defined as a function of Tmin (°C) (minimum design temperature - MDT) according to table 7-6 of ref. [1]. For T > 40mm testing temperate shall be Tmin minus 20°C. (MR)

3.4.7 [Item 3.3.5.2] CVN testing shall exhibit a minimum mean value of 50% (minimum individual value of 40%) shear fracture appearance at the specified temperature. (AR)

3.4.8 [Table 3-3] Minimum CVN absorbed energy in longitudinal and transverse directions for SFC 2 and SFC 3 shall be 60 J (avg) and 45 J (single) for forgings with SMYS up to and including 517 MPa. For forgings with SMYS over 517 MPa minimum CVN absorbed energy shall be 70 J (avg) and 55 J (single). Values are based on full-size Charpy V-notch specimens (i.e. 10 mm x 10 mm. (MR)

3.4.9 [Table 3-3] The Longitudinal direction is the one parallel to the primary grain flow direction. The Transverse direction is perpendicular to the Longitudinal. (AR)

3.4.10 [Item 3.3.6.2] Through thickness hardness testing results shall be < 230 HV10 since the forgings are required to be welded or clad. Maximum hardness for outside surface and internal surface shall be 250 HV10. (MR)

3.5 METALLOGRAPHIC EXAMINATION

3.5.1 [Item 3.4] Type of actual microstructures, provided at a magnification of 400X or higher, shall be clearly identified in the metallographic report. (AR)

	TECHNICAL SPECIFICATION	Nº: I-ET-0000.00-0000-250-P9U-004	REV. 0
	JOB: GENERAL	SHEET: 9 of 19	
	TITLE: STEEL FORGING REQUIREMENTS FOR SUBMARINE RIGID PIPELINE AND RISER	EDD/EDR	
			-

3.6 NON-DESTRUCTIVE TESTING

- 3.6.1 [Item 3.5.2] MPI shall be performed according to ASTM A709, on all forgings after machining to final dimensions according to detailed drawings. Acceptance criteria shall be in accordance with table D-8 of DNV-ST-F101ref. [1] and relevant linear indications with length more than 1.5 mm are not permitted. (MR)
- 3.6.2 [Item 3.5.2] MPI surface coverage shall be 100 percent of finish-machined surfaces with magnetization in at least two mutually perpendicular directions (circumferential and longitudinal for hollow cylinders or tubulars). Wet AC yoke method shall be adopted for all MPIs. MPI procedures and magnetization plans shall be approved by PETROBRAS. (AR)
- 3.6.3 [Item 3.5.2] Residual magnetism after MPI shall not exceed 800 A/m. Otherwise, the part shall be demagnetized. (AR)
- 3.6.4 [Item 3.5.4] Each forging shall be ultrasonically examined in accordance with ASTM A388M and the supplementary requirements of D.4 of DNV-ST-F101 ref. [1]. (AR)

4 CHANGES IN SECTION 4 OF DNV-RP-0034 – MPQ

4.1 GENERAL

- 4.1.1 [Item 4.1] Mechanical and corrosion testing on prolongations shall comply with requirements defined in APPENDIX A. Exceptions to requirements stated may be provided on Material Requirements specification issued for each project. All testing shall be performed in the final heat-treated conditions. (AR)

4.2 QUALIFICATION TESTING

- 4.2.1 [Item 4.2.3.2] Test specimen positions of tensile and CVN specimens for qualification testing of each FXJ component shall be as given in tables A-1 to A-6. (MR)
- 4.2.2 [Item 4.2.3.2] Test specimen positions of tensile and CVN specimens for qualification testing of forged anchor collar shall be as given in table A-7. (AR)
- 4.2.3 [Item 4.2.3.2] Test specimen positions of tensile and CVN specimens for qualification testing of forged mother pipes and spool straight pieces shall be as given in table A-8. (AR)
- 4.2.4 [Item 4.2.4.2] For through thickness hardness testing each set shall be tested with, at least five (5) indentations made along one line on the positions given in tables A-1 to A-6 for each FXJ Forged component. (MR)
- 4.2.5 [Item 4.2.6.1] For thickest section of each component sampling position shall be as $\frac{1}{4} T$, $\frac{1}{2} T$ and one specimen at 2mm from ID. (AR)

	TECHNICAL SPECIFICATION	Nº: I-ET-0000.00-0000-250-P9U-004	REV. 0
	JOB: GENERAL	SHEET: 10 of 19	
	TITLE: STEEL FORGING REQUIREMENTS FOR SUBMARINE RIGID PIPELINE AND RISER	EDD/EDR	
		-	

4.2.6 [Item 4.2.7.2] The fracture toughness test shall be performed of each forging heat treatment lot. The crack plane orientation shall be L-C according to ASTM E1823 ref. [7]. Three single-edge bend specimens of width 25 mm or 1 in shall be sampled from $\frac{1}{4}$ T at the critical section of the sacrificial part and tested Specimens shall be taken at equal distances around the circumference of the forging (i.e. every 120 degrees). (MR)

4.2.7 [Item 4.2.7.2] In addition to the information required in ASTM E1820, fracture toughness tests reports shall include: (AR)

- a) Test coupon identification.
- b) Load versus CMOD graphs.
- c) Pop-in assessment, if applicable.

4.2.8 [Item 4.2.7.3] The test temperature shall be the minimum design temperature (MDT). The CTOD value shall be greater than or equal to 0.38mm. (MR)

APPENDIX A – FORGING QUALIFICATION TEST SAMPLING – DNV-ST-F101 (MR)

A.1. Flexible Joint Extension

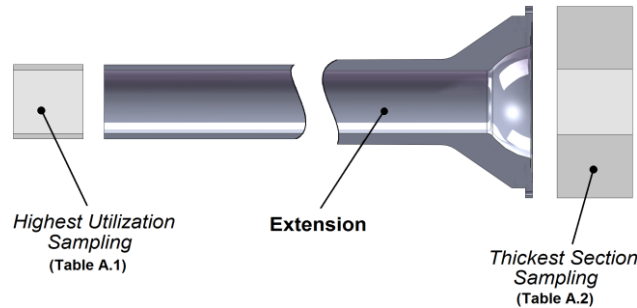

Figure A.1 – Riser Extension and Test Samples Locations

Note: Quality test Samples shall meet DNV-ST-F101 sec.8 requirements. The sampling of solid forgings when the centre will be subsequently removed may be at ID finish instead of the $\frac{1}{2} T$ and $\frac{1}{2} T$ th positions. Same applies to the $\frac{1}{4} T$ and $\frac{3}{4} T$ positions and the $\frac{1}{4} T$ th and $\frac{3}{4} T$ th positions if the centre is subsequently removed.

Table A.1 – Extension Highest Usage Factor Section Testing (also applicable to WTR)

Tensile	2	One specimen in tangential and other in axial direction both at mid thickness (after final machining)
Tensile at Elevate temperature	2	One specimen in tangential and other in axial direction both at mid thickness (after final machining)
Charpy	2 sets	One set in tangential and other in axial direction both at mid thickness (after final machining)
Metallographic	2	As for the CVN impact testing sets
Hardness (Hv10)	6 sets	1.5mm from OD and at mid thickness (120° apart)
CTOD	3	Longitudinal specimens (120° apart)
Steel Cleanliness and Product Analysis	2	As for the CVN impact testing sets

Table A.2 – Extension Thickest Section Testing

Tensile	2	One specimen in tangential direction at $\frac{1}{4}T$ from ID and at least T or 100 mm, whichever is less, from any second surface. One specimen in tangential direction at $\frac{1}{2}T$
Tensile at Elevate temperature	2	One specimen in tangential direction at $\frac{1}{4}T$ from ID and at least T or 100 mm, whichever is less, from any second surface. One specimen in tangential direction at $\frac{1}{2}T$
Charpy	3 sets	One set in tangential direction at $\frac{1}{4}T$ from ID and at least T or 100 mm, whichever is less, from any second surface. One set in tangential direction at $\frac{1}{2}T$ and one set in tangential direction at 2mm from ID.
Metallographic	3	As for the CVN impact testing sets
Hardness	9 sets	1.5mm from OD, 1.5mm from ID and at mid thickness (120° apart)

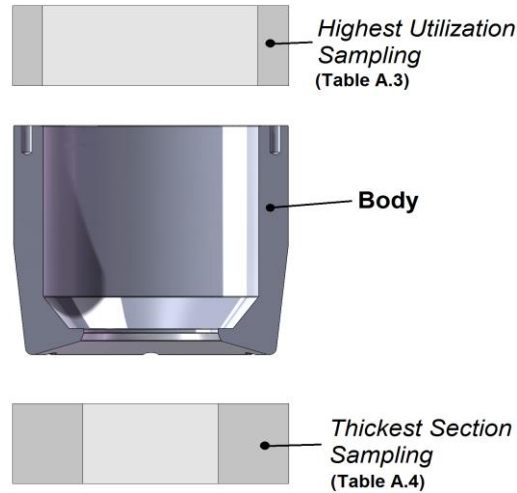
A.2. Flexible Joint Body

Figure A-2 – Flexible Joint Body and Test Samples locations

Note: Quality test Samples shall meet DNV–ST–F101, sec. 8 requirements.

Table A.3 – Body Highest Usage Factor Section Testing

Tensile	2	One specimen in tangential and other in axial direction both at mid thickness (after final machining)
Tensile at Elevate temperature	2	One specimen in tangential and other in axial direction both at mid thickness (after final machining)
Charpy	2 sets	One set in tangential and other in axial direction both at mid thickness (after final machining)
Metallographic	2	As for the CVN impact testing sets
Hardness	6 sets	1.5mm from OD and at mid thickness (120° apart)

Table A.4 – Body Thickest Section Testing

Tensile	2	One specimen in tangential direction at 1/4T from ID and at least T or 100 mm, whichever is less, from any second surface. One specimen in tangential direction at 1/2T
Charpy	3 sets	One set in tangential direction at 1/4T from ID and at least T or 100 mm, whichever is less, from any second surface. One set in tangential direction at 1/2T and one set in tangential direction at 2mm from ID.
Metallographic	3	As for the CVN impact testing sets
Hardness	9 sets	1.5mm from OD, 1.5mm from ID and at mid thickness (120° apart)

A.3. Attached Flange

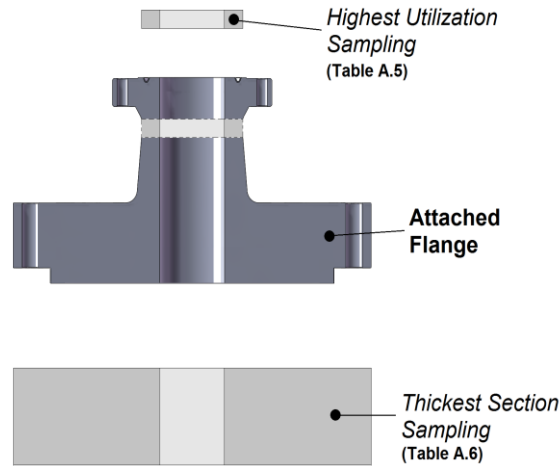

Figure A.3 – Attached Flange and Test Samples locations

Note: Quality test Samples shall meet DNV–ST–F101, sec. 8 requirements.

Table A.5 – Attached Flange Highest Usage Factor Section Testing

Tensile	2	One specimen in tangential and other in axial direction both at mid thickness (after final machining)
Tensile at Elevate temperature	2	One specimen in tangential and other in axial direction both at mid thickness (after final machining)
Charpy	2 sets	One set in tangential and other in axial direction both at mid thickness (after final machining)
Metallographic	2	As for the CVN impact testing sets
Hardness	6 sets	1.5mm from OD and at mid thickness (120° apart)
Steel Cleanliness and Product Analysis	2	As for the CVN impact testing sets (1 per Heat)

Table A.6 – Attached Flange Thickest Section Testing

Tensile	2	One specimen in tangential direction at 1/4T from ID and at least T or 100 mm, whichever is less, from any second surface. One specimen in tangential direction at 1/2T
Tensile at Elevate temperature	2	One specimen in tangential direction at 1/4T from ID and at least T or 100 mm, whichever is less, from any second surface. One specimen in tangential direction at 1/2T
Charpy	3 sets	One set in tangential direction at 1/4T from ID and at least T or 100 mm, whichever is less, from any second surface. One set in tangential direction at 1/2T and one set in tangential direction at 2mm from ID.
Metallographic	3	As for the CVN impact testing sets
Hardness	9 sets	1.5mm from OD, 1.5mm from ID and at mid thickness (120° apart)

A.4. Anchor Collar Flange

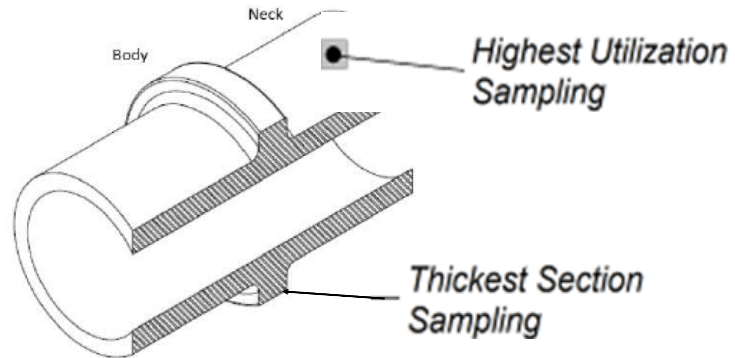

Figure A.4 – Anchor Collar Flange and Test Samples locations

Note: The sampling of solid forgings when the centre will be subsequently removed may be at ID finish instead of the $\frac{1}{2} T$ and $\frac{1}{2} T$ th positions. Same applies to the $\frac{1}{4} T$ and $\frac{3}{4} T$ positions and the $\frac{1}{4} T$ th and $\frac{3}{4} T$ th positions if the centre is subsequently removed

Table A.7 – Anchor Collar Highest Usage Factor Section Testing (also applicable to WTR)

Tensile	2	One specimen in tangential and other in axial direction both at mid thickness (after final machining)
Tensile at Elevate temperature	2	One specimen in tangential and other in axial direction both at mid thickness (after final machining)
Charpy	2 sets	One set in tangential and other in axial direction both at mid thickness (after final machining)
Metallographic	2	As for the CVN impact testing sets
Hardness	6 sets	1.5mm from OD and at mid thickness (120° apart)
CTOD	3	Longitudinal specimens (120° apart)
Steel Cleanliness and Product Analysis	2	As for the CVN impact testing sets (1 per Heat)

Table A.8 – Anchor Collar Flange Thickest Section Testing

Tensile	2	One specimen in tangential direction at $\frac{1}{4}T$ from ID and at least T or 100 mm, whichever is less, from any second surface. One specimen in tangential direction at $\frac{1}{2}T$
Tensile at Elevate temperature	2	One specimen in tangential direction at $\frac{1}{4}T$ from ID and at least T or 100 mm, whichever is less, from any second surface. One specimen in tangential direction at $\frac{1}{2}T$
Charpy	3 sets	One set in tangential direction at $\frac{1}{4}T$ from ID and at least T or 100 mm, whichever is less, from any second surface. One set in tangential direction at $\frac{1}{2}T$ and one set in tangential direction at 2mm from ID.
Metallographic	3	As for the CVN impact testing sets
Hardness	9 sets	1.5mm from OD, 1.5mm from ID and at mid thickness (120° apart)

A.5. Mother pipe for Bends and Straight section for Spools



Figure A.5 – Prolongation and Test Samples Locations

Note: Quality test Samples shall meet DNV–ST–F101 sec.8 requirements. The sampling of solid forgings when the centre will be subsequently removed may be at ID finish instead of the $\frac{1}{2} T$ and $\frac{1}{2} T_{th}$ positions. Same applies to the $\frac{1}{4} T$ and $\frac{3}{4} T$ positions and the $\frac{1}{4} T_{th}$ and $\frac{3}{4} T_{th}$ positions if the centre is subsequently removed.

Table A.7 – Mother pipe and Spool Straight Section Testing (also applicable to WTR)

Tensile	2	One specimen in tangential and other in axial direction both at mid thickness (after final machining)
Tensile at Elevate temperature	2	One specimen in tangential and other in axial direction both at mid thickness (after final machining)
Charpy	4 sets	One set in transversal and other in longitudinal direction both at mid thickness (after final machining) One set in transversal and other in longitudinal direction both at 2mm from ID.
Metallographic	3	On the specimens of through thickness hardness
Hardness	3	3 specimens - 120° apart with 5 lines (5 indentations per line) 1 indentation line between surface and T/4 OD 1 indentation line at T/4 from OD 1 indentation line T/2 from OD 1 indentation line at 3/4T from OD 1 indentation line between 3/4T from OD and ID surface
CTOD	3	Longitudinal specimens at T/2 (120° apart) – applicable to straight section
Steel Cleanliness and Product Analysis	2	As for the CVN impact testing sets (1 per Heat)

APPENDIX B – WELD OVERLAY CLADDING. (AR)

- B.1. Internal bore of forgings shall be fully cladded, as well on all surface wetted by work fluid in forging components, on the sealing surfaces, as well on the standard flange faces or connector sealing face (when specified) as defined in detailed drawings. Surface shall be overlay welded using CRA alloy UNS N06625 according to ref. [6].
- B.2. Internal cladding shall consist of a minimum of two layers. The final weld overlay thickness and coverage shall be as per indicated in the purchase order and applicable drawings. Weld overlay shall be only performed with GTAW mechanized process or GMAW mechanized process.
- B.3. WPS for weld overlay shall be qualified in accordance with C.5.4 and C.6.4 of ref. [1].
- B.3.1. For the internal cladding, it shall be used the same consumable batch for WPQT and production welds. A change in the batch may be performed, however batch test shall be performed.
- B.3.2. During WPQT and each batch testing, the maximum iron content shall be measured at 2mm from FL and it shall not exceed 10%. Pitting corrosion resistance of weld overlay shall be validated by testing according to ASTM G48 ref. [9] Method A. The maximum weight loss shall not exceed 4.0 g/m² when tested at 50°C for 24 hours. After testing, visible pits shall not be found at 20x magnification.
- B.4. For static loaded components an overlay with a minimum of two passes is required and clad thickness shall be 3 mm minimum.
- B.5. For dynamic loaded components as riser extensions in FXJ and reelable anchor collar flanges the minimum overlay thickness shall be defined as per ECA report issued in accordance with ref. [5]. The maximum height of each machined pass shall not be higher than the maximum height of a full circumferential flaw calculated this ECA.
- B.5.1. Internal machining between layers shall be performed if supplier is not able to carry out volumetric NDT in order to detect and to size (height, length and depth) flaws, such as porosities and lack of fusion, or other planar/volumetric flaws on weld overlay layers. After each internal layer machining DPI shall be carried out. DPI acceptance criteria shall be in accordance with item D.8.11.5. of ref. [1].
- B.5.2. As another option to multiple welding passes with interpass machining, a single pass, multiple torch application, with at least two welding layers, may be performed. In this case weld overlay shall be fully inspected by pAUT system qualified according to ref. [6]. Regardless, a final machining of the entire length of the CRA overlaid ID shall be performed.
- B.5.3. A minimum of 06 (six) equally spaced thickness measurements along the circumference, every 0.400m in the length of the forging shall be taken. CRA layer thickness shall be determined by the difference of the pre- and pos-overlaid measurements done in the same points.

B.6. If CONTRACTOR intends to consider the weld overlay layer contributing to the strength at the Extension, additional requirements of ref. [4] and Appendix A.3 of ref. [6] shall be fulfilled.

B.6.1. For the consideration of the structural contribution of the CRA layer of full weld overlay All-weld tensile testing and Charpy-V-notch testing shall be performed according to Table C-6 of ref. [1]. In order to obtain CVN specimens to test the weld overlay additional weld overlay deposition may be proposed for a more representative notch position as per figure B-1.

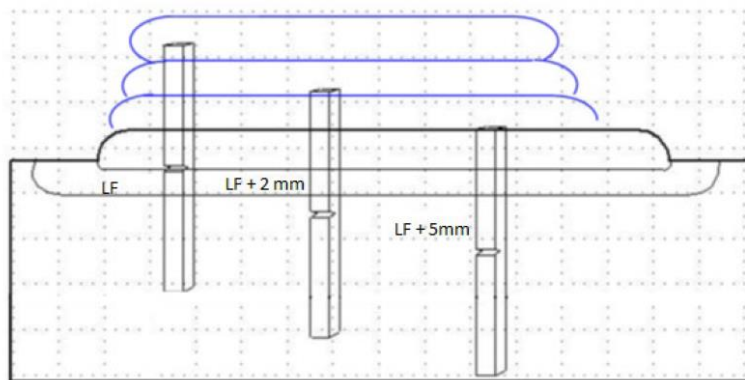

Figure B-1- Orientation of CVN specimens at FL, FL+2 and FL+5mm.

B.7. For fracture toughness testing of weld overlay, two sets of specimens shall be sampled at fusion line. The specimens shall be L-R oriented, according to ASTM E1823 ref. [7], with one set with notch from CS and one set with notch from weld overlay as per the figure B-2 below.

B.7.1. Fracture toughness testing results shall be reported in terms of J. Fracture toughness may be expressed in terms of CTOD when 3D FEA are used to derive CDF. In this case, fracture toughness derived from the double clip gage arrangement according to ASTM E1820 shall be adjusted to consider potential non-conservativeness. Fracture toughness testing procedure shall be submitted for Company approval.

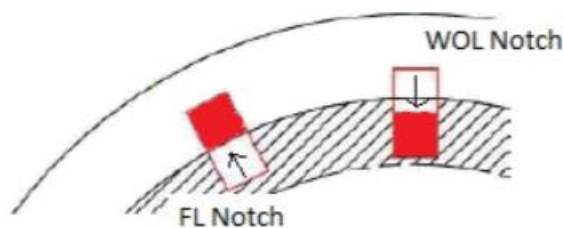

Figure B-2- Orientation of CTOD specimens sets at FL and Weld overlay.

APPENDIX C – REQUIREMENTS FOR NDT IN CLADDED FORGINGS (AR)

C.1. NDT testing shall be in accordance with DNV-ST-F101 ref. [1] and table C-1 of this specification.

Table C-1 – NDT requirements of cladded forged components.

NDT REQUIREMENTS			
TECHNIQUE	DEFECT TYPE	LOCATION	ACCEPTANCE CRITERIA
Visual Inspection DNV-ST-F101	Surface indications	External surface	DNV-ST-F101 item D.4.5.4
		Internal surface	DNV-ST-F101 item D.4.5.4
		Internal Cladding	DNV-ST-F101 item D.3.6.9
Ultrasonic Testing ASTM A388 ASTM A578 ISO 10893-9	Laminar imperfection	Body	DNV-ST-F101 item D.4.5.1
	Lack of fusion	Internal Cladding	DNV-ST-F101 item D.3.6.10
Magnetic Particle Inspection ASTM A275 ISO 9934-1	Surface defects Linear defects Cracks	Body	DNV-ST-F101 table D-8
Dye Penetrant Inspection ASTM E165 ISO 3452-1	Surface defects Linear defects Cracks	Weld preparations and bevels	DNV-ST-F101 item D.3.6.6
		Clad surfaces	DNV-ST-F101 item D.3.6.9
Eddy current Testing ASTM E309	Laminar imperfection	Internal Cladding	DNV-ST-F101 item D.3.6.9

C.2. NDT qualification and validation for Weld overlay of anchor collar components installed by reel Lay method shall be performed as described as follow:

C.2.1. Volumetric NDT qualification and validation according to the same requirements of Full Weld overlay pipe, as per ref. [6]. CONTRACTOR or SUPPLIER shall produce an ECA report, for the detailed design phase to establish the acceptance criteria for WT anchor collar CRA layer (dynamic), in adherence with the provisions of ref. [5].

C.2.2. The exposure of the base metal (steel) to the conveyed fluid due to a full crack through the clad layer shall be considered as a failure. SUPPLIER shall consider an initial flaw size equivalent to an undetected defect throughout the circumference with a height equal to the PoD 90%/95% of the AUT system used in the volumetric inspection of the weld–overlay.

C.2.3. DPI acceptance criteria of clad surfaces shall be in accordance with item D.8.11.5. of ref. [1].

	TECHNICAL SPECIFICATION	Nº: I-ET-0000.00-0000-250-P9U-004	REV. 0
	JOB: GENERAL	SHEET: 19 of 19	
	TITLE: STEEL FORGING REQUIREMENTS FOR SUBMARINE RIGID PIPELINE AND RISER	EDD/EDR	
			-

APPENDIX D – REQUIREMENTS FOR ECA IN WELD OVERLAY FORGINGS (AR)

- D.1. In case of anchor collar components will be reeled, strained and aged condition shall also be assessed regarding fracture properties for ECA analysis. Fracture toughness testing for the WOL shall be performed
- D.2. ECA of weld overlay in clad materials shall not differ significantly from the premises outlined for carbon steel, but a more intensive use of Finite Element (FE) Fracture Mechanics Analyses is expected.
- D.3. ECA of weld overlay in clad materials shall also comply with requirements of ref. [3] and the latest revision of ref. [5]. Whenever there is a recommended approach in the guideline, it shall be considered mandatory unless a better approach is technically justified. Additional and modified requirement are given below:
- D.3.1. The rupture of CRA layer and exposure of CS material to the environment shall be considered as a failure.
- D.3.2. Whenever ECA is mandatory for weld overlay sections and the maximum pass height are higher than the critical full circumferential flaw, NDT requirement shall consist in 100% volumetric inspection to detect lack of fusion and other planar flaws. The NDT detection performance shall be documented to be adequate to reliably reject the smallest critical flaw sizes in the applicable acceptance criteria. For the CRA layer, the 85%/95% PoR shall be the applied method for detection performance evaluation.