	TECHNICAL SPECIFICATION	Nº: I-ET-0000.00-0000-290-P9U-005
	CLIENT: E&P	SHEET: 1 of 43
	JOB: GENERAL	CC ---
	ÁREA: GENERAL	PROJECT: ---
DP&T	TÍTULO: TITANIUM PULL IN TUBE SPECIFICATION	 SUB/ES/EDD/EDR

MS Word®/2003/I-ET-0000.00-0000-290-P9U-005=0.doc

INDEX OF REVISIONS

REV.	DESCRIPTION AND/OR REVISED SHEETS
0	ORIGINAL (Preliminary Version)

	REV. 0	REV. A	REV. B	REV. C	REV. D	REV. E	REV. F	REV. G	REV. H
DATE	07/08/2020								
PROJECT	EISE/EDR								
EXECUTION	TS8H								
CHECK	TS8H								
APPROVAL	CLZ2								

THE INFORMATION CONTAINED IN THIS DOCUMENT IS PETROBRAS PROPERTY AND MAY NOT BE USED FOR PURPOSES OTHER THAN THOSE SPECIFICALLY INDICATED HEREIN. THIS FORM IS PART OF PETROBRAS N-381 REV. L







	TECHNICAL SPECIFICATION	Nº I-ET-0000.00-0000-290-P9U-005	REV. 0
	JOB: GENERAL		SHEET 2 of 43
	TITLE: TITANIUM PULL IN TUBE SPECIFICATION		 SUB/ES/EDD/EDR

TABLE OF CONTENTS

1. INTRODUCTION	4
1.1. SCOPE OF THIS DOCUMENT	4
1.2. PROJECT DOCUMENTATION AND RESPONSABILITIES.....	5
1.3. SYSTEM DESCRIPTION	5
2. DEFINITIONS AND ABBREVIATIONS	8
2.1. DEFINITIONS.....	8
2.2. ABBREVIATIONS.....	9
3. REFERENCES	11
3.1. PROJECT DOCUMENTS.....	11
3.2. PETROBRAS'S REFERENCES	11
3.3. DET NORSKE VERITAS (DNV).....	12
3.4. AMERICAN PETROLEUM INSTITUTE (API)	12
3.5. NATIONAL ASSOCIATION OF CORROSION ENGINEERS (NACE).....	12
3.6. AMERICAN SOCIETY OF TESTING AND MATERIALS (ASTM)	13
3.7. AMERICAN SOCIETY OF MECHANICAL ENGINEERS (ASME).....	13
3.8. OTHER STANDARDS.....	14
3.9. CONFLICT OF INFORMATION AND DOCUMENT APPROVAL	14
4. GENERAL REQUIREMENTS	15
4.1. MATERIAL SUPPLIED.....	15
4.2. MATERIAL SELECTION	16
4.3. SUPPLIER'S RESPONSIBILITIES	17
4.4. PRODUCT QUALIFICATION	18
4.5. UNIT OF MEASUREMENTS.....	18
5. FUNCTIONAL REQUIREMENT	18
5.1. TIPT ASSEMBLY	18
5.2. ADAPTOR CAP SET.....	19
5.3. STEEL TRANSITION SPOOL.....	19
5.4. COMPACT FLANGES.....	19
5.5. EXTERNAL COATINGS.....	20
5.6. TIPT RISER MONITORING SYSTEM (TRMS).....	20
5.7. INSTALLATION AND PRE-COMISSIONING.....	20
6. MATERIAL REQUIREMENTS	20
7. DESIGN REQUIREMENT	20
7.1. GENERAL.....	20
7.2. INTERFACES.....	21

	TECHNICAL SPECIFICATION	Nº I-ET-0000.00-0000-290-P9U-005	REV. 0																																																																										
	JOB: GENERAL		SHEET 3 of 43																																																																										
	TITLE: TITANIUM PULL IN TUBE SPECIFICATION		 SUB/ES/EDD/EDR																																																																										
<table border="0"> <tr> <td>7.2.1. INTERFACE WITH LOWER RISER BALCONY</td> <td>21</td> </tr> <tr> <td>7.2.2. INTERFACE WITH UPPER RISER BALCONY</td> <td>21</td> </tr> <tr> <td>7.2.3. INTERFACE WITH THE STEEL RISER</td> <td>21</td> </tr> <tr> <td>7.3. DIMENSIONS.....</td> <td>22</td> </tr> <tr> <td>7.3.1. GENERAL.....</td> <td>22</td> </tr> <tr> <td>7.3.1.1. LENGTH ADJUSTMENT ("CUT-TO-LENGTH").....</td> <td>22</td> </tr> <tr> <td>7.3.2. UPPER BALCONY</td> <td>23</td> </tr> <tr> <td>7.3.3. LOWER BALCONY</td> <td>23</td> </tr> <tr> <td>7.4. DESIGN LOADS.....</td> <td>23</td> </tr> <tr> <td>7.5. LOADING CASES</td> <td>23</td> </tr> <tr> <td>7.5.1. Interface Loads.....</td> <td>25</td> </tr> <tr> <td>7.6. DESIGN CRITERIA.....</td> <td>25</td> </tr> <tr> <td>7.7. FATIGUE REQUIREMENTS.....</td> <td>26</td> </tr> <tr> <td>7.8. FATIGUE ANALYSIS</td> <td>26</td> </tr> <tr> <td>7.9. ECA REQUIREMENTS</td> <td>27</td> </tr> <tr> <td>7.10. MAINTENANCE</td> <td>27</td> </tr> <tr> <td>7.11. IN-SERVICE INSPECTION</td> <td>27</td> </tr> <tr> <td>7.12. PIGGING REQUIREMENTS</td> <td>28</td> </tr> <tr> <td>7.12.1. Conventional Pig.....</td> <td>28</td> </tr> <tr> <td>7.12.2. Inspection Pig</td> <td>28</td> </tr> <tr> <td>7.13. INSTALLATION</td> <td>29</td> </tr> <tr> <td>7.14. CONNECTION AND WELDING.....</td> <td>29</td> </tr> <tr> <td>7.15. STEEL PARTS CORROSION PROTECTION</td> <td>30</td> </tr> <tr> <td>8. MANUFACTURING REQUIREMENTS.....</td> <td>30</td> </tr> <tr> <td>9. INSPECTION AND MATERIAL TESTING OF TITANIUM PARTS</td> <td>30</td> </tr> <tr> <td>9.1. STEEL FORGINGS.....</td> <td>30</td> </tr> <tr> <td>9.2. CRA WELD OVERLAY ON STEEL PARTS.....</td> <td>30</td> </tr> <tr> <td>10.INSPECTION AND MATERIAL TESTING OF STEEL PARTS.....</td> <td>30</td> </tr> <tr> <td>11.COMPONENT TESTING REQUIREMENTS.....</td> <td>30</td> </tr> <tr> <td>11.1. FACTORY ACCEPTANCE TEST</td> <td>31</td> </tr> <tr> <td>11.1.1. HYDROSTATIC PRESSURE TEST</td> <td>31</td> </tr> <tr> <td>11.1.2. TEST DOCUMENTATION.....</td> <td>32</td> </tr> <tr> <td>11.2. DIMENSIONAL AND VISUAL INSPECTION</td> <td>32</td> </tr> <tr> <td>11.2.1. DIMENSIONAL INSPECTION.....</td> <td>33</td> </tr> <tr> <td>11.2.2. VISUAL INSPECTION.....</td> <td>33</td> </tr> <tr> <td>11.2.3. FASTENERS</td> <td>33</td> </tr> <tr> <td>12. TECHNOLOGY QUALIFICATION OF TITANIUM PULL IN TUBE.....</td> <td>33</td> </tr> </table>				7.2.1. INTERFACE WITH LOWER RISER BALCONY	21	7.2.2. INTERFACE WITH UPPER RISER BALCONY	21	7.2.3. INTERFACE WITH THE STEEL RISER	21	7.3. DIMENSIONS.....	22	7.3.1. GENERAL.....	22	7.3.1.1. LENGTH ADJUSTMENT ("CUT-TO-LENGTH").....	22	7.3.2. UPPER BALCONY	23	7.3.3. LOWER BALCONY	23	7.4. DESIGN LOADS.....	23	7.5. LOADING CASES	23	7.5.1. Interface Loads.....	25	7.6. DESIGN CRITERIA.....	25	7.7. FATIGUE REQUIREMENTS.....	26	7.8. FATIGUE ANALYSIS	26	7.9. ECA REQUIREMENTS	27	7.10. MAINTENANCE	27	7.11. IN-SERVICE INSPECTION	27	7.12. PIGGING REQUIREMENTS	28	7.12.1. Conventional Pig.....	28	7.12.2. Inspection Pig	28	7.13. INSTALLATION	29	7.14. CONNECTION AND WELDING.....	29	7.15. STEEL PARTS CORROSION PROTECTION	30	8. MANUFACTURING REQUIREMENTS.....	30	9. INSPECTION AND MATERIAL TESTING OF TITANIUM PARTS	30	9.1. STEEL FORGINGS.....	30	9.2. CRA WELD OVERLAY ON STEEL PARTS.....	30	10.INSPECTION AND MATERIAL TESTING OF STEEL PARTS.....	30	11.COMPONENT TESTING REQUIREMENTS.....	30	11.1. FACTORY ACCEPTANCE TEST	31	11.1.1. HYDROSTATIC PRESSURE TEST	31	11.1.2. TEST DOCUMENTATION.....	32	11.2. DIMENSIONAL AND VISUAL INSPECTION	32	11.2.1. DIMENSIONAL INSPECTION.....	33	11.2.2. VISUAL INSPECTION.....	33	11.2.3. FASTENERS	33	12. TECHNOLOGY QUALIFICATION OF TITANIUM PULL IN TUBE.....	33
7.2.1. INTERFACE WITH LOWER RISER BALCONY	21																																																																												
7.2.2. INTERFACE WITH UPPER RISER BALCONY	21																																																																												
7.2.3. INTERFACE WITH THE STEEL RISER	21																																																																												
7.3. DIMENSIONS.....	22																																																																												
7.3.1. GENERAL.....	22																																																																												
7.3.1.1. LENGTH ADJUSTMENT ("CUT-TO-LENGTH").....	22																																																																												
7.3.2. UPPER BALCONY	23																																																																												
7.3.3. LOWER BALCONY	23																																																																												
7.4. DESIGN LOADS.....	23																																																																												
7.5. LOADING CASES	23																																																																												
7.5.1. Interface Loads.....	25																																																																												
7.6. DESIGN CRITERIA.....	25																																																																												
7.7. FATIGUE REQUIREMENTS.....	26																																																																												
7.8. FATIGUE ANALYSIS	26																																																																												
7.9. ECA REQUIREMENTS	27																																																																												
7.10. MAINTENANCE	27																																																																												
7.11. IN-SERVICE INSPECTION	27																																																																												
7.12. PIGGING REQUIREMENTS	28																																																																												
7.12.1. Conventional Pig.....	28																																																																												
7.12.2. Inspection Pig	28																																																																												
7.13. INSTALLATION	29																																																																												
7.14. CONNECTION AND WELDING.....	29																																																																												
7.15. STEEL PARTS CORROSION PROTECTION	30																																																																												
8. MANUFACTURING REQUIREMENTS.....	30																																																																												
9. INSPECTION AND MATERIAL TESTING OF TITANIUM PARTS	30																																																																												
9.1. STEEL FORGINGS.....	30																																																																												
9.2. CRA WELD OVERLAY ON STEEL PARTS.....	30																																																																												
10.INSPECTION AND MATERIAL TESTING OF STEEL PARTS.....	30																																																																												
11.COMPONENT TESTING REQUIREMENTS.....	30																																																																												
11.1. FACTORY ACCEPTANCE TEST	31																																																																												
11.1.1. HYDROSTATIC PRESSURE TEST	31																																																																												
11.1.2. TEST DOCUMENTATION.....	32																																																																												
11.2. DIMENSIONAL AND VISUAL INSPECTION	32																																																																												
11.2.1. DIMENSIONAL INSPECTION.....	33																																																																												
11.2.2. VISUAL INSPECTION.....	33																																																																												
11.2.3. FASTENERS	33																																																																												
12. TECHNOLOGY QUALIFICATION OF TITANIUM PULL IN TUBE.....	33																																																																												

	TECHNICAL SPECIFICATION	Nº I-ET-0000.00-0000-290-P9U-005	REV. 0
	JOB: GENERAL		SHEET 4 of 43
	TITLE: TITANIUM PULL IN TUBE SPECIFICATION		 SUB/ES/EDD/EDR

12.1. QUALIFICATION SCOPE	34
12.1.1. METALLIC PARTS	34
12.1.2. RUBBER COATING	35
12.1.3. TRMS.....	35
13.QUALITY CONTROL AND REPORTING	36
13.1. QUALITY PLAN AND QUALITY CONTROL PLAN.....	36
13.2. REPORTS AND RECORDS.....	36
13.3. INSPECTION AND MAINTENANCE MANUAL.....	39
13.4. DRAWINGS.....	39
13.5. PROJECT MANAGEMENT	39
13.6. TRACEABILITY AND MARKING	40
13.6.1. RAW MATERIAL	40
13.6.2. PRODUCT MARKING	40
13.6.3. MANUFACTURING OPERATOR AND INSPECTOR MARKING	41
13.7. HANDLING, STORAGE AND SHIPPING	41
13.8. DOCUMENTATION REQUIREMENTS (DATA BOOK)	41
13.9. INSPECTION AND TEST PLAN	42

1. INTRODUCTION



1.1. SCOPE OF THIS DOCUMENT

The purpose of this specification is to define the minimum functional and technical requirements for the design, material selection, manufacture, inspection, testing and delivery of Titanium Pull in Tube to connect rigid risers to the FPU hang-off.

This document shall be read in conjunction with all documents listed in Section 3.

Additional or amended functional requirements for TiPT and requirements for the hang-off, and other interfaces with FPU, can be found within the Project documentation. In general, the TiPT is intended to be connected into Support-Tube type riser supports (I-Tube, BSMF, BSDL or RMoST). The project detailed scope of supply, definitions of the interface with the FPU and definition of the type of top connection should also be defined in project documentation [1] to [6].

This Specification also intend to be used either for newbuilt or retrofit to existing FPU, with the specific requirements for each case clearly stated herein.

	TECHNICAL SPECIFICATION	Nº I-ET-0000.00-0000-290-P9U-005	REV. 0
	JOB: GENERAL	SHEET 5 of 43	
	TITLE: TITANIUM PULL IN TUBE SPECIFICATION	 SUB/ES/EDD/EDR	

1.2. PROJECT DOCUMENTATION AND RESPONSABILITIES

The TiPT design, procurement and installation is set to be within CONTRACTOR's scope of work (full EPCI). The contractual relationships are between CONTRACTOR and SUPPLIER, and between CONTRACTOR and PETROBRAS, and thus the interface between the TiPT, steel riser and FPU supports is entirely within CONTRACTOR scope. The definitive inputs for component design are a CONTRACTOR responsibility. CONTRACTOR is also responsible for issuing its own version of the documents [2] to [6], as well as a TiPT specification, to SUPPLIER, in compliance with the PETROBRAS documentation.

Its highlighted that PETROBRAS will also issue in the BID process the documents of [1] to [6] based on the results of the Basic Design, and information on the FPU interfaces with TiPT. These documents may be used in part or in whole as reference for preliminary sizing during the BID phase, under CONTRACTOR responsibility, as the riser configuration to be defined by the CONTRACTOR may not be the same configuration defined by PETROBRAS in the basic design.



The definition of the final component datasheet, with definitive interface loads, is under CONTRACTOR responsibility. PETROBRAS has no responsibility for changes in design due to differences between PETROBRAS and CONTRACTOR's datasheets.

Scope of supply in this technical specification is amended by Material Requisition/ Data Basis regarding definition whether it includes or not any optional parts, as per Section 4.1.

1.3. SYSTEM DESCRIPTION

A Titanium Pull in Tube Stack-up will include from bottom up: a *Pup Piece* that may be a regular riser pipe or a forged tapered beam (in special cases) with installed sensors (FBG and IMU) for riser monitoring, welded (likely onshore) with a *Steel Compact Flange* with prolonged neck extension, a *Lower Titanium Stress Joint (LTIPT)* properly sized to withstand the imposed riser loads, an *Upper Titanium Stress Joint (UTIPT)* which interfaces with the Support-Tube while absorbing a permanent fixed deflection to align the TiPT with the Upper I-Tube, a *Titanium Spacer Pipe* section formed by several tubular forgings connected by integral Compact Flanges to each other and to a *Steel Transition Spool*, attached to the Upper I-Tube through an "End Fitting" termination, with a standard flange to interface with the FPU top closing pool and with installed sensors (FBG) for riser monitoring.

Figure 2.1 presents a general view of the TiPT Stack-up, with the major elements labelled for reference and some terminologies used in this document.

	TECHNICAL SPECIFICATION	Nº I-ET-0000.00-0000-290-P9U-005	REV. 0
	JOB: GENERAL		SHEET 6 of 43
	TITLE: TITANIUM PULL IN TUBE SPECIFICATION		
			SUB/ES/EDD/EDR

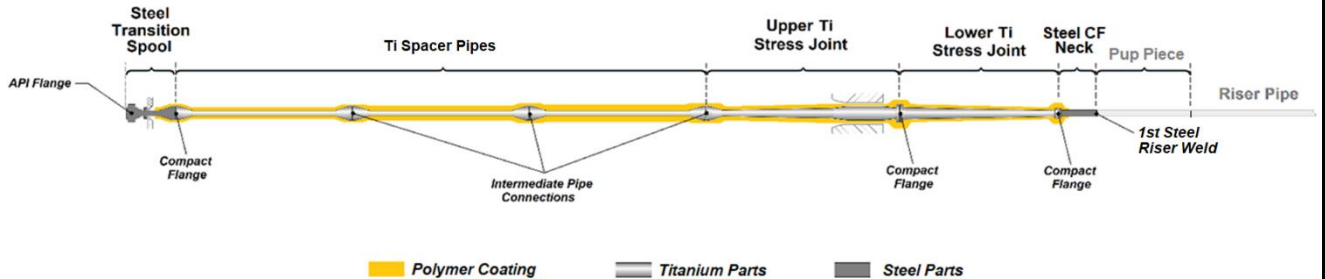

Figure 2.1 – General Schematic View of the TiPT Stack-up and Its Main Sections. spacer

NOTE: Concept of the parts and/ or configuration depicted in Figure 2.1 may vary according to SUPPLIER design.

The function of the Titanium Stress Joint is to:

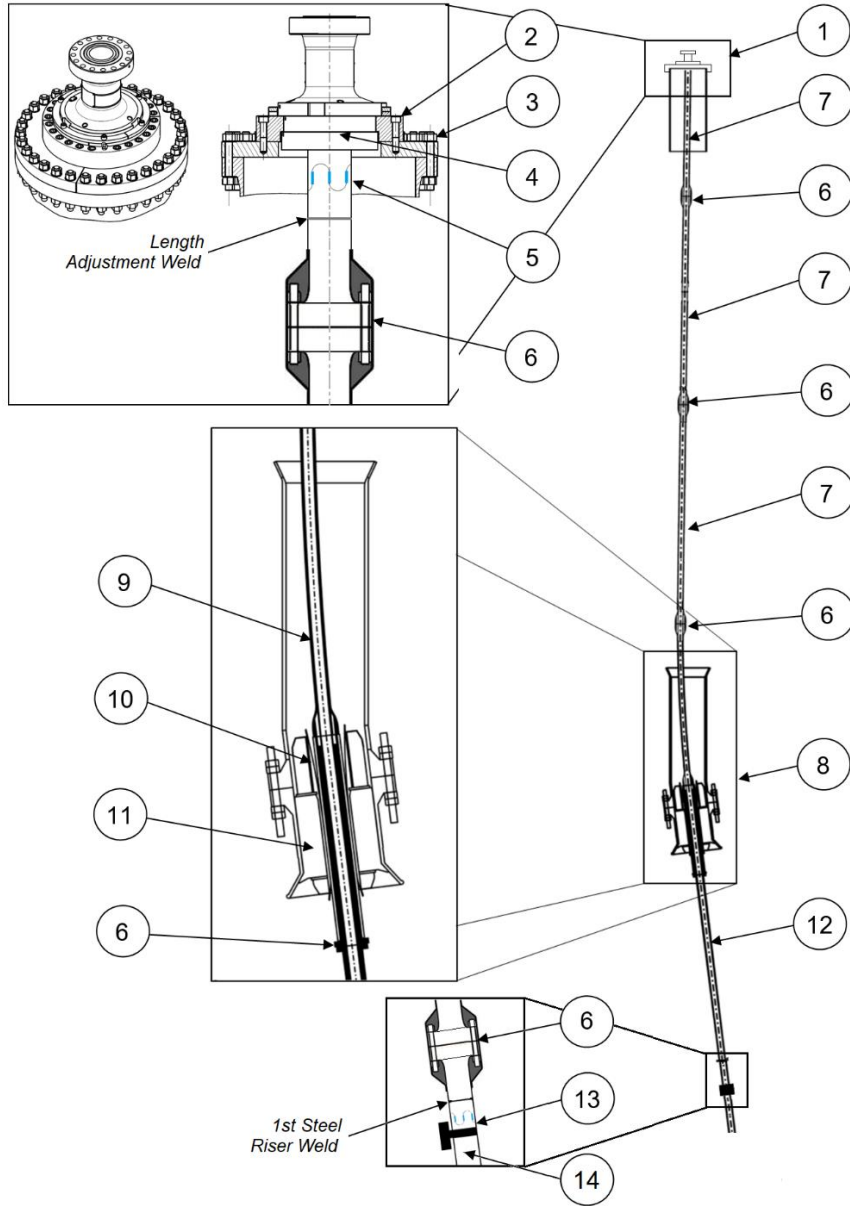

- Support the riser;
- Provide an articulated interface between the FPU and the riser, to allow for relative angular motion between the FPU and the riser, while providing adequate flexibility to limit the transference of loads (mainly bending moments) in the top area of the riser and to the lower balcony structure;
- Provide an interface between the riser and the FPU piping for fluid transportation in the maximum operating condition of pressure and temperature;
- Allows pigs to be transported between FPU piping and the riser;
- Connect the riser to temporary installation equipment (ex: pig launch and receiver or pull in head) during pull in and commissioning activities;

The Main Parts that compose the scope of supply for the TiPT are shown in Figure 2.2.



Part	Description
1	Upper I-Tube (OoS) and Hang-off
2	Bipartite Stopper
3	Bipartite Hang-off Flange
4	"End Fitting" (Steel Transition Spool)
5	Fiber Bragg Grating, with cabling and dry-mate connector (TRMS)
6	Compact Flanges
7	Titanium Spacer Pipes
8	Riser Support-Tube (OoS)
9	Upper Titanium Stress Joint
10	Trumpet
11	Adaptor Cap
12	Lower Titanium Stress Joint
13	Fiber Bragg Grating + IMU, with cabling and wet-mate connector (TRMS)
14	Pup Piece

Figure 2.2 – TiPT General Assembly and Its Main Parts.

	TECHNICAL SPECIFICATION	Nº I-ET-0000.00-0000-290-P9U-005	REV. 0
	JOB:	GENERAL	
	TITLE:	TITANIUM PULL IN TUBE SPECIFICATION	
		SHEET 8 of 43	
		SUB/ES/EDD/EDR	

NOTE: Concept of the parts and/ or configuration depicted in Figure 2.1 may vary according to SUPPLIER design.

2. DEFINITIONS AND ABBREVIATIONS

2.1. DEFINITIONS

PETROBRAS	PETRÓLEO BRASILEIRO S/A. – PETROBRAS Where referred to in this Specification, it means both the Company itself and its employees authorized to communicate with CONTRACTOR or SUPPLIER.
SUPPLIER	The organization that construct the Stress Joint and provides it under a Purchase Order directly to the PETROBRAS or through the CONTRACTOR for riser EPCI Contract
SUB-SUPPLIER	The Party supplying a material or service to the SUPPLIER.
CONTRACTOR	The company responsible for the engineering, procurement, construction and Installation of riser system for the Project.
PARTIES	The companies directly involved in the Titanium Stress Joint specification, design, fabrication and installation, with power to propose modification over design and manufacturing aspects. They are: PETROBRAS, CONTRACTOR and SUPPLIER.
Cutback	Uncoated area defined in terms of length at the end of the Lower CS Compact Flange or Pup Piece which is required to prevent damage to the coating system when the TIPT is welded together with the pipe sections.
EPCI	Contracting mode where the CONTRACTOR is responsible for the detailed engineering, procurement of some or all the riser components, construction, installation and commissioning of riser system.
Monolithic	Refers to a single forged part without welds or other means of permanent connection along the forging.
Pre-commissioning	



Project	Scope of activities performed by the PARTIES to design, construct and install the riser system for a specific field and host FPU.
Requisition	A formal written request for supply of equipment or materials for a specific Project.
Work	All tasks to be performed by the SUPPLIER under the Purchase Order for any specific Project, including all duties and obligations undertaken by the SUPPLIER.
Shall	Indicates a mandatory requirement.
Should	Indicates a preferred course of action.
May	Is used where alternatives are equally acceptable.

2.2. ABBREVIATIONS

The following abbreviations are used in this document:

ALS	Accidental Limit State
AUT	Automatic Ultrasonic Test
CNC	Computer Numerical Control
CoG	Centre of Gravity
CP	Cathodic Protection
CRA	Corrosion Resistant Alloy
CS	Carbon steel
CTOD	Crack Tip Opening Displacement Test
CVN	Charpy V-Notch
DBM	Design Basis and Methodology
ECA	Engineering Critical Assessment
ELI	Extra Low Interstitials
FAT	Factory Acceptance Test
FEA	Finite Elements Analysis
FJC	Field Joint Coating
FoaK	First of a Kind
FoS	Factor of Safety
FPU	Floating Production Unit. In general meaning herein this specification, it is understood as the larger structure where the hang-off system is attached
GA	General Assembly (Drawing)
HAZ	Heat-Affected Zone



TECHNICAL SPECIFICATION

Nº I-ET-0000.00-0000-290-P9U-005

REV. 0

JOB: GENERAL

SHEET 10 of 43

TITLE: TITANIUM PULL IN TUBE SPECIFICATION

NP-1

SUB/ES/EDD/EDR

HIC	Hydrogen Induced Crack
HSE	Health, Safety and Environment
ID	Internal Diameter
ITP	Inspection and Test Plan
JIP	Joint Industry Project
L.A.S.T.	Lowest Anticipated Service Temperature
MIP	Manufacturing Inspection Procedure
MPS	Manufacturing Procedure Specification
NCR	Nonconformity Report
NDT(NDE)	Non-destructive Test (Non-destructive Examination)
OD	Outer Diameter
OoS	Out of Scope of Work\ Supply
P/N (S/N)	Part Number (Serial Number)
pAUT	Phased Array Ultrasonic Test
PEP	Project Execution Plan
PO	Purchase Order
PoD	Probability of Detection
PPT	Pre-Production Test
PQT	Procedure Qualification Test
PT	Liquid Penetrant Test
QA	Quality Assurance
QC	Quality Control
QHSE	Quality Health, Security and Environment
QTS	Qualification Test Sample
Ra	Arithmetic Average Value of a Filtered Surface Roughness Profile
RP	Return Period
Rt	Maximum Height of the Roughness Profile (Range)
SCF	Stress Concentration Factor
S.I.	International System of Units (<i>Fre. Système International</i>)
SMYS	Specified Minimum Yield Stress
SMTS	Specified Minimum tensile Stress
SSC	Sulfide Stress Cracking
TSA	Thermal Sprayed Aluminum
TIPT	Titanium Stress Joint
ULS	Ultimate Limit State
UNS	Unified Numbering System
UT	Ultrasonic test
WPQT	Welding Procedure Qualification Test

3. REFERENCES

All equipment supplied under the scope of this specification shall be in conformance to the latest editions of the design codes, standards, and PETROBRAS' documents listed hereafter in this section. In addition to these references, Project Specification shall be considered, and shall take precedence with respect to this specification and references cited herein.

3.1. PROJECT DOCUMENTS

Ref. nº	Document number	Title
[1]	--- ⁽¹⁾	Project Technical Specification for Detailed Engineering
[2]	--- ⁽¹⁾	Project Material Requisition/ Data Basis
[3]	--- ⁽¹⁾	Project ECA Report (Titanium and Steel Sections)
[4]	--- ⁽¹⁾	Project Coating Assessment Specification
[5]	--- ⁽¹⁾	Project Support–Tube Drawing
[6]	--- ⁽¹⁾	TRMS Material Requisition/ Data Basis

⁽¹⁾ Project reference number to be informed within a Project Document List, to be released during BID phase.

3.2. PETROBRAS'S REFERENCES

Ref. nº	Document number	Title
[7]	HOLD ⁽³⁾	I-Tube Drawing
[8]	I-DE-3000.00-1300-279-PPC-530 ⁽³⁾	Multifunctional Bell Mouth Assembly DN 48"
[9]	I-DE-3010.00-1300-279-PPC-300 ⁽³⁾	Bell Mouth Diverless Assembly
[10]	HOLD ⁽³⁾	Riser Modular Support Tube
[11]	I-ET-0000.00-0000-290-P9U-004	Titanium Stress Joint Specification
[12]	I-ET-0000.00-0000-274-P9U-001	SLWR Detailed Structural Design Requirements
[13]	I-ET-3000.00-5529-850-PEK-003	TiPT Riser Monitoring System (TRMS) – Full Scope
[14]	I-ET-0000.00-6000-970-PSQ-001	Procedure and Personnel Qualification and Certification
[15]	ET-3000.00-1500-251-PAZ-001	Fixadores em Aço de Alta Resistência para Utilização Submarina
[16]	ET-3000.00-1500-251-PAZ-002	Rastreabilidade de Fixadores em Aço de Alta Resistência para Utilização Submarina
[17]	I-DE-0000.00-0000-140-P56-001	Riser Top Connector Mock–up Geometry Reference
[18]	I-ET-0000.00-0000-219-P9U-004	CRA Weld Overlay Clad Pipe Requirements

[19]	I-ET-0000.00-0000-210-PSQ-001	Alternative Flaw Acceptance Criteria of Submarine Rigid Pipeline and Riser Welds
[20]	SwRI Project No. 18.16696	JIP SwRI Final Report. "Fatigue and Fracture Performance Evaluation of Welded Ti 29 Tapered Stress Joints". 2015.

⁽³⁾ Project selected Support–Tube and specific drawings(s) to be informed during BID phase.

3.3. DET NORSKE VERITAS (DNV)

Ref. nº	Document number	Title
[21]	DNVGL–ST–F101	Submarine Pipelines Systems
[22]	DNVGL–ST–F201	Dynamic Risers
[23]	DNVGL–RP–F108	Assessment of flaws in pipeline and riser girth welds
[24]	DNV–RP–F201	Design of Titanium Risers
[25]	DNVGL-RP-F111	
[26]	DNV RP C203	Fatigue Strength Analysis of Offshore Steel Structures Dnv Recommended Practice
[27]	DNVGL-RP-A203	Technology Qualification
[28]	DNV 2.7-1	DNV Standard for Certification No. 2.7-1 Offshore Containers

3.4. AMERICAN PETROLEUM INSTITUTE (API)

Ref. nº	Document number	Title
[29]	API STD 1104	Welding pipelines and related facilities
[30]	API RP 2RD	Design of Risers for Floating Production Systems (FPSs) and Tension-Leg Platforms (TLPs)
[31]	API SPEC 6A	Specification for Wellhead and Christmas Tree Equipment
[32]	API 5L	Specification for Line Pipe

3.5. NATIONAL ASSOCIATION OF CORROSION ENGINEERS (NACE)



Ref. nº	Document number	Title
[33]	ISO 15156-3	Materials for use in H ₂ S-containing environments in oil and gas production – Part 3: Cracking-resistant CRAs (corrosion-resistant alloys) and other alloys
[34]	NACE TM 01-77	Laboratory Testing of Metals for Resistance to Sulfide Stress Cracking and Stress Corrosion Cracking in H ₂ S Environments

3.6. AMERICAN SOCIETY OF TESTING AND MATERIALS (ASTM)

Ref. nº	Document number	Title
[35]	ASTM A388M	Standard Practice for Ultrasonic Examination of Steel Forgings
[36]	ASTM E1290	Standard Test Method for Crack Tip Opening Displacement (CTOD) Fracture Toughness Measurement
[37]	ASTM E709	Standard Guide for Magnetic Particle Testing
[38]	ASTM E2375	Standard Practice for Ultrasonic Testing of Wrought Products
[39]	ASTM E8	Standard Test Methods for Tension Testing of Metallic Materials
[40]	ASTM B348	Standard Specification for Titanium and Titanium Alloy Bars and Billets
[41]	ASTM B861	Titanium and Titanium Alloy Seamless Pipe
[42]	ASTM B381	Titanium and Titanium Alloy Forgings
[43]	ASTM B499	Standard Test Method for Measurement of Coating Thicknesses by the Magnetic Method: Nonmagnetic Coatings on Magnetic Basis Metals
[44]	ASTM E797	Standard Practice for Measuring Thickness by Manual Ultrasonic Pulse-Echo Contact Method
[45]	ASTM A194	Standard Specification for Carbon Steel, Alloy Steel, and Stainless Steel Nuts for Bolts for High Pressure or High Temperature Service, or Both
[46]	ASTM E1820	Standard Test Method for Measurement of Fracture Toughness
[47]	ASTM G1	Standard Practice for Preparing, Cleaning, and Evaluating Corrosion Test Specimens
[48]	ASTM E466	Standard Practice for Conducting Force Controlled Constant Amplitude Axial Fatigue Tests of Metallic Materials
[49]	ASTM E647	Standard Test Method for Measurement of Fatigue Crack Growth Rates
[50]	ASTM E1220	Standard Practice for Visible Penetrant Testing Using Solvent-Removable Process

3.7. AMERICAN SOCIETY OF MECHANICAL ENGINEERS (ASME)

Ref. nº	Document number	Title
[51]	ASME Section VIII	ASME Boiler & Pressure Vessel Code, Rules for Construction of Pressure Vessels
[52]	ASME Section V	ASME Boiler & Pressure Vessel Code, Section V: Non-destructive Examination

	TECHNICAL SPECIFICATION	Nº I-ET-0000.00-0000-290-P9U-005	REV. 0
	JOB: GENERAL		SHEET 14 of 43
	TITLE: TITANIUM PULL IN TUBE SPECIFICATION		 SUB/ES/EDD/EDR

[53]	ASME Section IX	ASME Boiler & Pressure Vessel Code, Section IX: Welding and Brazing Qualifications
------	-----------------	--

3.8. OTHER STANDARDS

Ref. nº	Document number	Title
[54]	EN ISO 13628-7:2006	Petroleum and natural gas industries — Design and operation of subsea production systems — Part 7: Completion/workover riser systems
[55]	EN 1779	Non-destructive testing. Leak testing. Criteria for method and technique selection
[56]	ISO 12736	Petroleum and natural gas industries — Wet thermal insulation coatings for pipelines, flow lines, equipment and subsea structures
[57]	BS 7910	Guide to methods for assessing the acceptability of flaws in metallic structures
[58]	AMS 2380	Approval and Control of Premium-Quality Titanium Alloys
[59]	NORSOK Standard L-005	Compact Flanged Connections

3.9. CONFLICT OF INFORMATION AND DOCUMENT APPROVAL

In the event of any conflict between this specification or any other specification and associated requisition forms, or with any of the applicable codes and regulations arise, written clarification shall be sought from PETROBRAS before proceeding with the Work. SUPPLIER shall provide PETROBRAS with a written request of clarification. PETROBRAS' decision shall be final regarding interpretation of requirements.

All deviations to this specification and other referenced specifications or attachments listed in this specification shall be made in writing and shall require written approval by PETROBRAS prior to the execution of the Work.

The Stress Joint shall be designed and manufactured in accordance with the regulations applicable for service offshore Brazil.

4. GENERAL REQUIREMENTS

4.1. MATERIAL SUPPLIED

In general terms, it is anticipated that the supplied Titanium Stress Joint will consist of the basic components listed in Table 5.1 (to be confirmed within the contractual documents).



Table 5.1 – Scope of Supply (Breakdown)

Item	Description	Application	Qty per Type
1	Titanium Pull in Tube Stack-up	Permanent Equipment	[2], [6], [13]
1.1	Lower Titanium Stress Joint Monolithic Titanium Body (UNS R56404/UNS R56407) w\ integral compact flanges in both ends.		
1.2	Upper Titanium Stress Joint Monolithic Titanium Body (UNS R56404/UNS R56407) w\ integral compact flanges in both ends.		
1.3	Titanium Spacer Pipe (UNS R56404/UNS R56407) w\ integral (unwelded) compact flanges in both ends.		
1.4	Steel Transition Spool, with FPU interface flange and FBG sensors		
1.5	Lower CS Compact Flange w/ weld prepped neck.		
2	Adaptor Cap (Steel) to Interface with Support–Tube^(NOTE 1)	Permanent Equipment	[2]
2.1	Steel Cap, with holder and fuse cables (installation aid items)		
2.2	Trumpet (steel) internally coated		
3	Hang–off Assembly	Permanent Equipment	[2]
3.1	Bipartite Hang–off Flange		
3.2	Bipartite Stopper		
4	Steel Pup Piece (w\ FBG and IMU sensors) for riser first weld	Permanent Equipment	[2], [6], [13] (NOTE 2)
5	TRMS w\ fibers and cables underneath TiPT coating (some section), FBG, IMU sensors, and other items.		
6	Other Supply Items		
6.1	Dummy End Fitting (Mock–up) simulating the interface flange with the FPU, for adjustment of the FPU closing spool (elevation “A”, Figure 8.1). ^(NOTE 3)	Construction Accessories	[2]
6.2	Handling pull-in/out device w/ seal ring, bolts and nuts	Handling Accessories (Optional)	[2]
6.3	Gasket rings for final topside spool assembly	Permanent Equipment (Optional)	[2]
6.4	Studs and nuts for final topside spool assembly	Permanent Equipment (Optional)	[2]

NOTE 1: Steel cap with cathodic protection system (anodes), to interface to the internal surface of the Project Selected Support–Tube.

NOTE 2: A steel riser pipe or a forged tapered pipe (exceptional case) to be preferably factory welded to the Lower Steel Compact Flange by SUPPLIER. The Pup Piece shall have the same material requirement of the riser pipe in term of dimension (pipe ends) and metallurgy.

NOTE 3: Mock–up to be used by FPU constructor for top closing spool adjustment in the yard during construction. This mock–up shall be provided with a blind flange with the same specification as

	TECHNICAL SPECIFICATION	Nº I-ET-0000.00-0000-290-P9U-005	REV. 0
	JOB:	GENERAL	
	TITLE:	TITANIUM PULL IN TUBE SPECIFICATION	
		SHEET 16 of 43	
		SUB/ES/EDD/EDR	

the TIPT interface standard flange per ref. [2] (including N₂ test port if specified). The mock-up shall be able to withstand a leak test for the topside hard pipe, with the same pressure of the riser hydrostatic test (according to ref. [2]). This construction accessory is not required for retrofit into existing FPU.

4.2. MATERIAL SELECTION

All equipment and material supplied under this Specification shall be new, of proven design, and in accordance with sound engineering fabrication and manufacturing practice. It is preferred to use existing designs or modifications that have been already accepted.

SUPPLIER shall be responsible for the selection of the materials. All materials shall be suitable for the intended service. The selected materials shall be in accordance with the relevant applicable codes, standards and specifications and be able to meet the requirements defined in [2].

The origin and manufacture of all materials used in the manufacture shall be clearly identified. SUPPLIER shall submit any required material manufacturing process details, tests, examinations, inspections, and acceptance criteria for review and approval by PETROBRAS.



SUPPLIER shall select the materials in accordance with the:

- Relevant codes listed in this document and related Project specifications;
- Results of both the structural and the fatigue analysis;
- Maintenance-free requirement during the service life, as per Project specifications;
- Corrosion control;
- Environmental conditions (fluids in contact with TIPT).

The compatibility between all materials shall be checked. Materials shall not be affected by galvanic reactions and can be welded to other specified metallic pieces where necessary. In particular, the adequacy of the compact flange pairs and the nearest steel pipe sections are critical. Requirements can be found in section 7.15 and within Project Specification.

If SUPPLIER intends to consider the weld overlay layer contributing to the strength of the dynamic steel parts (Lower CS Compact Flange and Pup Piece), additional requirements of the DNV Report for JIP Lined and Clad Pipelines, Phase 3 - Design and Construction of Lined and Clad Pipelines [18], and Appendix A.3 of [21], shall be fulfilled.

Additional criteria for weld overlay are presented on section 9.2.

	TECHNICAL SPECIFICATION	Nº I-ET-0000.00-0000-290-P9U-005	REV. 0
	JOB: GENERAL	SHEET 17 of 43	
	TITLE: TITANIUM PULL IN TUBE SPECIFICATION	 SUB/ES/EDD/EDR	

4.3. SUPPLIER'S RESPONSIBILITIES

SUPPLIER shall furnish all labor, consumables, tools, equipment and materials (other than those explicitly identified as supplied by PETROBRAS) required to manufacture, test and deliver the Stress Joint in a safe manner per the agreed schedule. SUPPLIER shall perform all operations required for design, manufacture, inspection, testing, handling and shipping.

Nothing contained in this specification or omitted from it shall be construed as relieving the SUPPLIER of the obligation to supply the Stress Joints in accordance with the functional requirements outlined herein, said to be capable of functioning properly in a riser system for the entire design period specified by PETROBRAS for the Project, without need for replacement of any of its parts.

SUPPLIER shall develop a written Manufacturing Plan/Procedure, which includes a Quality Control Plan, which shall be submitted to PETROBRAS for approval prior to commencement of material procurement and manufacturing.

A pre-production meeting shall be held between PARTIES representatives, plus any third-party inspection personnel involved. The purpose of the meeting is to ensure that all parties involved fully understand job requirements and resolve any outstanding issues prior to commencement of manufacturing.

PETROBRAS furnished drawings and specifications shall be checked by SUPPLIER immediately upon receipt, and SUPPLIER shall promptly notify PETROBRAS of any discrepancies therein.



For any requirement in question by SUPPLIER, it shall be SUPPLIER's responsibility to:

- Obtain clarification from PETROBRAS, which shall be final and binding;
- Review and resolve conflicts with PETROBRAS prior to initiation of Work or continuation of Work.

SUPPLIER shall allow PETROBRAS reasonable access to all areas concerned with design, manufacture, inspection and testing during all times while Work is being performed for this order.

SUPPLIER shall provide all reasonable facilities to PETROBRAS inspectors, without charge, to satisfy the inspector that product is manufactured in accordance with this Specification. Such facilities shall include, but not limited to, office equipment and telecommunication equipment. CONTRACTOR shall perform a complete visual inspection at the place of manufacture prior to shipment, and upon the receipt of the TIPT at the construction site. If any inspection or testing reveals details not in accordance with this Specification, then SUPPLIER may demonstrate to PETROBRAS that the product still satisfies the design requirement. If SUPPLIER is unable to demonstrate this to PETROBRAS's satisfaction, then the manufacturing and/or testing procedure shall be repeated until compliance is demonstrated. All such remedial work shall be performed at SUPPLIER's cost.

SUPPLIER shall furnish all data generated during the design cycle of the Titanium Stress Joint including the results of the numerical analyses that will be carried out in order to fulfill the design

	TECHNICAL SPECIFICATION	Nº I-ET-0000.00-0000-290-P9U-005	REV. 0
	JOB:	GENERAL	
	TITLE:	TITANIUM PULL IN TUBE SPECIFICATION	
		SHEET 18 of 43	
		SUB/ES/EDD/EDR	

requirements. This documentation shall be comprised of written report, in a layout defined by the PETROBRAS, and the electronic input and output files of the finite element and ECA analysis.

Equipment used for the manufacture shall be of proven design and in good operating condition.

Methods employed shall be in accordance with prudent engineering, fabrication and construction practice.

All costs including taxes are to the SUPPLIER account in undertaking the responsibilities.

Deviations from this Specification are not permitted. All proposed changes or modifications to this Specification shall be submitted in writing for PETROBRAS approval. Approved changes shall be incorporated into a revised, approved purchase specification. Disclaimers are not permitted.

4.4. PRODUCT QUALIFICATION

Qualification of the product for the intended service is essential. Refer to section 12 for qualification requirements of TiPT components.



4.5. UNIT OF MEASUREMENTS

All data shall be reported in primary S.I. units; however, customary US units may also be reported for reference only.

5. FUNCTIONAL REQUIREMENT

5.1. TIPT ASSEMBLY

- The TiPT shall be design and sized in a way to guarantee that its titanium portion will be composed by monolithic pieces. Weld on titanium parts shall be avoid;
- The TiPT assembly shall provide a secure attachment of the riser to the hull under all specified load conditions;
- The TiPT assembly shall fit together so that under load there is no relative movement between mating parts;
- The TiPT assembly shall be attached to the riser before installation into the hull's riser hang-off;
- The TiPT assembly shall transfer all specified load conditions without gross yielding, buckling or failing during the specified service life;
- During a catastrophic event, the TiPT assembly design shall provide that failure is likely to occur in the riser pipe rather than the TiPT assembly or hull structure;

	TECHNICAL SPECIFICATION	Nº I-ET-0000.00-0000-290-P9U-005	REV. 0
	JOB:	GENERAL	
	TITLE:	TITANIUM PULL IN TUBE SPECIFICATION	
		SHEET 19 of 43	
		SUB/ES/EDD/EDR	

- The TiPT assembly shall be designed to withstand a constant hydrostatic pressure at specified installation maximum water depth, including pre-abandonment if required, for a minimum of six (12) months;
- The TiPT assembly shall provide an electrically isolating barrier between the riser and the FPU hull, preventing the riser CP from draining into the hull structure;
- The TiPT assembly, mainly in the interface with dissimilar metallic parts, shall be protected from galvanic potential to prevent the formation of hydrides. Especially attention shall be taken at the Compact Flanges connections;
- The TiPT flanges shall maintain a leak tight connection under all specified load conditions using a metal HX seal ring as the primary pressure barrier;
- The TiPT flanges shall provide a fatigue resistant connection by transmitting no more than 5% of the riser dynamic loading into the flange studs/nuts. The 95% balance of the riser's dynamic loading shall be carried in the pre-loaded flange faces;
- The TiPT flanges shall be designed to avoid yielding of the titanium material for all combinations of make-up and operational loads;
- The TiPT upper flange mating to platform piping shall be designed to carry riser installation loads.

5.2. ADAPTOR CAP SET

HOLD



5.3. STEEL TRANSITION SPOOL

HOLD

5.4. COMPACT FLANGES

SUPPLIER shall provide the data sheet of the selected compact flanges, as per [59], for the interfaces with the FPU spool and with the riser. Information includes commercial\standard designation (or detailed drawing for modified design), material, sealing type, qualified loads envelope capacity.

Calculation report shall be elaborated, containing capacity calculation with strength and fatigue assessments (bolts and flange), as per annex A of **Erro! Fonte de referência não encontrada.** and also a sealing effectiveness assessment (primary seal contact pressure).

	TECHNICAL SPECIFICATION	Nº I-ET-0000.00-0000-290-P9U-005	REV. 0
	JOB: GENERAL		SHEET 20 of 43
	TITLE: TITANIUM PULL IN TUBE SPECIFICATION		 SUB/ES/EDD/EDR

5.5. EXTERNAL COATINGS

External coatings such as Thermoplastic Polyurethane shall be used on 100% of the exposed surface of titanium parts to afford complete electrical isolation of titanium parts from the electrolyte, and galvanic shielding from steel components to which the Stress Joint is connected in service.

SUPPLIER shall comply with the requirements for the external coating of titanium and steel parts presented in [4].

For risers with maximum operating temperature closer to the selected material limit, a thermal analysis shall be done to determine the temperature profile through the rubber coating thickness to be compared with the material qualified limit.

Field joint coating on titanium section (HOLD)

TiPT Steel Parts (HOLD)

Pup piece (HOLD)

5.6. TIPT RISER MONITORING SYSTEM (TRMS)

HOLD

5.7. INSTALLATION AND PRE-COMMISSIONING

HOLD

6. MATERIAL REQUIREMENTS



Material requirements and guideline for steel and titanium material selection for TiPT components shall follow sec. 6.1 of ref. [11].

7. DESIGN REQUIREMENT

7.1. GENERAL

SUPPLIER shall design and construct the TIPT to accommodate the specified values for angular rotation, axial loads, temperatures, and pressures for the specified service life within allowable stress limits specified in [30]. PETROBRAS will provide the riser design basis covering the entire riser system including the TIPT, as per Section 3.1.

The design requirements applicable to the Stress Joint shall include, but not be limited to the following:

	TECHNICAL SPECIFICATION	Nº I-ET-0000.00-0000-290-P9U-005	REV. 0
	JOB: GENERAL		SHEET 21 of 43
	TITLE: TITANIUM PULL IN TUBE SPECIFICATION		 SUB/ES/EDD/EDR

- The TIPT design shall conform to the chemistry of fluids passing through the risers. The Stress Joint shall be designed for sour service per [33] requirements, if sour service is expected as per [2].
- Titanium studs of the Compact Flanges shall be electrically isolated from the flange (Ti and CS), for instance by mean of ceramic coating applied on the face of the nuts in contact with the flanges, and dielectric material installed in the holes. If high strength steel studs are approved to be used, then electrical contact with the CS side of the flange shall be guaranteed, as per section 7.15.
- The TIPT shall transfer all loads at their maximum design limits without gross yielding, buckling, collapsing, or failing during the specified service life.
- The Stress Joint lower connection Pup Piece shall be designed to be compatible with the riser pipe, both in term of material and dimension.
- The TIPT shall accommodate the riser cyclic load without failure for a fatigue life greater than the Project service life factored by 10. The combined fatigue life will include contributions due to installation and wave induced fatigue. SUPPLIER shall get approval from PETROBRAS regarding parameters, techniques, and programs used for the FEA and fatigue analysis prior to starting either FEA or fatigue analysis.
- The fabrication of the TiPT shall be subject to inspection, verification, qualification, and documentation in accordance with PETROBRAS's and industry standards.
- The TiPT assembly shall successfully pass the factory acceptance testing (FAT). Tests specification and criteria shall be submitted to PETROBRAS comment prior to the stars of FAT.
- SUPPLIER shall submit a complete Design Report and general arrangement drawings to PETROBRAS for review and approval.

7.2. INTERFACES

HOLD

7.2.1. INTERFACE WITH LOWER RISER BALCONY

HOLD

7.2.2. INTERFACE WITH UPPER RISER BALCONY

HOLD

7.2.3. INTERFACE WITH THE STEEL RISER

HOLD

7.3. DIMENSIONS

7.3.1. GENERAL

The Adaptor Cap shall match with the dimensions of the Project selected Support-Tube of ref. [7] to ref. [10], with the annular gap prescribed in (HOLD). Fabrication tolerances of the external profile of the TIPT and contacting areas of the Trumpet including coatings shall be considered, as well as the calculated lateral expansion due to the riser tension. Interference/assembly study shall be performed.

The design of the LTSJ shall assure free rotation of the lower Extension (without contact with the FPU Hull Structure) over the maximum Project specified angular deflection. Support-Tube mounting angle tolerance, as per (HOLD), shall be considered.

The Pup Piece riser end dimension and tolerances shall be considered in view of welding requirements (Hi-Lo), and coating requirements (coating cutback characteristic).

In case different internal diameters are specified for the riser bore and for the top connection spool (FPU interface) in ref. [2] a smooth 1 : 5 slope diameter transition shall be provided, in the Transition Spool.

7.3.1.1. LENGTH ADJUSTMENT (“CUT-TO-LENGTH”)

HOLD

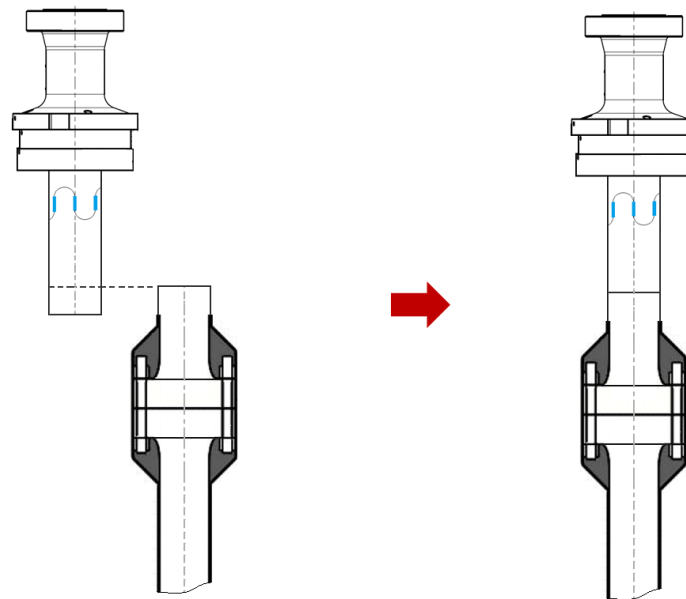

Figure 7.1 – Interface Flange elevation “A” above Upper I-Tube.

7.3.2. UPPER BALCONY

The specified interface flange elevation “A” above the Upper I-Tube flange, are given in [2] for each TIPT type (see Figure 7.2). SUPPLIER/ CONTRACTOR shall consider these values on the TIPT design, and inform PETROBRAS, during clarifications in BID phase, if this requirement cannot be fulfilled.

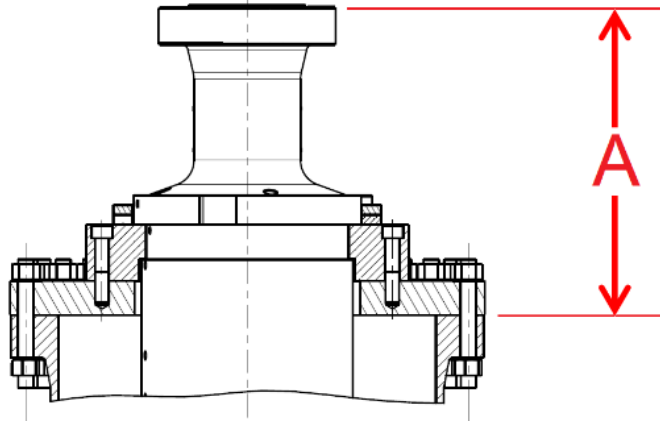

Figure 7.2 – Interface Flange elevation “A” above Upper I-Tube.

7.3.3. LOWER BALCONY

HOLD

7.4. DESIGN LOADS

From the global riser analysis and environmental conditions, PETROBRAS or CONTRACTOR will provide the riser interface loads at the Stress Joint termination locations, including maximum tension, maximum bending moment (or bending angle with respect to the center of rotation in the hang-off), and fatigue tension/ angle histograms, as required.

SUPPLIER then shall size the TIPT according to the load cases provided by PETROBRAS or CONTRACTOR and return with the size and critical section locations along the TIPT (taper transition), so the abovementioned histograms can be correctly informed. SUPPLIER shall provide also the interface load (i.e. reacting moment on the hang-off), and the TIPT and Adapter Bushing geometry, as 3D CAD model, and the exact position of the point of application of forces to PETROBRAS to subsidize the design of the hang-off design.

7.5. LOADING CASES

Table 7.1 indicates the minimum set of design cases to be considered in the structural design of titanium and steel parts from each Stress Joint type for the Project. Ref. [2] summarizes all these

load cases. The responsibilities about the emission of the final data set for TIPT design is presented on section 1.2. The complete set of load combinations for riser global analysis is listed in [12].

Table 7.1 – Design Loading Case Matrix for Stress Joint.

Design Case	Load Category	Description	Load Combination from Riser Global Analysis, [12]	Design Loads	Cf ⁽¹⁾ [30]
1	Maximum Operating	10 years return period storm	ULS3	[2]	1.0
2	Extreme 1	100 years return period storm	ULS2		1.2
3	Extreme 2	1 year RP. Incidental Pressure	ULS4		1.2
4	Extreme 3	1 year RP. One mooring line broken ⁽²⁾	Max. [ALS1, ALS2]		1.2
5	Survival	1 year RP. Flooded Hull Compartment ⁽³⁾	ALS3		1.5
6	Temporary	Installation ⁽⁴⁾	-		1.2
7	Fatigue (Sec. 7.8)	Fatigue conditions (wave with associated annual current distribution)	-		N/A

(1) The Cf factor is the design case factor used to calculate allowable stresses, as per [30]. Load categorization may vary depending on chosen design code.

(2) Load category to account for the maximum FPU drift.

(3) Load category to account for the maximum accidental top angle.



(4) Installation cases to be defined by CONTRACTOR. Max. installation water depth according to [2].

The selection of load cases to be analysed, for the design case 1 to 4 of Table 8.1, shall be performed in accordance with section 7.1 of [12]. One plot of “Tension x bending moment” shall be presented for each load category of Table 8.1 and shall include all results from global analysis and the selected load cases in order to demonstrate that the selected ones are representative of the whole set of results. At least the load cases with the maximum resultant bending moment and the maximum tension values shall be selected (with the respective associated tension and angle values).

Additional load case(s) other than those cases listed in Table 7.1 may be included, to account for any specificities of a given Project. Any Project extra load case condition will also be clearly defined within Project documentation in [2].

The mounting angle tolerance of the receptacle at the FPU, defined in, shall be considered as an additional permanent deflection of the TIPT, and shall be considered in a conservative form.

Any difference from riser angles and the TIPT mounting angles shall be included by CONTRACTOR in global analysis models.

	TECHNICAL SPECIFICATION	Nº I-ET-0000.00-0000-290-P9U-005	REV. 0
	JOB: GENERAL	SHEET 25 of 43	
	TITLE: TITANIUM PULL IN TUBE SPECIFICATION	 SUB/ES/EDD/EDR	

7.5.1. Interface Loads

Any relevant interface loads due to top flange connection (FPU spool or attached equipment if any), provided by PETROBRAS in ref. [2], shall be used as input data for structural design of Stress Joint.

Beside the loads, SUPPLIER shall perform local analysis of the interface between the Adapter Bushing and the Project selected standard receptacle, with appropriate friction coefficient on the contacting areas and the annular gap specified in section 7.3. Eventual tilting angle of the TIPT axis with respect to the receptacle axis, if it happens, for example during extreme or accidental events (survival load case), shall be reported.

Information of the actual receptacle and box structure complete dimension, as well as confirmation of the analyses criteria used for porch design, could be provided by PETROBRAS if demanded by SUPPLIER, to assist SUPPLIER in the TIPT design. SUPPLIER is not responsible for receptacle and porch structure design.



7.6. DESIGN CRITERIA

TIPTs typically have D/t ratios below 10 as well as concentrated stresses in locations along the taper. The use of elastic stress analysis and stress classification per [30] to demonstrate structural integrity can produce non-conservative results in these sections. A complete finite element analysis shall be made of all components that contribute to TIPT strength capacity and sealing capability.

Annex D of [54] provides guidelines for finite element analysis and establishes TIPT design criteria for both elastic and elastic-plastic stress analysis for steel parts. Plastic deformation on titanium parts shall not be considered.

In addition to comparing the TIPT stresses to the allowable criteria for the riser design load cases, it may also be useful to compare riser limit loads to the ultimate capacity of the hang-off system to ensure a systematic and controlled failure sequence during a catastrophic event. For example, during a catastrophic event the riser should be designed to fail before the hang-off system or hull structure reach ultimate capacity. The design of riser hang-off structures is not specifically covered by current industry codes. However, the ultimate capacity methodology given in [54] Annex D may be applied. For example, ultimate capacity of the Adaptor Cap may be defined as any of the following (derived from guidelines in [54] Annex D.2.4):

- Principle strain exceeds 2% across entire primary structural section;
- Equivalent plastic strain exceeds 10% or $0.5x \left(1 - \frac{\sigma_y}{\sigma_u}\right)$ at any point in the structural section;
- Global structural instability, excessive receptacle deformation or plastic collapse is reached.

	TECHNICAL SPECIFICATION	Nº I-ET-0000.00-0000-290-P9U-005	REV. 0
	JOB: GENERAL	SHEET 26 of 43	
	TITLE: TITANIUM PULL IN TUBE SPECIFICATION	 SUB/ES/EDD/EDR	



7.7. FATIGUE REQUIREMENTS

- SUPPLIER shall furnish the TIPT stress concentration factors to be applied in the riser global model, with the respective calculation sheets.
- SUPPLIER shall submit to PETROBRAS the intended criteria to be used for fatigue analysis (fatigue curves) for titanium and steel parts.
- Supplier pre-qualified titanium fatigue design curves may be used, following PETROBRAS review and approval as per section 12. In case SUPPLIER design titanium S-N curve is not present or not approved for use in the Project, the base case curve from the JIP [20] shall be employed, valid for both sweet\ sour service, internal\ external fiber and base metal\ weld sections, and for grade 23 and 29. Such curve is defined by $N \times \Delta\sigma^6 = 2.87 \times 10^{19}$ (with $\Delta\sigma$ in MPa).
- Lower weld S-N curves in air from [26] may be used, if possible given the stress levels, seeking to make UT inspections more feasible.
- The design S-N fatigue life calculated for the TIPT shall exceed the specified Project service life factored by a FoS of 10.
- Storm waves contribution on TIPT and riser welds fatigue life shall be included within the fatigue analyses. The most damaging extreme waves at the Top of Taper section, for each return period, shall be selected and included among the operational fatigue waves, as per section 7.1.2 of [12].

7.8. FATIGUE ANALYSIS

CONTRACTOR shall determine fatigue life and generate stress histograms for the critical sections along the TIPT. These sections are project specific and shall be defined on the project's TIPT general arrangement drawings. These reference sections shall be located at the top of taper, the start of taper, the Ti Compact Flange and steel weld sections. The corresponding SCF on the outer surface shall be calculated by FEA for each of these sections.

NOTE: During bidding phase of EPCI contracts, PETROBRAS may provide stress histograms based on Basic Design analysis, in the format and for assumed critical section positions given in the ref. [2]. These histograms consider wave-wind-current combination at Project location and may include "storm conditions" and extreme current events, to subsidize preliminary assessment. SUPPLIER may use these histograms and positions as references to interpolate the static and cyclic stresses to the corresponding TIPT geometry to be pre-dimensioned for the Project. The responsibility for the emission of final fatigue data is according section 1.2.

	TECHNICAL SPECIFICATION	Nº I-ET-0000.00-0000-290-P9U-005	REV. 0
	JOB:	GENERAL	
	TITLE:	TITANIUM PULL IN TUBE SPECIFICATION	
		SHEET 27 of 43	
		SUB/ES/EDD/EDR	

7.9. ECA REQUIREMENTS

SUPPLIER shall perform a fatigue assessment based on fatigue crack growth calculations so that maximum initial defect height size left after fabrication and non-destructive testing would not grow to a critical size during service life. A ECA procedure shall be elaborated according to [19], [22], [23], [30] and [57] and submitted to PETROBRAS for approval. The target life for the fracture mechanics evaluation of TIPTs shall be the design service life, as per [2], factored by:

- a DFF_{ECA} of 5 where the assumed initial defect can be reliably derived from PoD 90%/95% and sizing error of the NDT in place according to [19] and [21];
- a DFF_{ECA} of 10 where the assumed initial defect is the expected value of defects (mean) according to [22] and there is limited practical trials on NDT reliability.

Maximum initial defect height sizes depend on flaw length. Detected flaws shall be evaluated considering NDT acceptance criteria and sizing error. Non detected flaws shall be evaluated considering NDT capabilities with a postulated full-circumferential flaw. SUPPLIER shall inform the critical sections where the tension-angle histograms should be informed. Both static and cyclic loading information from the riser global analyst will be provided by PETROBRAS. Tension-angle histograms will be generated with enough fine blocks (bin size) at small values of tension and angle. SUPPLIER shall generate by each section the stress blocks derived from the histograms to be provided by PETROBRAS within [2].

7.10. MAINTENANCE



The Stress joint shall not require any intervention for maintenance or repair during the specified service life. However, the riser shall be removable and re-installable. The Stress joint shall meet this requirement and PARTIES shall work together to generate a procedure for such operation.

SUPPLIER shall provide an inspection and repair procedure for the external elastomeric cover (dry and underwater).

The Stress Joint shall be capable of passing inspection pig as per section 7.12.2.

7.11. IN-SERVICE INSPECTION

PARTIES shall work together to generate a procedure for the periodic inspection confirming the integrity of the Stress Joint and the related components during the service life of the field.

	TECHNICAL SPECIFICATION	Nº I-ET-0000.00-0000-290-P9U-005	REV. 0
	JOB: GENERAL	SHEET 28 of 43	
	TITLE: TITANIUM PULL IN TUBE SPECIFICATION	 SUB/ES/EDD/EDR	

7.12. PIGGING REQUIREMENTS

Stress Joint design shall consider following requirements related to pigging:

- Enable riser cleaning with foam-pigs, brush pigs and magnet-pigs in order to remove residues, according to pre-commissioning procedure;
- Enable riser gauging, consisting of the passage of a bi-directional calliper or pig with gauging plate, as defined in design;
- Enable pigging operations in two directions;
- Internal diameter transitions may be required by PETROBRAS and will be defined in Contractual Documents. In this case, the provisions of section 7.3 shall be considered.
- The Stress Joint shall neither be damaged nor loose its sealing properties because of the pig passage.

NOTE: The TIPT itself will not be subjected to internal inspection with pig but is required to allow unimpeded passage of the various types of pig as stated above. The in-service pig launcher/ receiver will be installed on the top side of the FPU, therefore no disassembly of spool on the TIPT side will be required.



7.12.1. Conventional Pig

The Stress Joint shall be capable of passing disc-type (Mandrel / Solidcast) pigs equipped with wire brushes. SUPPLIER shall review the Stress Joint design based on the overall design criteria and demonstrate to PETROBRAS's satisfaction that this can be achieved.

SUPPLIER's evaluation shall consider the dimension, material and operation of typical disc-type pigs and the minimum pig length required for the pig to pass through the Stress Joint without losing its seal.

7.12.2. Inspection Pig

The Stress Joint shall be capable of passing an ultrasonic or magnetic type inspection pig in both directions. SUPPLIER must review the Stress Joint design based on the overall design criteria to determine if the required angle for pigging is feasible. Any conflict must be resolved during the design process.

	TECHNICAL SPECIFICATION	Nº I-ET-0000.00-0000-290-P9U-005	REV. 0
	JOB: GENERAL	SHEET 29 of 43	
	TITLE: TITANIUM PULL IN TUBE SPECIFICATION	 SUB/ES/EDD/EDR	

7.13. INSTALLATION

SUPPLIER shall assist PETROBRAS during preparation of the Stress Joint installation and handling procedure. SUPPLIER shall review CONTRACTOR's installation and handling procedures.

The selected Installation method (S-, J- or reel-lay), and operational limitation, if any, will be informed by PETROBRAS within Project documentation. SUPPLIER shall inform if additional equipment (e.g. protective shrouds) will be required. PETROBRAS will arrange with the PARTIES a review of the Installation Procedures as they relate to the TIPT.

PETROBRAS, or CONTRACTOR directly, will supply all relevant details of the installation plans and requirements to SUPPLIER for review and comment regarding suitability for use with Stress Joint operational parameters. These details may include the following:

- General installation procedures;
- Commissioning details for the Stress Joint and riser;
- Pre-commissioning pig receiver dimensions;
- Special tool requirements and transfer/ pull in rigging characteristic for installation;
- Requirement for Stress Joint mock-up (optional).



7.14. CONNECTION AND WELDING

The attachment of the riser to the TIPT Extension (Lower CS Compact Flange or steel Pup Piece if any) shall be a butt weld connection (CONTRACTOR scope). SUPPLIER shall assure that the TIPT termination's material and dimensions, including any internal CRA layer and external coating, are compatible with the mating riser components in accordance with the Project Requisition [2].

SUPPLIER shall support weld qualification of the interface weld between the Lower CS Compact Flange and the Pup Piece or the riser pipe by providing material certificates and material samples of the forged steel Compact Flange, if Pup Piece is not included within SUPPLIER scope as per [2]. Additional weld requirement of [1] and related documents shall be observed.

NOTE: SUPPLIER shall not be responsible for performing the weld between the TIPT termination (Lower CS Compact Flange neck or Pup piece) and the riser pipe.

NOTE: The weld test rings should be supplied as prolongation of the same forging of the Lower CS Compact Flange, but it may be supplied from a separate forging, provided that the forging material is from the same heat, undergoing the same manufacturing process, and heat-treated together with the steel Compact Flange.

	TECHNICAL SPECIFICATION	Nº I-ET-0000.00-0000-290-P9U-005	REV. 0
	JOB:	GENERAL	
	TITLE:	TITANIUM PULL IN TUBE SPECIFICATION	
		SHEET 30 of 43	
		SUB/ES/EDD/EDR	

7.15. STEEL PARTS CORROSION PROTECTION

For the TIPT Stack-up steep parts, the requirements of section 8.14 of ref. [11] shall be applied.

For Adaptor Cap (HOLD)

8. MANUFACTURING REQUIREMENTS

Titanium parts requirements for chemical composition, Ingot melting, QTS, heat treatment and mechanical properties shall follow the requirements of section 9 of ref. [11].

9. INSPECTION AND MATERIAL TESTING OF TITANIUM PARTS

Titanium parts requirements for Tensile Testing, Fracture Toughness Testing, Micro and Macrostructure Evaluation and Non-destructive Examinations, as well as Tests Certification and Documentation shall follow the requirements of section 10 of ref. [11].

9.1. STEEL FORGINGS

Requirements for Steel Forgings material and QTS shall follow the requirements of section 10.7 of ref. [11].

9.2. CRA WELD OVERLAY ON STEEL PARTS

Requirements for CRA weld overlay on steel parts shall follow the requirements of section 10.8 of ref. [11].



10. INSPECTION AND MATERIAL TESTING OF STEEL PARTS

Requirements for Inspection and material testing of steel parts shall follow all the requirements of section 11 of ref. [11].

11. COMPONENT TESTING REQUIREMENTS

All components shall pass visual, ultrasonic, and liquid penetrant inspection in accordance with SUPPLIER and this specification prior the assembly of the TIPT. In additional, final visual inspection shall be done on the assembled equipment for conformance to PETROBRAS approved drawings.

All assembly and testing shall be done according to a Company approved Inspection Test Plan (ITP) to ensure quality and safety standards are met.

	TECHNICAL SPECIFICATION	Nº I-ET-0000.00-0000-290-P9U-005	REV. 0
	JOB: GENERAL	SHEET 31 of 43	
	TITLE: TITANIUM PULL IN TUBE SPECIFICATION	 SUB/ES/EDD/EDR	

11.1. FACTORY ACCEPTANCE TEST

Before the final release and packaging, the Stress Joint will undergo final testing and review to assure all pertinent aspects of the design and fabrication are following both the PETROBRAS's specifications and SUPPLIER's design and production requirements.

SUPPLIER shall propose a factory acceptance test program for PETROBRAS acceptance to be carried out in detail on the Stress Joint and a fit-up procedure to demonstrate mating to the receptacles. The factory acceptance test program will include as a minimum requirement the steps outlined in hereunder and shall accomplish the following goals:

- Demonstrate compliance with performance requirements described in this Specification and SUPPLIER design and test specification.
- Detect any unit that fails to meet required performance levels and reject them for release unless the non-conformance can be eliminated through re-qualification or mutual written consent from the PETROBRAS.



The factory acceptance test program shall include as a minimum requirement the steps outlined in hereunder:

- Dimensional check of main, interfacing dimensions;
- Electrical isolation of all studs of the Compact Flanges;
- Electrical isolation test of the external coating;
- Leak test of the assembled Compact Flange, as per sec. 4.6 of [59] and [55];
- Hydrostatic test (as detailed in section 11.1.1).
- Drift test of a dummy Transition Spool through the Trumpet and Support–Tube. Both flanges shall be geometrically represented, and the pull in head and any other device intended to be connected to this part;
- TRMS signal continuity test, as per [13].

SUPPLIER Factory Acceptance Testing (FAT) specification shall include test conditions, procedures, measurements to be taken, and acceptance criteria specifically for the TiPT to be manufactured. The FAT specification shall be reviewed and approved by PETROBRAS prior to initiation of factory acceptance testing.

11.1.1. HYDROSTATIC PRESSURE TEST

Hydrostatic testing, as part of the FAT, shall be performed on the assembled TiPT Stack–up to demonstrate function and integrity. Hydrostatic testing is not required for individual parts. If any part of

	TECHNICAL SPECIFICATION	Nº I-ET-0000.00-0000-290-P9U-005	REV. 0
	JOB: GENERAL	SHEET 32 of 43	
	TITLE: TITANIUM PULL IN TUBE SPECIFICATION	 SUB/ES/EDD/EDR	

the Stack-up needs to be disassembled for any reason, the leak test of the disassembled connections and the hydrostatic test shall be repeated.

Internal hydrostatic tests of the TiPT shall be performed at the pressure specified in ref. [2] and prior to delivery. Agreement shall be obtained with PETROBRAS's representative that pressure stabilization has occurred before proceeding with the hold period of the pressure test. Test duration for all tests shall be a minimum of thirty (30) minutes after pressure stabilization. All components shall be visually inspected for leaks throughout the test period. The test shall be performed in air to allow visual inspection.

Tests shall be performed with end caps installed on both ends of the riser Stress Joints. Following the completion of the test, SUPPLIER shall be responsible for removing the end cap and the associated heat-affected zone (HAZ) from the lower end of the Extension, leaving a clean straight edge ready for beveling, or testing flange.

The fluid media shall be city tap water (fresh water) and the test temperature shall be ambient (outside approx. 20°C). The acceptance criteria for a successful test shall be no pressure drop due to leakage. A pressure drop of 0.5% of the hydrostatic test pressure due to ambient temperature fluctuation is permitted. Pressure recorders and charts shall be utilized.

11.1.2. TEST DOCUMENTATION



Internal pressure test reports shall include, but not necessarily be limited to, the following information:

- Detailed description of test equipment with diagram of test hook-up, and test procedures;
- Test temperature records;
- Test pressure records;
- Test equipment calibration certificates;
- Test results and interpretation;
- Dead weight Pressure Test records.

Calibration certificates (valid within the previous 6 months) shall be supplied for the temperature recorder, the pressure recorder, and the dead weight tester.

11.2. DIMENSIONAL AND VISUAL INSPECTION

All components shall be dimensionally and visually inspected prior to delivery. Rework or modifications shall not be allowed without PETROBRAS approval. All products and forgings shall be visually inspected with 100% surface coverage of all accessible surfaces to be free from visible laps, cold shuts, cracks, porosity, slag, excessive scale, and other surface imperfections.

	TECHNICAL SPECIFICATION	Nº I-ET-0000.00-0000-290-P9U-005	REV. 0
	JOB: GENERAL		SHEET 33 of 43
	TITLE: TITANIUM PULL IN TUBE SPECIFICATION		 SUB/ES/EDD/EDR

11.2.1. DIMENSIONAL INSPECTION

Pipe sections shall be dimensionally inspected or, each end and at the approximate center location for compliance to the PETROBRAS approved. Flanges shall also be dimensionally inspected for compliance to the approved drawing. Reports detailing the actual dimensions shall be provided as part of the MPS.

11.2.2. VISUAL INSPECTION

Pipe, flanges and weldments shall be 100% visually inspected on the entire OD and accessible ID surfaces. Any abnormalities, local grind-outs, etc. shall be recorded and documented. This applies even if the area is within the dimensional tolerances. The relative location, length, width and depth of each abnormality shall be recorded. External rubber cover shall be 100% visually inspected for damage as crack or cuts. Repair of the damaged area, if any, is mandatory.

11.2.3. FASTENERS

Fasteners shall be 100% visually inspected and dimensionally inspected to PETROBRAS approved drawing by the SUPPLIER, as per [15].



12. TECHNOLOGY QUALIFICATION OF TITANIUM PULL IN TUBE

Qualification of the product for the Project intended service is required since:

- No track record of supply/ qualification for conditions similar to the Project is presented;
- New design, novel technology not yet qualified is offered;
- New material not used in the same conditions is used;
- Original qualification test documents are not accessible for revision;
- SUPPLIER fails to demonstrate Third Party involvement, with report or statement, which cover the content of [27] or similar requirements.

SUPPLIER shall demonstrate that all materials proposed for the Stress Joint are compatible with and qualified for the design service conditions (including design temperatures, pressures and the composition of the conveyed fluids and injected chemicals). It shall also be demonstrated the compatibility with FPU and riser material, and corrosion protection system (galvanic and impressed current).

Any relevant document related to product previous qualification program, declared by SUPPLIER as proof of confidence in the design, including test procedures, acceptance criteria and results shall be submitted for PETROBRAS review and comment before the beginning of the Work.

	TECHNICAL SPECIFICATION	Nº I-ET-0000.00-0000-290-P9U-005	REV. 0
	JOB:	GENERAL	
	TITLE:	TITANIUM PULL IN TUBE SPECIFICATION	
		SHEET 34 of 43	
		SUB/ES/EDD/EDR	

All documents related to the qualification of any new product, including test procedures, third party statement, acceptance criteria and detailed qualification plan (including test program and schedule), shall be submitted to PETROBRAS for approval before the beginning of the Work.

CONTRACTOR shall produce a "Qualification Dossier", summarizing the documents mentioned in the paragraph above, to be included within Project's documentation for future references. The dossier shall be submitted to Petrobras, and once accepted, SUPPLIER is able to propose it on the Project.

NOTE: It is worthwhile to mention that, after a Contract award, SUPPLIER shall perform the material qualification tests as per section 8 (for titanium parts) and sections 9.1 and 10 (for steel parts), and the PQT, PPT and Production tests of [4] (for all external metallic and non-metallic coatings).

PETROBRAS acceptance of previous qualification to be presented by SUPPLIER, as well as proposed qualification programs for the Project does not waive SUPPLIER\CONTRACTOR from the responsibility to deliver products perfectly fitted for the Project service, based on Project specification and any other information provided by PETROBRAS.



New or modified design concepts, materials type or grade or analysis/calculation methods shall be qualified. Any design qualification shall be completed prior to the beginning of the Work.

12.1. QUALIFICATION SCOPE

The following qualifications\ tests, considered a minimum requirement for acceptance of the Stress Joint design, shall be performed before Stress Joint supply.

12.1.1. METALLIC PARTS

- Base metal material;
 - Chemical composition (material certificate) as per [42];
 - Chemical compatibility assessment with Project fluids;
 - Tensile test, as per [39] (min. yield stress, min. ultimate stress, elongation, elastic modulus);
 - Tensile test at higher temperature, to determine the de-rating of material properties of yield stress, ultimate stress and E-modulus;
 - Fracture toughness test, as per [46];
 - S-N fatigue testing, as per [48];
 - FCG test, as per [49];
 - Bend test, as per [52];
 - Corrosion test, as per the method A of [34];
 - Density;

	TECHNICAL SPECIFICATION	Nº I-ET-0000.00-0000-290-P9U-005	REV. 0
	JOB: GENERAL		SHEET 35 of 43
	TITLE: TITANIUM PULL IN TUBE SPECIFICATION		 SUB/ES/EDD/EDR



12.1.2. RUBBER COATING

- Supplier to prepare and submit to Petrobras a qualification “dossier” report based on [56]. As the standard [56] is proper to insulation coatings applications Supplier should follow its principles to collect and organize the qualification tests to compose the qualification dossier;
- This dossier shall define the operational limits of the proposed material ;
- To be observed that [56] defines on its section 6 the contents of the qualification dossier and the qualification tests requirements are defined on its section 7, 8 and 9. Supplier should consider that the following tests of [56] are NOT applicable for the rubber coating application:
 - Section 7, Table 1, Thermal conductivity test, Specific heat capacity test;
 - Section 7, Table 2, Abrasion test;
 - Section 7.2.4, all tests;
 - Section 8, all tests;
 - Section 9, Thermal conductivity, Specific heat capacity;
- Supplier shall also clarify by tests or documents the barrier function of the applied rubber material to effect of hydrogen on TIPT;
- Tests not included into “qualification dossier” or considered not valid shall be performed during PQT process;
- The temporary protective coating of the rubber (anti-impact coating) shall be qualified in accordance with [25].

12.1.3. TRMS

- Qualification of the fiber and cabling underneath the coating to withstand the contact pressure during the passage of the TiPT through the Support–Tube, as per ref. [13].

All materials used in the fabrication of the TiPT shall be successfully submitted to qualification testing in accordance with accepted standards or approved SUPPLIER procedures. PETROBRAS shall have access to the material test results for verification prior to commencement of production operations.

	TECHNICAL SPECIFICATION	Nº I-ET-0000.00-0000-290-P9U-005	REV. 0
	JOB:	GENERAL	
	TITLE:	TITANIUM PULL IN TUBE SPECIFICATION	
		SHEET 36 of 43	
		SUB/ES/EDD/EDR	

13. QUALITY CONTROL AND REPORTING

This section defines the quality assurance requirements to be observed in performance of the procedures defined by this specification.

Quality is a prime consideration for ensuring the structural integrity of the Stress Joints. Inspection of the stress joints in service may not be possible and removal of the riser to repair or replace the stress joint would be extremely costly. SUPPLIER shall demonstrate to PETROBRAS's satisfaction that a quality system is in place to ensure that the stress joints will be manufactured per this specification.

Quality management procedures will be routinely performed in every phase of design and manufacture in accordance with the Quality System Manual. Internal quality standards will comply with ISO 9001.

SUPPLIER shall provide details on its Quality Assurance Program to PETROBRAS prior to issuance of a PURCHASE ORDER.

13.1. QUALITY PLAN AND QUALITY CONTROL PLAN

SUB-SUPPLIER shall produce for SUPPLIER review and approval a project quality plan and a project quality control plan:

Project quality plan	Detail the organization, responsibilities, activities, and an index of referenced and applicable procedures to complete the Work, including that of SUB-SUPPLIERS and SUPPLIER.
Project quality control plan (ITP)	Detail quality control plan and control monitoring to be employed during mobilization, acquisition and reporting phases.



All SUB-SUPPLIERS shall address and resolve any audit reports, recommendations and / or corrective action requests issued by the CONTRACTOR to the satisfaction of the CONTRACTOR and of the PETROBRAS.

The criteria of material SUB-SUPPLIER conformity of **Erro! Fonte de referência não encontrada.** shall also be observed.

SUB-SUPPLIERS shall also refer to document "QHSE Management for Suppliers / Subcontractors".

13.2. REPORTS AND RECORDS

Records will be maintained to sufficiently document the performance of each operation required by this specification and to identify all materials used in the processing. These records will be formal documentation (MIPs) containing manufacturing and quality control sign offs for each step of the process. These records are available to the PETROBRAS upon request and are retained by

	TECHNICAL SPECIFICATION	Nº I-ET-0000.00-0000-290-P9U-005	REV. 0
	JOB: GENERAL	SHEET 37 of 43	
	TITLE: TITANIUM PULL IN TUBE SPECIFICATION	 SUB/ES/EDD/EDR	

SUPPLIER for a certain period as Contract Specifications (length of time to be confirmed by PETROBRAS prior to award of contract).



The following procedures, reports and records shall be provided to PETROBRAS for review.



- QA/QC procedures; to be submitted to PETROBRAS for review prior to start of design and production work. The plans and procedures shall include, as a minimum, the following elements:
 - Manufacturing ITPs for PETROBRAS to comment (assign inspection points);
 - Material and Process Qualification Plan;
 - Inspection and Test Reports to be provided including all reports defined in this Specification;
 - NDE Procedures;
 - FAT Procedures;
 - Document Control Procedures;
 - Traceability Plan;
 - Non-conformance Procedure including examples of report form to be utilized.

- Design Basis and Methodology (DBM) to be submitted to PETROBRAS for review prior to start of design and production work, as a minimum, includes the following:
 - Design Parameters;
 - Design methodology including FEA tools to be used as agreed by PETROBRAS;
 - Proposed material specifications;
 - Chemical composition and mechanical properties of titanium and steel components (yield strength, tensile strength, percent elongation, area reduction and other required properties);
 - Component material lists and descriptions, including designation of any Proprietary material, whose technical specification may be revised by PETROBRAS in SUPPLIER premises;
 - List of Design Drawings to be provided;
 - Design calculations and reports for each element to be provided.

In bidding phase, in case of direct purchase by PETROBRAS, the following documentations\ information are requested to be issued (Technical Proposal):

- Technical Review, comprised by:
 - Preliminary GA drawings, with the following minimum information: main dimensions, view showing the assembly to the receptacle with adapter bushing and the maximum free angle, and confirming elevation "A" of Figure 8.1, as per ref. [2];
 - A summary list of material selection of main parts (flanges, other forgings, Pup Piece pipe, Adapter Bushing, fasteners, coating);

	TECHNICAL SPECIFICATION	Nº I-ET-0000.00-0000-290-P9U-005	REV. 0
	JOB:	GENERAL	
	TITLE:	TITANIUM PULL IN TUBE SPECIFICATION	
		SHEET 38 of 43	
		SUB/ES/EDD/EDR	
<ul style="list-style-type: none"> ○ Cladding and NDT Procedure Proposal; ○ External coating specification (preliminary); ○ Technical notes (Qualification Dossier) of previous design and material qualification tests, as per section 12; ○ Any technical clarification and alleged exceptions or request for requirement deviation from Project Specifications (this included); ○ Mock-up drawing (preliminary), indicating the typical tolerances (gaps) between TIPT Adapter Bushing and receptacle cast in accordance with [17] (optional, see Table 5.1); ○ Pull in head description (optional, see Table 5.1). <ul style="list-style-type: none"> • Typical Manufacturing Plan/ Procedure; • Typical Quality Control\ Management Plan; • HSE • Typical ITP; • Typical NCR form; • SUB-SUPPLIERS list; <p>The final documentation of the detailed Project shall include:</p> <ul style="list-style-type: none"> • Qualification Dossier, covering the items in section 12; • Design Basis and Methodology; • Design Report; • Material compatibility (galvanic) assessment (if not included within the Deign report); • Chemical Compatibility Report (with respect to PETROBRAS injected fluid data informed within ref. [2]), and alerts to other harmful fluids and concentrations, listed or not listed in Erro! Fonte de referência não encontrada., based on SUPPLIER experience; • Manufacturing Procedure Specification (MPS) to be submitted to PETROBRAS for review prior to start of design and production work, as a minimum, includes the following: <ul style="list-style-type: none"> ○ Procedures including process control plans; ○ Testing and Inspection Plan with monitoring points identified; ○ Factory acceptance testing. 			

	TECHNICAL SPECIFICATION	Nº I-ET-0000.00-0000-290-P9U-005	REV. 0
	JOB:	GENERAL	
	TITLE:	TITANIUM PULL IN TUBE SPECIFICATION	
		SHEET 39 of 43	
		SUB/ES/EDD/EDR	

- Inspection and maintenance manual, as pe section 13.3;
- General assembly drawings of TIPT and mock up drawings, as per section 13.4;
- Inspection and test reports, records, and procedures as defined by this Specification;
- As-built drawings or as-built dimensional reports;
- Solid numeric model of the designed Adapter Bushing, the Steel Bushing and the portion of the TIPT Head within it, in a file format to be agreed.

The QA/QC, DBM and MPS shall be written specifically for the PURCHASE ORDER and shall be approved by PETROBRAS prior to commencement of manufacturing operations.

SUPPLIER shall notify PETROBRAS of any changes in these practices for PETROBRAS review/approval prior to implementation.

Design calculations and reports of the Stress Joint shall be issued to PETROBRAS for review prior to the manufacturing.

Nonconformity reports shall be issued to PETROBRAS within the contractual deadline.

All non-conformity reports, including concession requests, shall be submitted to PETROBRAS for review.

13.3. INSPECTION AND MAINTENANCE MANUAL

SUPPLIER shall present an inspection and maintenance manual for the Titanium Stress Joints.

This manual shall present any inspection necessary to avoid the Stress Joint failure during the whole specified project operational life.

Include a Repair Procedure of the external rubber cover.

All necessary tools, inspection methodology, acceptance criteria and inspection interval shall be present in this manual, for each necessary inspection.



A list of possible harmful fluids and operational limits (temperature, potential of the CP, etc.) shall be included as an alert.

13.4. DRAWINGS

HOLD

13.5. PROJECT MANAGEMENT

- QHSE/PEP Plans - SUPPLIER shall submit a detailed HSE Plan within two weeks of Purchase Order award and shall submit a detailed Project Execution Plan (PEP) within four weeks of Purchase Order award, for PETROBRAS approval. SUPPLIER's PEP shall be designed to achieve all deliveries in line with PETROBRAS's requirements. SUPPLIER shall

	TECHNICAL SPECIFICATION	Nº I-ET-0000.00-0000-290-P9U-005	REV. 0
	JOB: GENERAL	SHEET 40 of 43	
	TITLE: TITANIUM PULL IN TUBE SPECIFICATION	 SUB/ES/EDD/EDR	

also submit a Manufacturing Quality Plan detailing all procurement, manufacturing, and inspection processes and activities for PETROBRAS approval within the contractual deadlines.

- Status Report – In case of PETROBRAS direct purchase of TIPT, SUPPLIER shall submit a full status report at least monthly. Additional brief updates at more frequent intervals may be required as needed during design, fabrication, and testing of Stress Joint components.
- Organization and Key Personnel - SUPPLIER shall assign key engineering and service personnel to manage and control the Work from start through to final delivery. Such personnel shall not be changed without PETROBRAS notification. Within 02 weeks of receipt of Purchase Order, SUPPLIER shall submit an organization chart defining the reporting structure and shall provide resumes of the proposed key candidates, with others on request, for PETROBRAS approval.
- SUPPLIER shall confirm compliance with all the requirements of this document, and the referenced documents during the review of the manufacturing quality plan. Any deviation from the requirements of this document shall be highlighted and forwarded to PETROBRAS for review and approval. In the event of any disparity of information given in this document with any referenced document or standard, written clarification shall be sought from PETROBRAS before proceeding with design and/or fabrication of the Stress Joints.
- Stress Joint delivery and shipping schedule shall be mutually agreed prior to award of contract.

13.6. TRACEABILITY AND MARKING



13.6.1. RAW MATERIAL

Traceability of components shall be established during fabrication, verified at receiving inspection, and shall be fully documented throughout the entire manufacturing process.

The forger shall have an established material traceability plan. Each forging shall be given a unique serial number. The serial number shall be traceable to the heat number and heat treat batch number. Full traceability shall be maintained with respect to the following, as applicable: Heat, Ingot, Heat-Treat Sequence or lot.

13.6.2. PRODUCT MARKING

The Stress Joint must be stamped for permanent identification, including identifying features such as size, rating, and SUPPLIER's assigned serial number. Additional marking for riser tagging may be required by PETROBRAS, wherefore SUPPLIER shall seek PETROBRAS concordance with the product marking.

	TECHNICAL SPECIFICATION	Nº I-ET-0000.00-0000-290-P9U-005	REV. 0
	JOB:	GENERAL	
	TITLE:	TITANIUM PULL IN TUBE SPECIFICATION	
		SHEET 41 of 43	
		SUB/ES/EDD/EDR	

NOTE: SUPPLIER may use an individual mark (P/N or S/N) for each fabricated item. This mark, transferred on the associated documentation, allows guaranteeing the traceability.

13.6.3. MANUFACTURING OPERATOR AND INSPECTOR MARKING

On all kind of document (manufacturing or test router, report or ITP), the person who will handle the task shall affix his own mark and signature.

13.7. HANDLING, STORAGE AND SHIPPING

Storage and handling procedures shall provide for techniques and protections to avoid mechanical and weather damage. Lifting and support of the TIPT shall be done in a manner that avoids concentrated loads or single point lifts. Schematic drawing of the support points, lifting points and transport crate shall be included within the handling, storage and shipping procedure.

TIPT systems shall be shipped via steel shipping skids or fully boxed steel beam truss baskets for offshore shipment. Wire rope lifting slings and pad eyes shall be designed per [28]. Pad eyes are to be pull tested to 1.5 times the safe working load (SWL). For multi-pad eye structures, 2 pad eyes are to be tested simultaneously to ensure that the primary load path structure is tested. For this case, the total test load shall be 2 times the 1.5 times the SWL. Loading shall be in the vertical direction, +/- 5 degrees, with a hold time of 3 minutes.

The Stress Joint skid shall be clearly marked by paint stencil to identify the contents by size, serial number, CoG and lifting points. The Stress Joint shall be protected against moisture/corrosion or any foreseeable industrial atmosphere degradation of the rubber cover, if it may be stored in an open air, unprotected area.

13.8. DOCUMENTATION REQUIREMENTS (DATA BOOK)



Copy of a final report for each manufactured TIPT shall be submitted to PETROBRAS for review and approval prior to final acceptance. This report shall contain Purchase Order number, part number, dash number, serial number, actual weight, all material certifications, dimensional verification, test results and on-site verification of current visual examination compliance by site inspectors and surveyors, and shall certify that the product was manufactured and inspected in accordance with the requirements of applicable drawing(s) and this Specification.

Additional documentation shall be submitted in accordance with [2].

SUPPLIER shall submit a detailed description of the manufacturing process.

SUPPLIER shall document the design with drawings and calculations.

All tests and clarifications required for the design acceptance and the evaluation of the Flexible Joint and receptacle shall be submitted.

	TECHNICAL SPECIFICATION	Nº I-ET-0000.00-0000-290-P9U-005	REV. 0
	JOB:	GENERAL	
	TITLE:	TITANIUM PULL IN TUBE SPECIFICATION	
		SHEET 42 of 43	
		SUB/ES/EDD/EDR	

SUPPLIER shall submit the quality control procedures for PETROBRAS review and approval.

SUPPLIER shall submit document stating all deviations to this Specification.

13.9. INSPECTION AND TEST PLAN

This section concerns the product fabricated by SUPPLIER as well as the product purchased by SUPPLIER.

At the beginning of the Project, within the contractual deadlines, the Inspection and Test Plans (ITP) for all established items shall be issued for PETROBRAS comments. SUPPLIER shall obtain with PETROBRAS all self-assigned Inspection points (mainly Hold and Witness points) before the start of the manufactures.

All testing procedures are subject to both internal (SUPPLIER) and external (PETROBRAS or PETROBRAS's representative) Quality Control oversight and verification. PETROBRAS approved procedures shall be issued with reasonable advance before the start of manufacture.

The same document shall be used by the SUPPLIER and its SUB-SUPPLIER.

The following ITP shall be produced:

- Forgings and material testing ITPs;
- Machining ITP(s);
- Weld and Heat treatment ITPs (if permitted);
- NDE ITP
- Coating/ painting ITP;
- Cladding ITP(s) (inner surface cladding and sealing surfaces);
- Stress Joint and Pup Piece ITP (assembly, final painting, FAT and other tests, etc.).

The ITP sums up the inspection points, applied by:

- SUB-SUPPLIER;
- SUPPLIER;
- PETROBRAS and CONTRACTOR;
- 3rd Party Inspection.

The ITP shall be submitted for PETROBRAS review. All PETROBRAS holding and witnessing points shall be confirmed prior to start of manufacturing.

The inspection points are defined hereafter:



Table 13.1 – Inspections Points and Definitions

Inspection Level	Definition
H: Hold Point	A point at which work cannot progress beyond, until the activity has been witnessed or written approval has been given by the parties who have designated the hold point.
W: Witness Point	A point where the opportunity to witness shall be given to the parties who have designated the witness.
W1: Foak	A Witness Point limited to the First of a Kind event.
M: Monitor Point	Activity surveillance on a random basis to verify compliance with contract specifications and procedures.
R: Review Point	Evaluation of Project generated documentation.

Contractual aspects of the inspections (including notification for inspection issuing deadline and notification date revision) shall adhere to the Contractual Guidance for Quality Management, as per [1].