	TECHNICAL SPECIFICATION		Nº. I-ET-3010.1M-1200-200-P4X-001
	CLIENT:	SRGE	SHEET: 1 of 15
	JOB:	REFERENCE BASIC DESIGN	1001056398 0010
	AREA:	BÚZIOS	
DP&T-SRGE	TITLE:	PIPING SPECIFICATION FOR TOPSIDE	NP-1 ESUP

MICROSOFT WORD / V.2016 / I-ET-3010.1M-1200-200-P4X-001_F.DOCX

INDEX OF REVISIONS

REV.	DESCRIPTION AND/OR REVISED SHEETS
0	ORIGINAL ISSUE
A	GENERAL REVISION
B	GENERAL REVISION
C	B19 max temperature corrected to 210°C and BG service included in B3
D	REVISED TO NPS 4 THE MINIMUM SIZE OF COMPACT FLANGE IN SPECS CLASS 2500
E	TABLE A.7, ITEM 6 AND ITEM 8 - REVISED ACCORDING CLARIFICATION NOTICE DUE TO BIDDERS QUESTIONS
F	REVISED ACCORDING CLARIFICATION NOTICE DUE TO BIDDERS QUESTIONS: <ul style="list-style-type: none"> Notes 29(duplex specs), 48(superduplex specs) and 51(SS specs). Standard for swage nipple in SS specs; standard information for SO flanges in CuNi specs; standard information for FRP flanges in FRP specs and standard information for API 6A flanges in J12, J12P, J40 e J40P. Note 42 was inserted in B30. Standard in VDS: VES-150-1-U600, VRE-150-1-U655, VES-150-1-U300, VES-150-2-U300, VRE-150-1-D305, VRE-150-1-U305. Annex A : table A.29 and A.44; items A.1, A.7.3.1(a), A.8.2.3.1.6 and A.9.3.5.8. Correction in reference documents: A.6.2.1.3; B.5.2.3; B.5.2.4; B.6.2.2; B.6.2.3; B.8.2.1; B.8.2.2; B.9.2.2; D.5.1; E.4; Note 57; Note 67 and Table C.1.

	REV. 0	REV. A	REV. B	REV. C	REV. D	REV. E	REV. F	REV. G	REV. H
DATE	APR/04/19	JUN/06/20	JUL/07/20	JUL/22/20	JUL/27/20	SEP/02/20	SEP/23/20		
DESIGN	ESUP	ESUP	ESUP	ESUP	ESUP	ESUP	ESUP		
EXECUTION	ESTEVEES	ESTEVEES	ESTEVEES	ESTEVEES	ESTEVEES	CJW2	CJW2		
CHECK	PONTE	PONTE	PONTE	PONTE	PONTE	HR7W	HR7W		
APPROVAL	TMCAMPOS	TMCAMPOS	TMCAMPOS	TMCAMPOS	TMCAMPOS	U32N	U32N		

INFORMATION IN THIS DOCUMENT IS PROPERTY OF PETROBRAS, BEING PROHIBITED OUTSIDE OF THEIR PURPOSE.

FORM OWNED TO PETROBRAS N-0381 REV.L.



PETROBRAS

TECHNICAL SPECIFICATION

Nº. I-ET-3010.1M-1200-200-P4X-001

REV: F

AREA: BÚZIOS

SHEET: 2 of 15

TITLE: **PIPING SPECIFICATION FOR TOPSIDE**

NP-1

ESUP

SUMMARY

1	SCOPE	3
2	NORMATIVE REFERENCES	3
3	SYMBOLS AND ABBREVIATED TERMS	6
4	PIPING TAGGING SYSTEM	9
5	PIPING SPECIFICATIONS X SERVICES	10
6	PIPING SPECIFICATIONS.....	12
7	PIPING SPECIFICATION CODE RULE	14
8	PIPING MATERIAL SPECIFICATIONS	15

ANNEX

- A. Valves and Valve Datasheets**
- B. Pipes, Fittings and Accessories and Datasheets**
- C. Typical Arrangement for Drain&Vent and Instruments**
- D. Piping Material Selection for Corrosive HC and Produced Water**
- E. Flange Isolation Kit**
- F. Requirements for Piping internal Coating (cancelled)**
- G. Welding Requirements**
- H. Requirements for FRP Pipes and Fittings**
- J. Piping Weld Inspection (cancelled)**
- K. Pressure Safety Valves**

1 SCOPE

This Guideline standardizes piping and valves materials for use in oil and gas exploration and production facilities.

This document specifies requirements for acquisition of: pipes, valves, fittings, flanges, gaskets bolts and nuts. Aspects of design, performance, materials, fabrication, testing, inspection, marking, storage, expedition and documentation are covered.

The designer is responsible for selecting the piping material specification (spec) taking into account its limitations, such as: service, pressure and temperature.

2 NORMATIVE REFERENCES

Note: The Standards referred herein shall be considered in their latest edition/revision.

API RP 14E	Recommended Practice for Design and Installation of offshore Production Platform Piping Systems.
API SPEC 5L	Specification for Line Pipe.
API 6A	Specification for Wellhead and Christmas Tree Equipment
API SPEC 6D	Petroleum and Natural Gas Industries – Pipeline Transportation Systems - Pipeline Valves.
API STD 594	Check Valves: Wafer, Wafer - Lug, and Double Flanged Type.
API STD 598	Valve Inspection and Testing
API STD 599	Metal Plug Valves - Flanged, Threaded and Welding Ends
API STD 600	Bolted Bonnet Steel Gate Valves for Petroleum and Natural Gas Industries.
API STD 602	ISO 15671 – Compact Steel Gate Valves – Flanged, Threaded, Welding, and Extended – Body Ends.
API STD 607	Fire Test for Quarter turn Valves and Valves Equipped with Nonmetallic Seats
API STD 609	Butterfly Valves: Double Flanged, Lug and Wafer – Type.
ASME B1.1	Unified Inch Screw Threads (UN and UNR Thread Form).
ASME B1.20.1	Pipe Threads, General Purpose (Inch).
ASME B16.1	Cast Iron Pipe Flanges and Flanged Fittings Classes 25, 125 and 250.
ASME B16.5	Pipe flanges and flanged fittings NPS 1/2 through NPS 24 metric/inch standard revision e ASME B16.5
ASME B16.9	Factory-made wrought steel butt welding fittings.
ASME B16.10	Face-to-face and end-to-end to valves
ASME B16.11	Forged Fittings, Socket-Welding and Threaded.
ASME B16.20	Metallic gaskets for pipe flanges ring-joint, spiral-wound, and jacketed.
ASME B16.21	Nonmetallic Flat Gaskets for Pipe Flanges.
ASME B16.25	Butt welding Ends.
ASME B16.28	Wrought Steel Butt welding Short Radius Elbows and Returns.
ASME B16.34	Valves – Flanged, threaded and welding end
ASME B16.47	Large diameter Steel Flanges (NPS 26 through NPS 60).
ASME B16.5	Pipe Flanges and Flanged Fittings: NPS 1/2 through NPS 24 Metric/Inch Standard
ASME B18.2.2	Square and Hex Nuts (Inch Series).
ASME B31.3	Process Piping.
ASME B31.4	Pipeline Transportation Systems for Liquid Hydrocarbons and Other Liquids

**TECHNICAL SPECIFICATION**

Nº. I-ET-3010.1M-1200-200-P4X-001

REV: F

AREA: BÚZIOS

SHEET: 4 of 15

TITLE: **PIPING SPECIFICATION FOR TOPSIDE**

NP-1

ESUP

ASME B31.8	Gas Transmission and Distribution Piping Systems
ASME B36.10	Welded and Seamless Wrought Steel Pipe.
ASME B36.19	Stainless Steel Pipe
ASTM A105	Standard Specification for Aço carbonoForgings for Piping Applications.
ASTM A106	Standard Specification for Seamless Aço carbonoPipe for High Temperature Service.
ASTM A123	Standard Specification for Zinc (Hot-Dip Galvanized) Coatings on Iron and Steel Products.
ASTM A126	Standard Specification for Gray Iron Castings for Valves, Flanges, and Pipe Fittings.
ASTM A182	Standard Specification for Forged or Rolled Alloy Steel Pipe Flanges, Forged Fittings, and Valves and Parts for High Temperature Service.
ASTM A193	Standard Specification for Alloy Steel and Stainless Steel Bolting Materials for High Temperature Service.
ASTM A194	Standard specification for carbon and alloy steel nuts for bolts for high pressure or high temperature service, or both.
ASTM A216	Standard Specification for Steel Castings, Carbon, Suitable for Fusion Welding, High Temperature Service.
ASTM A234	Standard Specification for Piping Fittings of Wrought Aço carbonoand Alloy Steel for Moderate and High Temperature Service.
ASTM A269	Standard Specification for Seamless and Welded Austenitic Stainless Steel Tubing for General Service
ASTM A312	Standard Specification for Seamless, Welded, and Heavily Cold Worked Austenitic Stainless Steel Pipes.
ASTM A320	Standard Specification for Alloy Steel and Stainless Steel Bolting Materials Low High Temperature Service.
ASTM A333	Standard Specification for Seamless and Welded Steel Pipe for Low Temperature Service.
ASTM A350	Standard Specification for Carbon and Low Alloy Steel Forgings, Requiring Notch Toughness Testing for Piping Components.
ASTM A351	Standard Specification for Castings, Austenitic, Austenitic Ferritic (Duplex), for Pressure Containing Parts.
ASTM A352	Standard Specification for Steel Castings, Ferritic and Martensitic, for Pressure Containing Parts, Suitable for Low Temperature Service.
ASTM A358	Standard Specification for Electric Fusion Welded Austenitic Chromium Nickel Stainless Steel Pipe for High Temperature Service and General Applications
ASTM A403	Standard Specification for Wrought Austenitic Stainless Steel Piping Fittings.
ASTM A420	Standard Specification for Piping Fittings of Wrought Aço carbonoand Alloy Steel for Low Temperature Service.
ASTM A487	Standard Specification for Steel Castings Suitable for Pressure Service.
ASTM A522	Standard Specification for Forged or Rolled 8 and 9% Nickel Alloy Steel Flanges, Fittings, Valves, and Parts for Low Temperature Service
ASTM A536	Standard Specification for Ductile Iron Castings.
ASTM A564	Standard Specification for Hot Rolled and Cold Finished Age Hardening Stainless Steel Bars and Shapes.
ASTM A671	Standard Specification for Eletric Fusion Welded Steel Pipe for Atmospheric and Lower Temperatures.
ASTM A694	Standard Specification for Carbon and Alloy Steel Forgings for Pipe Flanges, Fittings, Valves, and Parts for High Pressure Transmission Service.
ASTM A733	Standard Specification for Welded and Seamless Carbon Steel and Austenitic Stainless Steel Pipe Nipples



TECHNICAL SPECIFICATION	Nº:	I-ET-3010.1M-1200-200-P4X-001	REV:	F	
	AREA:	BÚZIOS		SHEET:	5 of 15
	TITLE:	PIPING SPECIFICATION FOR TOPSIDE		NP-1	
				ESUP	

ASTM A790	Standard Specification for Seamless and Welded Ferritic/Austenitic Stainless Steel Pipe.
ASTM A815	Standard Specification for Wrought Ferritic, Ferritic/Austenitic, and Martensitic Stainless Steel Piping Fittings.
ASTM A928	Standard Specification for Ferritic/Austenitic (Duplex) Stainless Steel Pipe Electric Fusion Welded with Addition of Filler Metal
ASTM A995	Standard Specification for Castings, Austenitic Ferritic (Duplex) Stainless Steel, for Pressure Containing Parts
ASTM B62	Standard Specification for Composition Bronze or Ounce Metal Castings.
ASTM B366	Standard Specification for Factory Made Wrought Nickel and Nickel Alloy Fittings
ASTM B444	Specification for Nickel Chromium Molybdenum Columbium Alloys (UNS N06625 and UNS N06852) and Nickel Chromium Molybdenum Silicon Alloy (UNS N06219) Pipe and Tube
ASTM B564	Specification for Nickel Alloy Forgings
ASTM B584	Standard Specification for Copper Alloy Sand Castings for General Applications.
ASTM D1784	Standard Specification for Rigid Poly (Vinyl Chloride) (PVC) Compounds and Chlorinated Poly (Vinyl Chloride) (CPVC) Compounds.
ASTM D1785	Standard Specification for Poly (Vinyl Chloride) (PVC) Plastic Pipe, Schedules 40, 80 and 120.
ASTM D2467	Standard Specification for Poly (Vinyl Chloride) (PVC) Plastic Pipe Fittings, Schedule 80.
ASTM D3567	Standard Practice for Determining Dimensions of Fiberglass (Glass-Fiber Reinforced Thermosetting Resin) Pipe and Fittings R (2002).
ASTM D4024	Standard Specification for Machine Made "Fiberglass" (Glass-Fiber Reinforced Thermosetting Resin) Flanges (2000).
ASTM F1173	Standard Specification for Thermosetting Resin Fiberglass Pipe Systems to be used for Marine Applications (2001).
ASTM F1387	Standard Specification for Performance of Piping and Tubing Mechanically Attached Fittings
ASTM F439	Standard Specification for Chlorinated Poly (Vinyl Chloride) (CPVC) Plastic Pipe Fittings, Schedule 80.
BSI BS 1873	Stell Globe and Globe Stop and Check Valves (flanged and butt welding ends) for the Petroleum, Petrochemical and Allied Industries.
BSI BS 3799	Steel Pipe Fittings, Screwed and Socket Welding for the Petroleum Industry.
BSI BS 5152	Cast Iron Globe and Globe Stop and Check Valves for General Purposes.
BSI BS 5351	Steel Ball Valves for the Petroleum, Petrochemical and Allied Industries.
BSI BS 5352	Steel Wedge Gate, Globe and Check Valves 50 mm and Smaller for the Petroleum, Petrochemical and Allied Industries.
EEMUA 144	90/10 Copper Nickel Alloy Piping for Offshore Applications. Tubes Seamless and Welded.
EEMUA 145	90/10 Copper Nickel Alloy Piping for Offshore Applications. Flanges Composite and Solid.
EEMUA 146	90/10 Copper Nickel Alloy Piping for Offshore Applications. Fittings.
IMO A 753(18)	International Maritime Organization Resolution A 753(18).
ISO 15156	Petroleum and natural gas industries: Materials for use in H ₂ S containing environments in oil and gas production.
ISO 14692	Petroleum and natural gas industries: Glass reinforced plastic (GRP) piping.
ISO 17292	Metal ball valves for petroleum, petrochemical and allied industries.

ISO 21457	Petroleum, petrochemical and natural gas industries – Material selection and corrosion control for oil and gas production systems.
ISO 27509	Petroleum and natural gas industries: Compact Flanged connections with IX seal ring (First Edition).
MSS SP 6	Standard Finishes for Contact Faces de Pipe Flanges and Connecting End Flanges of Valves and Fittings.
MSS SP70	Cast Iron Gate Valves, Flanged and Threaded Ends.
MSS SP 71	Gray Iron Swing Check Valves, Flanged and Threaded Ends.
MSS SP 72	Ball Valves with Flanged or Butt Welding Ends for General Service.
MSS SP 75	Strength, Wrought, Butt Welding Fittings.
MSS SP 80	Bronze Gate, Globe, Angle and Check Valves.
MSS SP 83	Steel Pipe Unions, Socket Welding and Threaded.
MSS SP 88	Diaphragm Type Valves.
MSS SP 95	Swage (d) Nipples and Bull Plugs.
MSS SP 97	Integrally Reinforced Forged Branch Outlet Fittings – Socket Welding, Threaded, and Buttwelding Ends.
NBR 15827	Industrial Valves for Installations of Exploration, Production, Refining and Transport of Petroleum Products - Requirements for Design and Prototype Test.
NORSOK M-001	Materials Selection

3 SYMBOLS AND ABBREVIATED TERMS

For the purposes of this document, the following symbols and abbreviated terms apply:

AISI	American Iron and Steel Institute
API	American Petroleum Institute
ASME	American Society of Mechanical Engineering
ASTM	American Society For Testing And Materials
BE	Beveled Ends
BF	Butt Strap
BLE	Beveled Large Ends.
BS	Bell Spigot
CL	Class
CPVC	Chlorinated Polyvinyl Chloride
Cr	Chrome
CS	Carbon Steel
CuNi	Copper-Nickel
DSS	Duplex Stainless Steel
EEMUA	Engineering Equipment and Materials Users Association
EJ	Elastic Joint
FLG	Flange
FF	Flat Face
FRP	Fiber reinforced plastic
FCAP	Capilar Union Female
FTHD	Threaded Female
GALV	Galvanized
GR	Grade
GRP	Glass Fiber Reinforced Plastic
HC	Half Coupling
HEX	Hexagonal



PETROBRAS

TECHNICAL SPECIFICATION

Nº. I-ET-3010.1M-1200-200-P4X-001

REV: F

AREA: BÚZIOS

SHEET: 7 of 15

TITLE: **PIPING SPECIFICATION FOR TOPSIDE**

NP-1

ESUP

IMO	International Maritime Association
IN	Inch
LTCS	Low Temperature Carbon Steel
MAX	Maximum
MCap	Capilar Union Male
MSS	Manufacturers Standardization Society of the Valve and Fittings Industry
MTHD	Threaded Male
NACE	National Association of Corrosion Engineers
NPT	National Pipe Thread (Thread ASME B1.20.1)
NSFHT	National Standard Fire Hose Thread (Thread)
Org coat	Organic Coated
PBE	Plain Both Ends
PE	Plain Ends
PSE	Plain Short Ends.
PSI	Pounds per square inch
PTFE	Polytetrafluoroethylene
PVC	Polyvinyl Chloride
RF	Raised Face
RJ	Rigid Joint
RTEE	Reduction Tee
RTJ	Ring Type Joint
SCH	Schedule
SDL	Saddle
SDSS	Super duplex Stainless Steel
SDV	Shut Down Valve
SML	Seamless
SOC	Socketlet
SPEC	Piping Material Specification
SS	Stainless Steel
STD	Standard
SW	Socket Weld
TBE	Threaded Both Ends
TEE	Tee
THD	Threaded
UNS	Unified Numbering System
VAG	Needle Valve
VAGI	Instrumentation Needle Valve
VAX	Axial Valve
VBO	Butterfly Valve
VDE	Double Ball valve
VDI	Diaphragm Valve
VES	Ball Valve
VESI	Instrumentation Ball Valve
VGA	Gate Valve
VGL	Globe Valve
VMA	Plug valve
VPVC	Plastic valve
VRE	Check Valve
WOL	Weldolet
XS	Extra Strong
XXS	Double Extra Strong
WLD	Welded
WN	Weld Neck



PETROBRAS

TECHNICAL SPECIFICATION

Nº. I-ET-3010.1M-1200-200-P4X-001

REV: F

AREA: BÚZIOS

SHEET: 8 of 15

TITLE: **PIPING SPECIFICATION FOR TOPSIDE**

NP-1

ESUP

WOL Weldolet
WPS Welding Procedure Specification
WPQR Welding Procedure Qualification Record

4 PIPING TAGGING SYSTEM

4.1. GENERAL

A-B-C-D-E

A – Nominal Pipe Size

Non-Integer Nominal Pipe Sizes shall be written as Fractions using a dash (“-”) to separate the integer part from the fraction, if necessary. Example: 1/2, 3/4, 1-1/2, 2-1/2.

The number/fraction shall be followed by the double prime symbol (”) representative of inch unit, never two (‘) prime symbols.

B – Service Symbols (as listed in Item 5)

C – Piping Material Specification Code

D – Sequential Numbering of Line

Shall consist of sequential number containing exactly 4 digits.

E – Insulation:

PP – Personal Protection

HC – Heat Conservation

CC – Cold Conservation

NI – Not Insulated (Absence of insulation shall always be represented by “NI”)

Note: Piperun tag shall not contain any spaces between caracteres

4.2. EXAMPLE OF PIPING TAG

1-1/2”-P-B10-0010-HC

Nominal Pipe Size: 1 1/2 inch

Service: P - Process

Piping Material Specification: B10

Sequential Numbering: 0010

Insulation: Heat Conservation

4.3. PIPELINE TAGGING FOR 3D MODELLING

B-D

For 3D modelling, where Pipeline tagging is also required, it shall consist only of Service and sequential. Additional information regarding nominal pipe size, specification and insulation shall be associated with the piperun. Example of pipeline tag:

P-0010

Service: Process (non-corrosive Hydrocarbon)

Sequential Numbering: 0010



PETROBRAS

TECHNICAL SPECIFICATION

Nº. I-ET-3010.1M-1200-200-P4X-001

REV: F

AREA: BÚZIOS

SHEET: 10 of 15

TITLE: **PIPING SPECIFICATION FOR TOPSIDE**

NP-1

ESUP

5 PIPING SPECIFICATIONS X SERVICES

Code	Service	Specs
ADW	Aerated Dilution Water	B11, B23
AM	Amine	B10, B16, B3, B9, C10, C16, E10, E16, E3
BG	Inert Gas	B3, B10, C10, E10, F10, G10, R3B, R3C, R9B, R9C, S3B, S3C, S9B, S9C
CHW	Chilled Water	B1, B10, B20, R9B, R9C, S9B, S9C
CI	Chemical Injection (non-corrosive)	B1, B10, C10, E10, F10, G10, S9B, S9C, T12, T3,
CI2	DBNPA Biocide	B27
CN	Sodium Hypochlorite	B14, B20, B27
CNI	Corrosive Chemical Injection (Except Sodium Hypochlorite)	B3, C3, E3, F3, G3, H16, H3, J12, S3B, S3C, T12, T3,
D	Diesel	B10, B3, C10, C3, H10
DA	Open Drain	B22, B23, B25, B9, R9B, R9C, S9B, S9C
DF	Closed Drain (Non-Corrosive hydrocarbon)	B1, B10
DFC	Closed Drain (Corrosive Hydrocarbon)	B9, G16
DO	Carbon Dioxide (DRY)	C8, E8
DOH	Carbon Dioxide w/ Hydrocarbon	J12P, J31, J31P
DW	Distilled Water	B3, R3B, R3C, S3B, S3C
F	Safety System and Flare	B10, B12, B16, B19, B3, B30, B50, B6, B9, C3, C6
FG	Fuel Gas	B10, B19, B3, B6, C10, C3, E10, E3, E6, F10, F3, G3
FL	Foam Line	B1, B10, B7, B7R
FLC	Concentrated Foam	B3
FP	Production and Drilling Fluid	B5, C5, E5, F5, G5, H5
FW	Fire Water (Sea Water)	B24, B7, B7R, S7
G	Glycol	B10, B3, B6, C10, C3, C6, E10, E3, E6, F10, F3, G10, G3, G6, H6
GL	Refrigerated Liquefied Petroleum Gases in Low Temperature	B6, C6, E6, F6, G6
H	Hydraulic Fluid	B3, C3, E3, F3, G3, H3, S3B, S3C
HF	Hot Fluid	B4, C4
HWP	Process Heating Water	B4, C4, E4
HWU	Utility Heating Water	B21, B22, B23, B4



PETROBRAS

TECHNICAL SPECIFICATION

Nº. I-ET-3010.1M-1200-200-P4X-001

REV: F

AREA: BÚZIOS

SHEET: 11 of 15

TITLE: **PIPING SPECIFICATION FOR TOPSIDE**

NP-1

ESUP

Code	Service	Specs
IA	Instrumentation Air	B3, G3, R3B, R3C, S3B, S3C
IG	Instrumentation Gas	B3
IGN	Ignition Line	B3
IN	Instrumentation Nitrogen	B3, R3B, R3C, S3B, S3C
IW	De-Aerated Sea Water Injection	B1, B10, B14, B23, C10, C14, C30, E10, E14, F10, F14, G10, G14, H12, H30
IWC	Aerated Sea Water Injection	B14, B22, B23
JF	Helicopter Refueling	B3
OL	Lubricating Oil	B10, R9B, R9C, S9B, S9C
P	Process (non-corrosive hydrocarbon)	B10, B6, C10, C10P, C6, E10, E3, E6, F10, F10P, F3, F6, G10, G10P, G3, G6, H10, H10P, H10R, H12, H12P, H3, H31, H6, J10, J12, J12P, J31, J31P, J40, J40P
PC	Process (Corrosive Hydrocarbon)	B11, B12, B16, B17, B19, B3, B30, B9, C12, C16, C19, C3, C30, C9, E16, E17, E19, E3, E30, E32, E9, F16, F3, F30, F32, G12, G12P, G16, G16P, G19, G3, H12, H12P, H16, H3, H30, H30P, H31, H33, J12, J12P, J40, J40P
PCW	Produced water	B11, B12, B25, B26, C11, C12, C30, E11, F11, G11, H11
PW	Potable Water	B20, B3, R3B, R3C, S3B, S3C
PWH	Hot Fresh Water	B21, B22, B23, B3, S3B, S3C
S	Steam	B4, C4, E4, F4, G4, S9B, S9C
SA	Service Air	B1, B10, C10, R9B, R9C, S9B, S9C
SC	Steam Condensate	B4, C4, E4, F4, G4, S9B, S9C
SFW	Fire Water (Fresh Water)	A4
SN	Start-up Nitrogen	B1, B10, C10, R9B, R9C, S9B, S9C
STA	Start-up Air	C10H
SW	Sea water	B14, B22, B23, B7R, C14, C23
W	Industrial water	B1, B10, B20, B22, B23, B3, C10, E10, F10, G10, H10, R9B, R9C, S9B, S9C



PETROBRAS

TECHNICAL SPECIFICATION

Nº. I-ET-3010.1M-1200-200-P4X-001

REV: F

AREA: BÚZIOS

SHEET: 12 of 15

TITLE: **PIPING SPECIFICATION FOR TOPSIDE**

NP-1

ESUP

6 PIPING SPECIFICATIONS

SPEC	PRESSURE CLASS	CORROSION ALLOWANCE (mm)	MIN TEMP (°C)	MAX TEMP (°C)	PIPE MATERIAL	SERVICE CODE
B10	150	1.6 mm	-29	200	Carbon Steel	AM BG CHW CI D DF F FG FL G IW OL P SA SN W
B11	150	-	0	150	Organic Coat CS	ADW PC PCW
B12	150	-	0	140	Super Duplex	F PC PCW
B14	150	-	0	70	Organic Coat CS	CN IW IWC SW
B16	150	-	-46	130	Duplex	AM F PC
B19	150	3.2 mm	-46	210	Low Temp CS	F FG PC
B20	-	-	23	40	PVC	CHW CN PW W
B21	-	-	27	80	CPVC	HWU PWH
B22	10 bar	-	90	90	FRP	DA HWU IWC PWH SW W
B23	16 bar	-	90	90	FRP	ADW DA HWU IW IWC PWH SW W
B27	16 bar	-	85	85	FRP	CI2 CN
B3	150	-	-100	260	SS 316/316L	AM BG CNI D DW F FG FLC G H IA IG IGN IN JF PC PW PWH W
B30	150	-	0	240	CS Inconel Clad.	F PC
B4	150	1.6 mm	0	300	Carbon Steel	HF HWP HWU S SC
B50	150	-	38	538	SS 310H	F
B6	150	1.6 mm	-46	240	Low Temp CS	F FG G GL P
B7	20 bar	-	0	75	Copper-Nickel	FL FW
B9	150	3.2 mm	-29	240	Carbon Steel	AM DA DFC F PC
C10	300	1.6 mm	0	240	Carbon Steel	AM BG CI D FG G IW P SA SN W
C11	300	-	0	120	Organic Coat CS	PCW
C12	300	-	0	140	Super Duplex	PC PCW
C19	300	3.2 mm	-46	200	Low Temp CS	PC
C23	25 bar	-	90	90	FRP	SW
C3	300	-	-100	150	SS 316/316L	CNI D F FG G H PC
C30	300	-	-20	200	CS Inconel Clad.	IW PC PCW
C4	300	1.6 mm	0	350	Carbon Steel	HF HWP S SC
C6	300	1.6 mm	-46	110	Low Temp CS	F G GL P
C8	300	-	-18	54	Galv. CS	DO
C9	300	3.2 mm	0	240	Carbon Steel	PC
E10	600	1.6 mm	-20	210	Carbon Steel	AM BG CI FG G IW P W
E16	600	-	-46	130	Duplex	AM PC
E19	600	3.2 mm	-46	180	Low Temp CS	PC

SPEC	PRESSURE CLASS	CORROSION ALLOWANCE (mm)	MIN TEMP (°C)	MAX TEMP (°C)	PIPE MATERIAL	SERVICE CODE
E3	600	-	-100	200	SS 316/316L	AM CNI D FG G H P PC
E30	600	-	-20	200	CS Inconel Clad.	PC
E32	600	-	-55	330	3.5Ni InconelClad	PC
E6	600	1.6 mm	-46	180	Low Temp CS	FG G GL P
E8	600	-	-18	54	Galv. CS	DO
E9	600	3.2 mm	0	150	Carbon Steel	PC
F3	900	-	-100	200	SS 316/316L	CNI D FG G H P PC
F6	900	1.6 mm	-46	320	Low Temp CS	GL P
G3	1500	-	-100	210	SS 316/316L	CNI D FG G H IA P PC
H10	2500	1.6 mm	-20	175	Carbon Steel	D P W
H12	2500	-	-50	115	Super Duplex	IW P PC
H12P	2500	-	-50	115	Super Duplex	P PC
H16	2500	-	-50	130	Duplex	CNI PC
H3	2500	-	-100	150	SS 316/316L	CNI H P PC
H30	2500	-	-20	115	CS Inconel Clad.	IW PC
H30P	2500	-	-20	115	CS Inconel Clad.	PC
H6	2500	1.6 mm	-46	180	Low Temp CS	G P
J12	10000	-	-50	100	Super Duplex	CNI P PC
J12P	10000	-	-50	100	Super Duplex	DOH P PC
J40	10000	-	-100	155	Inconel	P PC
J40P	10000	-	-100	155	Inconel	P PC
R3B	150	-	0	60	SS316/316L	BG DW IA IN PW
R3C	300	-	0	60	SS316/316L	BG DW IA IN PW
R9B	150	1.6 mm	0	70	Carbon Steel	BG CHW DA OL SA SN W
R9C	300	1.6 mm	0	70	Carbon Steel	BG CHW DA OL SA SN W
S3B	150	-	0	60	SS316/316L	BG CNI DW H IA IN PW PWH
S3C	300	-	0	60	SS316/316L	BG CNI DW H IA IN PW PWH
S7	20 bar	-	0	75	Copper-Nickel	FW
S9B	150	1.6 mm	0	100	Carbon Steel	BG CHW CI DA OL S SA SC SN W
S9C	300	1.6 mm	0	100	Carbon Steel	BG CHW CI DA OL S SA SC SN W
T12	-	-	90	90	Tubing SuperDuplex	CI CNI
T3	-	-	60	60	Tubing SS316/316L	CI CNI

7 PIPING SPECIFICATION CODE RULE

SPEC CODE RULE: XYZ



Material	Code YY	Pressure Class or Type	Code X
Stainless Steel 316L	3	125	A
Carbon Steel API 5L, 1,6mm	4	150	B
Carbon Steel API 5L, 3,2mm	5	300	C
Low Temperature Carbon Steel ASTM A333 Gr6 e ASTM A671 CC60, 1,6mm	6	600	E
Cu-Ni 90/10	7	900	F
Galvanized Carbon Steel API 5L	8	1500	G
Carbon Steel API 5L, 3,2mm	9	2500	H
Carbon Steel API 5L, 1,6mm	10	10000	J
Organic Coated Carbon Steel API 5L	11	Gasket Mechanical Coupling (GMC)	R
Super Duplex Steel UNS S32760	12	Mechanically Attached Fittings (MAF)	S
Organic Coated Carbon Steel API 5L	14	Tubing	T
Duplex Steel UNS S31803	16		
Carbon Steel API 5L, 6,4mm	17	Other characteristics	Code Z
Low Temperature Carbon Steel ASTM A333 Gr6 e ASTM A671 CC60, 3,2mm	19	Reduced Pressure	R
PVC	20	ASME B31.4 or B31.8	P
CPVC	21	Hull Piping Spec.	H
FRP 90°C 10 bar	22	Class 150	B
FRP 90°C 16 bar	23	Class 300	C
FRP 120°C 16 bar	24		
RPVC	25		
FRP 120°C 16 bar	26		
FRP 85°C 16 bar	27		
Inconel 625 cladded Carbon Steel API 5L	30		
Alloy Steel 9Ni ASTM A 333 Gr8	31		
Inconel 625 cladded Alloy Steel 3 1/2Ni ASTM A 333 Gr3	32		
Inconel cladded Alloy Steel Aço Liga 9Ni ASTM A 333 Gr8	33		
Inconel 625 UNS N06625	40		



PETROBRAS

TECHNICAL SPECIFICATION	Nº. I-ET-3010.1M-1200-200-P4X-001	REV: F
AREA:	BÚZIOS	SHEET: 15 of 15
TITLE:	PIPING SPECIFICATION FOR TOPSIDE	NP-1
		ESUP

8 PIPING MATERIAL SPECIFICATIONS

		OFFSHORE PRODUCTION FACILITIES				Doc: I-ET-3010.1M-1200-200- P4X-001	Revision: F	Sheet 1 of 2
		PIPING SPECIFICATION FOR TOPSIDE					Issued by: SRGE/ESUP	Code: ASME B31.3

Services (see notes): AM - Amine; BG - Inert Gas; CNI - Corrosive Chemical Injection (Except Sodium Hypochlorite); D - Diesel; DW - Distilled Water; F - Safety System and Flare; FG - Fuel Gas; FLC - Concentrated Foam; G - Glycol; H - Hydraulic Fluid; IA - Instrumentation Air; IG - Instrumentation Gas; IGN - Ignition Line; IN - Instrumentation Nitrogen; JF - Aviation Kerosene; PC - Process (Corrosive Hydrocarbon); PW - Potable Water; PWH - Hot Fresh Water; W - Industrial water;	Material: SS 316/316L	Class: 150	Standard: B3
--	-----------------------------	---------------	-----------------

Pressure Rating (see notes)										
Temperature (°C)	-100	38	100	150	250	260				
Max Pressure (barg)	19.0	19.0	16.2	14.8	12.1	11.7				

Pipes and Fittings (see notes)															
	Items	Code	Size	Wall	Class	Ends	Standard	Material							
Pipes	Pipe	T-322	1/2" - 1 1/2"	S-40S	-	PE	ASME B36.19	ASTM A312 TP 316/316L SML							
		T-323	2" - 24"			BE	ASME B36.10/B36.19	ASTM A358 Type 316/316L Cl 1 or 3 WLD							
Fittings	90 Elbow	C01-43	1/2" - 1 1/2"	-	3000	SW	ASME B16.11	ASTM A182 Gr F316/316L							
	45 Elbow	C02-43													
	Tee	C03-43													
	Cross	C05-43													
	Coupling	C06-43													
	Cap	C11-43													
	Socketlet	C55-43	3/4" - 1 1/2"	-	3000	SW	ASME B16.11	ASTM A182 Gr F316/316L							
	Red Tee	C04-43													
	Red Coupling	C08-43													
	Weldolet	C12-43	2" - 18"	According to pipe	-	BE	ASME B16.9	ASTM A403 Gr WP316/316L							
	90 LR Elbow	C15-44													
	45 LR Elbow	C16-44													
	90 SR Elbow	C17-44													
	Tee	C20-44													
	Cap	C22-44													
Cross	C24-44														
Conc. Red	C18-44														
Ecc. Red	C19-44														
Red Tee	C21-44														
Nipple	Straight Nipple	N-S145	1/2" - 1 1/2"							According to pipe	-	PBE	ASTM A733	ASTM A312 TP316/316L	
	Swage Conc Nipple	N-C144	3/4" - 1 1/2"									BLE x PSE	MSS SP-95	ASTM A403 Gr WP316/316L	
		N-C444	2" - 4"												
	Swage Ecc Nipple	N-E144	3/4" - 1 1/2"	2" - 4"	BLE x PSE	ASTM A403 Gr WP316/316L									
N-E444		2" - 4"													
Flanges	Socket Weld (SW)	F-150-JX	1/2" - 1 1/2"	According to pipe	Class 150	Raised Face	ASME B16.5	ASTM A182 Gr F316/316L							
	Welding Neck (WN)	F-150-KX	2" - 24"				max 350 bar			-	ASME B16.47 A				
			26" - 40"								ISO 6162-1				
	Blind	F-150-LX	1/2" - 3"				Class 150			Raised Face	ASME B16.5				
			26" - 40"								ASME B16.47 A				
Hyd One-Piece Flange	F-350-3X	1/2" - 3"	max 350 bar	-	ISO 6162-1										
Bolts & Gasket Nuts	Spiral-Wound	J-150-EH	1/2" - 40"	-	Class 150	Raised Face	ASME B16.20	AISI 316/graphite							
							ASME B1.1	A320 L7, Zn-Ni							
	Stud and Nuts	P-150-08	1/2" - 1 1/2"	-	-	-	ASME B1.1	A194 7L, Zn-Ni							



OFFSHORE PRODUCTION FACILITIES

Doc:
I-ET-3010.1M-1200-200-P4X-001

Revision:
F

Sheet:
2 of 2

PIPING SPECIFICATION FOR TOPSIDE

Material:
SS
316/316L

Class:
150

Standard:
B3

Valves (see notes)

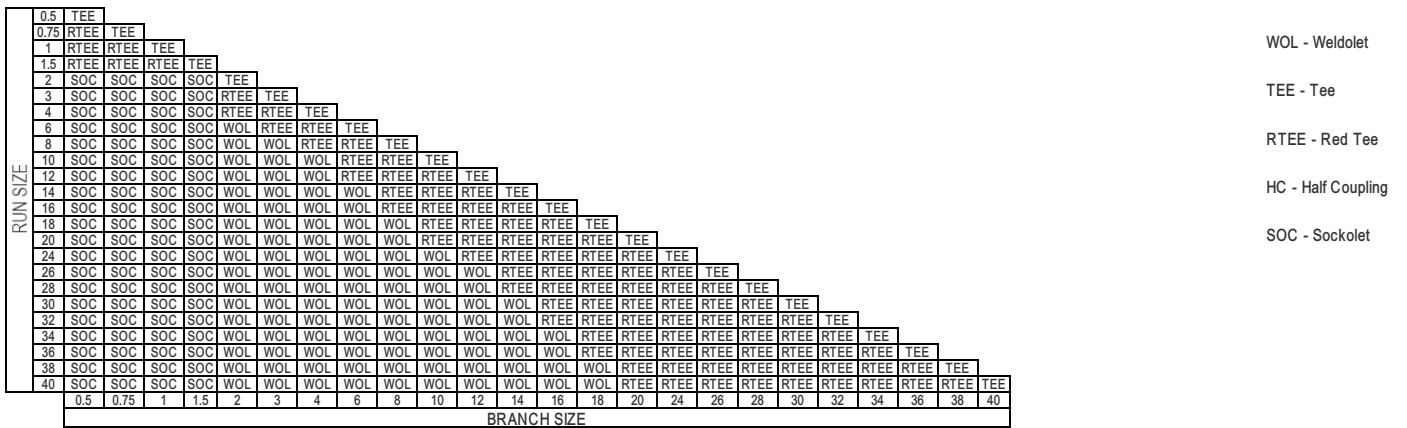

Type	Size	CODE	Temp	Type	Size	CODE	Temp	Type	Size	CODE	Temp	Type	Size	CODE	Temp
Needle	½" - 1 ½"	VAG-3000-1-S201	-100C to 200C	Ball	2" - 36"	VES-150-1-S260	0C to 210C	Ball	2" - 36"	VES-150-3-S226	0C to 150C	Double Ball	½" - 2"	VDE-150-2-S203	-100C to 150C
		VAG-3000-1-S202	-100C to 400C			VES-150-1-S270	-100C to 200C			VES-150-3-S227	0C to 150C			VDE-150-2-S204	-100C to 150C
VBO-250-1-U205	0C to 75C	VES-150-1-S280	-100C to 400C			VES-150-3-S236	-46C to 150C			VDE-150-2-S205	-100C to 200C				
VBO-150-2-S211	-46C to 150C	VES-150-2-S210	-30C to 150C			VES-150-3-S237	-30C to 150C			VDE-150-2-S206	-100C to 200C				
VBO-150-2-S212		VES-150-2-S216				VES-150-3-S252				VDE-150-2-S207	-100C to 340C				
Butterfly	6" - 24"	VBO-150-2-S213	-46C to 150C			VES-150-2-S220	0C to 150C			VES-150-3-S253	-30C to 150C			VDE-150-2-S208	-100C to 340C
		VBO-150-2-S216				-100C to 150C				VES-150-2-S226				0C to 210C	Gate
6" - 32"	VBO-150-2-S223	-100C to 345C	VES-150-2-S230			-46C to 150C	VES-150-3-S263			0C to 210C	VGA-150-1-S201			-46C to 400C	
	VBO-150-2-S221	-30C to 150C	VES-150-2-S236				-46C to 150C				VES-150-3-S272	-100C to 200C	VGA-150-2-S201		-29C to 400C
Ball	½" - 1 ½"	VES-801-1-S202	-46C to 150C			VES-150-2-S250	-30C to 150C			VES-150-3-S273	-100C to 200C	Globe	2" - 18"	VGL-150-1-S201	-29C to 400C
		VES-801-1-S205	-100C to 200C			VES-150-2-S252	-30C to 150C			VES-150-3-S282	-100C to 400C			VGL-150-2-S201	-46C to 400C
		VES-801-2-S201	-30C to 150C			VES-150-2-S260	0C to 210C			VES-150-3-S283	-100C to 400C	Plug	2" - 24"	VMA-150-2-S201	-30C to 93C
		VES-801-2-S202	-46C to 150C			VES-150-2-S262	0C to 210C			VES-150-4-S254	-30C to 150C			Check	½" - 1 ½"
		VES-801-2-S205	-100C to 200C			VES-150-2-S270	-100C to 200C			VES-150-4-S264	0C to 210C	VRE-800-2-S202	-100C to 400C		
		VES-801-3-S205	-100C to 200C			VES-150-2-S272	-100C to 200C			VES-150-4-S274	-100C to 200C	VRE-150-1-S211	0C to 150C		
		VES-150-1-S210	-30C to 150C			VES-150-2-S280	-100C to 400C			VES-150-4-S284	-100C to 400C	VRE-150-2-S212	-100C to 400C		
		VES-150-1-S220	0C to 150C			VES-150-2-S282	-100C to 400C			VDE-150-2-S201	-30C to 150C	VRE-150-2-S215	-100C to 400C		
		VES-150-1-S230	-46C to 150C			VES-150-3-S216	-30C to 150C			VDE-150-2-S202		VRE-150-2-S235	-46C to 150C		
		VES-150-1-S250	-30C to 150C	VES-150-3-S217	-30C to 150C										

Branch (see notes)



Notes

1	On the spec valve list, it may have valves codes which contain values of process data lower than spec limits. It shall be verified all valve process data (e.g.: pressure, temperature) in order to specify it according the design premisses.
2	See Annex A for valves requirements and general selection criteria.
3	Bolts,nuts and gaskets (only RTJ gaskets) must be Zn-Ni coated according to Annex B.
4	See Annex C for instruments, drains and vents typical piping arrangement.
5	Flanges ≤ 1 1/2" may be used, if strictly necessary.
6	See Annex E for Isolation gasket specifications.
7	Welding and Welding Inspection activities shall follow the requirements of these documents: I-ET-3010.00-1200-955-P4X-001-Welding and I-ET-3010.00-1200-955-P4X-002-Requirements for Welding Inspection
8	All valves, pipes and components specified for hydrogen sulfide service shall be in accordance with ISO 15156 requirements.
38	Stub in connections according to ASME B31.3 may be used only for flare system.
47	Diesel service "D" is only applicable for piping downstream the centrifuge.
51	Stainless Steel external coating shall be applied for the temperature limits acc. to I-ET-3010.00-1200-956-P4X-002 - General Painting.
54	This spec for PC service should only be used when recommended in annex D.
55	This spec for FG service is applicable for piping downstream the filters.
57	All standardized pipe wall thickness herein listed are calculated considering only internal pressure. Other loads resulting of the piping analysis (supporting, flexibility, fadigue) may increase minimum required thickness.
59	In case of use this spec below -30 °C, the material shall be furnished with solution heat treatment.
62	This spec for Amine service is applicable for piping downstream the Amine stripper up to booster pump suction.
120	Wafer valves are not to be used with flammable or combustible services, according to NFPA definition.
125	Materials shall follow the requirements of IOGP S-563- Material Data Sheets for Piping and Valve Components. Coating for bolts and nuts shall follow spec note number 3.
127	ISO 6162-1/2 flanges may be used only for H - Hydraulic Fluid.

		OFFSHORE PRODUCTION FACILITIES				Doc: I-ET-3010.1M-1200-200- P4X-001	Revision: F	Sheet 1 of 2
		PIPING SPECIFICATION FOR TOPSIDE					Issued by: SRGE/ESUP	Code: ASME B31.3



Services (see notes): HF - Hot Fluid; HWP - Process Heating Water; HWU - Utility Heating Water; S - Steam; SC - Steam Condensate;	Material: Carbon Steel	Class: 150	Standard: B4
--	----------------------------------	----------------------	------------------------

Pressure Rating (see notes)

Temperature (°C)	0	38	50	100	150	200	250	300				
Max Pressure (barg)	19.6	19.6	19.2	17.7	15.8	13.8	12.1	10.2				

Pipes and Fittings (see notes)

Items	Code	Size	Wall	Class	Ends	Standard	Material	
Pipes	Pipe	T-102	1/2" - 1 1/2"	XS	-	PE	API 5L Gr B PSL 1 SML	
			2" - 6"	STD		BE		ASME B36.10
			8" - 12"	S-20				
			14"	S-10				
			16" - 18"					
			20"					
24"	0.312"							
Fittings	90 Elbow	C 01-02	1/2" - 1 1/2"	-	3000	SW	ASME B16.11	ASTM A105
	45 Elbow	C 02-02						
	Tee	C 03-02						
	Cross	C 05-02						
	Coupling	C 06-02						
	Cap	C 11-02						
	Socketlet	C 55-02						
	Red Tee	C 04-02						
	Red Coupling	C 08-02						
	Weldolet	C 12-02						
	90 LR Elbow	C 15-03	2" - 24"	According to pipe	-	BE	ASME B16.9	ASTM A234 Gr WPB
	45 LR Elbow	C 16-03						
	90 SR Elbow	C 17-03						
	Tee	C 20-03						
	Cap	C 22-03						
	Cross	C 24-03						
	Conc. Red	C 18-03						
	Ecc. Red	C 19-03						
	Red Tee	C 21-03						
	3" - 24"							
Nipple	Straight Nipple	N-S120	1/2" - 1 1/2"	According to pipe	-	PBE	ASTM A733	API 5L Gr B PSL 1 seamless
	Swage Conc Nipple	N-C103	3/4" - 1 1/2"			BLE x PSE	MSS SP-95	ASTM A234 Gr WPB
		N-C403	2" - 4"					
	Swage Ecc Nipple	N-E103	3/4" - 1 1/2"			2" - 4"	BLE x PSE	
		N-E403						
Bolts & Gasket/Flanges	Socket Weld (SW)	F-150-J2	1/2" - 1 1/2"	According to pipe	Class 150	Raised Face	ASME B16.5	ASTM A105
	Welding Neck (WN)	F-150-K2	2" - 24"					
	Blind	F-150-L2	1/2" - 24"					
Bolts & Nuts	Spiral-Wound	J-150-EH	1/2" - 24"	-	Class 150	Raised Face	ASME B16.20	AISI 316/graphite
								Stud and Nuts

		OFFSHORE PRODUCTION FACILITIES	Doc: I-ET-3010.1M-1200-200-P4X-001	Revision: F	Sheet: 2 of 2
	PIPING SPECIFICATION FOR TOPSIDE			Material: Carbon Steel	Class: 150

Valves (see notes)



Type	Size	CODE	Temp	Type	Size	CODE	Temp	Type	Size	CODE	Temp	Type	Size	CODE	Temp
Needle	½" - 1 ½"	VAG-3000-1-S201	-100C to 200C	Ball	2" - 24"	VES-802-3-C105	0C to 210C	Gate	½" - 1 ½"	VGA-801-1-C101	-29C to 400C	Gate	2" - 24"	VGA-150-2-C102	-29C to 400C
		VAG-3000-1-S202	-100C to 400C			VES-150-1-C160				VGA-801-1-C102			2" - 18"	VGL-150-1-C102	-29C to 400C
Butterfly	6" - 24"	VBO-150-2-C112	-29C to 240C			VES-150-2-C160				VGA-801-2-C101		Check	½" - 1 ½"	VRE-800-1-C103	-29C to 400C
	10" - 24"	VBO-150-3-C123	0C to 210C			VES-150-2-C162				VGA-150-1-C101				2" - 24"	
Ball	½" - 1 ½"	VES-802-1-C105	0C to 210C	VES-150-3-C162	VGA-150-1-C102	VRE-150-2-C113									
		VES-802-2-C105	VES-150-3-C163	VGA-150-2-C101											

Branch (see notes)

Run Size	0.5 TEE	0.75 RTEE TEE	1 RTEE RTEE TEE	1.5 RTEE RTEE RTEE TEE	2 SOC SOC SOC SOC TEE	3 SOC SOC SOC SOC RTEE TEE	4 SOC SOC SOC SOC RTEE RTEE TEE	6 SOC SOC SOC SOC WOL RTEE RTEE TEE	8 SOC SOC SOC SOC WOL WOL RTEE RTEE TEE	10 SOC SOC SOC SOC WOL WOL WOL RTEE RTEE TEE	12 SOC SOC SOC SOC WOL WOL WOL WOL RTEE RTEE TEE	14 SOC SOC SOC SOC WOL WOL WOL WOL RTEE RTEE RTEE TEE	16 SOC SOC SOC SOC WOL WOL WOL WOL WOL RTEE RTEE RTEE TEE	18 SOC SOC SOC SOC WOL WOL WOL WOL WOL RTEE RTEE RTEE TEE	20 SOC SOC SOC SOC WOL WOL WOL WOL WOL WOL RTEE RTEE RTEE TEE	24 SOC SOC SOC SOC WOL WOL WOL WOL WOL WOL WOL RTEE RTEE RTEE TEE
Branch Size	0.5	0.75	1	1.5	2	3	4	6	8	10	12	14	16	18	20	24

Notes

1	On the spec valve list, it may have valves codes which contain values of process data lower than spec limits. It shall be verified all valve process data (e.g.: pressure, temperature) in order to specify it according the design premisses.
2	See Annex A for valves requirements and general selection criteria.
4	See Annex C for instruments, drains and vents typical piping arrangement.
5	Flanges ≤ 1 1/2" may be used, if strictly necessary.
7	Welding and Welding Inspection activities shall follow the requeriments of these documents: I-ET-3010.00-1200-955-P4X-001-Welding and I-ET-3010.00-1200-955-P4X-002-Requirements for Welding Inspection
125	Materials shall follow the requirements of IOGP S-563- Material Data Sheets for Piping and Valve Components. Coating for bolts and nuts shall follow spec note number 3.

 PETROBRAS		OFFSHORE PRODUCTION FACILITIES				Doc: I-ET-3010.1M-1200-200-P4X-001	Revision: F	Sheet 1 of 2
		PIPING SPECIFICATION FOR TOPSIDE					Issued by: SRGE/ESUP	Code: ASME B31.3

Services (see notes): F - Safety System and Flare; FG - Fuel Gas; G - Glycol; GL - Refrigerated Liquefied Petroleum Gases in Low Temperature; P - Process (non-corrosive hydrocarbon);	Material: Low Temp CS	Class: 150	Standard: B6
--	---------------------------------	----------------------	------------------------

Pressure Rating (see notes)										
Temperature (°C)	-46	0	38	50	100	150	200	240		
Max Pressure (barg)	18.4	18.4	18.4	18.2	17.4	15.8	13.8	12.4		

Pipes and Fittings (see notes)

Items	Code	Size	Wall	Class	Ends	Standard	Material	
Pipes	Pipe	T-105	1/2" - 1 1/2"	S-160	-	PE	ASTM A333 Gr 6 SML	
			2" - 6"	STD		BE		
			8" - 12"	S-20				
		14"	S-10	ASME B36.10				
	T-106	16" - 36"					ASTM A671 Gr CC60 Class 22 WLD	
Fittings	90 Elbow	C01-04	1/2" - 1 1/2"	-	6000	SW	ASME B16.11	ASTM A350 Gr LF2 Cl 1
	45 Elbow	C02-04						
	Tee	C03-04						
	Cross	C05-04						
	Coupling	C06-04						
	Cap	C11-04						
	Socketlet	C55-04	3/4" - 1 1/2"	-	-	ASME B16.11	MSS SP-97	
	Red Tee	C04-04						
	Red Coupling	C08-04	2" - 36"	According to pipe	-	BE	ASME B16.9	ASTM A420 Gr WPL6
	Weldolet	C12-04						
	90 LR Elbow	C15-05						
	45 LR Elbow	C16-05						
	90 SR Elbow	C17-05						
	Tee	C20-05						
	Cap	C22-05						
	Cross	C24-05						
Conc. Red	C18-05							
Ecc. Red	C19-05							
Red Tee	C21-05	3" - 36"	-	-	-	-	-	
Nipple	Straight Nipple	N-S137	1/2" - 1 1/2"	According to pipe	-	PBE	ASTM A733	ASTM A333 Gr 6
	Swage Conc Nipple	N-C105	3/4" - 1 1/2"			BLE x PSE	MSS SP-95	ASTM A420 Gr WPL6
		N-C405	2" - 4"					
	Swage Ecc Nipple	N-E105	3/4" - 1 1/2"			2" - 4"	PBE	
N-E405		2" - 4"	BLE x PSE					
Flanges	Socket Weld (SW)	F-150-J3	1/2" - 1 1/2"	According to pipe	Class 150	Raised Face	ASME B16.5	ASTM A350 Gr LF2 Class 1
	Welding Neck (WN)	F-150-K3	2" - 24"				ASME B16.47 A	
			26" - 36"				ASME B16.5	
	Blind	F-150-L3	1/2" - 24"				ASME B16.47 A	
			26" - 36"					
Bolts & Gasket Nuts	Spiral-Wound	J-150-EH	1/2" - 36"	-	Class 150	Raised Face	ASME B16.20	AISI 316/graphite
	Stud and Nuts	P-150-07	1/2" - 1 1/2"	-	-	-	ASME B1.1	A193 B7, Zn-Ni A194 Gr 2H, Zn-Ni

Valves (see notes)



Type	Size	CODE	Temp	Type	Size	CODE	Temp	Type	Size	CODE	Temp	Type	Size	CODE	Temp						
Needle	½" - 1 ½"	VAG-3000-1-S201	-100C to 200C	Ball	2" - 36"	VES-150-1-C280	-100C to 345C	Ball	2" - 36"	VES-150-3-C236	-46C to 150C	Double Ball	½" - 2"	VDE-150-2-C206	-46C to 200C						
		VAG-3000-1-S202	-100C to 400C							VES-150-2-C210	-30C to 150C					VES-150-3-C237	-46C to 340C			VDE-150-2-C207	-46C to 340C
Butterfly	6" - 32"	VBO-150-2-C213	-46C to 240C							VES-150-2-C216	-46C to 150C					VES-150-3-C252	-30C to 150C			VDE-150-2-C208	-30C to 150C
	10" - 32"	VBO-150-3-C223	-46C to 240C							VES-150-2-C230	-46C to 150C					VES-150-3-C253	-100C to 200C			VDE-150-2-C215	-30C to 150C
Ball	½" - 1 ½"	VES-803-1-C201	-30C to 150C							VES-150-2-C236	-100C to 200C	Double Ball	½" - 2"	VES-150-3-C272	-100C to 345C	Globe	2" - 18"	VGL-150-1-C201	-46C to 345C		
		VES-803-1-C205	-30C to 200C							VES-150-2-C250	-30C to 150C							VES-150-3-C273	-100C to 345C		
		VES-803-2-C201	-30C to 150C					VES-150-2-C252	-100C to 200C					VES-150-3-C282	-100C to 345C					VMA-150-2-C201	-46C to 345C
		VES-803-2-C205	-46C to 200C					VES-150-2-C270	-100C to 200C					VES-150-3-C283	-30C to 150C					VRE-800-1-C202	-46C to 345C
		VES-803-3-C205	-30C to 200C					VES-150-2-C272	-100C to 200C					VDE-150-2-C201	-30C to 150C			VRE-800-2-C202	0C to 345C		
	2" - 36"	VES-150-1-C210	-30C to 150C					VES-150-2-C280	-100C to 345C	Double Ball	½" - 2"	VDE-150-2-C202	-46C to 150C	Check	2" - 32"	VRE-150-1-C211	0C to 345C				
		VES-150-1-C230	-46C to 150C					VES-150-3-C216	-30C to 150C							VDE-150-2-C203	-46C to 150C			VRE-150-2-C212	-46C to 345C
		VES-150-1-C250	-30C to 150C					VES-150-3-C217	-100C to 200C							VDE-150-2-C204	-46C to 150C			VRE-150-2-C215	-46C to 210C
		VES-150-1-C270	-100C to 200C													VDE-150-2-C205	-46C to 200C				

Branch (see notes)

Run Size	0.5	0.75	1	1.5	2	3	4	6	8	10	12	14	16	18	20	24	26	28	30	32	34	36	
	TEE	RTEE	RTEE	TEE	TEE	TEE	TEE	TEE	TEE	TEE	TEE	TEE	TEE	TEE	TEE	TEE	TEE	TEE	TEE	TEE	TEE	TEE	TEE
	RTEE	RTEE	RTEE	RTEE	RTEE	RTEE	RTEE	RTEE	RTEE	RTEE	RTEE	RTEE	RTEE	RTEE	RTEE	RTEE	RTEE	RTEE	RTEE	RTEE	RTEE	RTEE	RTEE
	SOC	SOC	SOC	SOC	SOC	SOC	SOC	SOC	SOC	SOC	SOC	SOC	SOC	SOC	SOC	SOC	SOC	SOC	SOC	SOC	SOC	SOC	SOC
	WOL	WOL	WOL	WOL	WOL	WOL	WOL	WOL	WOL	WOL	WOL	WOL	WOL	WOL	WOL	WOL	WOL	WOL	WOL	WOL	WOL	WOL	WOL
	WOL	WOL	WOL	WOL	WOL	WOL	WOL	WOL	WOL	WOL	WOL	WOL	WOL	WOL	WOL	WOL	WOL	WOL	WOL	WOL	WOL	WOL	WOL
	WOL	WOL	WOL	WOL	WOL	WOL	WOL	WOL	WOL	WOL	WOL	WOL	WOL	WOL	WOL	WOL	WOL	WOL	WOL	WOL	WOL	WOL	WOL
	WOL	WOL	WOL	WOL	WOL	WOL	WOL	WOL	WOL	WOL	WOL	WOL	WOL	WOL	WOL	WOL	WOL	WOL	WOL	WOL	WOL	WOL	WOL
	WOL	WOL	WOL	WOL	WOL	WOL	WOL	WOL	WOL	WOL	WOL	WOL	WOL	WOL	WOL	WOL	WOL	WOL	WOL	WOL	WOL	WOL	WOL
	WOL	WOL	WOL	WOL	WOL	WOL	WOL	WOL	WOL	WOL	WOL	WOL	WOL	WOL	WOL	WOL	WOL	WOL	WOL	WOL	WOL	WOL	WOL
	WOL	WOL	WOL	WOL	WOL	WOL	WOL	WOL	WOL	WOL	WOL	WOL	WOL	WOL	WOL	WOL	WOL	WOL	WOL	WOL	WOL	WOL	WOL
	WOL	WOL	WOL	WOL	WOL	WOL	WOL	WOL	WOL	WOL	WOL	WOL	WOL	WOL	WOL	WOL	WOL	WOL	WOL	WOL	WOL	WOL	WOL
	WOL	WOL	WOL	WOL	WOL	WOL	WOL	WOL	WOL	WOL	WOL	WOL	WOL	WOL	WOL	WOL	WOL	WOL	WOL	WOL	WOL	WOL	WOL
	WOL	WOL	WOL	WOL	WOL	WOL	WOL	WOL	WOL	WOL	WOL	WOL	WOL	WOL	WOL	WOL	WOL	WOL	WOL	WOL	WOL	WOL	WOL
	WOL	WOL	WOL	WOL	WOL	WOL	WOL	WOL	WOL	WOL	WOL	WOL	WOL	WOL	WOL	WOL	WOL	WOL	WOL	WOL	WOL	WOL	WOL
	WOL	WOL	WOL	WOL	WOL	WOL	WOL	WOL	WOL	WOL	WOL	WOL	WOL	WOL	WOL	WOL	WOL	WOL	WOL	WOL	WOL	WOL	WOL
	WOL	WOL	WOL	WOL	WOL	WOL	WOL	WOL	WOL	WOL	WOL	WOL	WOL	WOL	WOL	WOL	WOL	WOL	WOL	WOL	WOL	WOL	WOL
	WOL	WOL	WOL	WOL	WOL	WOL	WOL	WOL	WOL	WOL	WOL	WOL	WOL	WOL	WOL	WOL	WOL	WOL	WOL	WOL	WOL	WOL	WOL
	WOL	WOL	WOL	WOL	WOL	WOL	WOL	WOL	WOL	WOL	WOL	WOL	WOL	WOL	WOL	WOL	WOL	WOL	WOL	WOL	WOL	WOL	WOL

Notes

- On the spec valve list, it may have valves codes which contain values of process data lower than spec limits. It shall be verified all valve process data (e.g.: pressure, temperature) in order to specify it according the design premisses.
- See Annex A for valves requirements and general selection criteria.
- Bolts,nuts and gaskets (only RTJ gaskets) must be Zn-Ni coated according to Annex B.
- See Annex C for instruments, drains and vents typical piping arrangement.
- Flanges ≤ 1 1/2" may be used, if strictly necessary .
- See Annex E for Isolation gasket specifications.
- Welding and Welding Inspection activities shall follow the requeriments of these documents: I-ET-3010.00-1200-955-P4X-001-Welding and I-ET-3010.00-1200-955-P4X-002-Requirements for Welding Inspection
- All valves, pipes and components specified for hydrogen sulfide service shall be in accordance with ISO 15156 requirements.
- Charpy impact test is required at the minimum temperature of this spec, according to ASME B31.3 and standard material specification.
- Stub in connections according to ASME B31.3 may be used only for flare system.
- Wafer valves are not to be used with flammable or combustible services, according to NFPA definition.
- Materials shall follow the requirements of IOGP S-563- Material Data Sheets for Piping and Valve Components. Coating for bolts and nuts shall follow spec note number 3.



		OFFSHORE PRODUCTION FACILITIES				Doc: I-ET-3010.1M-1200-200- P4X-001	Revision: F	Sheet 1 of 2
		PIPING SPECIFICATION FOR TOPSIDE					Issued by: SRGE/ESUP	Code: ASME B31.3

Services (see notes): FL - Foam Line; FW - Fire Water (Sea Water);	Material: Copper-Nickel	Class: 20 bar	Standard: B7
---	----------------------------	------------------	-----------------

Pressure Rating (see notes)									
Temperature (°C)	0	38	50	75					
Max Pressure (barg)	19.6	19.6	19.2	18.4					

Pipes and Fittings (see notes)

Items	Code	Size	Wall	Class	Ends	Standard	Material	
Pipes	Pipe	T-202	1/2" - 3/4"	2.0mm	-	PE	EEMUA 234	Cu-Ni 90/10 (UNS C70620) SML
			1" - 2"	2.5mm		BE		
			2 1/2" - 3"	3.0mm				
			4"	3.5mm				
			6"	4.5mm				
			8"	5.5mm				
			10"	7.0mm				
			12"	8.0mm				
			14"	9.0mm				
			16"	9.5mm				
			20"	11.0mm				
			24"	13.0mm				
			28"	15.0mm				
32"	17.0mm							
36"	19.0mm							
Fittings	90 Elbow	C01-35	-	20 bar	-	EEMUA 234	Cu-Ni 90/10 (UNS C70620)	
	45 Elbow	C02-35						
	Tee	C03-35						
	Coupling	C06-35						
	Plug	C09-35						
	Union	C10-35						
	Cap	C11-35						
	Connector	C37-35						
	Connector Union	C38-35						
	Socket	C55-35						
	Red Coupling	C08-35						
	Bush	C23-35						
	Weldolet	C12-35						
	90 LR Elbow	C15-35						
	45 LR Elbow	C16-35						
	Tee	C20-35						
	Cap	C22-35						
	Conc. Red	C18-35						
Ecc. Red	C19-35							
Red Tee	C21-35							
Stub End WN-L	C39-35							
Nipple	Connector Nipple	N-A335	According to pipe	-	-	EEMUA 234	Cu-Ni 90/10 (UNS C70620)	
		N-A735						
		N-A835						
Flanges	Slip on (SO)	F-20-HM	According to pipe	20 bar	Class 150	Raised Face	ASTM A105 Thermal Spray coated (note 126)	
	Blind	F-150-LY						
	Backing Flange	F-20-Y2						
Gasket	Flat type	J-150-P4	-	Class 150	Raised Face	ASME B16.21	Compressed sheet, fire-tested	
Bolts & Nuts	Stud and Nuts	P-150-07	1/2" - 1 1/2"	-	-	ASME B1.1	A193 B7, Zn-Ni	
							A194 Gr 2H, Zn-Ni	

 PETROBRAS		OFFSHORE PRODUCTION FACILITIES	Doc: I-ET-3010.1M-1200-200-P4X-001	Revision: F	Sheet: 2 of 2
	PIPING SPECIFICATION FOR TOPSIDE			Material: Copper-Nickel	Class: 20 bar

Valves (see notes)



Type	Size	CODE	Temp	Type	Size	CODE	Temp	Type	Size	CODE	Temp	Type	Size	CODE	Temp			
Butterfly	6" - 36"	VBO-150-2-U311	-46C to 75C	Ball	6" - 36"	VBO-150-3-U323	-29C to 75C	Diaphragm	2" - 12"	VDI-300-2-U301	0C to 80C	Globe	2" - 18"	VGL-150-1-U301	-46C to 75C			
		VBO-150-2-U312				VES-150-1-U300				VAN-150-1-U101				0C to 75C				
		VBO-150-2-U313	0C to 90C			VES-150-2-U300				-29C to 75C	Gate			1/2" - 1 1/2"	VGA-200-1-U101	0C to 75C	VRE-200-1-U122	0C to 75C
		VBO-150-2-U317	-46C to 75C			VES-150-1-U310					0C to 75C			Globe	1/2" - 1 1/2"		VGL-150-1-U101	
		VBO-150-2-U318				VES-150-2-U310								-46C to 75C	Gate	1"	VGA-150-1-U301	VRE-150-1-U312
VBO-150-2-U319	0C to 90C	VES-150-2-U311	VGA-150-2-U301	VRE-150-2-U332	0C to 75C													

Branch (see notes)

WOL - Weldolet
TEE - Tee
RTEE - Red Tee
HC - Half Coupling
SOC - Sockolet

Notes

1	On the spec valve list, it may have valves codes which contain values of process data lower than spec limits. It shall be verified all valve process data (e.g.: pressure, temperature) in order to specify it according the design premisses.
2	See Annex A for valves requirements and general selection criteria.
3	Bolts, nuts and gaskets (only RTJ gaskets) must be Zn-Ni coated according to Annex B.
4	See Annex C for instruments, drains and vents typical piping arrangement.
6	See Annex E for Isolation gasket specifications.
7	Welding and Welding Inspection activities shall follow the requirements of these documents: I-ET-3010.00-1200-955-P4X-001-Welding and I-ET-3010.00-1200-955-P4X-002-Requirements for Welding Inspection
53	This spec must be used only for offshore facilities.
86	Pipes in this spec do not take account additional thickness for threads. Must be evaluated pipes thicker than these here specified if threaded pipe will be applied.
87	Piping, connections and flanges should be specified according EEMUA 144/145/146.
104	The backing flange and stub ends are part of the composite flange according EEMUA 234.
110	Epoxy coating for flanges shall be applied according to I-ET-3010.00-1200-956-P4X-002 - General Painting.
115	Gaskets shall not be used to assembly butterfly valves API 609 category A, unless required by the valve manufacturer.
125	Materials shall follow the requirements of IOGP S-563- Material Data Sheets for Piping and Valve Components. Coating for bolts and nuts shall follow spec note number 3.
126	Thermal spray application shall be according to the requirements of I-ET-3010.00-1200-956-P4X-003. Consumable specification: AWS C2.25m: W-CuAl-1 or ISO 14919: CuAl10.



		OFFSHORE PRODUCTION FACILITIES				Doc: I-ET-3010.1M-1200-200- P4X-001	Revision: F	Sheet 1 of 2
		PIPING SPECIFICATION FOR TOPSIDE					Issued by: SRGE/ESUP	Code: ASME B31.3

Services (see notes): FL - Foam Line; FW - Fire Water (Sea Water); SW - Aerated Sea Water;	Material: Copper-Nickel	Class: 16 bar	Standard: B7R
---	----------------------------	------------------	------------------

Pressure Rating (see notes)										
Temperature (°C)	0	38	50	75						
Max Pressure (barg)	16	16	16	16						

Pipes and Fittings (see notes)

Items	Code	Size	Wall	Class	Ends	Standard	Material	
Pipes	Pipe	T-202	1/2" - 3/4"	2.0mm	-	PE	EEMUA 234	Cu-Ni 90/10 (UNS C70620) SML
			1" - 2"	2.5mm		BE		
			2 1/2" - 3"	3.0mm				
			4"					
			6"	4.0mm				
			8"					
			10"	4.5mm				
			12"	5.5mm				
			14"	6.5mm				
			16"	7.0mm				
			18"	8.0mm				
			20"	8.5mm				
			24"	10.5mm				
28"	12.0mm							
32"	13.5mm							
36"	15.5mm							
Fittings	90 Elbow	C01-35	1/2" - 1 1/2"	-	20 bar	Fcap	EEMUA 234	Cu-Ni 90/10 (UNS C70620)
	45 Elbow	C02-35						
	Tee	C03-35						
	Coupling	C06-35						
	Plug	C09-35						
	Union	C10-35						
	Cap	C11-35						
	Connector	C37-35						
	Connector Union	C38-35						
	Socket	C55-35				1/2" - 2"		
	Red Coupling	C08-35	3/4" - 1 1/2"	20 bar	Fcap			
					Mcap x Fcap			
	Weldolet	C12-35	2" - 16"	According to pipe	-	BE		
	90 LR Elbow	C15-35						
	45 LR Elbow	C16-35						
	Tee	C20-35						
	Cap	C22-35						
	Conc. Red	C18-35						
	Ecc. Red	C19-35						
	Red Tee	C21-35						
Stub End WN-L	C39-35	4"	20 bar			BE		
		6" - 36"	16 bar					
Nipple	Connector Nipple	N-A335	3/4" - 1 1/2"	According to pipe	-	TBE	EEMUA 234	Cu-Ni 90/10 (UNS C70620)
		N-A735						
		N-A835						
Flanges	Slip on (SO)	F-20-HM	1/2" - 1 1/2"	According to pipe	20 bar	EEMUA 234	ASTM A105 Thermal Spray coated (note 126)	
	Blind	F-150-LY	1/2" - 24"		Class 150	Raised Face		ASME B16.5
	Backing Flange	F-20-Y2	28" - 36"			20 bar		Raised Face
Gasket	Flat type	J-150-P4	1/2" - 36"	-	Class 150	Raised Face	ASME B16.21	Compressed sheet, fire-tested
Bolts & Nuts	Stud and Nuts	P-150-07	1/2" - 1 1/2"	-	-	-	ASME B1.1	A193 B7, Zn-Ni



 PETROBRAS		OFFSHORE PRODUCTION FACILITIES				Doc: I-ET-3010.1M-1200-200-P4X-001	Revision: F	Sheet 1 of 2
		PIPING SPECIFICATION FOR TOPSIDE					Issued by: SRGE/ESUP	Code: ASME B31.3

Services (see notes): AM - Amine; DA - Open Drain; DFC - Closed Drain (Corrosive Hydrocarbon); F - Safety System and Flare; PC - Process (Corrosive Hydrocarbon);	Material: Carbon Steel	Class: 150	Standard: B9
---	----------------------------------	----------------------	------------------------

Pressure Rating (see notes)										
Temperature (°C)	-29	0	38	50	100	150	200	240		
Max Pressure (barg)	19.6	19.6	19.6	19.2	17.7	15.8	13.8	12.4		

Pipes and Fittings (see notes)

Items	Code	Size	Wall	Class	Ends	Standard	Material	
Pipes	Pipe	T-102	1/2" - 1 1/2"	S-160	-	PE	ASME B36.10	API 5L Gr B PSL 1 SML
			2"	XS		BE		API 5L Gr B PSL 1 (SML or WLD HFW or WLD SAW)
			3" - 6"	STD				
			8" - 10"	S-20				
			12"	0.281"				
			14"	S-20				
			16" - 18"					
			20" - 24"	STD				
			26" - 28"					
			30" - 32"					
34"	0.438"							
36"	0.469"		API 5L Gr B PSL 1 WLD SAW					
Fittings	90 Elbow	C 01-02	1/2" - 1 1/2"	-	6000	SW	ASME B16.11	ASTM A105
	45 Elbow	C 02-02						
	Tee	C 03-02						
	Cross	C 05-02						
	Coupling	C 06-02						
	Cap	C 11-02						
	Socket	C 55-02						
	Red Tee	C 04-02						
	Red Coupling	C 08-02						
	Weldolet	C 12-02						
	90 LR Elbow	C 15-03	2" - 36"	According to pipe	-	BE	ASME B16.9	ASTM A234 Gr WPB
	45 LR Elbow	C 16-03						
	90 SR Elbow	C 17-03						
	Tee	C 20-03						
	Cap	C 22-03						
	Cross	C 24-03						
	Conc. Red	C 18-03						
	Ecc. Red	C 19-03						
Red Tee	C 21-03							
3" - 36"								
Nipple	Straight Nipple	N-S120	1/2" - 1 1/2"	According to pipe	-	PBE	ASTM A733	API 5L Gr B PSL 1 seamless
	Swage Conc Nipple	N-C103	3/4" - 1 1/2"			BLE x PSE	MSS SP-95	ASTM A234 Gr WPB
		N-C403	2" - 4"					
	Swage Ecc Nipple	N-E103	3/4" - 1 1/2"			2" - 4"		
		N-E403						
Flanges	Socket Weld (SW)	F-150-J2	1/2" - 1 1/2"	According to pipe	Class 150	Raised Face	ASME B16.5	ASTM A105
	Welding Neck (WN)	F-150-K2	2" - 24"					
			26" - 36"					
	Blind	F-150-L2	1/2" - 24"					
26" - 36"								
Bolts & Nuts	Spiral-Wound	J-150-EH	1/2" - 36"	-	Class 150	Raised Face	ASME B16.20	AISI 316/graphite
	Stud and Nuts	P-150-07	1/2" - 1 1/2"	-	-	-	ASME B1.1	A193 B7, Zn-Ni A194 Gr 2H, Zn-Ni

		OFFSHORE PRODUCTION FACILITIES				Doc: I-ET-3010.1M-1200-200- P4X-001	Revision: F	Sheet 1 of 2
		PIPING SPECIFICATION FOR TOPSIDE					Issued by: SRGE/ESUP	Code: ASME B31.3

Services (see notes): AM - Amine; BG - Inert Gas; CHW - Chilled Water; CI - Chemical Injection (non-corrosive); D - Diesel; DF - Closed Drain (Non-Corrosive hydrocarbon); F - Safety System and Flare; FG - Fuel Gas; FL - Foam Line; G - Glycol; IW - De-Aerated Sea Water Injection; OL - Lubricating Oil; P - Process (non-corrosive hydrocarbon); SA - Service Compressed Air (utility Air); SN - Start-up Nitrogen; W - Industrial water;	Material: Carbon Steel	Class: 150	Standard: B10
--	----------------------------------	----------------------	-------------------------

Pressure Rating (see notes)										
Temperature (°C)	-29	0	38	50	100	150	200			
Max Pressure (barg)	19.6	19.6	19.6	19.2	17.7	15.8	13.8			

Pipes and Fittings (see notes)

Items	Code	Size	Wall	Class	Ends	Standard	Material						
Pipes	Pipe	T-102	1/2" - 1 1/2"	S-160	-	PE	API 5L Gr B PSL 1 SML						
			2" - 6"	STD		BE		ASME B36.10	API 5L Gr B PSL 1 (SML or WLD HFW or WLD SAW)				
			8" - 12"	S-20									
			14"	S-10									
			16" - 18"										
			20"				0.281"	API 5L Gr B PSL 1 WLD (HFW or SAW)					
			24"				0.312"						
			26" - 28"	S-10									
			30" - 32"	0.344"		API 5L Gr B PSL 1 WLD SAW							
34" - 36"	STD												
Fittings	90 Elbow	C01-02	1/2" - 1 1/2"	-	6000	SW	ASME B16.11	ASTM A105					
	45 Elbow	C02-02											
	Tee	C03-02											
	Cross	C05-02											
	Coupling	C06-02											
	Cap	C11-02											
	Socketlet	C55-02	3/4" - 1 1/2"	-	-	ASME B16.11	-						
	Red Tee	C04-02											
	Red Coupling	C08-02											
	Weldolet	C12-02	2" - 16"	According to pipe	-	BE	ASME B16.9	ASTM A234 Gr WPB					
	90 LR Elbow	C15-03											
	45 LR Elbow	C16-03											
	90 SR Elbow	C17-03											
	Tee	C20-03											
	Cap	C22-03											
	Cross	C24-03											
	Conc. Red	C18-03											
	Ecc. Red	C19-03											
Red Tee	C21-03												
Nipple	Straight Nipple	N-S120	1/2" - 1 1/2"						According to pipe	-	PBE	ASTM A733	API 5L Gr B PSL 1 seamless
	Swage Conc Nipple	N-C103	3/4" - 1 1/2"								BLE x PSE	MSS SP-95	ASTM A234 Gr WPB
		N-C403	2" - 4"										
	Swage Ecc Nipple	N-E103	3/4" - 1 1/2"	2" - 4"	BLE x PSE	-	-						
N-E403		2" - 4"											
Flanges	Socket Weld (SW)	F-150-J2	1/2" - 1 1/2"	According to pipe	Class 150	Raised Face	ASME B16.5	ASTM A105					
	Welding Neck (WN)	F-150-K2	2" - 24"				ASME B16.47 A						
			26" - 36"				ASME B16.5						
	Blind	F-150-L2	1/2" - 24"				ASME B16.47 A						
26" - 36"			ASME B16.47 A										
Bolts & Gasket Nuts	Spiral-Wound	J-150-EH	1/2" - 36"	-	Class 150	Raised Face	ASME B16.20	AISI 316/graphite					
	Stud and Nuts	P-150-07	1/2" - 1 1/2"	-	-	-	ASME B1.1	A193 B7, Zn-Ni A194 Gr 2H, Zn-Ni					



OFFSHORE PRODUCTION FACILITIES

Doc:
I-ET-3010.1M-1200-200-
P4X-001

Revision:
F

Sheet:
2 of 2

PIPING SPECIFICATION FOR TOPSIDE

Material:
Carbon
Steel

Class:
150

Standard:
B10

Valves (see notes)

Type	Size	CODE	Temp	Type	Size	CODE	Temp	Type	Size	CODE	Temp	Type	Size	CODE	Temp		
Needle	½" - 1 ½"	VAG-3000-1-S201	-100C to 200C	Ball	2" - 36"	VES-150-1-C150	0C to 150C	Ball	2" - 36"	VES-150-3-C116	-29C to 150C	Double Ball	½" - 2"	VDE-150-2-C102	-29C to 150C		
		VAG-3000-1-S202	-100C to 400C			VES-150-1-C160	0C to 210C			VES-150-3-C117				-29C to 200C	VDE-150-2-C105	-29C to 200C	
Butterfly	2" - 24"	VBO-250-1-U204	0C to 75C			VES-150-1-C170	-29C to 150C			VES-150-3-C126					0C to 150C		VDE-150-2-C106
		VBO-250-1-U205				VES-150-1-C180				VES-150-3-C127							
	28" - 32"	VBO-250-1-U206	VES-150-2-C110			VES-150-3-C136											
	6" - 32"	VBO-150-2-C111	-29C to 150C			VES-150-3-C137				-29C to 150C				VBO-150-2-C112	VES-150-2-C111	VES-150-3-C152	
		VBO-150-2-C112	0C to 150C			VES-150-2-C116								VES-150-3-C153			
		VBO-150-2-C113	-29C to 240C			VES-150-2-C120								VES-150-3-C162			
VBO-150-3-C123		0C to 150C	VES-150-2-C126			VES-150-3-C163											
Ball	½" - 1 ½"	VES-803-1-C101	0C to 150C			VES-150-2-C130	0C to 210C			VES-150-3-C172	0C to 400C		Gate	2" - 36"	VGA-801-1-C101	-29C to 400C	
		VES-803-1-C102	0C to 210C			VES-150-2-C136	VES-150-3-C182			VGL-150-1-C101					-29C to 400C		
		VES-803-1-C105	-29C to 150C			VES-150-2-C150	VES-150-3-C183			VGL-150-2-C101					-29C to 400C		
		2" - 36"	VES-803-2-C101			0C to 150C	VES-150-2-C162			0C to 210C	VES-150-3-C184		0C to 150C	Plug	2" - 24"	VMA-150-2-C101	0C to 93C
			VES-803-2-C102			0C to 210C	VES-150-2-C170			0C to 210C	VRE-800-1-C103		-29C to 400C				
			VES-803-3-C105			0C to 150C	VES-150-2-C172			0C to 150C	VRE-800-2-C103		-29C to 400C				
	Ball	2" - 36"	VES-150-1-C110			-29C to 150C	VES-150-2-C180			0C to 400C	VES-150-4-C164		0C to 210C	Globe	2" - 20"	VRE-150-1-C111	0C to 150C
			VES-150-1-C120			0C to 150C	VES-150-2-C182			0C to 400C	VES-150-4-C174		-29C to 400C				
			VES-150-1-C130			0C to 150C	VES-150-2-C188			0C to 400C	VES-150-4-C184		-29C to 400C				
			VES-150-1-C130			0C to 150C	VES-150-2-C188			0C to 400C	VDE-150-2-C101		-29C to 210C				



Branch (see notes)

RUN SIZE	0.5	TEE																				
	0.75	RTEE	TEE																			
	1	RTEE	RTEE	TEE																		
	1.5	RTEE	RTEE	RTEE	TEE																	
	2	SOC	SOC	SOC	SOC	TEE																
	3	SOC	SOC	SOC	SOC	RTEE	TEE															
	4	SOC	SOC	SOC	SOC	RTEE	RTEE	TEE														
	6	SOC	SOC	SOC	SOC	WOL	RTEE	RTEE	TEE													
	8	SOC	SOC	SOC	SOC	WOL	WOL	RTEE	RTEE	TEE												
	10	SOC	SOC	SOC	SOC	WOL	WOL	WOL	RTEE	RTEE	TEE											
	12	SOC	SOC	SOC	SOC	WOL	WOL	WOL	RTEE	RTEE	RTEE	TEE										
	14	SOC	SOC	SOC	SOC	WOL	WOL	WOL	RTEE	RTEE	RTEE	TEE										
	18	SOC	SOC	SOC	SOC	WOL	WOL	WOL	RTEE	RTEE	RTEE	RTEE	TEE									
	20	SOC	SOC	SOC	SOC	WOL	WOL	WOL	WOL	RTEE	RTEE	RTEE	RTEE	TEE								
	24	SOC	SOC	SOC	SOC	WOL	WOL	WOL	WOL	RTEE	RTEE	RTEE	RTEE	TEE								
	28	SOC	SOC	SOC	SOC	WOL	WOL	WOL	WOL	WOL	RTEE	RTEE	RTEE	RTEE	TEE							
	30	SOC	SOC	SOC	SOC	WOL	WOL	WOL	WOL	WOL	RTEE	RTEE	RTEE	RTEE	TEE							
	32	SOC	SOC	SOC	SOC	WOL	WOL	WOL	WOL	WOL	RTEE	RTEE	RTEE	RTEE	TEE							
	34	SOC	SOC	SOC	SOC	WOL	WOL	WOL	WOL	WOL	WOL	RTEE	RTEE	RTEE	RTEE	TEE						
36	SOC	SOC	SOC	SOC	WOL	WOL	WOL	WOL	WOL	WOL	WOL	RTEE	RTEE	RTEE	RTEE	TEE						
	0.5	0.75	1	1.5	2	3	4	6	8	10	12	14	16	18	20	24	26	28	30	32	34	36

- WOL - Weldolet
- TEE - Tee
- RTEE - Red Tee
- HC - Half Coupling
- SOC - Sockolet

Notes

1	On the spec valve list, it may have valves codes which contain values of process data lower than spec limits. It shall be verified all valve process data (e.g.: pressure, temperature) in order to specify it according the design premisses.
2	See Annex A for valves requirements and general selection criteria.
3	Bolts, nuts and gaskets (only RTJ gaskets) must be Zn-Ni coated according to Annex B.
4	See Annex C for instruments, drains and vents typical piping arrangement.
5	Flanges ≤ 1 1/2" may be used, if strictly necessary.
6	See Annex E for isolation gasket specifications.
7	Welding and Welding Inspection activities shall follow the requirements of these documents: I-ET-3010.00-1200-955-P4X-001-Welding and I-ET-3010.00-1200-955-P4X-002-Requirements for Welding Inspection
8	All valves, pipes and components specified for hydrogen sulfide service shall be in accordance with ISO 15156 requirements.
38	Stub in connections according to ASME B31.3 may be used only for flare system.
40	The IW service is only applicable for onshore units.
43	The FL service is only applicable for onshore units.
46	Diesel service "D" is only applicable for piping upstream the centrifuge.
56	This spec for FG service is applicable for piping upstream the filters.
64	This spec for Amine service is applicable for piping downstream the regeneration unit and upstream the contactor unit.
115	Gaskets shall not be used to assembly butterfly valves API 609 category A, unless required required by the valve manufacturer.
120	Wafer valves are not to be used with flammable or combustible services, according to NFPA definition.
125	Materials shall follow the requirements of IOGP S-563- Material Data Sheets for Piping and Valve Components. Coating for bolts and nuts shall follow spec note number 3.

		OFFSHORE PRODUCTION FACILITIES				Doc: I-ET-3010.1M-1200-200- P4X-001	Revision: F	Sheet 1 of 2
		PIPING SPECIFICATION FOR TOPSIDE						Issued by: SRGE/ESUP

Services (see notes): ADW - Aerated Dilution Water; PC - Process (Corrosive Hydrocarbon); PCW - Produced water;	Material: Organic Coat CS	Class: 150	Standard: B11
--	---------------------------------	---------------	------------------

Pressure Rating (see notes)

Temperature (°C)	0	38	50	100	150						
Max Pressure (barg)	19.6	19.6	19.2	17.7	15.8						

Pipes and Fittings (see notes)

Items		Code	Size	Wall	Class	Ends	Standard	Material
Pipes	Pipe	T-102	1" - 1 1/2"	XS	-	PE	ASME B36.10	API 5L Gr B PSL 1 SML
			2" - 6"	STD		BE		API 5L Gr B PSL 1 (SML or WLD HFW or WLD SAW)
			8" - 12"	S-20				API 5L Gr B PSL 1 WLD (HFW or SAW)
			14"	S-10				API 5L Gr B PSL 1 WLD SAW
			16" - 24"					ASTM A105
26" - 28"	0.250"							
Fittings	Weldolet	C12-02	1" - 12"	According to pipe	-	BE	MSS SP-97	ASTM A105
	90 LR Elbow	C15-03	1" - 28"			-	ASME B16.9	ASTM A234 Gr WPB
	45 LR Elbow	C16-03						
	90 SR Elbow	C17-03						
	Tee	C20-03						
	Cap	C22-03						
	Cross	C24-03						
	Conc. Red	C18-03						
	Ecc. Red	C19-03						
Red Tee	C21-03							
Nipple	Swage Conc Nipple	N-C203	1 1/2" - 4"	According to pipe	-	BBE	MSS SP-95	ASTM A234 Gr WPB
	Swage Ecc Nipple	N-E203						
Flanges	Welding Neck (WN)	F-150-K2	1" - 24"	According to pipe	Class 150	Raised Face	ASME B16.5	ASTM A105
			26" - 28"				ASME B16.47 A	
	Blind	F-150-L2	1" - 24"				ASME B16.5	
			26" - 28"				ASME B16.47 A	
Gasket	Flat type	J-150-PC	1" - 28"	-	Class 150	Raised Face	ASME B16.21	Multidirectional Expanded PTFE
Bolts & Nuts	Stud and Nuts	P-150-07	1/2" - 1 1/4"	-	-	-	ASME B1.1	A193 B7, Zn-Ni
								A194 Gr 2H, Zn-Ni



NP-1

OFFSHORE PRODUCTION FACILITIES

Doc: I-ET-3010.1M-1200-200-P4X-001

Revision: F

Sheet: 2 of 2

PIPING SPECIFICATION FOR TOPSIDE

Material: Organic Coat CS
Class: 150
Standard: B11

Valves (see notes)

Type	Size	CODE	Temp	Type	Size	CODE	Temp	Type	Size	CODE	Temp	Type	Size	CODE	Temp
Needle	1" - 1 1/2"	VAG-150-1-D201	-50C to 150C	Ball	1" - 1 1/2"	VES-150-1-D200	0C to 150C	Double Ball	1" - 2"	VDE-150-2-D201	-30C to 150C	Globe	2" - 18"	VGL-150-2-D201	-46C to 150C
	2" - 24"	VBO-250-1-U207	0C to 80C		1" - 1 1/2"	VES-150-2-D200			1" - 2"	VDE-150-2-D202			1" - 1 1/2"	VRE-150-1-D205	-46C to 150C
	28"	VBO-250-1-U209			2" - 28"	VES-150-1-D210	-30C to 150C		1" - 2"	VDE-150-2-D203	-46C to 150C		2" - 28"	VRE-150-1-D114	0C to 150C
Butterfly	6"	VBO-150-2-D211	-46C to 150C	Ball	2" - 28"	VES-150-2-D110	-30C to 150C	Gate	2" - 28"	VGA-150-1-D201	-50C to 150C	Check	2" - 28"	VRE-150-1-D211	-46C to 150C
	6"	VBO-150-2-D212	-46C to 200C		2" - 28"	VES-150-2-D210	-46C to 150C		2" - 28"	VGA-150-2-D201	-50C to 150C		2" - 28"	VRE-150-1-D212	
	6"	VBO-150-2-D213	-46C to 200C		2" - 28"	VES-150-2-D230	-46C to 150C		Globe	2" - 18"	VGL-150-1-D201		-46C to 150C	2" - 28"	
	6"	VBO-150-3-D223	-46C to 150C		2" - 28"	VES-150-3-D217	-30C to 150C	2" - 18"		VGL-150-2-D101	-46C to 150C		2" - 28"	VRE-150-2-D215	
	6"	VBO-150-3-D226	0C to 150C		2" - 28"	VES-150-3-D226	0C to 150C	2" - 18"		VGL-150-2-D101	0C to 150C		2" - 28"	VRE-150-2-D235	



Branch (see notes)

Run Size	Branch Size	Component
1	1	TEE
1.5	1.5	RTEE, TEE
2	1.5, 2	RTEE, RTEE, TEE
3	1.5, 2, 3	WOL, RTEE, RTEE, TEE
4	1.5, 2, 3, 4	WOL, WOL, RTEE, RTEE, TEE
6	1.5, 2, 3, 4, 6	WOL, WOL, WOL, RTEE, RTEE, TEE
8	1.5, 2, 3, 4, 6, 8	WOL, WOL, WOL, WOL, RTEE, RTEE, TEE
10	1.5, 2, 3, 4, 6, 8, 10	WOL, WOL, WOL, WOL, WOL, RTEE, RTEE, TEE
12	1.5, 2, 3, 4, 6, 8, 10, 12	WOL, WOL, WOL, WOL, WOL, WOL, RTEE, RTEE, TEE
14	1.5, 2, 3, 4, 6, 8, 10, 12, 14	WOL, WOL, WOL, WOL, WOL, WOL, WOL, RTEE, RTEE, TEE
16	1.5, 2, 3, 4, 6, 8, 10, 12, 14, 16	WOL, WOL, WOL, WOL, WOL, WOL, WOL, WOL, RTEE, RTEE, TEE
18	1.5, 2, 3, 4, 6, 8, 10, 12, 14, 16, 18	WOL, WOL, WOL, WOL, WOL, WOL, WOL, WOL, WOL, RTEE, RTEE, TEE
20	1.5, 2, 3, 4, 6, 8, 10, 12, 14, 16, 18, 20	WOL, WOL, WOL, WOL, WOL, WOL, WOL, WOL, WOL, WOL, RTEE, RTEE, TEE
24	1.5, 2, 3, 4, 6, 8, 10, 12, 14, 16, 18, 20, 24	WOL, WOL, WOL, WOL, WOL, WOL, WOL, WOL, WOL, WOL, WOL, RTEE, RTEE, TEE
26	1.5, 2, 3, 4, 6, 8, 10, 12, 14, 16, 18, 20, 24, 26	WOL, WOL, WOL, WOL, WOL, WOL, WOL, WOL, WOL, WOL, WOL, WOL, RTEE, RTEE, TEE
28	1.5, 2, 3, 4, 6, 8, 10, 12, 14, 16, 18, 20, 24, 26, 28	WOL, WOL, WOL, WOL, WOL, WOL, WOL, WOL, WOL, WOL, WOL, WOL, WOL, RTEE, RTEE, TEE

- WOL - Weldolet
- TEE - Tee
- RTEE - Red Tee
- HC - Half Coupling
- SOC - Sockolet

Notes

1	On the spec valve list, it may have valves codes which contain values of process data lower than spec limits. It shall be verified all valve process data (e.g.: pressure, temperature) in order to specify it according the design premisses.
2	See Annex A for valves requirements and general selection criteria.
3	Bolts,nuts and gaskets (only RTJ gaskets) must be Zn-Ni coated according to Annex B.
4	See Annex C for instruments, drains and vents typical piping arrangement.
6	See Annex E for isolation gasket specifications.
7	Welding and Welding Inspection activities shall follow the requeriments of these documents: I-ET-3010.00-1200-955-P4X-001-Welding and I-ET-3010.00-1200-955-P4X-002-Requirements for Welding Inspection
50	Piping, fittings and accessories shall be organic coated internally acc. to I-ET-3010.00-1200-956-P4X-002 - General Painting.
54	This spec for PC service should only be used when recommended in annex D.
115	Gaskets shall not be be used to assembly butterfly valves API 609 category A, unless required required by the valve manufacturer.
125	Materials shall follow the requirements of IOGP S-563- Material Data Sheets for Piping and Valve Components. Coating for bolts and nuts shall follow spec note number 3.

 PETROBRAS		OFFSHORE PRODUCTION FACILITIES				Doc: I-ET-3010.1M-1200-200-P4X-001	Revision: F	Sheet 1 of 2
		PIPING SPECIFICATION FOR TOPSIDE					Issued by: SRGE/ESUP	Code: ASME B31.3

Services (see notes): F - Safety System and Flare; PC - Process (Corrosive Hydrocarbon); PCW - Produced water;	Material: Super Duplex	Class: 150	Standard: B12
--	----------------------------------	----------------------	-------------------------

Pressure Rating (see notes)										
Temperature (°C)	0	38	50	100	120	140				
Max Pressure (barg)	20	20	19.5	17.7	16.9	16.1				

Pipes and Fittings (see notes)

Items		Code	Size	Wall	Class	Ends	Standard	Material							
Pipes	Pipe	T-303	1/2" - 1 1/2" 2" - 8"	S-40S	-	PE	ASME B36.10/B36.19	ASTM A790 (UNS S32760) SML							
		T-304	10" - 24" 26" - 36"			BE		ASTM A928 (UNS S32760 Cl 1 or 3) WLD							
				0.375"											
Fittings	90 Elbow	C01-30	1/2" - 1 1/2"	-	3000	SW	ASME B16.11	ASTM A182 Gr F55 (UNS S32760)							
	45 Elbow	C02-30													
	Tee	C03-30													
	Cross	C05-30													
	Coupling	C06-30													
	Cap	C11-30													
	Socket	C55-30													
	Red Tee	C04-30	3/4" - 1 1/2"	-	-	-	-	-							
	Red Coupling	C08-30													
	Weldolet	C12-30	1"	According to pipe	-	-	-	-	-						
			2" - 16"												
	90 LR Elbow	C15-32	2" - 36"							-	-	-	-	-	-
	45 LR Elbow	C16-32													
	90 SR Elbow	C17-32													
	Tee	C20-32													
Cap	C22-32														
Cross	C24-32														
Conc. Red	C18-32														
Ecc. Red	C19-32	3" - 36"	-							-	-	-	-		
Red Tee	C21-32														
Nipple	Straight Nipple	N-S131	1/2" - 1 1/2"							According to pipe	-	-	-	-	
	Swage Conc Nipple	N-C132	3/4" - 1 1/2"												
		N-C432	2" - 4"												
	Swage Ecc Nipple	N-E132	3/4" - 1 1/2"												
N-E432		2" - 4"													
Flanges	Socket Weld (SW)	F-150-JH	1/2" - 1 1/2"	According to pipe	Class 150	Raised Face	-	-							
	Welding Neck (WN)	F-150-KH	2" - 24" 26" - 36"												
		F-150-LH	1/2" - 24" 26" - 36"												
	Blind	F-150-LH	1/2" - 24" 26" - 36"												
Bolts & Gasket Nuts	Spiral-Wound	J-150-EL	1/2" - 36"	-	Class 150	Raised Face	ASME B16.20	Duplex/graphite							
	Stud and Nuts	P-150-07	1/2" - 1 1/2"	-	-	-	ASME B1.1	A193 B7, Zn-Ni A194 Gr 2H, Zn-Ni							

		OFFSHORE PRODUCTION FACILITIES	Doc: I-ET-3010.1M-1200-200-P4X-001	Revision: F	Sheet: 2 of 2
		PIPING SPECIFICATION FOR TOPSIDE			Material: Super Duplex

Valves (see notes)

Type	Size	CODE	Temp	Type	Size	CODE	Temp	Type	Size	CODE	Temp	Type	Size	CODE	Temp							
Needle	½" - 1 ½"	VAG-3000-1-D302	-46C to 150C	Ball	½" - 1 ½"	VES-801-3-D305	0C to 150C	Ball	2" - 36"	VES-150-3-D353	0C to 150C	Gate	½" - 1 ½"	VGA-801-1-D301	-50C to 150C							
Butterfly	6" - 24"	VBO-150-2-D311	0C to 150C			VES-150-1-D310	-30C to 150C			VES-150-3-D372				Double Ball		½" - 2"	VDE-150-2-D301	-30C to 150C	Check	½" - 1 ½"	VRE-800-1-D302	-46C to 150C
		VBO-150-2-D313				VES-150-1-D330	0C to 150C			VES-150-3-D373							VDE-150-2-D302				VRE-150-2-D315	
Ball	10" - 32"	VBO-150-3-D323	-46C to 150C			VES-150-2-D310	-30C to 150C	VES-150-3-D317	-30C to 150C	VDE-150-2-D303	-46C to 150C	VRE-150-2-D335										
		VES-801-1-D301	0C to 150C			VES-150-2-D330	0C to 150C	VES-150-3-D337	0C to 150C	VDE-150-2-D304												
		VES-801-1-D305				VES-150-3-D352																
		VES-801-2-D301																				
		VES-801-2-D305																				



Branch (see notes)

Run Size	Branch Size	Material
0.5	0.5	TEE
0.75	0.75	RTEE
1	1	RTEE
1.5	1.5	RTEE
2	2	SOC
3	3	SOC
4	4	SOC
6	6	SOC
8	8	SOC
10	10	SOC
12	12	SOC
14	14	SOC
16	16	SOC
18	18	SOC
20	20	SOC
24	24	SOC
26	26	SOC
28	28	SOC
30	30	SOC
32	32	SOC
34	34	SOC
36	36	SOC

- WOL - Weldolet
- TEE - Tee
- RTEE - Red Tee
- HC - Half Coupling
- SOC - Sockolet

Notes

1	On the spec valve list, it may have valves codes which contain values of process data lower than spec limits. It shall be verified all valve process data (e.g.: pressure, temperature) in order to specify it according the design premisses.
2	See Annex A for valves requirements and general selection criteria.
3	Bolts, nuts and gaskets (only RTJ gaskets) must be Zn-Ni coated according to Annex B.
4	See Annex C for instruments, drains and vents typical piping arrangement.
5	Flanges ≤ 1 1/2" may be used, if strictly necessary.
6	See Annex E for isolation gasket specifications.
7	Welding and Welding Inspection activities shall follow the requirements of these documents: I-ET-3010.00-1200-955-P4X-001-Welding and I-ET-3010.00-1200-955-P4X-002-Requirements for Welding Inspection
8	All valves, pipes and components specified for hydrogen sulfide service shall be in accordance with ISO 15156 requirements.
26	See Annex A for valve casting qualification requirements.
48	SuperDuplex Stainless Steel external coating shall be applied for the temperature limits acc. to I-ET-3010.00-1200-956-P4X-002 - General Painting.
54	This spec for PC service should only be used when recommended in annex D.
57	All standardized pipe wall thickness herein listed are calculated considering only internal pressure. Other loads resulting of the piping analysis (supporting, flexibility, fatigue) may increase minimum required thickness.
120	Wafer valves are not to be used with flammable or combustible services, according to NFPA definition.
122	Inspection of pipe and piping components shall follow ASTM A923 requirements.
123	The application of this pipe specification for PCW - Produced Water is conditioned to maximum oxygen content 20 ppb and max temperature 120°C.
125	Materials shall follow the requirements of IOGP S-563- Material Data Sheets for Piping and Valve Components. Coating for bolts and nuts shall follow spec note number 3.

		OFFSHORE PRODUCTION FACILITIES				Doc: I-ET-3010.1M-1200-200- P4X-001	Revision: F	Sheet 1 of 2
		PIPING SPECIFICATION FOR TOPSIDE					Issued by: SRGE/ESUP	Code: ASME B31.3

Services (see notes): CN - Sodium Hypochlorite; IW - De-Aerated Sea Water Injection; IWC - Aerated Sea Water Injection; SW - Aerated Sea Water;	Material: Organic Coat CS	Class: 150	Standard: B14
--	---------------------------------	---------------	------------------

Pressure Rating (see notes)

Temperature (°C)	0	38	50	70							
Max Pressure (barg)	19.6	19.6	19.2	18.6							

Pipes and Fittings (see notes)

Items	Code	Size	Wall	Class	Ends	Standard	Material	
Pipes	Pipe	T-102	1" - 1 1/2"	XS	-	PE	ASME B36.10	API 5L Gr B PSL 1 SML
			2" - 6"	STD		BE		API 5L Gr B PSL 1 (SML or WLD HFW or WLD SAW)
			8" - 12"	S-20				API 5L Gr B PSL 1 WLD (HFW or SAW)
			14"	S-10				API 5L Gr B PSL 1 WLD SAW
			16" - 24"	0.250"				
			26" - 30"	0.281"				
			32"	S-10				
			34" - 36"	0.344"				
			38" - 40"	0.375"				
42" - 44"								
Fittings	Weldolet	C 12-02	1" - 20"	According to pipe	-	BE	MSS SP-97	ASTM A105
	90 LR Elbow	C 15-03	1" - 44"			-	ASME B16.9	ASTM A234 Gr WPB
	45 LR Elbow	C 16-03						
	90 SR Elbow	C 17-03						
	Tee	C 20-03						
	Cap	C 22-03						
	Cross	C 24-03						
	Conc. Red	C 18-03						
	Ecc. Red	C 19-03						
	Red Tee	C 21-03	1 1/2" - 44"					
Nipple	Swage Conc Nipple	N-C203	1 1/2" - 4"	According to pipe	-	BBE	MSS SP-95	ASTM A234 Gr WPB
	Swage Ecc Nipple	N-E203						
Flanges	Welding Neck (WN)	F-150-D2	1" - 24"	According to pipe	Class 150	Flat Face	ASME B16.5	ASTM A105
			26" - 44"				ASME B16.47 A	
	Blind	F-150-E2	1" - 24"				ASME B16.5	
			26" - 44"				ASME B16.47 A	
Gasket	Flat type	J-150-CC	1" - 44"	-	Class 150	Flat Face	ASME B16.21	Multidirectional Expanded PTFE
Bolts & Nuts	Stud and Nuts	P-150-07	1" - 1 1/2"	-	-	-	ASME B1.1	A193 B7, Zn-Ni
								A194 Gr 2H, Zn-Ni



PETROBRAS

NP-1

OFFSHORE PRODUCTION FACILITIES

Doc: I-ET-3010.1M-1200-200-P4X-001

Revision: F

Sheet: 2 of 2

PIPING SPECIFICATION FOR TOPSIDE

Material: Organic Coat CS

Class: 150

Standard: B14

Valves (see notes)



Table with 4 columns: Type, Size, CODE, Temp. Rows include Butterfly, Ball, Gate, and Globe valves with various specifications.

Branch (see notes)

Table showing combinations of Run Size and Branch Size for various fittings like Tee, Rtee, Wololet, etc.

Notes

- Notes 1-125 detailing valve specifications, materials, and assembly requirements.



		OFFSHORE PRODUCTION FACILITIES				Doc: I-ET-3010.1M-1200-200- P4X-001	Revision: F	Sheet 1 of 2
		PIPING SPECIFICATION FOR TOPSIDE					Issued by: SRGE/ESUP	Code: ASME B31.3

Services (see notes): AM - Amine; F - Safety System and Flare; PC - Process (Corrosive Hydrocarbon);	Material: Duplex	Class: 150	Standard: B16
---	---------------------	---------------	------------------

Pressure Rating (see notes)										
Temperature (°C)	-46	0	38	50	100	130				
Max Pressure (barg)	20	20	20	19.5	17.7	16.5				

Pipes and Fittings (see notes)

Items		Code	Size	Wall	Class	Ends	Standard	Material								
Pipes	Pipe	T-301	1/2" - 1 1/2" 2" - 8"	S-40S	-	PE	ASME B36.10/B36.19	ASTM A790 (UNS S31803) SML								
		T-302	10" - 24" 26" - 34"			BE		ASTM A928 (UNS S31803 Cl 1 or 3) WLD								
				0.375"												
Fittings	90 Elbow	C01-27	1/2" - 1 1/2"	-	3000	SW	ASME B16.11	ASTM A182 Gr F51 (UNS S31803)								
	45 Elbow	C02-27														
	Tee	C03-27														
	Cross	C05-27														
	Coupling	C06-27														
	Cap	C11-27														
	Socketlet	C55-27	3/4" - 1 1/2"	-	-	-	-	-								
	Red Tee	C04-27														
	Red Coupling	C08-27	2" - 16"	According to pipe	-	-	BE	ASME B16.11	ASTM A815 (UNS S31803)							
	Weldolet	C12-27														
	90 LR Elbow	C15-29														
	45 LR Elbow	C16-29														
	90 SR Elbow	C17-29														
	Tee	C20-29														
	Cap	C22-29														
	Cross	C24-29														
Conc. Red	C18-29															
Ecc. Red	C19-29															
Red Tee	C21-29															
Nipple	Straight Nipple	N-S128								1/2" - 1 1/2"	According to pipe	-	PBE	ASTM A733	ASTM A790 (UNS S31803)	
	Swage Conc Nipple	N-C129								3/4" - 1 1/2"				BLE x PSE	MSS SP-95	ASTM A815 (UNS S31803)
		N-C429								2" - 4"						
	Swage Ecc Nipple	N-E129	3/4" - 1 1/2"	2" - 4"	-	-	-	-								
		N-E429	2" - 4"													
Flanges	Socket Weld (SW)	F-150-JG	1/2" - 1 1/2"	According to pipe	Class 150	Raised Face	ASME B16.5	ASTM A182 Gr F51								
	Welding Neck (WN)	F-150-KG	2" - 24"				ASME B16.47 A									
			26" - 34"				ASME B16.5									
	Blind	F-150-LG	1/2" - 24" 26" - 34"				ASME B16.47 A									
Gasket	Spiral-Wound	J-150-EL	1/2" - 34"	-	Class 150	Raised Face	ASME B16.20	Duplex/graphite								
Bolts & Nuts	Stud and Nuts	P-150-07	1/2" - 1 1/4"	-	-	-	ASME B1.1	A193 B7, Zn-Ni								
								A194 Gr 2H, Zn-Ni								



		OFFSHORE PRODUCTION FACILITIES						Doc: I-ET-3010.1M-1200-200- P4X-001	Revision: F	Sheet 1 of 2
		PIPING SPECIFICATION FOR TOPSIDE						Issued by: SRGE/ESUP	Code: ASME B31.3	Corr. Allow. : 3.2 mm

Services (see notes): F - Safety System and Flare; FG - Fuel Gas; PC - Process (Corrosive Hydrocarbon);	Material: Low Temp CS	Class: 150	Standard: B19
--	-------------------------------------	----------------------	-------------------------

Pressure Rating (see notes)										
Temperature (°C)	-46	0	38	50	100	150	210			
Max Pressure (barg)	18.4	18.4	18.4	18.2	17.4	15.8	13.4			

Pipes and Fittings (see notes)

Items	Code	Size	Wall	Class	Ends	Standard	Material					
Pipes	T-105	1/2" - 1 1/2"	S-160	-	PE	ASME B36.10	ASTM A333 Gr 6 SML					
		2"	XS									
		3" - 6"	STD									
		8" - 12"	S-20									
		14"	S-10									
	16"											
	T-106	18" - 20"	0.281"		-		BE	ASME B36.10	ASTM A671 Gr CC60 Class 22 WLD			
		24"	0.312"									
		26"	S-10									
		28" - 30"	0.344"									
32" - 36"		STD										
Fittings	90 Elbow	C01-04	-	6000	SW	ASME B16.11	ASTM A350 Gr LF2 Cl 1					
	45 Elbow	C02-04										
	Tee	C03-04										
	Cross	C05-04										
	Coupling	C06-04										
	Cap	C11-04										
	Sockolet	C55-04										
	Red Tee	C04-04										
	Red Coupling	C08-04										
	Weldolet	C12-04						2" - 16"	According to pipe	-	ASME B16.11	ASTM A420 Gr WPL6
	90 LR Elbow	C15-05										
	45 LR Elbow	C16-05										
	90 SR Elbow	C17-05										
	Tee	C20-05										
	Cap	C22-05										
	Cross	C24-05										
	Conc. Red	C18-05										
Ecc. Red	C19-05											
Red Tee	C21-05											
Nipple	Straight Nipple	N-S137	1/2" - 1 1/2"	-	PBE	ASTM A733	ASTM A333 Gr 6					
	Swage Conc Nipple	N-C105	3/4" - 1 1/2"									
		N-C405	2" - 4"									
	Swage Ecc Nipple	N-E105	3/4" - 1 1/2"									
		N-E405	2" - 4"									
Flanges	Socket Weld (SW)	F-150-J3	1/2" - 1 1/2"	Class 150	Raised Face	ASME B16.5	ASTM A350 Gr LF2 Class 1					
	Welding Neck (WN)	F-150-K3	2" - 24"									
			26" - 36"									
	Blind	F-150-L3	1/2" - 24"									
26" - 36"												
Gasket	Spiral-Wound	J-150-EH	1/2" - 36"	-	Class 150	Raised Face	ASME B16.20	AISI 316/graphite				
	Bolts & Nuts	Stud and Nuts	P-150-07	1/2" - 1 1/2"	-	-	-	ASME B1.1	A193 B7, Zn-Ni			
								A194 Gr 2H, Zn-Ni				

		OFFSHORE PRODUCTION FACILITIES	Doc: I-ET-3010.1M-1200-200-P4X-001	Revision: F	Sheet 1 of 2
		PIPING SPECIFICATION FOR TOPSIDE			Issued by: SRGE/ESUP



Services (see notes): CHW - Chilled Water; CN - Sodium Hypochlorite; PW - Potable Water; W - Industrial water;	Material: PVC	Class: -	Standard: B20
---	------------------	-------------	------------------

Pressure Rating (see notes)

DN	0 to 23°C	30°C	35°C	40°C			DN	0 to 23°C	30°C	35°C	40°C			DN	0 to 23°C	30°C	35°C	40°C	
½"	58.5	43.8	36.3	29.2			2"	27.7	21	17.3	13.9			6"	19.3	14.4	11.9	9.6	
¾"	47.4	35.6	29.4	23.7			2 ½"	29.3	22	18.1	14.6			8"	17	12.7	10.5	8.5	
1"	43.4	32.6	26.9	21.7			3"	25.8	19.4	16.1	13								
1 ½"	32.5	24.3	20.1	16.2			4"	22.1	16.7	13.9	11.1								

Pipes and Fittings (see notes)

Items		Code	Size	Wall	Class	Ends	Standard	Material
Pipes	Pipe	T-401	½" - 8"	S-80	-	PE	ASTM D1785	PVC - ASTM D1785 class 1120 SML
	Fittings	Plug Cap Connector Union 45 Tee 90 Elbow 45 Elbow Tee Coupling Cap Red Tee Red. Bushing	C09-50 C11-50 C37-50 C10-50 C48-50 C01-50 C02-50 C03-50 C06-50 C11-50 C21-50 C56-50	½" - 2" ½" - 4" ½" - 6" ½" - 8" ¾" - 8"	- - According to pipe -	THD - Socket -	ASTM D2464 ASTM D2467 ASTM D2464 ASTM D2467	PVC - ASTM D1784 class 12454
Bolts & Gasket Flanges Nipples	Straight Nipple	N-S150	½" - 8"	According to pipe	-	PBE	ASTM D1785	PVC - ASTM D1785 class 1120
	Socket Weld (SW) Blind	F-150-CP F-150-EP	½" - 8"	According to pipe	Class 150	Flat Face	ASME B16.5	PVC - ASTM D1784 class 12454
	Flat type	J-150-CC	½" - 8"	-	Class 150	Flat Face	ASME B16.21	Multidirectional Expanded PTFE
Bolts & Nuts	Stud and Nuts	P-150-07	½" - ¾"	-	-	-	ASME B1.1	A193 B7, Zn-Ni A194 Gr 2H, Zn-Ni

		OFFSHORE PRODUCTION FACILITIES		Doc: I-ET-3010.1M-1200-200-P4X-001	Revision: F	Sheet: 2 of 2
		PIPING SPECIFICATION FOR TOPSIDE				Material: PVC

Valves (see notes)

Type	Size	CODE	Temp	Type	Size	CODE	Temp	Type	Size	CODE	Temp	Type	Size	CODE	Temp
Butterfly	2 1/2" - 8"	VBO-150-1-U401	10C to 40C	Ball	4" - 8"	VES-150-1-U403	10C to 70C	Ball	2" - 3"	VES-250-1-U403	10C to 70C	Check	1/2" - 6"	VRE-150-1-U401	10C to 40C
Ball	3" - 6"	VES-150-1-U401	10C to 40C		1/2" - 2"	VES-250-1-U401	10C to 40C		1" - 1 1/2"	VES-275-1-U403	10C to 70C				



Branch (see notes)

0.5	TEE								
0.75	RTEE TEE								
1	RTEE RTEE TEE								
1.5	RTEE RTEE RTEE TEE								
2	Note Note RTEE RTEE TEE								
2.5	Note Note Note RTEE RTEE TEE								
3	Note Note Note RTEE RTEE RTEE TEE								
4	Note Note Note Note RTEE RTEE RTEE TEE								
6	Note Note Note Note Note RTEE RTEE RTEE TEE								
8	Note Note Note Note Note Note RTEE RTEE RTEE TEE								
BRANCH SIZE									
0.5	0.75	1	1.5	2	2.5	3	4	6	8

WOL - Weldolet
TEE - Tee
RTEE - Red Tee
HC - Half Coupling
SOC - Sockolet

Notes

1	On the spec valve list, it may have valves codes which contain values of process data lower than spec limits. It shall be verified all valve process data (e.g.: pressure, temperature) in order to specify it according the design premisses.
2	See Annex A for valves requirements and general selection criteria.
3	Bolts,nuts and gaskets (only RTJ gaskets) must be Zn-Ni coated according to Annex B.
4	See Annex C for instruments, drains and vents typical piping arrangement.
36	Plain washers must be used to assembly flanged connections.
61	The pressure rating is reduced in 50%, in case of use threaded fittings.
75	The use of this spec is restricted to inside living quarter modules and out of classified areas.
90	FRP valves in this spec are indicated for isolation of the sodium hypochlorite generation unit.
105	Whenever non-metallics valves are used, the spec's pressure-temperature limits may be reduced according annex A (item A.7.6.2).
111	The flanges dimensions are according to ASME B16.5.
119	When not informed, header to branch connection shall be according to manufacturer recommendation.

		OFFSHORE PRODUCTION FACILITIES	Doc: I-ET-3010.1M-1200-200- P4X-001	Revision: F	Sheet 1 of 2
		PIPING SPECIFICATION FOR TOPSIDE		Issued by: SRGE/ESUP	Code: ASME B31.3

Services (see notes): HWU - Utility Heating Water; PWH - Hot Fresh Water;	Material: CPVC	Class: -	Standard: B21
--	-------------------	-------------	------------------

Pressure Rating (see notes)

DN	0 to 27°C	38°C	60°C	80°C			DN	0 to 27°C	38°C	60°C	80°C			DN	0 to 27°C	38°C	60°C	80°C		
½"	58.5	48	29.2	14.6			2"	27.8	22.8	13.9	7			6"	19.2	15.8	9.7	4.8		
¾"	47.4	38.9	23.7	11.9			2 ½"	29.3	24	14.6	7.3			8"	17	14	8.4	4.2		
1"	43.4	35.6	21.7	10.9			3"	25.8	21.2	13	6.5									
1 ½"	32.5	26.6	16.2	8.1			4"	22.3	18.3	11.2	5.6									

Pipes and Fittings (see notes)

Items		Code	Size	Wall	Class	Ends	Standard	Material
Pipes	Pipe	T-402	½" - 8"	S-80	-	PE	ASTM F441	CPVC - Chlorinated polyvinyl chloride, ASTM F441 4120 SML
	Fittings							
	Plug	C09-51	½" - 8"	-	-	THD	ASTM F439	CPVC - ASTM D1784 class 23447
	Cap	C11-51				½" - 2"		
	Connector	C37-51						
	Union	C10-51				½" - 4"		
	45 Tee	C48-51				½" - 6"		
	90 Elbow	C01-51						
	45 Elbow	C02-51						
	Tee	C03-51				½" - 8"		
	Coupling	C06-51						
	Cap	C11-51						
	Red Tee	C21-51	¾" - 8"	According to pipe				
	Red. Bushing	C56-51		-				
Nipple	Straight Nipple	N-S151	½" - 8"	According to pipe	-	PBE	ASTM F441	CPVC - ASTM F441 class 4120
Flanges	Socket Weld (SW)	F-150-CQ	½" - 8"	According to pipe	Class 150	Flat Face	ASME B16.5	CPVC-Chlorinated polyvinyl chloride, ASTM D1784 class 23447
	Blind	F-150-EQ	½" - 1"					
			1 ¼"					
			1 ½" - 8"					
Gasket	Flat type	J-150-CC	½" - 1"	-	Class 150	Flat Face	ASME B16.21	Multidirectional Expanded PTFE
			1 ¼"					
			1 ½" - 8"					
Bolts & Nuts	Stud and Nuts	P-150-07	½" - ¾"	-	-	-	ASME B1.1	A193 B7, Zn-Ni
								A194 Gr 2H, Zn-Ni



OFFSHORE PRODUCTION FACILITIES

Doc: I-ET-3010.1M-1200-200-P4X-001

Revision: F

Sheet: 2 of 2

PIPING SPECIFICATION FOR TOPSIDE

Material: CPVC

Class: -

Standard: B21

Valves (see notes)

Type	Size	CODE	Temp	Type	Size	CODE	Temp	Type	Size	CODE	Temp	Type	Size	CODE	Temp
Butterfly	2 1/2" - 8"	VBO-150-1-U402	10C to 80C	Ball	4" - 8"	VES-150-1-U403	10C to 70C	Ball	2" - 3"	VES-250-1-U403	10C to 70C	Check	1/2" - 1"	VRE-150-1-U402	10C to 80C
Ball	3" - 6"	VES-150-1-U402	10C to 80C		1/2" - 1"	VES-250-1-U402	10C to 80C		1"	VES-275-1-U403					



Branch (see notes)

0.5	TEE									
0.75	RTEE	TEE								
1	RTEE	RTEE	TEE							
1.5	RTEE	RTEE	RTEE	TEE						
2	Note	Note	RTEE	RTEE	TEE					
2.5	Note	Note	Note	RTEE	RTEE	TEE				
3	Note	Note	Note	RTEE	RTEE	RTEE	TEE			
4	Note	Note	Note	Note	RTEE	RTEE	RTEE	TEE		
6	Note	Note	Note	Note	Note	RTEE	RTEE	RTEE	TEE	
8	Note	Note	Note	Note	Note	Note	RTEE	RTEE	RTEE	TEE
0.5		0.75	1	1.5	2	2.5	3	4	6	8

WOL - Weldolet
 TEE - Tee
 RTEE - Red Tee
 HC - Half Coupling
 SOC - Sockolet

Notes

1	On the spec valve list, it may have valves codes which contain values of process data lower than spec limits. It shall be verified all valve process data (e.g.: pressure, temperature) in order to specify it according the design premisses.
2	See Annex A for valves requirements and general selection criteria.
3	Bolts,nuts and gaskets (only RTJ gaskets) must be Zn-Ni coated according to Annex B.
4	See Annex C for instruments, drains and vents typical piping arrangement.
36	Plain washers must be used to assembly flanged connections.
61	The pressure rating is reduced in 50%, in case of use threaded fittings.
75	The use of this spec is restricted to inside living quarter modules and out of classified areas.
105	Whenever non-metallics valves are used, the spec's pressure-temperature limits may be reduced according annex A (item A.7.6.2).
111	The flanges dimensions are according to ASME B16.5.
119	When not informed, header to branch connection shall be according to manufacturer recommendation.

		OFFSHORE PRODUCTION FACILITIES				Doc: I-ET-3010.1M-1200-200- P4X-001	Revision: F	Sheet 1 of 2
		PIPING SPECIFICATION FOR TOPSIDE					Issued by: SRGE/ESUP	Code: ASME B31.3

Services (see notes): DA - Open Drain; HWU - Utility Heating Water; IWC - Aerated Sea Water Injection; PWH - Hot Fresh Water; SW - Aerated Sea Water; W - Industrial water;					Material: FRP	Class: 10 bar	Standard: B22
--	--	--	--	--	------------------	------------------	------------------

Pressure Rating (see notes)									
Temperature (°C)	90								
Max Pressure (barg)	10								

Pipes and Fittings (see notes)								
	Items	Code	Size	Wall	Class	Ends	Standard	Material
Pipes	Pipe	T-404	1" - 40"	acc. manufact.	-	Butt-Strap Bell-Spigot	ISO 14692	FRP - Bisphenol A Epoxy resins reinforced with fiberglass type E or E-CR. Design pressure 10 bar@90°C. SML
	Fittings	Plug	C09-36	1" - 1 1/2"	-	250	THD	ASME B16.15
Thd Saddle		C52-52	1" - 6"	-		-	ISO 14692	FRP - Bisphenol A Epoxy resins reinforced with fiberglass type E or E-CR. Design pressure 10bar@90°C
Flg Saddle		C51-52		According to pipe		10 bar		
Coupling		C06-52	-					
90 LR Elbow		C15-52	Bell-Spigot					
45 LR Elbow		C16-52	Butt-Strap					
Tee		C20-52	Bell-Spigot					
FRP Conc. Red.		C61-52	Butt-Strap					
FRP Ecc. Red.		C62-52	Bell-Spigot					
Red Tee		C63-52	Butt-Strap					
Bolts & Gasket Flanges	Blind	F-10-ET	1" - 40"	According to pipe	10 bar	Flat Face		
	Integral Flange	F-10-1T						
Bolts & Nuts	Flat type	J-150-C3	1" - 40"	-	Class 150	Flat Face	ASME B16.21	Neoprene
	Stud and Nuts	P-150-07	1/2" - 1 1/2"	-	-	-	ASME B1.1	A193 B7, Zn-Ni A194 Gr 2H, Zn-Ni

Valves (see notes)



Type	Size	CODE	Temp	Type	Size	CODE	Temp	Type	Size	CODE	Temp	Type	Size	CODE	Temp
Butterfly	6" - 36"	VBO-150-1-U201	0C to 75C	Butterfly	6" - 24"	VBO-150-2-U314	0C to 90C	Gate	1" - 12"	VGA-150-2-U302	-46C to 75C	Ball	4" - 10"	VES-150-1-U403	10C to 70C
		VBO-150-1-U202				VBO-150-2-U316				VGL-150-1-U302				VES-250-1-U403	
	VBO-150-1-U203	VBO-150-3-U326	VGL-150-2-U302	VES-275-1-U403											
	VBO-150-2-U312	-46C to 75C	Gate	1" - 12"	VGA-150-1-U302	-46C to 75C	Check	2" - 24"	VRE-150-1-U314	0C to 75C					

Branch (see notes)

RUN SIZE	1	TEE																									
	1.5	RTEE	TEE																								
	2	RTEE	RTEE	TEE																							
	2.5	RTEE	RTEE	RTEE	TEE																						
	3	FSDL	FSDL	RTEE	RTEE	RTEE	TEE																				
	4	FSDL	FSDL	FSDL	RTEE	RTEE	RTEE	TEE																			
	6	FSDL	FSDL	FSDL	FSDL	RTEE	RTEE	RTEE	TEE																		
	8	FSDL	FSDL	FSDL	FSDL	FSDL	RTEE	RTEE	RTEE	TEE																	
	10	FSDL	FSDL	FSDL	FSDL	FSDL	FSDL	RTEE	RTEE	RTEE	TEE																
	12	FSDL	FSDL	FSDL	FSDL	FSDL	FSDL	RTEE	RTEE	RTEE	RTEE	TEE															
	14	FSDL	FSDL	FSDL	FSDL	FSDL	FSDL	FSDL	RTEE	RTEE	RTEE	RTEE	TEE														
	16	FSDL	FSDL	FSDL	FSDL	FSDL	FSDL	FSDL	RTEE	RTEE	RTEE	RTEE	RTEE	TEE													
	18	FSDL	FSDL	FSDL	FSDL	FSDL	FSDL	FSDL	RTEE	RTEE	RTEE	RTEE	RTEE	RTEE	TEE												
	20	FSDL	FSDL	FSDL	FSDL	FSDL	FSDL	FSDL	RTEE	RTEE	RTEE	RTEE	RTEE	RTEE	RTEE	TEE											
	24	FSDL	FSDL	FSDL	FSDL	FSDL	FSDL	FSDL	RTEE	RTEE	RTEE	RTEE	RTEE	RTEE	RTEE	RTEE	TEE										
	26	FSDL	FSDL	FSDL	FSDL	FSDL	FSDL	FSDL	RTEE	RTEE	RTEE	RTEE	RTEE	RTEE	RTEE	RTEE	RTEE	TEE									
	28	FSDL	FSDL	FSDL	FSDL	FSDL	FSDL	FSDL	RTEE	RTEE	RTEE	RTEE	RTEE	RTEE	RTEE	RTEE	RTEE	RTEE	TEE								
	30	FSDL	FSDL	FSDL	FSDL	FSDL	FSDL	FSDL	RTEE	RTEE	RTEE	RTEE	RTEE	RTEE	RTEE	RTEE	RTEE	RTEE	RTEE	TEE							
	32	FSDL	FSDL	FSDL	FSDL	FSDL	FSDL	FSDL	RTEE	RTEE	RTEE	RTEE	RTEE	RTEE	RTEE	RTEE	RTEE	RTEE	RTEE	RTEE	TEE						
	36	FSDL	FSDL	FSDL	FSDL	FSDL	FSDL	FSDL	RTEE	RTEE	RTEE	RTEE	RTEE	RTEE	RTEE	RTEE	RTEE	RTEE	RTEE	RTEE	RTEE	TEE					
	40	FSDL	FSDL	FSDL	FSDL	FSDL	FSDL	FSDL	RTEE	RTEE	RTEE	RTEE	RTEE	RTEE	RTEE	RTEE	RTEE	RTEE	RTEE	RTEE	RTEE	RTEE	TEE				
	BRANCH SIZE																										

Notes

1	On the spec valve list, it may have valves codes which contain values of process data lower than spec limits. It shall be verified all valve process data (e.g.: pressure, temperature) in order to specify it according the design premisses.
2	See Annex A for valves requirements and general selection criteria.
3	Bolts,nuts and gaskets (only RTJ gaskets) must be Zn-Ni coated according to Annex B.
4	See Annex C for instruments, drains and vents typical piping arrangement.
31	Electrical conductivity/resistivity shall be tested in accordance with ASTM D257. For components requiring electrical conductivity due to external charge generating mechanisms, the surface resistivity shall be 10 ⁴ 5 ohms or less. For components requiring electrical conductivity due to internal charge generating mechanisms, the volume resistivity shall be 10 ¹³ ohm-meter or less.
32	GRP piping and fittings must be certified according to level L3 IMO A753 fire endurance test.
33	GRP piping and fittings must be supplied with UV protection.
34	GRP piping and fittings must have Type Approval certified by Classification Societies.
35	Pipes and fittings must be supplied by the same manufacturer, that also shall be responsible for design, fabrication, assembly, inspection, test, repair and comissioning.
36	Plain washers must be used to assembly flanged connections.
37	See Annex H for Minimum Requirements for FRP pipes and fittings.
39	The bolt torque limit shall be informed by manufacturer.
74	Bell-spigot adhesived joint is allow able for all diameter in open drain (DA) service, but the maximum pressure shall be 4 bar.
105	Whenever non-metallics v alves are used, the spec's pressure-temperature limits may be reduced according annex A (item A.7.6.2).
112	For pipes and fittings may be used as alternative vinyl ester resins. See Annex H.
115	Gaskets shall not be used to assembly butterfly valves API 609 category A, unless required required by the valve manufacturer.

			OFFSHORE PRODUCTION FACILITIES					Doc:	Revision:	Sheet
								I-ET-3010.1M-1200-200-P4X-001	F	1 of 2
PIPING SPECIFICATION FOR TOPSIDE							Issued by:	Code:	Corr. Allow.:	
							SRGE/ESUP	ASME B31.3	-	
Services (see notes): ADW - Aerated Dilution Water; DA - Open Drain; HWU - Utility Heating Water; IW - De-Aerated Sea Water Injection; IWC - Aerated Sea Water Injection; PWH - Hot Fresh Water; SW - Aerated Sea Water; W - Industrial water;							Material:	Class:	Standard:	
							FRP	16 bar	B23	
Pressure Rating (see notes)										
Temperature (°C)	90									
Max Pressure (barg)	16									
Pipes and Fittings (see notes)										
	Items	Code	Size	Wall	Class	Ends	Standard	Material		
Pipes	Pipe	T-406	1" - 46"	acc. manufact.	-	Butt-Strap Bell-Spigot	ISO 14692	FRP - Bisphenol A Epoxy resins reinforced with fiberglass type E or E-CR. Design pressure 16 bar@90°C. SML		
	Plug	C09-36	1" - 1 1/2"	-	250	THD	ASME B16.15	ASTM B62 (UNS C83600)		
Fittings	Thd Saddle	C52-54	1" - 6"	-	-	-	ISO 14692	FRP - Bisphenol A Epoxy resins reinforced with fiberglass type E or E-CR. Design pressure 16bar@90°C		
	Flg Saddle	C51-54	1" - 6"	-	-	-				
	45 LR Elbow	C16-54	1" - 32"	According to pipe	16 bar	Bell-Spigot				
	FRP Stub End	C64-54		-		Butt-Strap				
	Coupling	C06-54	1" - 46"	According to pipe	16 bar	Bell-Spigot				
	90 LR Elbow	C15-54				-				Butt-Strap
	Tee	C20-54	2" - 46"	-	16 bar	Bell-Spigot				
	FRP Conc. Red.	C61-54				-				Butt-Strap
	FRP Ecc. Red.	C62-54	34"	According to pipe	16 bar	Bell-Spigot				
	Red Tee	C63-54				-				Butt-Strap
	45 LR Elbow	C16-54	36"	According to pipe	16 bar	Bell-Spigot				
	FRP Stub End	C64-54				-				Butt-Strap
	45 LR Elbow	C16-54	38"	According to pipe	16 bar	Bell-Spigot				
	FRP Stub End	C64-54				-				Butt-Strap
	45 LR Elbow	C16-54	40" - 44"	-	16 bar	Bell-Spigot				
	FRP Stub End	C64-54				-				Butt-Strap
45 LR Elbow	C16-54	40" - 46"	According to pipe	16 bar	Bell-Spigot					
Gasket Flanges	Blind	F-16-LT	1" - 46"	According to pipe	16 bar	Raised Face	ASTM D4024 - Drilling acc. B16.5/B16.47 CL150	FRP - Bisphenol A Epoxy resins reinforced with fiberglass type E or E-CR. Suitable for 90°C.		
	Backing Flange	F-16-YV	1" - 44"				Drilling acc. B16.5/B16.47 CL150	ASTM A105 Epoxy coated		
Bolts & Nuts	Flat type	J-150-P3	1" - 46"	-	Class 150	Raised Face	ASME B16.21	Neoprene		
	Stud and Nuts	P-150-07	1/2" - 1 1/2"	-	-	-	ASME B1.1	A193 B7, Zn-Ni A194 Gr 2H, Zn-Ni		

Valves (see notes)



Type	Size	CODE	Temp	Type	Size	CODE	Temp	Type	Size	CODE	Temp	Type	Size	CODE	Temp					
Butterfly	6" - 24"	VBO-250-1-U201	0C to 75C	Ball	1" - 1 1/2"	VES-150-1-U300	0C to 75C	Gate	1" - 12"	VGA-150-2-U302	-46C to 75C	Check	4" - 46"	VRE-150-2-U332	0C to 75C					
	28" - 44"	VBO-250-1-U203			1" - 1 1/2"	VES-150-2-U300			1" - 12"	VGL-150-1-U302			4" - 46"	VRE-150-2-U335						
	6" - 44"	VBO-150-2-U311	-46C to 75C		Gate	2" - 4"			VES-150-1-U310	0C to 75C	Globe		2" - 18"	VGL-150-2-U302	0C to 75C	Ball	4" - 6"	VES-150-1-U403	10C to 70C	
		VBO-150-2-U312				2" - 4"			VES-150-2-U310				1" - 1 1/2"	VGL-225-1-U101			2" - 3"	VES-250-1-U403		
		VBO-150-2-U313				0C to 90C			1" - 12"				VGA-150-1-U302	-46C to 75C			2" - 46"	VRE-150-1-U314		0C to 75C
		6" - 32"				VBO-150-3-U326			-29C to 75C											

Branch (see notes)

RUN SIZE	1	1.5	2	2.5	3	4	6	8	10	12	14	16	18	20	24	26	28	30	32	36	40	42	44	46		
	1	1.5																								
	1.5																									
	2	1.5																								
	2.5	1.5																								
	3	1.5	2																							
	4	1.5	2	2.5																						
	6	1.5	2	2.5	3																					
	8	1.5	2	2.5	3	4																				
	10	1.5	2	2.5	3	4	6																			
	12	1.5	2	2.5	3	4	6	8																		
	14	1.5	2	2.5	3	4	6	8	10																	
	16	1.5	2	2.5	3	4	6	8	10	12																
	18	1.5	2	2.5	3	4	6	8	10	12	14															
	20	1.5	2	2.5	3	4	6	8	10	12	14	16														
	24	1.5	2	2.5	3	4	6	8	10	12	14	16	18													
	26	1.5	2	2.5	3	4	6	8	10	12	14	16	18	20												
	28	1.5	2	2.5	3	4	6	8	10	12	14	16	18	20	24											
	30	1.5	2	2.5	3	4	6	8	10	12	14	16	18	20	24	26										
	32	1.5	2	2.5	3	4	6	8	10	12	14	16	18	20	24	26	28									
	36	1.5	2	2.5	3	4	6	8	10	12	14	16	18	20	24	26	28	30								
	40	1.5	2	2.5	3	4	6	8	10	12	14	16	18	20	24	26	28	30	32							
	42	1.5	2	2.5	3	4	6	8	10	12	14	16	18	20	24	26	28	30	32	36						
	44	1.5	2	2.5	3	4	6	8	10	12	14	16	18	20	24	26	28	30	32	36	40					
	46	1.5	2	2.5	3	4	6	8	10	12	14	16	18	20	24	26	28	30	32	36	40	42				

Notes

1	On the spec valve list, it may have valves codes which contain values of process data lower than spec limits. It shall be verified all valve process data (e.g.: pressure, temperature) in order to specify it according the design premisses.
2	See Annex A for valves requirements and general selection criteria.
3	Bolts,nuts and gaskets (only RTJ gaskets) must be Zn-Ni coated according to Annex B.
4	See Annex C for instruments, drains and vents typical piping arrangement.
31	Electrical conductivity/resistivity shall be tested in accordance with ASTM D257. For components requiring electrical conductivity due to external charge generating mechanisms, the surface resistivity shall be 10^5 ohms or less. For components requiring electrical conductivity due to internal charge generating mechanisms, the volume resistivity shall be 10^3 ohm-meter or less.
32	GRP piping and fittings must be certified according to level L3 IMO A753 fire endurance test.
33	GRP piping and fittings must be supplied with UV protection.
34	GRP piping and fittings must have Type Approval certified by Classification Societies.
35	Pipes and fittings must be supplied by the same manufacturer, that also shall be responsible for design, fabrication, assembly, inspection, test, repair and comissioning.
36	Plain washers must be used to assembly flanged connections.
37	See Annex H for Minimum Requirements for FRP pipes and fittings.
39	The bolt torque limit shall be informed by manufacturer.
105	Whenever non-metallics valves are used, the spec's pressure-temperature limits may be reduced according annex A (item A.7.6.2).
112	For pipes and fittings may be used as alternative vinyl ester resins. See Annex H.
115	Gaskets shall not be used to assembly butterfly valves API 609 category A, unless required required by the valve manufacturer.

		OFFSHORE PRODUCTION FACILITIES				Doc: I-ET-3010.1M-1200-200- P4X-001	Revision: F	Sheet 1 of 2
		PIPING SPECIFICATION FOR TOPSIDE					Issued by: SRGE/ESUP	Code: ASME B31.3

Services (see notes): PCW - Produced water;	Material: FRP	Class: 16 bar	Standard: B26
--	------------------	------------------	------------------

Pressure Rating (see notes)

Temperature (°C)	120									
Max Pressure (barg)	16									

Pipes and Fittings (see notes)

Items		Code	Size	Wall	Class	Ends	Standard	Material	
Pipes	Pipe	T-408	1" - 36"	acc. manufact.	-	Butt-Strap Bell-Spigot	ISO 14692	FRP - Bisphenol A Epoxy resins reinforced with fiberglass type E or E-CR. Design pressure 16 bar@120°C. SML	
	Plug	C09-36	1" - 1 1/2"	-	250	THD	ASME B16.15	ASTM B62 (UNS C83600)	
Fittings	Thd Saddle	C52-56	1" - 6"		-	-	ISO 14692	FRP - Bisphenol A Epoxy resins reinforced with fiberglass type E or E-CR. Design pressure 16bar@120°C	
	Flg Saddle	C51-56	1" - 6"		-	-			
	FRP Stub End	C64-56	1" - 32"		According to pipe	16 bar			Bell-Spigot
	Coupling	C06-56	1" - 36"						Butt-Strap
	90 LR Elbow	C15-56							Bell-Spigot
	45 LR Elbow	C16-56							-
	Tee	C20-56			-	Butt-Strap			
	FRP Conc. Red.	C61-56	Bell-Spigot						
	FRP Ecc. Red.	C62-56	Butt-Strap						
	Red Tee	C63-56	Bell-Spigot						
FRP Stub End	C64-56	34"	-	16 bar	Butt-Strap				
		36"			Bell-Spigot				
Blind	F-16-EU	1" - 36"	According to pipe	16 bar	Flat Face	ASTM D4024 - Drilling acc. B16.5/B16.47 CL150	FRP - Bisphenol A Epoxy resins reinforced with fiberglass type E or E-CR. Suitable for 120°C.		
					Backing Flange	F-16-YV		Raised Face	Drilling acc. B16.5/B16.47 CL150
Gasket/Flanges	Flat type	J-150-PC	1" - 36"	-	Class 150	Raised Face	ASME B16.21	Multidirectional Expanded PTFE	
Bolts & Nuts	Stud and Nuts	P-150-07	1/2" - 1"	-	-	-	ASME B1.1	A193 B7, Zn-Ni	



PETROBRAS

NP-1

OFFSHORE PRODUCTION FACILITIES

Doc: I-ET-3010.1M-1200-200-P4X-001

Revision: F

Sheet: 2 of 2

PIPING SPECIFICATION FOR TOPSIDE

Material: FRP

Class: 16 bar

Standard: B26

Valves (see notes)



Table with 16 columns: Type, Size, CODE, Temp, and then repeated for Gate, Globe, and Check valves.

Branch (see notes)

Table showing branch types like TEE, RTEE, FSDL, etc. across various run and branch sizes (1 to 40).

Notes

- Notes 1 through 105 providing technical specifications and requirements for valves and fittings.

		OFFSHORE PRODUCTION FACILITIES				Doc: I-ET-3010.1M-1200-200- P4X-001	Revision: F	Sheet 1 of 2
		PIPING SPECIFICATION FOR TOPSIDE					Issued by: SRGE/ESUP	Code: ASME B31.3



Services (see notes): C12 - DBNPA Biocide; CN - Sodium Hypochlorite;	Material: FRP	Class: 16 bar	Standard: B27
---	------------------	------------------	------------------

Pressure Rating (see notes)

Temperature (°C)	85										
Max Pressure (barg)	16										

Pipes and Fittings (see notes)

Items		Code	Size	Wall	Class	Ends	Standard	Material
Pipes	Pipe	T-409	1" - 6"	acc. manufact.	-	Bell-Spigot Butt-Strap	ISO 14692	FRP - Epoxy vinyl ester resins (bisphenol A brominated) reinforced with fiberglass type E-CR, inner liner with fiberglass veils type C. Design pressure 16 bar@85°C. SML
	Thd Saddle	C52-57	1" - 1 1/2"	-	-	-	ISO 14692	FRP - Epoxy vinyl ester resins (bisphenol A or brominated) reinforced with fiberglass type E-CR, inner liner with fiberglass veils type C. Design pressure 16 bar@85°C
Flg Saddle	C51-57	1" - 4"	-					
Coupling	C06-57	1" - 6"	According to pipe	Bell-Spigot				
90 LR Elbow	C15-57			-				
45 LR Elbow	C16-57			Butt-Strap				
Tee	C20-57			Bell-Spigot				
Red Tee	C63-57	2" - 3"	-	16 bar	Bell-Spigot			
FRP Conc. Red.	C61-57	2" - 6"		Butt-Strap				
FRP Ecc. Red.	C62-57			Bell-Spigot				
				Butt-Strap				
Gasket/Flanges	Blind	F-16-ES	1" - 6"	According to pipe	16 bar	Flat Face	ASTM D4024 - Drilling acc. B16.5/B16.47 CL150	FRP - Epoxy vinyl ester resins (bisphenol A or brominated) reinforced with fiberglass type E-CR. Suitable for 85°C.
	Integral Flange	F-16-1S						
Bolts & Nuts	Flat type	J-150-CC	1" - 6"	-	Class 150	Flat Face	ASME B16.21	Multidirectional Expanded PTFE
	Stud and Nuts	P-150-07	1/2" - 3/4"	-	-	-	ASME B1.1	A193 B7, Zn-Ni A194 Gr 2H, Zn-Ni

		OFFSHORE PRODUCTION FACILITIES				Doc: I-ET-3010.1M-1200-200-P4X-001	Revision: F	Sheet: 2 of 2
		PIPING SPECIFICATION FOR TOPSIDE						Material: FRP

Valves (see notes)

Type	Size	CODE	Temp	Type	Size	CODE	Temp	Type	Size	CODE	Temp	Type	Size	CODE	Temp
Needle	1" - 1 1/2"	VAG-150-1-D301	-50C to 150C	Ball	1" - 2"	VES-150-1-U600	0C to 70C	Check	1" - 1 1/2"	VRE-150-1-D305	-46C to 150C	Check	2"	VRE-150-1-U655	0C to 70C



Branch (see notes)

RUN SIZE	1	TEE	1.5	RTEE	TEE	2	RTEE	RTEE	TEE	2.5	RTEE	RTEE	RTEE	TEE	3	FSDL	RTEE	RTEE	RTEE	TEE	4	FSDL	FSDL	FSDL	FSDL	FSDL	TEE	6	FSDL	FSDL	FSDL	FSDL	FSDL	FSDL	TEE
	1	1.5	2	2.5	3	4	6	BRANCH SIZE																											

- WOL - Weldolet
- TEE - Tee
- RTEE - Red Tee
- HC - Half Coupling
- SOC - Sockolet
- FSDL - Flg Saddle
- TSDL - Thd Saddle

Notes

1	On the spec valve list, it may have valves codes which contain values of process data lower than spec limits. It shall be verified all valve process data (e.g.: pressure, temperature) in order to specify it according the design premisses.
2	See Annex A for valves requirements and general selection criteria.
3	Bolts,nuts and gaskets (only RTJ gaskets) must be Zn-Ni coated according to Annex B.
4	See Annex C for instruments, drains and vents typical piping arrangement.
31	Electrical conductivity/resistivity shall be tested in accordance with ASTM D257. For components requiring electrical conductivity due to external charge generating mechanisms, the surface resistivity shall be 10^5 ohms or less. For components requiring electrical conductivity due to internal charge generating mechanisms, the volume resistivity shall be 10^3 ohm-meter or less.
32	GRP piping and fittings must be certified according to level L3 IMO A753 fire endurance test.
33	GRP piping and fittings must be supplied with UV protection.
34	GRP piping and fittings must have Type Approval certified by Classification Societies.
35	Pipes and fittings must be supplied by the same manufacturer, that also shall be responsible for design, fabrication, assembly, inspection, test, repair and comissioning.
36	Plain washers must be used to assembly flanged connections.
37	See Annex H for Minimum Requirements for FRP pipes and fittings.
39	The bolt torque limit shall be informed by manufacturer.
66	It's not allowed to use overwrap joints (adhesive joint covered by fiber-resin layers).
105	Whenever non-metallics valves are used, the spec's pressure-temperature limits may be reduced according annex A (item A.7.6.2).

		OFFSHORE PRODUCTION FACILITIES						Doc: I-ET-3010.1M-1200-200- P4X-001	Revision: F	Sheet 1 of 2
		PIPING SPECIFICATION FOR TOPSIDE						Issued by: SRGE/ESUP	Code: ASME B31.3	Corr. Allow.: -

Services (see notes): F - Safety System and Flare; PC - Process (Corrosive Hydrocarbon);	Material: CS Inconel Clad.	Class: 150	Standard: B30
---	----------------------------------	---------------	------------------

Pressure Rating (see notes)										
Temperature (°C)	0	38	50	100	150	200	240			
Max Pressure (barg)	19.6	19.6	19.2	17.7	15.8	13.8	12.4			

Pipes and Fittings (see notes)

Items	Code	Size	Wall	Class	Ends	Standard	Material		
Pipes	T-203	1/2" - 1 1/2"	S-40S	-	PE	ASME B36.10/B36.19	ASTM B444 Gr 1 (UNS N06625) SML		
		2" - 3"							
		4" - 6"	STD						
		8" - 12"	S-20						
	T-102	14"	S-10		-	BE	ASME B36.10	API 5L Gr B PSL 1 (SML or WLD HFW or WLD SAW)	
		16" - 18"							
		20"							0.281"
		24"							0.312"
		26" - 28"	S-10			API 5L Gr B PSL 1 WLD (HFW or SAW)			
		30"	0.344"				API 5L Gr B PSL 1 WLD SAW		
Fittings	90 Elbow	C01-33	1/2" - 1 1/2"	-	3000	SW	ASME B16.11		
	45 Elbow	C02-33							
	Tee	C03-33							
	Cross	C05-33							
	Coupling	C06-33							
	Cap	C11-33							
	Socket	C55-33	3/4" - 1 1/2"	-	-	-	ASME B16.11		
	Red Tee	C04-33							
	Red Coupling	C08-33							
	Weldolet	C12-33	2" - 3"	-	-	-	ASME B16.9		
	90 LR Elbow	C15-33							
	45 LR Elbow	C16-33							
	90 SR Elbow	C17-33							
	Tee	C20-33							
	Cap	C22-33							
	Cross	C24-33	2" - 14"	-	-	-	MSS SP-97		
	Weldolet	C12-02							
	Conc. Red	C18-33							
	Ecc. Red	C19-33	3" - 4"	According to pipe	-	-	-	ASTM B366 (UNS N06625)	
	Red Tee	C21-33							
	90 LR Elbow	C15-03							
	45 LR Elbow	C16-03	4" - 30"	-	-	-	ASME B16.9	ASTM A234 Gr WPB	
	90 SR Elbow	C17-03							
	Tee	C20-03							
Cap	C22-03								
Cross	C24-03								
Conc. Red	C18-03								
Ecc. Red	C19-03	6" - 30"	-	-	-	-	-		
Red Tee	C21-03								
90 LR Elbow	C15-03								
Nipple	Straight Nipple	N-S139	1/2" - 1 1/2"	According to pipe	-	PBE	ASTM A733		
	Swage Conc Nipple	N-C133	3/4" - 1 1/2"						
	Swage Ecc Nipple	N-E133	3/4" - 1 1/2"						
		N-E433	2" - 4"						
Flanges	Socket Weld (SW)	F-150-JL	1/2" - 1 1/2"	According to pipe	Class 150	Raised Face	ASME B16.5		
	Welding Neck (WN)	F-150-KL	2" - 3"						
		F-150-KB	4" - 24"						
			26" - 30"						
	Blind	F-150-LL	1/2" - 3"						
		F-150-LB	4" - 24"						
26" - 30"									
Bolts & Gasket Nuts	Spiral-Wound	J-150-EM	1/2" - 30"	-	Class 150	Raised Face	ASME B16.20		
	Stud and Nuts	P-150-07	1/2" - 1 1/4"	-	-	-	ASME B1.1		



OFFSHORE PRODUCTION FACILITIES

Doc: I-ET-3010.1M-1200-200-P4X-001

Revision: F

Sheet: 2 of 2

PIPING SPECIFICATION FOR TOPSIDE

Material: CS Inconel Clad.

Class: 150

Standard: B30

Valves (see notes)

Table with 4 main columns for Valve Type (Needle, Ball), Size, CODE, and Temp. It lists various valve models like VAG-3000-1-N102, VES-150-1-C570, and VES-150-3-C526 with their respective temperature ranges.



Branch (see notes)

Branch size matrix showing combinations of Run Size (0.5 to 30) and Branch Size (0.5 to 30) with corresponding connection types like TEE, RTEE, and SOC.

- WOL - Weldolet
TEE - Tee
RTEE - Red Tee
HC - Half Coupling
SOC - Sockolet

Notes

- 1 On the spec valve list, it may have valves codes which contain values of process data lower than spec limits. It shall be verified all valve process data (e.g.: pressure, temperature) in order to specify it according the design premisses.
2 See Annex A for valves requirements and general selection criteria.
3 Bolts,nuts and gaskets (only RTJ gaskets) must be Zn-Ni coated according to Annex B.
4 See Annex C for instruments, drains and vents typical piping arrangement.
6 See Annex E for Isolation gasket specifications.
7 Welding and Welding Inspection activities shall follow the requeriments of these documents: I-ET-3010.00-1200-955-P4X-001-Welding and I-ET-3010.00-1200-955-P4X-002-Requirements for Welding Inspection
8 All valves, pipes and components specified for hydrogen sulfide service shall be in accordance with ISO 15156 requirements.
27 See Annex D to check the piping spec range application for H2S and CO2 service.
42 Piping, fittings and accessories shall have internal Inconel® 625 cladding according to I-ET-3010.00-1200-955-P4X-001 - Welding.
120 Wafer valves are not to be used with flammable or combustible services, according to NFPA definition.
125 Materials shall follow the requirements of IOGP S-563- Material Data Sheets for Piping and Valve Components. Coating for bolts and nuts shall follow spec note number 3.

		OFFSHORE PRODUCTION FACILITIES						Doc: I-ET-3010.1M-1200-200- P4X-001	Revision: F	Sheet 1 of 2
		PIPING SPECIFICATION FOR TOPSIDE						Issued by: SRGE/ESUP	Code: ASME B31.3	Corr. Allow. : -

Services (see notes): F - Safety System and Flare;	Material: SS 310H	Class: 150	Standard: B50
---	----------------------	---------------	------------------

Pressure Rating (see notes)

Temperature (°C)	38	100	200	300	400	500	538					
Max Pressure (barg)	19	16.6	13.8	10.2	6.5	2.8	1.4					

Pipes and Fittings (see notes)

Items		Code	Size	Wall	Class	Ends	Standard	Material	
Pipes	Pipe	T-321	1/2" - 1 1/2"	S-40S	-	PE	ASME B36.19	ASTM A312 TP 310H SML	
			2" - 24"			BE		ASTM A312 TP 310H WLD	
			26" - 46"						0.375"
			48"						0.406"
			52" - 56"						0.438"
Fittings	90 Elbow	C01-62	1/2" - 1 1/2"	-	3000	SW	ASME B16.11	ASTM A182 Gr F310H	
	45 Elbow	C02-62							
	Tee	C03-62							
	Cross	C05-62							
	Coupling	C06-62							
	Cap	C11-62							
	Socketlet	C55-62	3/4" - 1 1/2"	-	-	ASME B16.11	ASTM A403 Gr WP310H		
	Red Tee	C04-62							
	Red Coupling	C08-62							
	Weldolet	C12-62	2" - 24"	According to pipe	-	BE	ASME B16.9	ASTM A403 Gr WP310H	
	90 SR Elbow	C17-63							
	90 LR Elbow	C15-63							
	45 LR Elbow	C16-63							
	Tee	C20-63	2" - 48"	According to pipe	-	BE	ASME B16.9	ASTM A403 Gr WP310H	
	Cap	C22-63							
	Cross	C24-63							
	Conc. Red	C18-63							
	Ecc. Red	C19-63							
Red Tee	C21-63								
Red Tee	C21-63	3" - 48"							
Nipple	Straight Nipple	N-S141	1/2" - 1 1/2"	According to pipe	-	PBE	ASTM A733	ASTM A312 TP310H	
Flanges	Socket Weld (SW)	F-300-JW	1/2" - 1 1/2"	According to pipe	Class 300	Raised Face	ASME B16.5	ASTM A182 Gr F310H	
	Welding Neck (WN)	F-300-KW	2" - 24"				ASME B16.47 A		
			26" - 56"				ASME B16.5		
	Blind	F-300-LW	1/2" - 24"				ASME B16.47 A		
Gasket	Spiral-Wound	J-300-E2	1/2" - 56"	-	Class 300	Raised Face	ASME B16.20	AISI 316/MICA (high temp.)	
Bolts & Nuts	Stud and Nuts	P-300-10	1/2" - 1 3/4"	-	-	-	ASME B1.1	A453 660	



OFFSHORE PRODUCTION FACILITIES

Doc:
I-ET-3010.1M-1200-200-
P4X-001

Revision:
F

Sheet:
2 of 2

PIPING SPECIFICATION FOR TOPSIDE

Material:
SS 310H

Class:
150

Standard:
B50

Valves (see notes)

Type	Size	CODE	Temp	Type	Size	CODE	Temp	Type	Size	CODE	Temp	Type	Size	CODE	Temp
------	------	------	------	------	------	------	------	------	------	------	------	------	------	------	------

Branch (see notes)



WOL - Weldolet
TEE - Tee
RTEE - Red Tee
HC - Half Coupling
SOC - Sockolet

0.5	TEE																														
0.75	RTEE	TEE																													
1	RTEE	RTEE	TEE																												
1.5	RTEE	RTEE	RTEE	TEE																											
2	SOC	SOC	SOC	SOC	TEE																										
3	SOC	SOC	SOC	SOC	RTEE	TEE																									
4	SOC	SOC	SOC	SOC	RTEE	RTEE	TEE																								
6	SOC	SOC	SOC	SOC	WOL	RTEE	RTEE	TEE																							
8	SOC	SOC	SOC	SOC	WOL	WOL	RTEE	RTEE	TEE																						
10	SOC	SOC	SOC	SOC	WOL	WOL	WOL	RTEE	RTEE	TEE																					
12	SOC	SOC	SOC	SOC	WOL	WOL	WOL	RTEE	RTEE	RTEE	TEE																				
14	SOC	SOC	SOC	SOC	WOL	WOL	WOL	RTEE	RTEE	RTEE	RTEE	TEE																			
16	SOC	SOC	SOC	SOC	WOL	WOL	WOL	RTEE	RTEE	RTEE	RTEE	RTEE	TEE																		
18	SOC	SOC	SOC	SOC	WOL	WOL	WOL	WOL	RTEE	RTEE	RTEE	RTEE	RTEE	TEE																	
20	SOC	SOC	SOC	SOC	WOL	WOL	WOL	WOL	RTEE	RTEE	RTEE	RTEE	RTEE	RTEE	TEE																
24	SOC	SOC	SOC	SOC	WOL	WOL	WOL	WOL	WOL	RTEE	RTEE	RTEE	RTEE	RTEE	RTEE	TEE															
26	SOC	SOC	SOC	SOC	WOL	WOL	WOL	WOL	WOL	RTEE	RTEE	RTEE	RTEE	RTEE	RTEE	RTEE	TEE														
28	SOC	SOC	SOC	SOC	WOL	WOL	WOL	WOL	WOL	WOL	RTEE	RTEE	RTEE	RTEE	RTEE	RTEE	RTEE	TEE													
30	SOC	SOC	SOC	SOC	WOL	WOL	WOL	WOL	WOL	WOL	RTEE	RTEE	RTEE	RTEE	RTEE	RTEE	RTEE	RTEE	TEE												
32	SOC	SOC	SOC	SOC	WOL	WOL	WOL	WOL	WOL	WOL	RTEE	RTEE	RTEE	RTEE	RTEE	RTEE	RTEE	RTEE	RTEE	TEE											
34	SOC	SOC	SOC	SOC	WOL	WOL	WOL	WOL	WOL	WOL	WOL	RTEE	RTEE	RTEE	RTEE	RTEE	RTEE	RTEE	RTEE	RTEE	TEE										
36	SOC	SOC	SOC	SOC	WOL	WOL	WOL	WOL	WOL	WOL	WOL	RTEE	RTEE	RTEE	RTEE	RTEE	RTEE	RTEE	RTEE	RTEE	RTEE	TEE									
38	SOC	SOC	SOC	SOC	WOL	WOL	WOL	WOL	WOL	WOL	WOL	RTEE	RTEE	RTEE	RTEE	RTEE	RTEE	RTEE	RTEE	RTEE	RTEE	RTEE	TEE								
40	SOC	SOC	SOC	SOC	WOL	WOL	WOL	WOL	WOL	WOL	WOL	RTEE	RTEE	RTEE	RTEE	RTEE	RTEE	RTEE	RTEE	RTEE	RTEE	RTEE	RTEE	TEE							
42	SOC	SOC	SOC	SOC	WOL	WOL	WOL	WOL	WOL	WOL	WOL	RTEE	RTEE	RTEE	RTEE	RTEE	RTEE	RTEE	RTEE	RTEE	RTEE	RTEE	RTEE	RTEE	TEE						
44	SOC	SOC	SOC	SOC	WOL	WOL	WOL	WOL	WOL	WOL	WOL	RTEE	RTEE	RTEE	RTEE	RTEE	RTEE	RTEE	RTEE	RTEE	RTEE	RTEE	RTEE	RTEE	RTEE	TEE					
46	SOC	SOC	SOC	SOC	WOL	WOL	WOL	WOL	WOL	WOL	WOL	RTEE	RTEE	RTEE	RTEE	RTEE	RTEE	RTEE	RTEE	RTEE	RTEE	RTEE	RTEE	RTEE	RTEE	RTEE	TEE				
48	SOC	SOC	SOC	SOC	WOL	WOL	WOL	WOL	WOL	WOL	WOL	RTEE	RTEE	RTEE	RTEE	RTEE	RTEE	RTEE	RTEE	RTEE	RTEE	RTEE	RTEE	RTEE	RTEE	RTEE	RTEE	TEE			
52	SOC	SOC	SOC	SOC	WOL	WOL	WOL	WOL	WOL	WOL	WOL	WOL	RTEE	RTEE	RTEE	RTEE	RTEE	RTEE	RTEE	RTEE	RTEE	RTEE	RTEE	RTEE	RTEE	RTEE	RTEE	RTEE	TEE		
54	SOC	SOC	SOC	SOC	WOL	WOL	WOL	WOL	WOL	WOL	WOL	WOL	WOL	RTEE	RTEE	RTEE	RTEE	RTEE	RTEE	RTEE	RTEE	RTEE	RTEE	RTEE	RTEE	RTEE	RTEE	RTEE	RTEE	TEE	
56	SOC	SOC	SOC	SOC	WOL	WOL	WOL	WOL	WOL	WOL	WOL	WOL	WOL	WOL	RTEE	RTEE	RTEE	RTEE	RTEE	RTEE	RTEE	RTEE	RTEE	RTEE	RTEE	RTEE	RTEE	RTEE	RTEE	RTEE	TEE

BRANCH SIZE

Notes

3	Bolts,nuts and gaskets (only RTJ gaskets) must be Zn-Ni coated according to Annex B.
4	See Annex C for instruments, drains and vents typical piping arrangement.
7	Welding and Welding Inspection activities shall follow the requirements of these documents: I-ET-3010.00-1200-955-P4X-001-Welding and I-ET-3010.00-1200-955-P4X-002-Requirements for Welding Inspection
51	For temperatures above 60°C, stainless steels shall be coated acc. to I-ET-3010.00-1200-956-P4X-002 - General Painting.
117	The flange assembly shall be done with two nuts and one washer per bolt side. Circular washer shall be according to ASTM F436.
118	The spec is limited for application above flare service platform.
125	Materials shall follow the requirements of IOGP S-563- Material Data Sheets for Piping and Valve Components. Coating for bolts and nuts shall follow spec note number 3.

		OFFSHORE PRODUCTION FACILITIES				Doc: I-ET-3010.1M-1200-200- P4X-001	Revision: F	Sheet 1 of 2
		PIPING SPECIFICATION FOR TOPSIDE					Issued by: SRGE/ESUP	Code: ASME B31.3

Services (see notes): CNI - Corrosive Chemical Injection (Except Sodium Hypochlorite); D - Diesel; F - Safety System and Flare; FG - Fuel Gas; G - Glycol; H - Hydraulic Fluid; PC - Process (Corrosive Hydrocarbon);					Material: SS 316/316L	Class: 300	Standard: C3
--	--	--	--	--	-----------------------------	---------------	-----------------

Pressure Rating (see notes)										
Temperature (°C)	-100	38	50	100	150					
Max Pressure (barg)	49.6	49.6	48.1	42.2	38.5					

Pipes and Fittings (see notes)

Items		Code	Size	Wall	Class	Ends	Standard	Material				
Pipes	Pipe	T-322	1/2" - 1 1/2"	S-40S	-	PE	ASME B36.19	ASTM A312 TP 316/316L SML				
		T-323	2" - 20"			BE	ASME B36.10/B36.19	ASTM A358 Type 316/316L Cl 1 or 3 WLD				
			24"	S-80S								
			26"	0.500"								
		28" - 30"	0.562"									
Fittings	90 Elbow	C01-43	1/2" - 1 1/2"	-	3000	SW	ASME B16.11	ASTM A182 Gr F316/316L				
	45 Elbow	C02-43										
	Tee	C03-43										
	Cross	C05-43										
	Coupling	C06-43										
	Cap	C11-43										
	Socket	C55-43	3/4" - 1 1/2"	-	-	ASME B16.11	-					
	Red Tee	C04-43										
	Red Coupling	C08-43										
	Weldolet	C12-43	2" - 14"	According to pipe	-	BE	MSS SP-97	ASTM A403 Gr WP316/316L				
	90 LR Elbow	C15-44	2" - 30"				-		BE	ASME B16.9		
	45 LR Elbow	C16-44										
	90 SR Elbow	C17-44										
	Tee	C20-44										
	Cap	C22-44										
	Cross	C24-44										
	Conc. Red	C18-44	3" - 30"				-		-	-		
	Ecc. Red	C19-44										
Red Tee	C21-44											
Nipple	Straight Nipple	N-S145	1" - 1 1/2"				According to pipe		-	PBE	ASTM A733	ASTM A312 TP316/316L
	Swage Conc Nipple	N-C144	3/4" - 1 1/2"							BLE x PSE	MSS SP-95	ASTM A403 Gr WP316/316L
		N-C444	2" - 4"									
	Swage Ecc Nipple	N-E144	3/4" - 1 1/2"	2" - 4"	BLE x PSE	-		-				
N-E444		2" - 4"										
Flanges	Socket Weld (SW)	F-300-JX	1/2" - 1 1/2"	According to pipe	Class 300	Raised Face	ASME B16.5	ASTM A182 Gr F316/316L				
	Welding Neck (WN)	F-300-KX	2" - 24"			-	-		ASME B16.47 A			
			26" - 30"						ISO 6162-1			
	Blind	F-350-4X	1/2" - 3"			max 350 bar	-		-	ASME B16.5		
			1/2" - 24"							ASME B16.47 A		
		F-300-LX	26" - 30"			max 350 bar	-		-	ISO 6162-1		
Hyd One-Piece Flange	F-350-3X	1/2" - 3"										
Bolts & Gasket Nuts	Spiral-Wound	J-300-EH	1/2" - 30"	-	Class 300	Raised Face	ASME B16.20	AISI 316/graphite				
	Stud and Nuts	P-300-08	1/2" - 1 1/2"	-	-	-	ASME B1.1	A320 L7, Zn-Ni A194 7L, Zn-Ni				



OFFSHORE PRODUCTION FACILITIES

Doc:
I-ET-3010.1M-1200-200-P4X-001

Revision:
F

Sheet:
2 of 2

PIPING SPECIFICATION FOR TOPSIDE

Material:
SS
316/316L

Class:
300

Standard:
C3

Valves (see notes)

Type	Size	CODE	Temp	Type	Size	CODE	Temp	Type	Size	CODE	Temp	Type	Size	CODE	Temp				
Needle	½" - 1 ½"	VAG-3000-1-S201	-100C to 200C	Ball	2" - 30"	VES-300-1-S230	-46C to 150C	Ball	2" - 30"	VES-300-3-S237	-46C to 150C	Double Ball	½" - 2"	VDE-300-2-S207	-100C to 340C				
		VAG-3000-2-S202	-100C to 400C			VES-300-2-S210	-30C to 150C			VES-300-3-S252	-30C to 150C			VDE-300-2-S208	-100C to 340C				
Butterfly	6" - 30"	VBO-300-2-S213	-46C to 150C			VES-300-2-S216	-30C to 150C			VES-300-3-S253	-30C to 150C	Gate	½" - 1 ½"	VGA-801-1-S201	-46C to 400C	Globe	2" - 18"	VGL-300-1-S201	-29C to 400C
		VBO-300-2-S216	-100C to 150C			VES-300-2-S220	0C to 150C			VES-300-3-S262	0C to 210C			VGA-300-1-S201	-46C to 400C			VGL-300-2-S201	-46C to 400C
Ball	½" - 1 ½"	VES-801-1-S201	-30C to 150C			VES-300-2-S226	0C to 150C			VES-300-3-S272	-100C to 200C	Plug	2" - 24"	VMA-300-2-S201	-30C to 93C	Check	½" - 1 ½"	VRE-800-1-S202	-100C to 400C
		VES-801-1-S202	-46C to 150C			VES-300-2-S230	-46C to 150C			VDE-300-2-S201	-30C to 150C			VRE-800-2-S202	-100C to 400C				
		VES-801-1-S205	-100C to 200C			VES-300-2-S236	-46C to 150C	VDE-300-2-S202	-30C to 150C	Check	2" - 30"			VRE-300-1-S211	0C to 150C				
		VES-801-2-S201	-30C to 150C			VES-300-2-S270	-100C to 200C	VDE-300-2-S203	-100C to 150C					VRE-300-2-S212	-46C to 150C				
		VES-801-2-S202	-46C to 150C			VES-300-3-S216	-30C to 150C	VDE-300-2-S204	-100C to 150C	VRE-300-2-S215	-46C to 150C								
		VES-801-2-S205	-100C to 200C			VES-300-3-S217	-30C to 150C	VDE-300-2-S205	-100C to 200C										
		VES-801-3-S205	-100C to 200C			VES-300-3-S226	0C to 150C	VDE-300-2-S206	-100C to 200C										
		2" - 30"	VES-300-1-S210			-30C to 150C	VES-300-3-S227	0C to 150C											
	VES-300-1-S220	0C to 150C	VES-300-3-S236	-46C to 150C															

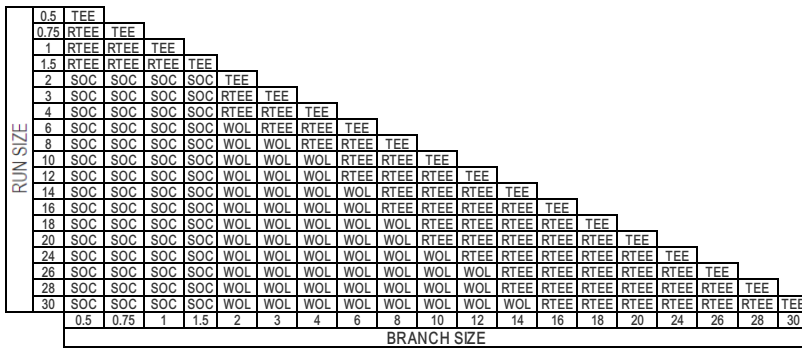

Branch (see notes)



WOL - Weldolet
TEE - Tee
RTEE - Red Tee
HC - Half Coupling
SOC - Socket

Notes

1	On the spec valve list, it may have valves codes which contain values of process data lower than spec limits. It shall be verified all valve process data (e.g.: pressure, temperature) in order to specify it according the design premisses.
2	See Annex A for valves requirements and general selection criteria.
3	Bolts,nuts and gaskets (only RTJ gaskets) must be Zn-Ni coated according to Annex B.
4	See Annex C for instruments, drains and vents typical piping arrangement.
5	Flanges ≤ 1 1/2" may be used, if strictly necessary .
6	See Annex E for Isolation gasket specifications.
7	Welding and Welding Inspection activities shall follow the requeriments of these documents: I-ET-3010.00-1200-955-P4X-001-Welding and I-ET-3010.00-1200-955-P4X-002-Requirements for Welding Inspection
51	Stainless Steel external coating shall be applied for the temperature limits acc. to I-ET-3010.00-1200-956-P4X-002 - General Painting.
55	This spec for FG service is applicable for piping downstream the fillers.
67	Branches with diameter greater than or equal to half the nominal diameter of the pipe shall be fitted with guide bars according to I-ET-3010.00-1200-295-P4X-001- Requirements for Pig L/R Design
68	This Spec shall be applied for distribution system of CO2, after directional valves.
120	Wafer valves are not to be used with flammable or combustible services, according to NFPA definition.
125	Materials shall follow the requirements of IOGP S-563- Material Data Sheets for Piping and Valve Components. Coating for bolts and nuts shall follow spec note number 3.
127	ISO 6162-1/2 flanges may be used only for H - Hydraulic Fluid.

		OFFSHORE PRODUCTION FACILITIES				Doc: I-ET-3010.1M-1200-200- P4X-001	Revision: F	Sheet 1 of 2
		PIPING SPECIFICATION FOR TOPSIDE					Issued by: SRGE/ESUP	Code: ASME B31.3
Services (see notes): HF - Hot Fluid; HWP - Process Heating Water; S - Steam; SC - Steam Condensate;						Material: Carbon Steel	Class: 300	Standard: C4

Pressure Rating (see notes)

Temperature (°C)	0	38	50	100	150	200	250	300	350			
Max Pressure (barg)	51.1	51.1	50.1	46.6	45.1	43.8	41.9	39.8	37.6			

Pipes and Fittings (see notes)

Items		Code	Size	Wall	Class	Ends	Standard	Material					
Pipes	Pipe	T-102	1/2" - 1 1/2"	XS	-	PE	ASME B36.10	API 5L Gr B PSL 1 SML					
			2" - 6"	STD		BE		ASME B36.10	API 5L Gr B PSL 1 (SML or WLD HFW or WLD SAW)				
			8"	S-30									
			10" - 12"	STD									
			14"	S-40									
			16" - 18"	XS									
			20"	0.562"		API 5L Gr B PSL 1 WLD (HFW or SAW)							
24"	S-40												
Fittings	90 Elbow	C01-02	1/2" - 1 1/2"	-	3000	SW	ASME B16.11	ASTM A105					
	45 Elbow	C02-02											
	Tee	C03-02											
	Cross	C05-02											
	Coupling	C06-02											
	Cap	C11-02											
	Socket	C55-02											
	Red Tee	C04-02	3/4" - 1 1/2"	-	3000	SW	ASME B16.11	ASTM A105					
	Red Coupling	C08-02											
	Weldolet	C12-02	1" - 10"	According to pipe	-	BE	ASME B16.9	ASTM A234 Gr WPB					
	90 LR Elbow	C15-03	2" - 24"										
	45 LR Elbow	C16-03											
	90 SR Elbow	C17-03											
	Tee	C20-03											
	Cap	C22-03											
	Cross	C24-03											
	Conc. Red	C18-03											
Ecc. Red	C19-03	3" - 24"											
Red Tee	C21-03												
Nipple	Straight Nipple	N-S120	1/2" - 1 1/2"						According to pipe	-	PBE	ASTM A733	API 5L Gr B PSL 1 seamless
	Swage Conc Nipple	N-C103	3/4" - 1 1/2"								BLE x PSE	MSS SP-95	ASTM A234 Gr WPB
	Swage Ecc Nipple	N-E103	3/4" - 1 1/2"										
		N-E403	2" - 4"										
Gasket/Flanges	Socket Weld (SW)	F-300-J2	1/2" - 1 1/2"	According to pipe	Class 300	Raised Face	ASME B16.5	ASTM A105					
	Welding Neck (WN)	F-300-K2	2" - 24"										
	Blind	F-300-L2	1/2" - 24"										
Gasket	Spiral-Wound	J-300-EH	1/2" - 24"	-	Class 300	Raised Face	ASME B16.20	AISI 316/graphite					
	Bolts & Nuts	Stud and Nuts	P-300-01	1/2" - 1 1/2"	-	-	-	ASME B1.1					
A193 B7													
A194 Gr 2H													



NP-1

OFFSHORE PRODUCTION FACILITIES

Doc: I-ET-3010.1M-1200-200-P4X-001

Revision: F

Sheet: 2 of 2

PIPING SPECIFICATION FOR TOPSIDE

Material: Carbon Steel

Class: 300

Standard: C4

Valves (see notes)

Table with columns: Type, Size, CODE, Temp. Rows include Needle, Butterfly, Ball, Gate, and Check valves with their respective specifications.



Branch (see notes)

Branch size matrix table showing combinations of Run Size and Branch Size for various connection types like Tee, Red Tee, Half Coupling, and Sockolet.

Legend for connection types: WOL - Weldolet, TEE - Tee, RTEE - Red Tee, HC - Half Coupling, SOC - Sockolet

Notes

- Notes 1 through 125 providing technical details and requirements for valves and materials.



		OFFSHORE PRODUCTION FACILITIES				Doc: I-ET-3010.1M-1200-200- P4X-001	Revision: F	Sheet 1 of 2
		PIPING SPECIFICATION FOR TOPSIDE					Issued by: SRGE/ESUP	Code: ASME B31.3

Services (see notes): F - Safety System and Flare; G - Glycol; GL - Refrigerated Liquefied Petroleum Gases in Low Temperature; P - Process (non-corrosive hydrocarbon);	Material: Low Temp CS	Class: 300	Standard: C6
--	-----------------------------	---------------	-----------------

Pressure Rating (see notes)										
Temperature (°C)	-46	0	38	50	100	110				
Max Pressure (barg)	48	48	48	47.5	45.3	45				

Pipes and Fittings (see notes)

Items		Code	Size	Wall	Class	Ends	Standard	Material			
Pipes	Pipe	T-105	1/2" - 1 1/2"	S-160	-	PE	ASME B36.10	ASTM A333 Gr 6 SML			
			2" - 6"	STD		BE					
			8"	S-20							
			10" - 12"	S-30							
			14"	STD							
		16"	STD								
		T-106	18"	0.406"		-			ASME B36.10	ASTM A671 Gr CC60 Class 22 WLD	
			20"	0.438"							
			24"	XS							
			Fittings								90 Elbow
45 Elbow			C02-04								
Tee		C03-04									
Cross		C05-04									
Coupling		C06-04									
Cap		C11-04									
Sockolet		C55-04									
Red Tee		C04-04									
Red Coupling		C08-04									
Weldolet		C12-04									
90 LR Elbow		C15-05	According to pipe	-	BE	ASME B16.11	ASTM A420 Gr WPL6				
45 LR Elbow		C16-05			-						
90 SR Elbow		C17-05									
Tee		C20-05									
Cap		C22-05									
Cross		C24-05									
Conc. Red		C18-05			3" - 24"			-	BE	ASME B16.9	
Ecc. Red		C19-05									
Red Tee		C21-05									
Nipple	Straight Nipple	N-S137			1/2" - 1 1/2"			According to pipe	-	PBE	ASTM A733
	Swage Conc Nipple	N-C105	3/4" - 1 1/2"	BLE x PSE	MSS SP-95	ASTM A420 Gr WPL6					
		N-C405	2" - 4"								
	Swage Ecc Nipple	N-E105	3/4" - 1 1/2"	2" - 4"	PBE	ASTM A420 Gr WPL6					
N-E405		2" - 4"									
Socket Weld (SW)	Socket Weld (SW)	F-300-J3	1/2" - 1 1/2"	According to pipe	Class 300	Raised Face	ASME B16.5	ASTM A350 Gr LF2 Class 1			
	Welding Neck (WN)	F-300-K3	2" - 24"								
	Blind	F-300-L3	1/2" - 24"								
Gasket/Flanges	Spiral-Wound	J-300-EH	1/2" - 24"	-	Class 300	Raised Face	ASME B16.20	AISI 316/graphite			
Bolts & Nuts	Stud and Nuts	P-300-07	1/2" - 1 1/2"	-	-	-	ASME B1.1	A193 B7, Zn-Ni			
								A194 Gr 2H, Zn-Ni			

 PETROBRAS		OFFSHORE PRODUCTION FACILITIES	Doc: I-ET-3010.1M-1200-200-P4X-001	Revision: F	Sheet: 2 of 2
		PIPING SPECIFICATION FOR TOPSIDE		Material: Low Temp CS	Class: 300

Valves (see notes)

Type	Size	CODE	Temp	Type	Size	CODE	Temp	Type	Size	CODE	Temp	Type	Size	CODE	Temp			
Needle	½" - 1 ½"	VAG-3000-1-S201	-100C to 200C	Ball	2" - 24"	VES-300-1-C230	-46C to 150C	Ball	2" - 24"	VES-300-3-C252	-30C to 150C	Globe	2" - 18"	VGL-300-1-C201	-46C to 345C			
		VAG-3000-1-S202	-100C to 400C			VES-300-2-C210	-30C to 150C			VES-300-3-C253				VGL-300-2-C201				
Butterfly	10" - 24"	VBO-300-3-C223	-46C to 240C			VES-300-2-C216	-30C to 150C	Double Ball	½" - 2"	Check	2" - 24"	VES-300-3-C272	-46C to 200C	Plug	2" - 24"	VMA-300-2-C201	-30C to 93C	
		VES-803-1-C201	-30C to 150C			VES-300-2-C230	-46C to 150C					VES-300-3-C273	VRE-800-1-C202			-46C to 345C		
Ball	½" - 1 ½"	VES-803-1-C205	-30C to 200C			VES-300-2-C236	-46C to 150C	VDE-300-2-C201	-30C to 150C	VDE-300-2-C202	-30C to 150C	VDE-300-2-C205	-46C to 200C	VDE-300-2-C206	-46C to 200C	VRE-800-2-C202	-46C to 345C	
		VES-803-2-C201	-30C to 150C			VES-300-3-C216	-30C to 150C										VRE-300-1-C211	0C to 150C
		VES-803-2-C205	-46C to 200C			VES-300-3-C217	-30C to 150C										VRE-300-2-C212	-46C to 345C
		VES-803-3-C205	-30C to 200C			VES-300-3-C236	-46C to 150C	VDE-300-2-C215	-30C to 150C	VRE-300-2-C215	-46C to 345C	VRE-300-2-C235	-46C to 210C					
		VES-300-1-C210	-30C to 150C			VES-300-3-C237	-46C to 150C											



Branch (see notes)

0.5	TEE																		
0.75	RTEE	TEE																	
1	RTEE	RTEE	TEE																
1.5	RTEE	RTEE	RTEE	TEE															
2	SOC	SOC	SOC	SOC	TEE														
3	SOC	SOC	SOC	SOC	RTEE	TEE													
4	SOC	SOC	SOC	SOC	RTEE	RTEE	TEE												
6	SOC	SOC	SOC	SOC	WOL	RTEE	RTEE	TEE											
8	SOC	SOC	SOC	SOC	WOL	WOL	RTEE	RTEE	TEE										
10	SOC	SOC	SOC	SOC	WOL	WOL	WOL	RTEE	RTEE	TEE									
12	SOC	SOC	SOC	SOC	WOL	WOL	WOL	RTEE	RTEE	RTEE	TEE								
14	SOC	SOC	SOC	SOC	WOL	WOL	WOL	RTEE	RTEE	RTEE	RTEE	TEE							
16	SOC	SOC	SOC	SOC	WOL	WOL	WOL	RTEE	RTEE	RTEE	RTEE	RTEE	TEE						
18	SOC	SOC	SOC	SOC	WOL	WOL	WOL	WOL	RTEE	RTEE	RTEE	RTEE	RTEE	TEE					
20	SOC	SOC	SOC	SOC	WOL	WOL	WOL	WOL	RTEE	RTEE	RTEE	RTEE	RTEE	RTEE	TEE				
24	SOC	SOC	SOC	SOC	WOL	WOL	WOL	WOL	RTEE	RTEE	RTEE	RTEE	RTEE	RTEE	RTEE	TEE			
0.5	0.75	1	1.5	2	3	4	6	8	10	12	14	16	18	20	24				

- WOL - Weldolet
- TEE - Tee
- RTEE - Red Tee
- HC - Half Coupling
- SOC - Sockolet

Notes

- On the spec valve list, it may have valves codes which contain values of process data lower than spec limits. It shall be verified all valve process data (e.g.: pressure, temperature) in order to specify it according the design premisses.
- See Annex A for valves requirements and general selection criteria.
- Bolts,nuts and gaskets (only RTJ gaskets) must be Zn-Ni coated according to Annex B.
- See Annex C for instruments, drains and vents typical piping arrangement.
- Flanges ≤ 1 1/2" may be used, if strictly necessary.
- See Annex E for Isolation gasket specifications.
- Welding and Welding Inspection activities shall follow the requeriments of these documents: I-ET-3010.00-1200-955-P4X-001-Welding and I-ET-3010.00-1200-955-P4X-002-Requirements for Welding Inspection
- All valves, pipes and components specified for hydrogen sulfide service shall be in accordance with ISO 15156 requirements.
- Charpy impact test is required at the minimum temperature of this spec, according to ASME B31.3 and standard material specification.
- Wafer valves are not to be used with flammable or combustible services, according to NFPA definition.
- Materials shall follow the requirements of IOGP S-563- Material Data Sheets for Piping and Valve Components. Coating for bolts and nuts shall follow spec note number 3.

		OFFSHORE PRODUCTION FACILITIES				Doc: I-ET-3010.1M-1200-200- P4X-001	Revision: F	Sheet 1 of 2
		PIPING SPECIFICATION FOR TOPSIDE					Issued by: SRGE/ESUP	Code: ASME B31.3



Services (see notes): DO - Carbon Dioxide (DRY);	Material: Galv. CS	Class: 300	Standard: C8
---	-----------------------	---------------	-----------------

Pressure Rating (see notes)

Temperature (°C)	-18	0	38	54						
Max Pressure (barg)	51.1	51.1	51.1	49.8						

Pipes and Fittings (see notes)

Items		Code	Size	Wall	Class	Ends	Standard	Material
Pipes	Pipe	T-102	1/2" - 1 1/2"	XS	-	PE	ASME B36.10	API 5L Gr B PSL 1 SML
			2" - 6"	STD		BE		API 5L Gr B PSL 1 (SML or WLD HFW or WLD SAW)
			8"	S-20				
Fittings	90 Elbow	C01-02	1/2" - 1 1/2"	-	3000	SW	ASME B16.11	ASTM A105
	45 Elbow	C02-02						
	Tee	C03-02						
	Cross	C05-02						
	Coupling	C06-02						
	Union	C10-02						
	Cap	C11-02						
	90 LR Elbow	C15-03	2" - 8"	According to pipe	-	BE	ASME B16.9	ASTM A234 Gr WPB
	45 LR Elbow	C16-03						
	90 SR Elbow	C17-03						
	Tee	C20-03						
	Cap	C22-03						
	Cross	C24-03						
	Conc. Red	C18-03						
	Ecc. Red	C19-03	3" - 8"					
	Red Tee	C21-03						
	Nipple	Straight Nipple	N-S120	1/2" - 1 1/2"	According to pipe	-	PBE	ASTM A733
Swage Conc Nipple		N-C103	3/4" - 1 1/2"	BLE x PSE			MSS SP-95	ASTM A234 Gr WPB
		N-C403	2" - 4"	PBE				
Swage Ecc Nipple		N-E103	3/4" - 1 1/2"	BLE x PSE				
	N-E403	2" - 4"						
Bolts & Gasket Flanges	Welding Neck (WN)	F-300-K2	1/2" - 8"	According to pipe	Class 300	Raised Face	ASME B16.5	ASTM A105
	Blind	F-300-L2						
Bolts & Nuts	Flat type	J-300-PA	1/2" - 8"	-	Class 300	Raised Face	ASME B16.21	Aramid/NBR
								Stud and Nuts

		OFFSHORE PRODUCTION FACILITIES				Doc: I-ET-3010.1M-1200-200-P4X-001	Revision: F	Sheet: 2 of 2
		PIPING SPECIFICATION FOR TOPSIDE						Material: Galv. CS

Valves (see notes)

Type	Size	CODE	Temp	Type	Size	CODE	Temp	Type	Size	CODE	Temp	Type	Size	CODE	Temp
Ball	1" - 1 1/2"	VES-800-1-C103	-29C to 120C	Ball	1" - 1 1/2"	VES-800-2-C103	-29C to 120C	Check	1/2" - 1 1/2"	VRE-800-1-C102	-29C to 400C	Check	2" - 8"	VRE-300-1-C111	0C to 150C

Branch (see notes)



RUN SIZE	0.5	TEE															
	0.75	RTEE	TEE														
	1	RTEE	RTEE	TEE													
	1.5	RTEE	RTEE	RTEE	TEE												
	2	SOC	SOC	SOC	SOC	TEE											
	3	SOC	SOC	SOC	SOC	RTEE	TEE										
	4	SOC	SOC	SOC	SOC	RTEE	RTEE	TEE									
	6	SOC	SOC	SOC	SOC	WOL	RTEE	RTEE	TEE								
	8	SOC	SOC	SOC	SOC	WOL	WOL	RTEE	RTEE	TEE							
	0.5	0.75	1	1.5	2	3	4	6	8								

BRANCH SIZE

- WOL - Weldolet
- TEE - Tee
- RTEE - Red Tee
- HC - Half Coupling
- SOC - Sockolet

Notes

1	On the spec valve list, it may have valves codes which contain values of process data lower than spec limits. It shall be verified all valve process data (e.g.: pressure, temperature) in order to specify it according the design premisses.
2	See Annex A for valves requirements and general selection criteria.
3	Bolts, nuts and gaskets (only RTJ gaskets) must be Zn-Ni coated according to Annex B.
4	See Annex C for instruments, drains and vents typical piping arrangement.
5	Flanges ≤ 1 1/2" may be used, if strictly necessary.
6	See Annex E for Isolation gasket specifications.
7	Welding and Welding Inspection activities shall follow the requirements of these documents: I-ET-3010.00-1200-955-P4X-001-Welding and I-ET-3010.00-1200-955-P4X-002-Requirements for Welding Inspection
52	Piping, fittings and accessories must be galvanized after spool fabrication according to ASTM A123 with minimum coating thickness of 100µm.
63	From -18°C to 0°C, API 5L gr B shall be furnished normalized.
68	This Spec shall be applied for distribution system of CO2, after directional valves.
125	Materials shall follow the requirements of IOGP S-563- Material Data Sheets for Piping and Valve Components. Coating for bolts and nuts shall follow spec note number 3.



		OFFSHORE PRODUCTION FACILITIES						Doc: I-ET-3010.1M-1200-200- P4X-001	Revision: F	Sheet 1 of 2
		PIPING SPECIFICATION FOR TOPSIDE						Issued by: SRGE/ESUP	Code: ASME B31.3	Corr. Allow. : 3.2 mm

Services (see notes): PC - Process (Corrosive Hydrocarbon);	Material: Carbon Steel	Class: 300	Standard: C9
--	---------------------------	---------------	-----------------

Pressure Rating (see notes)										
Temperature (°C)	0	38	50	100	150	200	240			
Max Pressure (barg)	51.1	51.1	50.1	46.6	45.1	43.8	42.2			

Pipes and Fittings (see notes)

Items	Code	Size	Wall	Class	Ends	Standard	Material	
Pipes	Pipe	T-102	1/2" - 1 1/2"	S-160	-	PE	ASME B36.10	API 5L Gr B PSL 1 SML
			2" - 3"	XS		BE		API 5L Gr B PSL 1 (SML or WLD HFW or WLD SAW)
			4"	0.250"				
			6"	0.312"				
			8"	S-60				
			10"	0.438"				
			12" - 14"	XS				
			16"	0.562"				
			18" - 20"	0.625"				
			24"	0.750"				
26"	0.688"							
28"	0.750"							
30" - 32"	0.812"							
Fittings	90 Elbow	C01-02	1/2" - 1 1/2"	-	6000	SW	ASME B16.11	ASTM A105
	45 Elbow	C02-02						
	Tee	C03-02						
	Cross	C05-02						
	Coupling	C06-02						
	Cap	C11-02						
	Socket	C55-02						
	Red Tee	C04-02						
	Red Coupling	C08-02						
	Weldolet	C12-02						
	90 LR Elbow	C15-03	3/4" - 1 1/2"	-	-	BE	ASME B16.11	ASTM A234 Gr WPB
	45 LR Elbow	C16-03						
	90 SR Elbow	C17-03						
	Tee	C20-03						
	Cap	C22-03						
	Cross	C24-03						
	Conc. Red	C18-03	2" - 32"	According to pipe	-	BE	ASME B16.9	ASTM A234 Gr WPB
	Ecc. Red	C19-03						
Red Tee	C21-03							
Weldolet	C12-02							
90 LR Elbow	C15-03	4" - 14"	-	-	BE	ASME B16.9	ASTM A105	
45 LR Elbow	C16-03							
90 SR Elbow	C17-03	3" - 32"	According to pipe	-	BE	ASME B16.9	ASTM A234 Gr WPB	
Tee	C20-03							
Cap	C22-03	4" - 14"	-	-	BE	ASME B16.9	ASTM A234 Gr WPB	
Cross	C24-03							
Conc. Red	C18-03	3" - 32"	According to pipe	-	BE	ASME B16.9	ASTM A234 Gr WPB	
Ecc. Red	C19-03							
Red Tee	C21-03	4" - 14"	-	-	BE	ASME B16.9	ASTM A234 Gr WPB	
Weldolet	C12-02							
Nipple	Straight Nipple	N-S120	1/2" - 1 1/2"	According to pipe	-	PBE	ASME B16.5	ASTM A105
	Swage Conc Nipple	N-C103	3/4" - 1 1/2"			BLE x PSE	MSS SP-95	ASTM A234 Gr WPB
	Swage Ecc Nipple	N-E103	3/4" - 1 1/2"			PBE		
		N-E403	2" - 4"			BLE x PSE		
Flanges	Socket Weld (SW)	F-300-J2	1/2" - 1 1/2"	According to pipe	Class 300	Raised Face	ASME B16.5	ASTM A105
	Welding Neck (WN)	F-300-K2	2" - 24"				ASME B16.47 A	
			26" - 32"				ASME B16.5	
	Blind	F-300-L2	1/2" - 24"				ASME B16.47 A	
26" - 32"			ASME B16.47 A					
Bolts & Nuts	Spiral-Wound	J-300-EH	1/2" - 32"	-	Class 300	Raised Face	ASME B16.20	AISI 316/graphite
							ASME B1.1	A193 B7, Zn-Ni
Bolts & Nuts	Stud and Nuts	P-300-07	1/2" - 1 7/8"	-	-	-	ASME B1.1	A194 Gr 2H, Zn-Ni
							ASME B1.1	A194 Gr 2H, Zn-Ni



		OFFSHORE PRODUCTION FACILITIES				Doc: I-ET-3010.1M-1200-200- P4X-001	Revision: F	Sheet 1 of 2
		PIPING SPECIFICATION FOR TOPSIDE					Issued by: SRGE/ESUP	Code: ASME B31.3

Services (see notes): AM - Amine; BG - Inert Gas; CI - Chemical Injection (non-corrosive); D - Diesel; FG - Fuel Gas; G - Glycol; IW - De-Aerated Sea Water Injection; P - Process (non-corrosive hydrocarbon); SA - Service Compressed Air (utility Air); SN - Start-up Nitrogen; W - Industrial water;	Material: Carbon Steel	Class: 300	Standard: C10
---	----------------------------------	----------------------	-------------------------

Pressure Rating (see notes)										
Temperature (°C)	0	38	50	100	150	200	240			
Max Pressure (barg)	51.1	51.1	50.1	46.6	45.1	43.8	42.2			

Pipes and Fittings (see notes)

Items	Code	Size	Wall	Class	Ends	Standard	Material						
Pipes	Pipe	T-102	1/2" - 1 1/2"	S-160	-	PE	API 5L Gr B PSL 1 SML						
			2" - 12"	STD		BE	ASME B36.10	API 5L Gr B PSL 1 (SML or WLD HFW or WLD SAW)					
			14"	0.406"				API 5L Gr B PSL 1 WLD (HFW or SAW)					
			16"	0.469"									
			18"	XS									
			20"	0.562"									
			24"	S-40									
			26"	0.625"									
			28"	0.688"									
30" - 32"	0.750"	API 5L Gr B PSL 1 WLD SAW											
Fittings	90 Elbow	C01-02	1/2" - 1 1/2"	-	6000	SW	ASME B16.11	ASTM A105					
	45 Elbow	C02-02											
	Tee	C03-02											
	Cross	C05-02											
	Coupling	C06-02											
	Cap	C11-02											
	Socketlet	C55-02	3/4" - 1 1/2"	-	-	ASME B16.11	ASTM A234 Gr WPB						
	Red Tee	C04-02											
	Red Coupling	C08-02											
	Weldolet	C12-02	2" - 14"	According to pipe	-	BE	ASME B16.9	ASTM A234 Gr WPB					
	90 LR Elbow	C15-03											
	45 LR Elbow	C16-03											
	90 SR Elbow	C17-03											
	Tee	C20-03											
	Cap	C22-03											
	Cross	C24-03											
	Conc. Red	C18-03	3" - 32"						-	-	ASME B16.9	ASTM A234 Gr WPB	
	Ecc. Red	C19-03											
Red Tee	C21-03												
Nipple	Straight Nipple	N-S120	1" - 1 1/2"						According to pipe	-	PBE	ASTM A733	API 5L Gr B PSL 1 seamless
	Swage Conc Nipple	N-C103	3/4" - 1 1/2"								BLE x PSE	MSS SP-95	ASTM A234 Gr WPB
		N-C403	2" - 4"										
	Swage Ecc Nipple	N-E103	3/4" - 1 1/2"	2" - 4"	PBE	ASTM A234 Gr WPB							
N-E403		2" - 4"											
Flanges	Socket Weld (SW)	F-300-J2	1/2" - 1 1/2"	According to pipe	Class 300	Raised Face	ASME B16.5	ASTM A105					
	Welding Neck (WN)	F-300-K2	2" - 24"				ASME B16.47 A						
			26" - 32"				ASME B16.5						
	Blind	F-300-L2	1/2" - 24"				ASME B16.47 A						
Bolts & Gasket Nuts	Spiral-Wound	J-300-EH	1/2" - 32"	-	Class 300	Raised Face	ASME B16.20	AISI 316/graphite					
	Stud and Nuts	P-300-07	1/2" - 1 7/8"	-	-	-	ASME B1.1	A193 B7, Zn-Ni A194 Gr 2H, Zn-Ni					

		OFFSHORE PRODUCTION FACILITIES	Doc:	I-ET-3010.1M-1200-200-P4X-001	Revision:	F	Sheet:	2 of 2	
		PIPING SPECIFICATION FOR TOPSIDE				Material:	Carbon Steel	Class:	300

Valves (see notes)



Type	Size	CODE	Temp	Type	Size	CODE	Temp	Type	Size	CODE	Temp	Type	Size	CODE	Temp					
Needle	1/2" - 1 1/2"	VAG-3000-1-S201	-100C to 200C	Ball	2" - 32"	VES-300-1-C180	0C to 400C	Ball	2" - 32"	VES-300-3-C126	0C to 150C	Double Ball	1/2" - 2"	VDE-300-2-C202	-30C to 150C					
		VAG-3000-1-S202	-100C to 400C			VES-300-2-C110	-29C to 150C			VES-300-3-C127					VDE-300-2-C205	-46C to 200C				
Butterfly	10" - 32"	VBO-300-2-C113	0C to 240C			VES-300-2-C116				VES-300-3-C136					VDE-300-2-C206					
	10" - 24"	VBO-300-3-C123	-29C to 240C			VES-300-2-C120				VES-300-3-C137			VDE-300-2-C114	-29C to 150C						
Ball	1/2" - 1 1/2"	VES-803-1-C101	0C to 150C			VES-300-2-C126	0C to 150C			VES-300-3-C152		0C to 210C	Gate	1/2" - 1 1/2"	VGA-801-1-C101	-29C to 400C	Globe	2" - 18"	VGL-300-2-C101	-29C to 400C
		VES-803-1-C102	0C to 150C			VES-300-2-C130									VES-300-3-C153					VGA-300-1-C101
		VES-803-1-C105	0C to 210C			VES-300-2-C136				0C to 210C			VES-300-3-C162	0C to 400C	Plug	2" - 24"	VMA-300-2-C101	0C to 93C		
		VES-803-2-C101	-29C to 150C			VES-300-2-C150											VES-300-3-C163		VRE-800-1-C103	-29C to 400C
		VES-803-2-C102	0C to 150C			VES-300-2-C152							-29C to 150C		VES-300-3-C172		VRE-300-1-C111	0C to 150C		
		VES-803-2-C105	0C to 210C			VES-300-2-C160				0C to 210C			VES-300-3-C173	0C to 150C	Check	2" - 24"	VRE-300-2-C112	-29C to 400C		
	VES-803-3-C105	0C to 210C	VES-300-2-C162				VES-300-3-C182					0C to 400C	VRE-300-2-C115				-29C to 400C			
	VES-300-1-C110	-29C to 150C	VES-300-2-C170		VES-300-3-C183	0C to 150C	Double Ball	1/2" - 2"	VRE-300-2-C116	-29C to 400C										
	VES-300-1-C120	0C to 150C	VES-300-2-C172		VES-300-4-C154	0C to 150C			VRE-300-2-C135	-29C to 210C										
	VES-300-1-C130	0C to 150C	VES-300-2-C180	0C to 400C	VES-300-4-C164	0C to 210C														
	VES-300-1-C150		VES-300-2-C182	0C to 400C	VES-300-4-C174	0C to 210C														
	VES-300-1-C160		VES-300-3-C116	-29C to 150C	VES-300-4-C184	0C to 400C														
	VES-300-1-C170	0C to 210C	VES-300-3-C117	-29C to 150C																

Branch (see notes)

Run Size	Branch Size	Run Size	Branch Size	Run Size	Branch Size	Run Size	Branch Size														
0.5	TEE	0.5	TEE	0.5	TEE	0.5	TEE														
0.75	RTEE	TEE	0.75	RTEE	TEE	0.75	RTEE														
1	RTEE	RTEE	TEE	1	RTEE	RTEE	TEE														
1.5	RTEE	RTEE	RTEE	TEE	1.5	RTEE	RTEE														
2	SOC	SOC	SOC	SOC	TEE	2	SOC														
3	SOC	SOC	SOC	RTEE	TEE	3	SOC														
4	SOC	SOC	SOC	RTEE	RTEE	TEE	4	SOC													
6	SOC	SOC	SOC	WOL	RTEE	RTEE	TEE	6	SOC												
8	SOC	SOC	SOC	WOL	WOL	RTEE	RTEE	TEE	8	SOC											
10	SOC	SOC	SOC	WOL	WOL	WOL	RTEE	RTEE	TEE	10	SOC										
12	SOC	SOC	SOC	WOL	WOL	WOL	RTEE	RTEE	RTEE	TEE	12	SOC									
14	SOC	SOC	SOC	WOL	WOL	WOL	RTEE	RTEE	RTEE	RTEE	TEE	14	SOC								
16	SOC	SOC	SOC	WOL	WOL	WOL	RTEE	RTEE	RTEE	RTEE	RTEE	TEE	16	SOC							
18	SOC	SOC	SOC	WOL	WOL	WOL	WOL	RTEE	RTEE	RTEE	RTEE	RTEE	TEE	18	SOC						
20	SOC	SOC	SOC	WOL	WOL	WOL	WOL	RTEE	RTEE	RTEE	RTEE	RTEE	RTEE	TEE	20	SOC					
24	SOC	SOC	SOC	WOL	WOL	WOL	WOL	WOL	RTEE	RTEE	RTEE	RTEE	RTEE	RTEE	TEE	24	SOC				
26	SOC	SOC	SOC	WOL	WOL	WOL	WOL	WOL	WOL	RTEE	RTEE	RTEE	RTEE	RTEE	RTEE	TEE	26	SOC			
28	SOC	SOC	SOC	WOL	WOL	WOL	WOL	WOL	WOL	RTEE	RTEE	RTEE	RTEE	RTEE	RTEE	RTEE	TEE	28	SOC		
30	SOC	SOC	SOC	WOL	WOL	WOL	WOL	WOL	WOL	WOL	RTEE	RTEE	RTEE	RTEE	RTEE	RTEE	RTEE	TEE	30	SOC	
32	SOC	SOC	SOC	WOL	WOL	WOL	WOL	WOL	WOL	WOL	RTEE	RTEE	RTEE	RTEE	RTEE	RTEE	RTEE	RTEE	TEE	32	SOC

Notes

1	On the spec valve list, it may have valves codes which contain values of process data lower than spec limits. It shall be verified all valve process data (e.g.: pressure, temperature) in order to specify it according the design premisses.
2	See Annex A for valves requirements and general selection criteria.
3	Bolts, nuts and gaskets (only RTJ gaskets) must be Zn-Ni coated according to Annex B.
4	See Annex C for instruments, drains and vents typical piping arrangement.
5	Flanges ≤ 1 1/2" may be used, if strictly necessary.
6	See Annex E for Isolation gasket specifications.
7	Welding and Welding Inspection activities shall follow the requirements of these documents: I-ET-3010.00-1200-955-P4X-001-Welding and I-ET-3010.00-1200-955-P4X-002-Requirements for Welding Inspection
8	All valves, pipes and components specified for hydrogen sulfide service shall be in accordance with ISO 15156 requirements.
40	The IW service is only applicable for onshore units.
46	Diesel service "D" is only applicable for piping upstream the centrifuge.
56	This spec for FG service is applicable for piping upstream the filters.
83	This spec for Amine service is applicable for booster pump discharge.
120	Wafer valves are not to be used with flammable or combustible services, according to NFPA definition.
125	Materials shall follow the requirements of IOGP S-563- Material Data Sheets for Piping and Valve Components. Coating for bolts and nuts shall follow spec note number 3.

		OFFSHORE PRODUCTION FACILITIES				Doc: I-ET-3010.1M-1200-200- P4X-001	Revision: F	Sheet 1 of 2
		PIPING SPECIFICATION FOR TOPSIDE					Issued by: SRGE/ESUP	Code: ASME B31.3

Services (see notes): PCW - Produced water;	Material: Organic Coat CS	Class: 300	Standard: C11
--	---------------------------------	---------------	------------------

Pressure Rating (see notes)

Temperature (°C)	0	38	50	100	120						
Max Pressure (barg)	51.1	51.1	50.1	46.6	46						

Pipes and Fittings (see notes)

Items		Code	Size	Wall	Class	Ends	Standard	Material	
Pipes	Pipe	T-102	1" - 1 1/2"	XS	-	PE	ASME B36.10	API 5L Gr B PSL 1 SML	
			2" - 6"	STD		BE		ASME B36.10	API 5L Gr B PSL 1 (SML or WLD HFW or WLD SAW)
			8"	S-20					
			10"	0.279"					
			12"	0.312"					
			14"	0.344"					
16"	0.406"			API 5L Gr B PSL 1 WLD (HFW or SAW)					
Fittings	Weldolet	C 12-02	1" - 6"	According to pipe	-	BE	MSS SP-97	ASTM A105	
	90 LR Elbow	C 15-03	1" - 16"			BE	ASME B16.9	ASTM A234 Gr WPB	
	45 LR Elbow	C 16-03							
	90 SR Elbow	C 17-03							
	Tee	C 20-03							
	Cap	C 22-03							
	Cross	C 24-03							
	Conc. Red	C 18-03							
	Ecc. Red	C 19-03	1 1/2" - 16"						
	Red Tee	C 21-03							
Swage Flanges Nipple	Swage Conc Nipple	N-C203	1 1/2" - 4"	According to pipe	-	BBE	MSS SP-95	ASTM A234 Gr WPB	
	Swage Ecc Nipple	N-E203							
Gasketed Flanges	Welding Neck (WN)	F-300-K2	1" - 16"	According to pipe	Class 300	Raised Face	ASME B16.5	ASTM A105	
	Blind	F-300-L2							
Gasketed Flanges	Flat type	J-300-PC	1" - 16"	-	Class 300	Raised Face	ASME B16.21	Multidirectional Expanded PTFE	
	Bolts & Nuts	Stud and Nuts	P-300-07	1/2" - 1 1/4"	-	-	-	ASME B1.1	A193 B7, Zn-Ni
								A194 Gr 2H, Zn-Ni	



OFFSHORE PRODUCTION FACILITIES

Doc:
I-ET-3010.1M-1200-200-P4X-001

Revision:
F

Sheet:
2 of 2

PIPING SPECIFICATION FOR TOPSIDE

Material:
Organic
Coat CS

Class:
300

Standard:
C11

Valves (see notes)

Type	Size	CODE	Temp	Type	Size	CODE	Temp	Type	Size	CODE	Temp	Type	Size	CODE	Temp
Butterfly	6" - 16"	VBO-300-2-D211	-46C to 150C	Ball	1" - 1 1/2"	VES-300-2-D200	0C to 150C	Ball	2" - 16"	VES-300-3-D217	-30C to 150C	Check	2" - 16"	VGL-300-2-D201	-46C to 150C
		VBO-300-2-D212				VES-300-1-D210				VGA-300-1-D201				VRE-300-1-D211	
		VBO-300-2-D213				VES-300-2-D110				VGA-300-2-D201				VRE-300-1-D212	
		VBO-300-3-D223				VES-300-2-D210				VGL-300-1-D201				VRE-300-2-D212	
Ball	1" - 1 1/2"	VES-300-1-D200	0C to 150C			VES-300-3-D216	-30C to 150C			VGL-300-2-D101	0C to 150C			VRE-300-2-D235	-46C to 150C



Branch (see notes)

RUN SIZE	1	TEE	BRANCH SIZE	1	1.5	2	3	4	6	8	10	12	14	16
	1.5	RTEE		TEE	1.5	2	3	4	6	8	10	12	14	16
	2	RTEE		RTEE	TEE	2	3	4	6	8	10	12	14	16
	3	WOL		RTEE	RTEE	TEE	3	4	6	8	10	12	14	16
	4	WOL		WOL	RTEE	RTEE	TEE	4	6	8	10	12	14	16
	6	WOL		WOL	WOL	RTEE	RTEE	TEE	6	8	10	12	14	16
	8	WOL		WOL	WOL	WOL	RTEE	RTEE	TEE	8	10	12	14	16
	10	WOL		WOL	WOL	WOL	WOL	RTEE	RTEE	TEE	10	12	14	16
	12	WOL		WOL	WOL	WOL	WOL	WOL	RTEE	RTEE	TEE	12	14	16
	14	WOL		WOL	WOL	WOL	WOL	WOL	WOL	RTEE	RTEE	TEE	14	16
	16	WOL		WOL	WOL	WOL	WOL	WOL	WOL	WOL	RTEE	RTEE	TEE	16

WOL - Weldolet
TEE - Tee
RTEE - Red Tee
HC - Half Coupling
SOC - Sockolet

Notes

1	On the spec valve list, it may have valves codes which contain values of process data lower than spec limits. It shall be verified all valve process data (e.g.: pressure, temperature) in order to specify it according the design premisses.
2	See Annex A for valves requirements and general selection criteria.
3	Bolts,nuts and gaskets (only RTJ gaskets) must be Zn-Ni coated according to Annex B.
4	See Annex C for instruments, drains and vents typical piping arrangement.
6	See Annex E for Isolation gasket specifications.
7	Welding and Welding Inspection activities shall follow the requeriments of these documents: I-ET-3010.00-1200-955-P4X-001-Welding and I-ET-3010.00-1200-955-P4X-002-Requirements for Welding Inspection
50	Piping, fittings and accessories shall be organic coated internally acc. to I-ET-3010.00-1200-956-P4X-002 - General Painting.
125	Materials shall follow the requirements of IOGP S-563- Material Data Sheets for Piping and Valve Components. Coating for bolts and nuts shall follow spec note number 3.

		OFFSHORE PRODUCTION FACILITIES				Doc: I-ET-3010.1M-1200-200- P4X-001	Revision: F	Sheet 1 of 2
		PIPING SPECIFICATION FOR TOPSIDE					Issued by: SRGE/ESUP	Code: ASME B31.3

Services (see notes): PC - Process (Corrosive Hydrocarbon); PCW - Produced water;	Material: Super Duplex	Class: 300	Standard: C12
--	---------------------------	---------------	------------------

Pressure Rating (see notes)										
Temperature (°C)	0	38	50	100	140					
Max Pressure (barg)	51.7	51.7	51.7	50.7	46.8					

Pipes and Fittings (see notes)

Items		Code	Size	Wall	Class	Ends	Standard	Material					
Pipes	Pipe	T-303	1/2" - 1 1/2" 2" - 8"	S-40S	-	PE	ASME B36.10/B36.19	ASTM A790 (UNS S32760) SML					
		T-304	10" - 24" 26" - 30"			BE		ASTM A928 (UNS S32760 Cl 1 or 3) WLD					
				0.375"									
Fittings	90 Elbow	C01-30	1/2" - 1 1/2"	-	3000	SW	ASME B16.11	ASTM A182 Gr F55 (UNS S32760)					
	45 Elbow	C02-30											
	Tee	C03-30											
	Cross	C05-30											
	Coupling	C06-30											
	Cap	C11-30											
	Socket	C55-30											
	Red Tee	C04-30	3/4" - 1 1/2"	-	3000	SW	ASME B16.11	ASTM A182 Gr F55 (UNS S32760)					
	Red Coupling	C08-30											
	Weldolet	C12-30	1" 2" - 14"	According to pipe	-	BE	MSS SP-97	ASTM A815 (UNS S32760)					
	90 LR Elbow	C15-32	2" - 30"										
	45 LR Elbow	C16-32											
	90 SR Elbow	C17-32											
	Tee	C20-32											
	Cap	C22-32											
Cross	C24-32												
Conc. Red	C18-32												
Ecc. Red	C19-32	3" - 30"											
Red Tee	C21-32												
Nipple	Straight Nipple	N-S131	1/2" - 1 1/2"						According to pipe	-	PBE	ASTM A733	ASTM A790 (UNS S32760)
	Swage Conc Nipple	N-C132	3/4" - 1 1/2"								BLE x PSE	MSS SP-95	ASTM A815 (UNS S32760)
		N-C432	2" - 4"										
	Swage Ecc Nipple	N-E132	3/4" - 1 1/2"								2" - 4"	BLE x PSE	ASTM A815 (UNS S31803)
N-E429		2" - 4"											
Flanges	Socket Weld (SW)	F-300-JH	1/2" - 1 1/2"	According to pipe	Class 300	Raised Face	ASME B16.5	ASTM A182 Gr F55					
	Welding Neck (WN)	F-300-KH	2" - 24"				ASME B16.47 A						
			26" - 30"				ASME B16.5						
	Blind	F-300-LH	1/2" - 24" 26" - 30"				ASME B16.47 A						
Bolts & Gasket Nuts	Spiral-Wound	J-300-EL	1/2" - 30"	-	Class 300	Raised Face	ASME B16.20	Duplex/graphite					
	Stud and Nuts	P-300-07	1/2" - 1 3/4"	-	-	-	ASME B1.1	A193 B7, Zn-Ni					
A194 Gr 2H, Zn-Ni													



OFFSHORE PRODUCTION FACILITIES

Doc:
I-ET-3010.1M-1200-200-P4X-001

Revision:
F

Sheet:
2 of 2

PIPING SPECIFICATION FOR TOPSIDE

Material:
Super Duplex

Class:
300

Standard:
C12

Valves (see notes)

Type	Size	CODE	Temp	Type	Size	CODE	Temp	Type	Size	CODE	Temp	Type	Size	CODE	Temp	
Needle	1/2" - 1 1/2"	VAG-3000-1-D302	-46C to 150C			VES-300-1-D330	0C to 150C			VES-300-3-D353		Double Ball	3" - 8"	VDE-300-2-D334	-46C to 150C	
Butterfly	6" - 30"	VBO-300-2-D312	0C to 150C	Ball	2" - 30"	VES-300-2-D310	-30C to 150C	Ball	2" - 30"	VES-300-3-D372	0C to 150C	Gate	1/2" - 1 1/2"	VGA-801-1-D301	-50C to 150C	
		VBO-300-2-D313				VES-300-2-D316				VES-300-3-D373				VGA-300-1-D301		
		VBO-300-3-D323	-46C to 150C			VES-300-2-D330	0C to 150C			VES-300-4-D354				-30C to 150C	VGL-300-2-D301	-46C to 150C
Ball	1/2" - 1 1/2"	VES-801-1-D301	0C to 150C	VES-300-2-D336	-30C to 150C	VDE-300-2-D301	-30C to 150C	Double Ball	1/2" - 2"	VDE-300-2-D302	-46C to 150C	Check	2" - 30"		VRE-800-1-D302	-46C to 150C
		VES-801-1-D305		VES-300-3-D316		VDE-300-2-D303				VRE-800-2-D302					-50C to 150C	
		VES-801-2-D301		VES-300-3-D317		VDE-300-2-D303				VRE-300-1-D312				-50C to 150C		
		VES-801-2-D305		VES-300-3-D336		VDE-300-2-D303				VRE-300-2-D315				-46C to 150C		
		VES-801-3-D305		VES-300-3-D337		VDE-300-2-D304				VRE-300-2-D335						
		VES-300-1-D310		-30C to 150C		VES-300-3-D352										



Branch (see notes)

Run Size	Branch Size	TEE	RTEE	HC	SOC	WOL
0.5	0.5					
0.75	0.75					
1	1					
1.5	1.5					
2	2					
3	3					
4	4					
6	6					
8	8					
10	10					
12	12					
14	14					
16	16					
18	18					
20	20					
24	24					
26	26					
28	28					
30	30					

- WOL - Weldolet
- TEE - Tee
- RTEE - Red Tee
- HC - Half Coupling
- SOC - Sockolet

Notes

1	On the spec valve list, it may have valves codes which contain values of process data lower than spec limits. It shall be verified all valve process data (e.g.: pressure, temperature) in order to specify it according the design premisses.
2	See Annex A for valves requirements and general selection criteria.
3	Bolts, nuts and gaskets (only RTJ gaskets) must be Zn-Ni coated according to Annex B.
4	See Annex C for instruments, drains and vents typical piping arrangement.
5	Flanges ≤ 1 1/2" may be used, if strictly necessary.
6	See Annex E for Isolation gasket specifications.
7	Welding and Welding Inspection activities shall follow the requirements of these documents: I-ET-3010.00-1200-955-P4X-001-Welding and I-ET-3010.00-1200-955-P4X-002-Requirements for Welding Inspection
8	All valves, pipes and components specified for hydrogen sulfide service shall be in accordance with ISO 15156 requirements.
26	See Annex A for valve casting qualification requirements.
27	See Annex D to check the piping spec range application for H2S and CO2 service.
48	SuperDuplex Stainless Steel external coating shall be applied for the temperature limits acc. to I-ET-3010.00-1200-956-P4X-002 - General Painting.
120	Wafer valves are not to be used with flammable or combustible services, according to NFPA definition.
122	Inspection of pipe and piping components shall follow ASTM A923 requirements.
123	The application of this pipe specification for PCW - Produced Water is conditioned to maximum oxygen content 20 ppb and max temperature 120°C.
125	Materials shall follow the requirements of IOGP S-563- Material Data Sheets for Piping and Valve Components. Coating for bolts and nuts shall follow spec note number 3.

		OFFSHORE PRODUCTION FACILITIES				Doc: I-ET-3010.1M-1200-200- P4X-001	Revision: F	Sheet 1 of 2
		PIPING SPECIFICATION FOR TOPSIDE					Issued by: SRGE/ESUP	Code: ASME B31.3

Services (see notes): AM - Amine; PC - Process (Corrosive Hydrocarbon);	Material: Duplex	Class: 300	Standard: C16
--	---------------------	---------------	------------------

Pressure Rating (see notes)										
Temperature (°C)	-46	0	38	50	100	130				
Max Pressure (barg)	51.7	51.7	51.7	51.7	50.7	47.8				

Pipes and Fittings (see notes)

Items		Code	Size	Wall	Class	Ends	Standard	Material				
Pipes	Pipe	T-301	1/2" - 1 1/2"	S-40S	-	PE	ASME B36.10/B36.19	ASTM A790 (UNS S31803) SML				
		T-302	2" - 8"			BE		ASTM A928 (UNS S31803 C1 1 or 3) WLD				
			10" - 24"									
Fittings	90 Elbow	C01-27	1/2" - 1 1/2"	-	3000	SW	ASME B16.11	ASTM A182 Gr F51 (UNS S31803)				
	45 Elbow	C02-27										
	Tee	C03-27										
	Cross	C05-27										
	Coupling	C06-27										
	Cap	C11-27										
	Socketlet	C55-27										
	Red Tee	C04-27	3/4" - 1 1/2"	-	3000	SW	ASME B16.11	ASTM A182 Gr F51 (UNS S31803)				
	Red Coupling	C08-27										
	Weldolet	C12-27	2" - 10"	According to pipe	-	-	BE	MSS SP-97				
	90 LR Elbow	C15-29	2" - 24"				-	-	-	-	ASME B16.9	ASTM A815 (UNS S31803)
	45 LR Elbow	C16-29										
	90 SR Elbow	C17-29										
	Tee	C20-29										
	Cap	C22-29										
Cross	C24-29											
Conc. Red	C18-29											
Ecc. Red	C19-29	3" - 24"	-				-	-	BE	ASME B16.9	ASTM A815 (UNS S31803)	
Red Tee	C21-29											
Nipple	Straight Nipple	N-S128	1/2" - 1 1/2"				According to pipe	-	-	PBE	ASTM A733	ASTM A790 (UNS S31803)
	Swage Conc Nipple	N-C129	3/4" - 1 1/2"							BLE x PSE	MSS SP-95	ASTM A815 (UNS S31803)
		N-C429	2" - 4"									
	Swage Ecc Nipple	N-E129	3/4" - 1 1/2"							BLE x PSE	MSS SP-95	ASTM A815 (UNS S31803)
N-E429		2" - 4"										
Gasket/Flanges	Socket Weld (SW)	F-300-JG	1/2" - 1 1/2"	According to pipe	Class 300	Raised Face	ASME B16.5	ASTM A182 Gr F51				
	Welding Neck (WN)	F-300-KG	2" - 24"									
	Blind	F-300-LG	1/2" - 24"									
Bolts & Nuts	Spiral-Wound	J-300-EL	1/2" - 24"	-	Class 300	Raised Face	ASME B16.20	Duplex/graphite				
	Stud and Nuts	P-300-07	1/2" - 1 1/2"	-	-	-	ASME B1.1	A193 B7, Zn-Ni				
A194 Gr 2H, Zn-Ni												



OFFSHORE PRODUCTION FACILITIES

Doc: I-ET-3010.1M-1200-200-P4X-001

Revision: F

Sheet: 2 of 2

PIPING SPECIFICATION FOR TOPSIDE

Material: Duplex

Class: 300

Standard: C16

Valves (see notes)

Type	Size	CODE	Temp	Type	Size	CODE	Temp	Type	Size	CODE	Temp	Type	Size	CODE	Temp
Needle	½" - 1 ½"	VAG-3000-1-D202	-46C to 150C			VES-300-1-D260	0C to 150C			VES-300-3-D216	-30C to 150C	Ball	6" - 24"	VES-300-4-D274	-46C to 150C
Butterfly	6" - 24"	VBO-300-2-D211	-46C to 150C	Ball	2" - 24"	VES-300-1-D270	-46C to 150C	Ball	2" - 24"	VES-300-3-D217	-30C to 150C	Double Ball	½" - 2"	VDE-300-2-D201	-30C to 150C
		VBO-300-2-D212				VES-300-2-D210	-30C to 150C			VES-300-3-D226	0C to 150C			VDE-300-2-D202	-46C to 150C
		VBO-300-2-D213				VES-300-2-D216	0C to 150C			VES-300-3-D227	-46C to 150C			VDE-300-2-D203	-46C to 150C
Ball	¾" - 1 ½"	VES-801-1-D201	-30C to 150C	Ball	2" - 24"	VES-300-2-D220	0C to 150C	Ball	2" - 24"	VES-300-3-D236	-46C to 150C	Gate	½" - 1 ½"	VGA-801-1-D201	-50C to 150C
		VES-801-1-D202	-46C to 150C			VES-300-2-D226	-46C to 150C			VES-300-3-D237	-46C to 150C			VGA-300-1-D201	-50C to 150C
		VES-801-1-D205	-46C to 150C			VES-300-2-D230	-46C to 150C			VES-300-3-D252	-30C to 150C			VGA-300-2-D201	-46C to 150C
		VES-801-2-D201	-30C to 150C			VES-300-2-D236	-30C to 150C			VES-300-3-D253	0C to 150C			VGL-300-1-D201	-46C to 150C
		VES-801-2-D202	-46C to 150C			VES-300-2-D250	0C to 150C			VES-300-3-D262	-46C to 150C			VGL-300-2-D201	-46C to 150C
	VES-801-2-D205	-46C to 150C	VES-300-2-D252			-30C to 150C	VES-300-3-D263			0C to 150C	VRE-800-1-D202	-46C to 150C			
	VES-801-3-D205	-46C to 150C	VES-300-2-D260			0C to 150C	VES-300-3-D272			-46C to 150C	VRE-300-1-D211	0C to 150C			
	2" - 24"	VES-300-1-D210	-30C to 150C			VES-300-2-D262	-46C to 150C			VES-300-3-D273	-46C to 150C	Check	2" - 24"	VRE-300-1-D212	-46C to 150C
		VES-300-1-D220	0C to 150C			VES-300-2-D270	-46C to 150C			VES-300-4-D254	-30C to 150C			VRE-300-2-D212	-46C to 150C
		VES-300-1-D230	-46C to 150C			VES-300-2-D272	-46C to 150C			VES-300-4-D264	0C to 150C			VRE-300-2-D215	-46C to 150C
		VES-300-1-D250	-30C to 150C												



Branch (see notes)

RUN SIZE	0.5	TEE															
	0.75	RTEE	TEE														
	1	RTEE	RTEE	TEE													
	1.5	RTEE	RTEE	RTEE	TEE												
	2	SOC	SOC	SOC	SOC	TEE											
	3	SOC	SOC	SOC	SOC	RTEE	TEE										
	4	SOC	SOC	SOC	SOC	RTEE	RTEE	TEE									
	6	SOC	SOC	SOC	SOC	WOL	RTEE	RTEE	TEE								
	8	SOC	SOC	SOC	SOC	WOL	WOL	RTEE	RTEE	TEE							
	10	SOC	SOC	SOC	SOC	WOL	WOL	WOL	RTEE	RTEE	TEE						
	12	SOC	SOC	SOC	SOC	WOL	WOL	WOL	RTEE	RTEE	RTEE	TEE					
	14	SOC	SOC	SOC	SOC	WOL	WOL	WOL	RTEE	RTEE	RTEE	TEE					
16	SOC	SOC	SOC	SOC	WOL	WOL	WOL	RTEE	RTEE	RTEE	RTEE	TEE					
18	SOC	SOC	SOC	SOC	WOL	WOL	WOL	WOL	RTEE	RTEE	RTEE	RTEE	TEE				
20	SOC	SOC	SOC	SOC	WOL	WOL	WOL	WOL	RTEE	RTEE	RTEE	RTEE	TEE				
24	SOC	SOC	SOC	SOC	WOL	WOL	WOL	WOL	RTEE	RTEE	RTEE	RTEE	TEE				
	0.5	0.75	1	1.5	2	3	4	6	8	10	12	14	16	18	20	24	

WOL - Weldolet
TEE - Tee
RTEE - Red Tee
HC - Half Coupling
SOC - Sockolet

Notes

1	On the spec valve list, it may have valves codes which contain values of process data lower than spec limits. It shall be verified all valve process data (e.g.: pressure, temperature) in order to specify it according the design premisses.
2	See Annex A for valves requirements and general selection criteria.
3	Bolts,nuts and gaskets (only RTJ gaskets) must be Zn-Ni coated according to Annex B.
4	See Annex C for instruments, drains and vents typical piping arrangement.
5	Flanges ≤ 1 1/2" may be used, if strictly necessary.
6	See Annex E for Isolation gasket specifications.
7	Welding and Welding Inspection activities shall follow the requeriments of these documents: I-ET-3010.00-1200-955-P4X-001-Welding and I-ET-3010.00-1200-955-P4X-002-Requirements for Welding Inspection
8	All valves, pipes and components specified for hydrogen sulfide service shall be in accordance with ISO 15156 requirements.
26	See Annex A for valve casting qualification requirements.
27	See Annex D to check the piping spec range application for H2S and CO2 service.
29	Duplex Stainless Steel external coating shall be applied for the temperature limits acc. to I-ET-3010.00-1200-956-P4X-002 - General Painting.
58	This spec for Amine service is applicable for piping downstream the booster pump.
82	Use this Spec after SG (free water separator).
120	Wafer valves are not to be used with flammable or combustible services, according to NFPA definition.
122	Inspection of pipe and piping components shall follow ASTM A923 requirements.
125	Materials shall follow the requirements of IOGP S-563- Material Data Sheets for Piping and Valve Components. Coating for bolts and nuts shall follow spec note number 3.

		OFFSHORE PRODUCTION FACILITIES				Doc: I-ET-3010.1M-1200-200- P4X-001	Revision: F	Sheet 1 of 2
		PIPING SPECIFICATION FOR TOPSIDE					Issued by: SRGE/ESUP	Code: ASME B31.3

Services (see notes): PC - Process (Corrosive Hydrocarbon);	Material: Low Temp CS	Class: 300	Standard: C19
--	-----------------------------	---------------	------------------

Pressure Rating (see notes)										
Temperature (°C)	-46	0	50	100	150	200				
Max Pressure (barg)	48	48	47.5	45.3	43.9	42.5				

Pipes and Fittings (see notes)

Items	Code	Size	Wall	Class	Ends	Standard	Material					
Pipes	T-105	1/2" - 1 1/2"	S-160	-	PE	ASME B36.10	ASTM A333 Gr 6 SML					
		2"	XS		BE							
		3" - 10"	STD									
		12" - 14"	S-40									
	T-106	16"	0.438"				-	BE	ASME B36.10	ASTM A671 Gr CC60 Class 22 WLD		
		18"	XS									
		20"	0.562"									
		24" - 26"	0.625"									
Fittings	90 Elbow	1/2" - 1 1/2"	-	6000	SW	ASME B16.11	ASTM A350 Gr LF2 Cl 1					
	45 Elbow											
	Tee											
	Cross											
	Coupling											
	Cap											
	Socketlet	3/4" - 1 1/2"	-	-	BE	ASME B16.11	ASTM A420 Gr WPL6					
	Red Tee											
	Red Coupling	2" - 30"	According to pipe	-	BE	ASME B16.9	ASTM A420 Gr WPL6					
	Weldolet											
	90 LR Elbow											
	45 LR Elbow											
	90 SR Elbow											
	Tee											
	Cap											
	Nipple	Conc. Red	3" - 30"	According to pipe	-	PBE	ASTM A733	ASTM A333 Gr 6				
Ecc. Red												
Red Tee		2" - 4"	According to pipe						-	BLE x PSE	MSS SP-95	ASTM A420 Gr WPL6
Straight Nipple												
Swage Conc Nipple												
Swage Ecc Nipple												
Flanges	Socket Weld (SW)	1/2" - 1 1/2"	According to pipe	Class 300	Raised Face	ASME B16.5	ASTM A350 Gr LF2 Class 1					
	Welding Neck (WN)											
	Blind											
Bolts & Gasket Nuts	Spiral-Wound	1/2" - 30"	-	Class 300	Raised Face	ASME B16.20	AISI 316/graphite					
	Stud and Nuts	P-300-07	1/2" - 1 1/2"	-	-	ASME B1.1	A193 B7, Zn-Ni A194 Gr 2H, Zn-Ni					



PETROBRAS

NP-1

OFFSHORE PRODUCTION FACILITIES

Doc: I-ET-3010.1M-1200-200-P4X-001

Revision: F

Sheet: 2 of 2

PIPING SPECIFICATION FOR TOPSIDE

Material: Low Temp CS

Class: 300

Standard: C19

Valves (see notes)



Type	Size	CODE	Temp	Type	Size	CODE	Temp	Type	Size	CODE	Temp	Type	Size	CODE	Temp				
Needle	1/2" - 1 1/2"	VAG-3000-1-S201	-100C to 200C	Ball	2" - 30"	VES-300-2-C210	-30C to 150C	Ball	2" - 30"	VES-300-3-C252	-30C to 150C	Globe	2" - 18"	VGL-300-1-C201	-46C to 345C				
		VAG-3000-1-S202	-100C to 400C			VES-300-2-C216	VES-300-3-C253			VGL-300-2-C201									
Butterfly	10" - 30"	VBO-300-3-C223	-46C to 240C			VES-300-2-C230	-46C to 150C			VES-300-3-C272	-46C to 200C	Plug	2" - 12"	VMA-300-2-C201	-30C to 93C	Check	2" - 30"	VRE-800-1-C202	-46C to 345C
		VES-803-1-C201	-30C to 150C			VES-300-2-C236	VES-300-3-C273			VRE-800-2-C202									
Ball	1/2" - 1 1/2"	VES-803-1-C205	-30C to 200C			VES-300-2-C270	-46C to 200C	VDE-300-2-C201	-30C to 150C	Double Ball	1/2" - 2"	VDE-300-2-C202	-30C to 150C	VRE-300-1-C211	0C to 150C				
		VES-803-2-C201	-30C to 150C			VES-300-3-C216	-30C to 150C	VDE-300-2-C205	-46C to 200C			VRE-300-2-C212	-46C to 345C						
		VES-803-2-C205	-46C to 200C	VES-300-3-C217	-30C to 150C	VDE-300-2-C206	-46C to 200C	VRE-300-2-C215	-46C to 345C										
	VES-803-3-C205	-30C to 200C	VES-300-3-C237	-46C to 150C	VDE-300-2-C215	-30C to 150C	VRE-300-2-C235	-46C to 210C											
	2" - 30"	VES-300-1-C210	-30C to 150C																
		VES-300-1-C230	-46C to 150C																

Branch (see notes)

RUN SIZE	0.5	TEE	WOL - Weldolet	
	0.75	RTEE TEE		
	1	RTEE RTEE TEE		
	1.5	RTEE RTEE RTEE TEE		
	2	SOC SOC SOC SOC TEE		TEE - Tee
	3	SOC SOC SOC SOC RTEE TEE		
	4	SOC SOC SOC SOC RTEE RTEE TEE		RTEE - Red Tee
	6	SOC SOC SOC SOC WOL RTEE RTEE TEE		
	8	SOC SOC SOC SOC WOL WOL RTEE RTEE TEE		HC - Half Coupling
	10	SOC SOC SOC SOC WOL WOL WOL RTEE RTEE TEE		
	12	SOC SOC SOC SOC WOL WOL WOL RTEE RTEE RTEE TEE		SOC - Sockolet
	14	SOC SOC SOC SOC WOL WOL WOL WOL RTEE RTEE RTEE TEE		
	16	SOC SOC SOC SOC WOL WOL WOL WOL RTEE RTEE RTEE RTEE TEE		
	18	SOC SOC SOC SOC WOL WOL WOL WOL WOL RTEE RTEE RTEE RTEE TEE		
	20	SOC SOC SOC SOC WOL WOL WOL WOL WOL RTEE RTEE RTEE RTEE TEE		
24	SOC SOC SOC SOC WOL WOL WOL WOL WOL WOL RTEE RTEE RTEE RTEE TEE			
26	SOC SOC SOC SOC WOL WOL WOL WOL WOL WOL RTEE RTEE RTEE RTEE TEE			
28	SOC SOC SOC SOC WOL WOL WOL WOL WOL WOL RTEE RTEE RTEE RTEE TEE			
30	SOC SOC SOC SOC WOL WOL WOL WOL WOL WOL RTEE RTEE RTEE RTEE TEE			
BRANCH SIZE				

Notes



- On the spec valve list, it may have valves codes which contain values of process data lower than spec limits. It shall be verified all valve process data (e.g.: pressure, temperature) in order to specify it according the design premisses.
- See Annex A for valves requirements and general selection criteria.
- Bolts,nuts and gaskets (only RTJ gaskets) must be Zn-Ni coated according to Annex B.
- See Annex C for instruments, drains and vents typical piping arrangement.
- Flanges ≤ 1 1/2" may be used, if strictly necessary .
- See Annex E for Isolation gasket specifications.
- Welding and Welding Inspection activities shall follow the requeriments of these documents: I-ET-3010.00-1200-955-P4X-001-Welding and I-ET-3010.00-1200-955-P4X-002-Requirements for Welding Inspection
- All valves, pipes and components specified for hydrogen sulfide service shall be in accordance with ISO 15156 requirements.
- Charpy impact test is required at the minimum temperature of this spec, according to ASME B31.3 and standard material specification.
- Wafer valves are not to be used with flammable or combustible services, according to NFPA definition.
- Materials shall follow the requirements of IOGP S-563- Material Data Sheets for Piping and Valve Components. Coating for bolts and nuts shall follow spec note number 3.

		OFFSHORE PRODUCTION FACILITIES				Doc: I-ET-3010.1M-1200-200- P4X-001	Revision: F	Sheet 1 of 2
		PIPING SPECIFICATION FOR TOPSIDE					Issued by: SRGE/ESUP	Code: ASME B31.3

Services (see notes): SW - Aerated Sea Water;	Material: FRP	Class: 25 bar	Standard: C23
--	------------------	------------------	------------------

Pressure Rating (see notes)									
Temperature (°C)	90								
Max Pressure (barg)	25								

Pipes and Fittings (see notes)								
	Items	Code	Size	Wall	Class	Ends	Standard	Material
Pipes	Pipe	T-410	1" - 28"	acc. manufact.	-	Bell-Spigot Butt-Strap	ISO 14692	FRP - Bisphenol A Epoxy resins reinforced with fiberglass type E or E-CR. Design pressure 25 bar@90°C. SML
	Plug	C09-36	1" - 1 1/2"		250	THD	ASME B16.15	ASTM B62 (UNS C83600)
Fittings	Thd Saddle	C52-64	1" - 6"		-			FRP - Bisphenol A Epoxy resins reinforced with fiberglass type E or E-CR. Design pressure 25bar@90°C
	Flg Saddle	C51-64	1" - 6"		-			
	Coupling	C06-64	1" - 28"	According to pipe	25 bar	Bell-Spigot	ISO 14692	
	90 LR Elbow	C15-64				-		
	45 LR Elbow	C16-64				Butt-Strap		
	Tee	C20-64				Bell-Spigot		
	FRP Stub End	C64-64		Butt-Strap				
	FRP Conc. Red.	C61-64	2" - 28"			Bell-Spigot		
	FRP Ecc. Red.	C62-64				Butt-Strap		
	Red Tee	C63-64				Bell-Spigot		
						Butt-Strap		
		Bell-Spigot						
Bolts & Gasket Flanges	Blind	F-25-LT	1" - 28"	According to pipe	25 bar	Raised Face		10005
	Backing Flange	F-25-YV					Drilling acc. B16.5/B16.47 CL300	ASTM A105 Epoxy coated
Bolts & Nuts	Flat type	J-300-P3	1" - 28"	-	Class 300	Raised Face	ASME B16.21	Neoprene
	Stud and Nuts	P-300-07	1/2" - 1 5/8"	-	-	-	ASME B1.1	A193 B7, Zn-Ni A194 Gr 2H, Zn-Ni

		OFFSHORE PRODUCTION FACILITIES				Doc: I-ET-3010.1M-1200-200- P4X-001	Revision: F	Sheet 1 of 2
		PIPING SPECIFICATION FOR TOPSIDE					Issued by: SRGE/ESUP	Code: ASME B31.3

Services (see notes): IW - De-Aerated Sea Water Injection; PC - Process (Corrosive Hydrocarbon); PCW - Produced water;	Material: CS Inconel Clad.	Class: 300	Standard: C30
---	----------------------------------	---------------	------------------

Pressure Rating (see notes)										
Temperature (°C)	-20	0	38	50	100	150	200			
Max Pressure (barg)	51.1	51.1	51.1	50.1	46.6	45.1	43.8			

Pipes and Fittings (see notes)

Items	Code	Size	Wall	Class	Ends	Standard	Material				
Pipes	T-203	1/2" - 1 1/2"	S-40S	-	PE	ASME B36.10/B36.19	ASTM B444 Gr 1 (UNS N06625) SML				
		2" - 3"	STD								
		4" - 6"	S-20								
		8"	0.279"								
	T-102	10"	0.312"								
		12"	0.344"								
		14"	0.406"								
		16"	S-30								
		18"	XS								
		20"	0.625"								
24"											
26"											
Fittings	90 Elbow	C01-33	-	3000	SW	ASME B16.11	ASTM B366 (UNS N06625)				
	45 Elbow	C02-33									
	Tee	C03-33									
	Cross	C05-33									
	Coupling	C06-33									
	Cap	C11-33									
	Socketlet	C55-33									
	Red Tee	C04-33									
	Red Coupling	C08-33									
	Weldolet	C12-33									
	90 LR Elbow	C15-33	According to pipe	-	BE	MSS SP-97					
	45 LR Elbow	C16-33			ASME B16.9	-					
	90 SR Elbow	C17-33				ASME B16.9					
	Tee	C20-33									
	Cap	C22-33									
	Cross	C24-33									
	Weldolet	C12-02					MSS SP-97	ASTM A105			
	Conc. Red	C18-33					According to pipe	-	BE	ASME B16.9	ASTM A234 Gr WPB
	Ecc. Red	C19-33									
	Red Tee	C21-33									
	90 LR Elbow	C15-03									
	45 LR Elbow	C16-03									
	90 SR Elbow	C17-03									
	Tee	C20-03									
	Cap	C22-03									
	Cross	C24-03									
	Conc. Red	C18-03									
	Ecc. Red	C19-03									
Red Tee	C21-03										
Nipple	Straight Nipple	N-S139	1/2" - 1 1/2"	According to pipe	-	PBE	ASTM A733	ASTM B444 Gr 1 (UNS N06625)			
	Swage Conc Nipple	N-C133	3/4" - 1 1/2"			BLE x PSE	MSS SP-95	ASTM B366 (UNS N06625)			
		N-C433	2" - 4"			PBE					
	Swage Ecc Nipple	N-E133	3/4" - 1 1/2"			BLE x PSE					
	N-E433	2" - 4"									
Flanges	Socket Weld (SW)	F-300-JL	1/2" - 1 1/2"	According to pipe	Class 300	Raised Face	ASME B16.5	ASTM B564 (UNS N06625)			
	Welding Neck (WN)	F-300-KL	2" - 3"					ASME B16.47 A	ASTM A105 Cladded		
		F-300-KB	4" - 24"								
	Blind	F-300-LL	1/2" - 3"						ASME B16.5	ASTM B564 (UNS N06625)	
		F-300-LB	4" - 24"							ASME B16.47 A	ASTM A105 Cladded
			26"								
		26"									
Gasket	Spiral-Wound	J-300-EM	1/2" - 26"	-	Class 300	Raised Face	ASME B16.20	Inconel/graphite			
Bolts & Nuts	Stud and Nuts	P-300-07	1/2" - 1 3/8"	-	-	-	ASME B1.1	A193 B7, Zn-Ni			
								A194 Gr 2H, Zn-Ni			

Valves (see notes)



Type	Size	CODE	Temp	Type	Size	CODE	Temp	Type	Size	CODE	Temp	Type	Size	CODE	Temp			
Needle	½" - 1 ½"	VAG-3000-1-N102	-100C to 400C			VES-300-1-C570	0C to 210C			VES-300-3-C526		Double Ball	½" - 2"	VDE-300-2-N105	-100C to 200C			
Ball	½" - 1 ½"	VES-801-1-N101	-30C to 150C	Ball	2" - 26"	VES-300-2-C510	-29C to 150C	Ball	2" - 26"	VES-300-3-C527	0C to 150C	Double Ball	3" - 8"	VDE-300-2-C514	-29C to 150C			
		VES-801-1-N102	-46C to 150C			VES-300-2-C520	VES-300-3-C536			2" - 20"			VGL-300-2-C501	-29C to 400C				
		VES-801-1-N105	-100C to 200C			VES-300-2-C526	VES-300-3-C537			Check			½" - 1 ½"	VRE-800-1-N102	-100C to 400C			
	VES-801-2-N101	-30C to 150C	VES-300-2-C530			VES-300-3-C553	2" - 26"					VRE-800-2-N102		-29C to 400C				
	VES-801-2-N102	-46C to 150C	VES-300-2-C536			VES-300-3-C562	4" - 26"					VRE-300-1-C512		-29C to 400C				
	VES-801-2-N105	-100C to 200C	VES-300-2-C560			VES-300-3-C563				VRE-300-2-C512		-29C to 400C						
	VES-801-3-N105	-100C to 200C	VES-300-2-C562			VES-300-3-C572		VRE-300-2-C515	-29C to 400C									
	2" - 26"	VES-300-1-C520	0C to 150C			VES-300-2-C570	0C to 210C	VES-300-2-C572	0C to 210C	VES-300-3-C573	0C to 210C	Double Ball	½" - 2"	-30C to 150C	VDE-300-2-N101	-30C to 150C	VRE-300-2-C535	-29C to 210C
		VES-300-1-C530	0C to 150C			VES-300-2-C572	VES-300-3-C572	VDE-300-2-N102	-30C to 150C									
		VES-300-1-C560	0C to 210C			VES-300-3-C517	-29C to 150C											

Branch (see notes)

RUN SIZE																																											
0.5	TEE																										WOL - Weldolet																
0.75	RTEE																																										
1	RTEE																										TEE - Tee																
1.5	RTEE																																										
2	SOC																										RTEE - Red Tee																
3	SOC																																										
4	SOC																										HC - Half Coupling																
6	SOC																																										
8	SOC																										SOC - Sockolet																
10	SOC																																										
12	SOC																																										
14	SOC																																										
16	SOC																																										
18	SOC																																										
20	SOC																																										
24	SOC																																										
26	SOC																																										
<table border="1" style="width:100%; border-collapse: collapse; font-size: 6px;"> <tr> <td>0.5</td><td>0.75</td><td>1</td><td>1.5</td><td>2</td><td>3</td><td>4</td><td>6</td><td>8</td><td>10</td><td>12</td><td>14</td><td>16</td><td>18</td><td>20</td><td>24</td><td>26</td> </tr> </table>																											0.5	0.75	1	1.5	2	3	4	6	8	10	12	14	16	18	20	24	26
0.5	0.75	1	1.5	2	3	4	6	8	10	12	14	16	18	20	24	26																											

Notes

1	On the spec valve list, it may have valves codes which contain values of process data lower than spec limits. It shall be verified all valve process data (e.g.: pressure, temperature) in order to specify it according the design premisses.
2	See Annex A for valves requirements and general selection criteria.
3	Bolts, nuts and gaskets (only RTJ gaskets) must be Zn-Ni coated according to Annex B.
4	See Annex C for instruments, drains and vents typical piping arrangement.
5	Flanges ≤ 1 1/2" may be used, if strictly necessary.
6	See Annex E for Isolation gasket specifications.
7	Welding and Welding Inspection activities shall follow the requirements of these documents: I-ET-3010.00-1200-955-P4X-001-Welding and I-ET-3010.00-1200-955-P4X-002-Requirements for Welding Inspection
8	All valves, pipes and components specified for hydrogen sulfide service shall be in accordance with ISO 15156 requirements.
9	Charpy impact test is required at the minimum temperature of this spec, according to ASME B31.3 and API 5L requirements. Applicable to both base material and WPS qualification.
27	See Annex D to check the piping spec range application for H2S and CO2 service.
42	Piping, fittings and accessories shall have internal Inconel® 625 cladding according to I-ET-3010.00-1200-955-P4X-001 - Welding.
103	Use this Spec after choke valve up to SG (free water separator).
120	Wafer valves are not to be used with flammable or combustible services, according to NFPA definition.
125	Materials shall follow the requirements of IOGP S-563- Material Data Sheets for Piping and Valve Components. Coating for bolts and nuts shall follow spec note number 3.

		OFFSHORE PRODUCTION FACILITIES				Doc: I-ET-3010.1M-1200-200- P4X-001	Revision: F	Sheet 1 of 2
		PIPING SPECIFICATION FOR TOPSIDE					Issued by: SRGE/ESUP	Code: ASME B31.3

Services (see notes): AM - Amine; CNI - Corrosive Chemical Injection (Except Sodium Hypochlorite); FG - Fuel Gas; G - Glycol; H - Hydraulic Fluid; P - Process (non-corrosive hydrocarbon); PC - Process (Corrosive Hydrocarbon);	Material: SS 316/316L	Class: 600	Standard: E3
--	-----------------------------	---------------	-----------------

Pressure Rating (see notes)										
Temperature (°C)	-100	38	50	100	150	200				
Max Pressure (barg)	99.3	99.3	96.2	84.4	77.0	71.3				

Pipes and Fittings (see notes)

Items		Code	Size	Wall	Class	Ends	Standard	Material					
Pipes	Pipe	T-322	1/2" - 1 1/2"	S-40S	-	PE	ASME B36.19	ASTM A312 TP 316/316L SML					
		T-323	2" - 8"			BE	ASME B36.10/B36.19	ASTM A358 Type 316/316L Cl 1 or 3 WLD					
			10" - 14"										
			16"	0.625"									
			18"	0.688"									
		20"	0.750"										
24"	0.875"												
Fittings	90 Elbow	C01-43	1/2" - 1 1/2"	-	3000	SW	ASME B16.11	ASTM A182 Gr F316/316L					
	45 Elbow	C02-43											
	Tee	C03-43											
	Cross	C05-43											
	Coupling	C06-43											
	Cap	C11-43											
	Socket	C55-43	3/4" - 1 1/2"	-	-	MSS SP-97	ASME B16.11	ASTM A403 Gr WP316/316L					
	Red Tee	C04-43											
	Red Coupling	C08-43											
	Weldolet	C12-43	2" - 10"	According to pipe	-	BE	ASME B16.9	ASTM A403 Gr WP316/316L					
	90 LR Elbow	C15-44											
	45 LR Elbow	C16-44											
	90 SR Elbow	C17-44											
	Tee	C20-44											
	Cap	C22-44											
	Cross	C24-44											
	Conc. Red	C18-44	3" - 24"						-	-	-	-	-
	Ecc. Red	C19-44											
Red Tee	C21-44												
Nipple	Straight Nipple	N-S145	1/2" - 1 1/2"						According to pipe	-	PBE	ASTM A733	ASTM A312 TP316/316L
	Swage Conc Nipple	N-C144	3/4" - 1 1/2"								BLE x PSE	MSS SP-95	ASTM A403 Gr WP316/316L
		N-C444	2" - 4"										
	Swage Ecc Nipple	N-E144	3/4" - 1 1/2"	2" - 4"	BLE x PSE	-	-						
N-E444		2" - 4"											
Flanges	Socket Weld (SW)	F-600-JX	1/2" - 1 1/2"	According to pipe	Class 600	Raised Face	ASME B16.5	ASTM A182 Gr F316/316L					
	Welding Neck (WN)	F-600-KX	2" - 24"			-	ISO 6162-1						
	Blind	F-350-4X	1/2" - 3"			Class 600	Raised Face		ASME B16.5				
		F-600-LX	1/2" - 24"			max 350 bar	-		ISO 6162-1				
	Hyd One-Piece Flange	F-350-3X	1/2" - 3"			max 350 bar	-		ISO 6162-1				
Bolts & Nuts	Spiral-Wound	J-600-EH	1/2" - 24"	-	Class 600	Raised Face	ASME B16.20	AISI 316/graphite					
	Stud and Nuts	P-600-08	1/2" - 1 1/2"	-	-	-	ASME B1.1	A320 L7, Zn-Ni A194 7L, Zn-Ni					



OFFSHORE PRODUCTION FACILITIES

Doc: I-ET-3010.1M-1200-200-P4X-001

Revision: F

Sheet: 2 of 2

PIPING SPECIFICATION FOR TOPSIDE

Material: SS 316/316L

Class: 600

Standard: E3

Valves (see notes)

Table with columns: Type, Size, CODE, Temp, Type, Size, CODE, Temp, Type, Size, CODE, Temp, Type, Size, CODE, Temp. Lists various valve types like Needle, Butterfly, Ball, Double Ball, Gate, Globe, Plug, and Check with their respective specifications.



Branch (see notes)

Branch size chart showing combinations of RUN SIZE (0.5 to 24) and BRANCH SIZE (0.5 to 24) with corresponding connection types like TEE, RTEE, SOC, WOL, etc.

WOL - Weldolet
TEE - Tee
RTEE - Red Tee
HC - Half Coupling
SOC - Sockolet

Notes

- 1 On the spec valve list, it may have valves codes which contain values of process data lower than spec limits. It shall be verified all valve process data (e.g.: pressure, temperature) in order to specify it according the design premisses.
2 See Annex A for valves requirements and general selection criteria.
3 Bolts,nuts and gaskets (only RTJ gaskets) must be Zn-Ni coated according to Annex B.
4 See Annex C for instruments, drains and vents typical piping arrangement.
5 Flanges ≤ 1 1/2" may be used, if strictly necessary .
6 See Annex E for Isolation gasket specifications.
7 Welding and Welding Inspection activities shall follow the requeriments of these documents: I-ET-3010.00-1200-955-P4X-001-Welding and I-ET-3010.00-1200-955-P4X-002-Requirements for Welding Inspection
8 All valves, pipes and components specified for hydrogen sulfide service shall be in accordance with ISO 15156 requirements.
51 Stainless Steel external coating shall be applied for the temperature limits acc. to I-ET-3010.00-1200-956-P4X-002 - General Painting.
55 This spec for FG service is applicable for piping downstream the filters.
59 In case of use this spec below -30 °C, the material shall be furnished with solution heat treatment.
120 Wafer valves are not to be used with flammable or combustible services, according to NFPA definition.
125 Materials shall follow the requirements of IOGP S-563- Material Data Sheets for Piping and Valve Components. Coating for bolts and nuts shall follow spec note number 3.
127 ISO 6162-1/2 flanges may be used only for H - Hydraulic Fluid.

		OFFSHORE PRODUCTION FACILITIES				Doc: I-ET-3010.1M-1200-200- P4X-001	Revision: F	Sheet 1 of 2
		PIPING SPECIFICATION FOR TOPSIDE					Issued by: SRGE/ESUP	Code: ASME B31.3

Services (see notes): FG - Fuel Gas; G - Glycol; GL - Refrigerated Liquefied Petroleum Gases in Low Temperature; P - Process (non-corrosive hydrocarbon);	Material: Low Temp CS	Class: 600	Standard: E6
--	-----------------------------	---------------	-----------------

Pressure Rating (see notes)

Temperature (°C)	-46	38	50	100	160	180					
Max Pressure (barg)	96	96	94.9	90.7	87.3	86.2					

Pipes and Fittings (see notes)

Items	Code	Size	Wall	Class	Ends	Standard	Material	
Pipes	T-105	1/2" - 1 1/2"	S-160	-	PE	ASME B36.10	ASTM A333 Gr 6 SML	
		2"	XS		BE			
		3"	STD					
		4"	0.250"					
		6"	0.344"					
		8"	0.438"					
		10"	XS					
		12" - 14"	0.625"					
	T-106	16" - 24"	S-60			ASTM A671 Gr CC60 Class 22 WLD		
Fittings	90 Elbow	C01-04	1/2" - 1 1/2"	-	6000	SW	ASTM A350 Gr LF2 Cl 1	
	45 Elbow	C02-04						
	Tee	C03-04						
	Cross	C05-04						
	Coupling	C06-04						
	Cap	C11-04						
	Socket	C55-04						
	Red Tee	C04-04						
	Red Coupling	C08-04	3/4" - 1 1/2"	According to pipe	-	BE	ASME B16.9	
	Weldolet	C12-04	2" - 10"					
	90 LR Elbow	C15-05	2" - 24"					
	45 LR Elbow	C16-05						
	90 SR Elbow	C17-05						
	Tee	C20-05						
	Cap	C22-05						
	Cross	C24-05						
	Conc. Red	C18-05	3" - 24"					
	Ecc. Red	C19-05						
Red Tee	C21-05							
Nipple	Straight Nipple	N-S137	1/2" - 1 1/2"	According to pipe	-	PBE	ASTM A733	ASTM A333 Gr 6
	Swage Conc Nipple	N-C105	3/4" - 1 1/2"			BLE x PSE	MSS SP-95	ASTM A420 Gr WPL6
	Swage Ecc Nipple	N-E105	3/4" - 1 1/2"					
		N-E405	2" - 4"					
Socket/Welding Neck/Blind	Socket Weld (SW)	F-600-J3	1/2" - 1 1/2"	According to pipe	Class 600	Raised Face	ASME B16.5	ASTM A350 Gr LF2 Class 1
	Welding Neck (WN)	F-600-K3	2" - 24"					
	Blind	F-600-L3	1/2" - 24"					
Gasket	Spiral-Wound	J-600-EH	1/2" - 24"	-	Class 600	Raised Face	ASME B16.20	AISI 316/graphite
	Bolts & Nuts	Stud and Nuts	P-600-07	1/2" - 1 7/8"	-	-	ASME B1.1	A193 B7, Zn-Ni
A194 Gr 2H, Zn-Ni								



OFFSHORE PRODUCTION FACILITIES

Doc:
I-ET-3010.1M-1200-200-P4X-001

Revision:
F

Sheet:
2 of 2

PIPING SPECIFICATION FOR TOPSIDE

Material:
Low Temp CS

Class:
600

Standard:
E6

Valves (see notes)



Type	Size	CODE	Temp	Type	Size	CODE	Temp	Type	Size	CODE	Temp	Type	Size	CODE	Temp			
Needle	1/2" - 1 1/2"	VAG-3000-1-S201	-100C to 200C	Ball	2" - 24"	VES-600-1-C214	-30C to 150C	Ball	2" - 24"	VES-600-3-C252	-30C to 150C	Double Ball	3" - 8"	VDE-600-2-C214	-30C to 150C			
		VAG-3000-1-S202	-100C to 400C			VES-600-1-C234	-46C to 150C			VES-600-3-C253				VDE-600-2-C215				
VES-803-1-C201	-30C to 150C	VES-600-2-C214	-30C to 150C			VES-600-3-C272	VDE-600-2-C234											
VES-803-1-C203	-30C to 120C	VES-600-2-C218	-46C to 200C			VES-600-3-C273	VDE-600-2-C235											
Ball	1/2" - 1 1/2"	VES-803-1-C205	-30C to 200C			VES-600-2-C234	-46C to 150C	VES-600-4-C254	-30C to 150C	Globe	2" - 4"	VGL-600-1-C201	-46C to 345C	Plug	2" - 24"	VMA-600-2-C201	-30C to 93C	
		VES-803-2-C201	-30C to 150C			VES-600-2-C238	-46C to 200C	VES-600-4-C274	-46C to 200C			VGL-600-2-C201				-46C to 345C		
		VES-803-2-C202	-46C to 150C			VES-600-2-C252	-30C to 150C	Double Ball	1/2" - 2"	VDE-600-2-C201	-30C to 150C	Check	2" - 14"	VRE-800-2-C202	-46C to 345C	2" - 24"	VRE-600-1-C211	0C to 150C
		VES-803-2-C203	-30C to 120C			VES-600-2-C270	-46C to 200C			VDE-600-2-C202	-46C to 150C			VRE-600-2-C212	-46C to 345C			
		VES-803-2-C205	-46C to 200C			VES-600-3-C218	-30C to 150C			VDE-600-2-C203	-46C to 150C	VRE-600-2-C215	-46C to 210C					
		VES-803-3-C201	-30C to 150C			VES-600-3-C219	-30C to 150C			VDE-600-2-C204	-46C to 150C	VRE-600-2-C212	-46C to 345C					
		VES-803-3-C202	-46C to 150C			VES-600-3-C238	-46C to 150C	VDE-600-2-C205	-46C to 200C	VRE-600-2-C215	-46C to 345C							
		VES-803-3-C205	-30C to 200C			VES-600-3-C239	-46C to 150C	VDE-600-2-C206	-46C to 200C	VRE-600-2-C235	-46C to 210C							

Branch (see notes)

RUN SIZE	BRANCH SIZE															Legend			
	0.5	0.75	1	1.5	2	3	4	6	8	10	12	14	16	18	20		24		
0.5	TEE																WOL - Weldolet		
0.75	RTEE	TEE															TEE - Tee		
1	RTEE	RTEE	TEE														RTEE - Red Tee		
1.5	RTEE	RTEE	RTEE	TEE													HC - Half Coupling		
2	SOC	SOC	SOC	SOC	TEE												SOC - Sockolet		
3	SOC	SOC	SOC	SOC	RTEE	TEE													
4	SOC	SOC	SOC	SOC	RTEE	RTEE	TEE												
6	SOC	SOC	SOC	SOC	WOL	RTEE	RTEE	TEE											
8	SOC	SOC	SOC	SOC	WOL	WOL	RTEE	RTEE	TEE										
10	SOC	SOC	SOC	SOC	WOL	WOL	WOL	RTEE	RTEE	TEE									
12	SOC	SOC	SOC	SOC	WOL	WOL	WOL	RTEE	RTEE	RTEE	TEE								
14	SOC	SOC	SOC	SOC	WOL	WOL	WOL	WOL	RTEE	RTEE	RTEE	TEE							
16	SOC	SOC	SOC	SOC	WOL	WOL	WOL	WOL	RTEE	RTEE	RTEE	RTEE	TEE						
18	SOC	SOC	SOC	SOC	WOL	WOL	WOL	WOL	WOL	RTEE	RTEE	RTEE	RTEE	TEE					
20	SOC	SOC	SOC	SOC	WOL	WOL	WOL	WOL	WOL	RTEE	RTEE	RTEE	RTEE	RTEE	TEE				
24	SOC	SOC	SOC	SOC	WOL	WOL	WOL	WOL	WOL	WOL	RTEE	RTEE	RTEE	RTEE	RTEE	TEE			

Notes

1	On the spec valve list, it may have valves codes which contain values of process data lower than spec limits. It shall be verified all valve process data (e.g.: pressure, temperature) in order to specify it according the design premisses.
2	See Annex A for valves requirements and general selection criteria.
3	Bolts,nuts and gaskets (only RTJ gaskets) must be Zn-Ni coated according to Annex B.
4	See Annex C for instruments, drains and vents typical piping arrangement.
5	Flanges ≤ 1 1/2" may be used, if strictly necessary.
6	See Annex E for Isolation gasket specifications.
7	Welding and Welding Inspection activities shall follow the requeriments of these documents: I-ET-3010.00-1200-955-P4X-001-Welding and I-ET-3010.00-1200-955-P4X-002-Requirements for Welding Inspection
8	All valves, pipes and components specified for hydrogen sulfide service shall be in accordance with ISO 15156 requirements.
25	Charpy impact test is required at the minimum temperature of this spec, according to ASME B31.3 and standard material specification.
120	Wafer valves are not to be used with flammable or combustible services, according to NFPA definition.
125	Materials shall follow the requirements of IOGP S-563- Material Data Sheets for Piping and Valve Components. Coating for bolts and nuts shall follow spec note number 3.



		OFFSHORE PRODUCTION FACILITIES				Doc: I-ET-3010.1M-1200-200- P4X-001	Revision: F	Sheet 1 of 2
		PIPING SPECIFICATION FOR TOPSIDE					Issued by: SRGE/ESUP	Code: ASME B31.3

Services (see notes): DO - Carbon Dioxide (DRY);	Material: Galv. CS	Class: 600	Standard: E8
---	-----------------------	---------------	-----------------

Pressure Rating (see notes)										
Temperature (°C)	-18	0	38	54						
Max Pressure (barg)	102.1	102.1	102.1	99.6						

Pipes and Fittings (see notes)

Items		Code	Size	Wall	Class	Ends	Standard	Material	
Pipes	Pipe	T-102	1/2" - 1 1/2"	XS	-	PE	ASME B36.10	API 5L Gr B PSL 1 SML	
			2" - 4"	STD		BE		API 5L Gr B PSL 1 (SML or WLD HFW or WLD SAW)	
			6"	0.312"					
			8"	S-60					
Fittings	90 Elbow	C01-02	1/2" - 1 1/2"	-	3000	SW	ASME B16.11	ASTM A105	
	45 Elbow	C02-02							
	Tee	C03-02							
	Cross	C05-02							
	Coupling	C06-02							
	Union	C10-02							
	Cap	C11-02							
	Socket	C55-02	MSS SP-97						
	Red Tee	C04-02							
	Red Coupling	C08-02							
	Weldolet	C12-02	1" - 3"	According to pipe	-	BE	MSS SP-97	ASTM A234 Gr WPB	
	90 LR Elbow	C15-03	2" - 8"			-	BE		ASME B16.9
	45 LR Elbow	C16-03							
	90 SR Elbow	C17-03							
	Tee	C20-03							
	Cap	C22-03							
	Cross	C24-03							
	Conc. Red	C18-03							
Ecc. Red	C19-03	3" - 8"	-			-	-		
Red Tee	C21-03								
Nipple	Straight Nipple	N-S120	1/2" - 1 1/2"	According to pipe	-	PBE	ASTM A733	API 5L Gr B PSL 1 seamless	
	Swage Conc Nipple	N-C103	3/4" - 1 1/2"			BLE x PSE	MSS SP-95	ASTM A234 Gr WPB	
		N-C403	2" - 4"						
	Swage Ecc Nipple	N-E103	3/4" - 1 1/2"			2" - 4"	-	-	-
N-E403		2" - 4"							
Gasket/Flanges	Welding Neck (WN)	F-600-K2	1/2" - 8"	According to pipe	Class 600	Raised Face	ASME B16.5	ASTM A105	
	Blind	F-600-L2							
Gasket/Flanges	Spiral-Wound	J-600-EH	1/2" - 8"	-	Class 600	Raised Face	ASME B16.20	AISI 316/graphite	
	Bolts & Nuts	Stud and Nuts	P-600-07	1/2" - 1 1/8"	-	-	-	ASME B1.1	A193 B7, Zn-Ni
A194 Gr 2H, Zn-Ni									

		OFFSHORE PRODUCTION FACILITIES			Doc: I-ET-3010.1M-1200-200-P4X-001	Revision: F	Sheet: 2 of 2
		PIPING SPECIFICATION FOR TOPSIDE				Material: Galv. CS	Class: 600

Valves (see notes)

Type	Size	CODE	Temp	Type	Size	CODE	Temp	Type	Size	CODE	Temp	Type	Size	CODE	Temp
Ball	1/2" - 1 1/2"	VES-800-1-C103 VES-800-2-C103	-29C to 120C	Check	1/2" - 1 1/2"	VRE-800-1-C102	-29C to 400C	Check	2" - 4"	VRE-600-1-C111	0C to 150C	Check	2" - 8"	VRE-600-2-C112	-29C to 400C



Branch (see notes)

RUN SIZE	0.5	TEE	0.75	RTEE	TEE	1	RTEE	RTEE	TEE	1.5	RTEE	RTEE	RTEE	TEE	2	SOC	SOC	SOC	SOC	TEE	3	SOC	SOC	SOC	SOC	RTEE	TEE	4	SOC	SOC	SOC	SOC	RTEE	RTEE	TEE	6	SOC	SOC	SOC	SOC	WOL	RTEE	RTEE	TEE	8	SOC	SOC	SOC	SOC	WOL	WOL	RTEE	RTEE	TEE
	0.5	0.75	1	1.5	2	3	4	6	8	BRANCH SIZE																																												

- WOL - Weldolet
- TEE - Tee
- RTEE - Red Tee
- HC - Half Coupling
- SOC - Sockolet

Notes

1	On the spec valve list, it may have valves codes which contain values of process data lower than spec limits. It shall be verified all valve process data (e.g.: pressure, temperature) in order to specify it according the design premisses.
2	See Annex A for valves requirements and general selection criteria.
3	Bolts,nuts and gaskets (only RTJ gaskets) must be Zn-Ni coated according to Annex B.
4	See Annex C for instruments, drains and vents typical piping arrangement.
5	Flanges ≤ 1 1/2" may be used, if strictly necessary.
6	See Annex E for Isolation gasket specifications.
7	Welding and Welding Inspection activities shall follow the requeriments of these documents: I-ET-3010.00-1200-955-P4X-001-Welding and I-ET-3010.00-1200-955-P4X-002-Requirements for Welding Inspection
9	Charpy impact test is required at the minimum temperature of this spec, according to ASME B31.3 and API 5L requirements. Applicable to both base material and WPS qualification.
52	Piping, fittings and accessories must be galvanized after spool fabrication according to ASTM A123 with minimum coating thickness of 100µm.
63	From -18°C to 0°C, API 5L gr B shall be furnished normalized.
68	This Spec shall be applied for distribution system of CO2, after directional valves.
125	Materials shall follow the requirements of IOGP S-563- Material Data Sheets for Piping and Valve Components. Coating for bolts and nuts shall follow spec note number 3.

		OFFSHORE PRODUCTION FACILITIES				Doc: I-ET-3010.1M-1200-200- P4X-001	Revision: F	Sheet 1 of 2
		PIPING SPECIFICATION FOR TOPSIDE						Issued by: SRGE/ESUP

Services (see notes): PC - Process (Corrosive Hydrocarbon);	Material: Carbon Steel	Class: 600	Standard: E9
--	---------------------------	---------------	-----------------

Pressure Rating (see notes)										
Temperature (°C)	0	38	50	100	150					
Max Pressure (barg)	102.1	102.1	100.2	93.2	90.2					

Pipes and Fittings (see notes)

Items		Code	Size	Wall	Class	Ends	Standard	Material	
Pipes	Pipe	T-102	1/2" - 1 1/2"	S-160	-	PE	ASME B36.10	API 5L Gr B PSL 1 SML	
		T-107	2"			XS		BE	API 5L Gr X65 PSL 2 (SML or WLD SAW)
			3" - 4"			0.375"			
			6"	XS					
			8" - 10"	S-80					
			12"	0.625"					
			14"	0.688"					
		16"	S-60	API 5L Gr X65 PSL 2 WLD SAW					
18" - 20"									
Fittings	90 Elbow	C01-02	1/2" - 1 1/2"	-	6000	SW	ASME B16.11	ASTM A105	
	45 Elbow	C02-02							
	Tee	C03-02							
	Cross	C05-02							
	Coupling	C06-02							
	Cap	C11-02							
	Socketlet	C55-02							
	Red Tee	C04-02	3/4" - 1 1/2"	-	-	MSS SP-97	ASTM A694 Gr F65		
	Red Coupling	C08-02							
	Weldolet	C12-22							
	90 LR Elbow	C15-22	2" - 20"	According to pipe	-	BE	MSS SP-75	ASTM A860 WPHY65	
	45 LR Elbow	C16-22							
	90 SR Elbow	C17-22							
	Tee	C20-22							
	Cap	C22-22							
	Cross	C24-22							
	Conc. Red	C18-22							
	Ecc. Red	C19-22	3" - 20"	-	-	-	-	-	
Red Tee	C21-22								
Nipple	Straight Nipple	N-S120	1/2" - 1 1/2"	According to pipe	-	PBE	ASTM A733	API 5L Gr B PSL 1 seamless	
	Swage Conc Nipple	N-C103	3/4" - 1 1/2"			BLE x PSE	MSS SP-95	ASTM A234 Gr WPB	
		N-C422	2" - 4"						
	Swage Ecc Nipple	N-E103	3/4" - 1 1/2"			PBE	-	ASTM A860 WPHY65	
		N-E422	2" - 4"						
Flanges	Socket Weld (SW)	F-600-J2	1/2" - 1 1/2"	According to pipe	Class 600	Raised Face	ASME B16.5	ASTM A105	
	Welding Neck (WN)	F-600-KC	2" - 20"					ASTM A694 Gr F65	
	Blind	F-600-L2	1/2" - 1 1/2"					ASTM A105	
		F-600-LC	2" - 20"					ASTM A694 Gr F65	
Gasket	Spiral-Wound	J-600-EH	1/2" - 20"	-	Class 600	Raised Face	ASME B16.20	AISI 316/graphite	
	Bolts & Nuts	Stud and Nuts	P-600-07	1/2" - 1 5/8"	-	-	-	ASME B1.1	A193 B7, Zn-Ni
A194 Gr 2H, Zn-Ni									

Valves (see notes)

Type	Size	CODE	Temp	Type	Size	CODE	Temp	Type	Size	CODE	Temp	Type	Size	CODE	Temp
Needle	1/2" - 1 1/2"	VAG-3000-1-S201	-100C to 200C	Ball	2" - 20"	VES-600-2-C134	0C to 150C	Ball	2" - 20"	VES-600-3-C162	0C to 210C	Double Ball	3" - 8"	VDE-600-2-C115	-29C to 150C
		VAG-3000-1-S202	-100C to 400C			VES-600-2-C138				VES-600-3-C163				VDE-600-2-C134	0C to 150C
VES-803-1-C103	0C to 120C	VES-600-2-C150	VES-600-3-C172			VDE-600-2-C135									
VES-803-1-C105	0C to 210C	VES-600-2-C152	VES-600-3-C173			VGA-801-1-C101				-29C to 400C					
VES-803-2-C103	0C to 120C	VES-600-2-C162	VES-600-4-C154			VGA-600-1-C131									
VES-803-2-C105	0C to 210C	VES-600-2-C170	VES-600-4-C164			VGA-600-2-C131									
VES-803-3-C105	0C to 210C	VES-600-2-C172	VES-600-4-C174			VGL-600-1-C101	-29C to 400C								
VES-600-1-C114	-29C to 150C	VES-600-3-C118	VDE-600-2-C201			VGL-600-2-C101									
VES-600-1-C134	0C to 150C	VES-600-3-C119	VDE-600-2-C202			VMA-600-2-C101	0C to 93C								
VES-600-1-C150	0C to 150C	VES-600-3-C128	VDE-600-2-C203			VRE-600-1-C111	0C to 150C								
VES-600-1-C170	0C to 210C	VES-600-3-C138	VDE-600-2-C204			VRE-600-2-C112	-29C to 400C								
VES-600-2-C114	-29C to 150C	VES-600-3-C139	VDE-600-2-C205			VRE-600-2-C115									
VES-600-2-C118	-29C to 150C	VES-600-3-C152	VDE-600-2-C206			VRE-600-2-C135	-29C to 210C								
VES-600-2-C128	0C to 150C	VES-600-3-C153	VDE-600-2-C114												



Branch (see notes)

0.5	TEE													
0.75	RTEE TEE													
1	RTEE RTEE TEE													
1.5	RTEE RTEE RTEE TEE													
2	SOC SOC SOC SOC TEE													
3	SOC SOC SOC SOC RTEE TEE													
4	SOC SOC SOC SOC RTEE RTEE TEE													
6	SOC SOC SOC SOC WOL RTEE RTEE TEE													
8	SOC SOC SOC SOC WOL WOL RTEE RTEE TEE													
10	SOC SOC SOC SOC WOL WOL WOL RTEE RTEE TEE													
12	SOC SOC SOC SOC WOL WOL WOL RTEE RTEE RTEE TEE													
14	SOC SOC SOC SOC WOL WOL WOL WOL RTEE RTEE RTEE TEE													
16	SOC SOC SOC SOC WOL WOL WOL WOL RTEE RTEE RTEE RTEE TEE													
18	SOC SOC SOC SOC WOL WOL WOL WOL RTEE RTEE RTEE RTEE TEE													
20	SOC SOC SOC SOC WOL WOL WOL WOL RTEE RTEE RTEE RTEE TEE													
0.5	0.75	1	1.5	2	3	4	6	8	10	12	14	16	18	20

WOL - Weldolet
 TEE - Tee
 RTEE - Red Tee
 HC - Half Coupling
 SOC - Sockolet

Notes

1	On the spec valve list, it may have valves codes which contain values of process data lower than spec limits. It shall be verified all valve process data (e.g.: pressure, temperature) in order to specify it according the design premisses.
2	See Annex A for valves requirements and general selection criteria.
3	Bolts, nuts and gaskets (only RTJ gaskets) must be Zn-Ni coated according to Annex B.
4	See Annex C for instruments, drains and vents typical piping arrangement.
5	Flanges ≤ 1 1/2" may be used, if strictly necessary.
6	See Annex E for Isolation gasket specifications.
7	Welding and Welding Inspection activities shall follow the requirements of these documents: I-ET-3010.00-1200-955-P4X-001-Welding and I-ET-3010.00-1200-955-P4X-002-Requirements for Welding Inspection
8	All valves, pipes and components specified for hydrogen sulfide service shall be in accordance with ISO 15156 requirements.
11	For API 5L pipe the maximum carbon equivalent is CE _{iw} = 0,43% or CE _{pcm} = 0,25%.
120	Wafer valves are not to be used with flammable or combustible services, according to NFPA definition.
125	Materials shall follow the requirements of IOGP S-563- Material Data Sheets for Piping and Valve Components. Coating for bolts and nuts shall follow spec note number 3.



		OFFSHORE PRODUCTION FACILITIES				Doc: I-ET-3010.1M-1200-200- P4X-001	Revision: F	Sheet 1 of 2
		PIPING SPECIFICATION FOR TOPSIDE					Issued by: SRGE/ESUP	Code: ASME B31.3

Services (see notes): AM - Amine; BG - Inert Gas; CI - Chemical Injection (non-corrosive); FG - Fuel Gas; G - Glycol; IW - De-Aerated Sea Water Injection; P - Process (non-corrosive hydrocarbon); W - Industrial water;	Material: Carbon Steel	Class: 600	Standard: E10
--	----------------------------------	----------------------	-------------------------

Pressure Rating (see notes)										
Temperature (°C)	-20	0	38	50	100	150	200	210		
Max Pressure (barg)	102.1	102.1	102.1	100.2	93.2	90.2	87.6	86.8		

Pipes and Fittings (see notes)

Items	Code	Size	Wall	Class	Ends	Standard	Material					
Pipes	T-102	1/2" - 1 1/2"	S-160	-	PE	ASME B36.10	API 5L Gr B PSL 1 SML					
		2" - 4"	STD		BE		API 5L Gr X65 PSL 2 (SML or WLD SAW)					
	T-107	6"	0.312"									
		8"	0.375"									
		10"	0.438"									
		12"	XS									
		14"	0.562"									
		16"	0.625"									
		18"	0.688"									
		20"	0.750"									
24"	0.875"	API 5L Gr X65 PSL 2 WLD SAW										
Fittings	90 Elbow	C01-02	-	6000	SW	ASME B16.11	ASTM A105					
	45 Elbow	C02-02										
	Tee	C03-02										
	Cross	C05-02										
	Coupling	C06-02										
	Cap	C11-02										
	Sockolet	C55-02										
	Red Tee	C04-02										
	Red Coupling	C08-02										
	Weldolet	C12-22						3/4" - 1 1/2"				
	90 LR Elbow	C15-22										
	45 LR Elbow	C16-22						2" - 24"	According to pipe	-	MSS SP-97	ASTM A694 Gr F65
	90 SR Elbow	C17-22										
	Tee	C20-22										
	Cap	C22-22										
	Cross	C24-22										
	Conc. Red	C18-22										
	Ecc. Red	C19-22										
Red Tee	C21-22											
Nipple	Straight Nipple	N-S120	1/2" - 1 1/2"	According to pipe	-	PBE	ASTM A733	API 5L Gr B PSL 1 seamless				
	Swage Conc Nipple	N-C103	3/4" - 1 1/2"			BLE x PSE	MSS SP-95	ASTM A234 Gr WPB				
		N-C422	2" - 4"									
	Swage Ecc Nipple	N-E103	3/4" - 1 1/2"			2" - 4"	BLE x PSE	MSS SP-95	ASTM A234 Gr WPB			
		N-E422	2" - 4"									
	Flanges	Socket Weld (SW)	F-600-J2			1/2" - 1 1/2"	According to pipe	Class 600	Raised Face	ASME B16.5	ASTM A105	
Welding Neck (WN)		F-600-KC	2" - 24"	ASTM A694 Gr F65								
Blind		F-600-L2	1/2" - 1 1/2"	ASTM A105								
		F-600-LC	2" - 24"	ASTM A694 Gr F65								
Gasket	Spiral-Wound	J-600-EH	1/2" - 24"	-	Class 600	Raised Face	ASME B16.20	AISI 316/graphite				
Bolts & Nuts	Stud and Nuts	P-600-07	1/2" - 1 1/8"	-	-	-	ASME B1.1	A193 B7, Zn-Ni				
								A194 Gr 2H, Zn-Ni				



		OFFSHORE PRODUCTION FACILITIES				Doc: I-ET-3010.1M-1200-200- P4X-001	Revision: F	Sheet 1 of 2
		PIPING SPECIFICATION FOR TOPSIDE					Issued by: SRGE/ESUP	Code: ASME B31.3

Services (see notes): AM - Amine; PC - Process (Corrosive Hydrocarbon);	Material: Duplex	Class: 600	Standard: E16
--	---------------------	---------------	------------------

Pressure Rating (see notes)										
Temperature (°C)	-46	0	38	50	100	130				
Max Pressure (barg)	103.4	103.4	103.4	103.4	101.3	95.6				

Pipes and Fittings (see notes)

Items		Code	Size	Wall	Class	Ends	Standard	Material						
Pipes	Pipe	T-301	1/2" - 1 1/2"	S-40S	-	PE	ASME B36.10/B36.19	ASTM A790 (UNS S31803) SML						
			2" - 3"	S-10S		BE								
			4" - 8"	S-40S										
		T-302	10" - 14"	S-80S					ASTM A928 (UNS S31803 Cl 1 or 3) WLD					
Fittings	90 Elbow	C01-27	1/2" - 1 1/2"	-	3000	SW	ASME B16.11	ASTM A182 Gr F51 (UNS S31803)						
	45 Elbow	C02-27												
	Tee	C03-27												
	Cross	C05-27												
	Coupling	C06-27												
	Cap	C11-27												
	Socketlet	C55-27	3/4" - 1 1/2"	-	-	-	ASME B16.11	-						
	Red Tee	C04-27												
	Red Coupling	C08-27												
	Weldolet	C12-27	2" - 6"	According to pipe	-	-	BE	ASME B16.9	ASTM A815 (UNS S31803)					
	90 LR Elbow	C15-29												
	45 LR Elbow	C16-29												
	90 SR Elbow	C17-29												
	Tee	C20-29												
	Cap	C22-29												
	Cross	C24-29												
	Conc. Red	C18-29												
	Ecc. Red	C19-29												
Red Tee	C21-29													
Nipple	Straight Nipple	N-S128	1/2" - 1 1/2"							According to pipe	-	PBE	ASTM A733	ASTM A790 (UNS S31803)
	Swage Conc Nipple	N-C129	3/4" - 1 1/2"											
		N-C429	2" - 4"											
	Swage Ecc Nipple	N-E129	3/4" - 1 1/2"											
N-E429		2" - 4"												
Gasket/Flanges	Socket Weld (SW)	F-600-JG	1/2" - 1 1/2"	According to pipe	Class 600	Raised Face	ASME B16.5	ASTM A182 Gr F51						
	Welding Neck (WN)	F-600-KG	2" - 16"											
	Blind	F-600-LG	1/2" - 16"											
Bolts & Nuts	Spiral-Wound	J-600-EL	1/2" - 16"	-	Class 600	Raised Face	ASME B16.20	Duplex/graphite						
	Stud and Nuts	P-600-07	1/2" - 1 1/2"	-	-	-	ASME B1.1	A193 B7, Zn-Ni A194 Gr 2H, Zn-Ni						

		OFFSHORE PRODUCTION FACILITIES		Doc: I-ET-3010.1M-1200-200-P4X-001	Revision: F	Sheet: 2 of 2
		PIPING SPECIFICATION FOR TOPSIDE			Material: Duplex	Class: 600

Valves (see notes)

Type	Size	CODE	Temp	Type	Size	CODE	Temp	Type	Size	CODE	Temp	Type	Size	CODE	Temp
Needle	1/2" - 1 1/2"	VAG-3000-1-D202	-46C to 150C			VES-600-1-D224	0C to 150C			VES-600-3-D239	-46C to 150C			VDE-600-2-D224	0C to 150C
Butterfly	6" - 16"	VBO-600-3-D223	-46C to 150C			VES-600-1-D234	-46C to 150C			VES-600-3-D252	-30C to 150C	Double Ball	3" - 8"	VDE-600-2-D225	
		VES-801-1-D201	-30C to 150C			VES-600-2-D214	-30C to 150C			VES-600-3-D253	-30C to 150C			VDE-600-2-D234	-46C to 150C
		VES-801-1-D202	-46C to 150C			VES-600-2-D218	-30C to 150C			VES-600-3-D262	0C to 150C			VDE-600-2-D235	-46C to 150C
		VES-801-1-D203	-30C to 120C			VES-600-2-D224	0C to 150C			VES-600-3-D263	0C to 150C			VGA-801-1-D201	-50C to 150C
		VES-801-1-D204	-46C to 150C			VES-600-2-D228	0C to 150C			VES-600-3-D272	-46C to 150C	Gate	1/2" - 1 1/2"	VGA-600-1-D231	-50C to 150C
		VES-801-1-D205	-46C to 150C			VES-600-2-D234	-46C to 150C			VES-600-3-D273	-46C to 150C		2" - 16"	VGL-600-1-D201	-46C to 150C
		VES-801-2-D201	-30C to 150C			VES-600-2-D238	-46C to 150C			VDE-600-2-D201	-30C to 150C	Globe	2" - 4"	VGL-600-2-D201	-46C to 150C
		VES-801-2-D202	-46C to 150C			VES-600-3-D218	-30C to 150C			VDE-600-2-D202	-30C to 150C		2" - 12"	VGL-600-2-D202	-46C to 150C
		VES-801-2-D203	-30C to 120C			VES-600-3-D219	-30C to 150C			VDE-600-2-D203	-46C to 150C		1/2" - 1 1/2"	VRE-800-1-D202	-46C to 150C
		VES-801-2-D204	-46C to 150C			VES-600-3-D228	0C to 150C			VDE-600-2-D204	-46C to 150C		2" - 4"	VRE-600-1-D211	0C to 150C
		VES-801-2-D205	-46C to 150C			VES-600-3-D229	0C to 150C			VDE-600-2-D214	-30C to 150C		2" - 16"	VRE-600-2-D212	-46C to 150C
		VES-801-3-D205	-46C to 150C			VES-600-3-D238	-46C to 150C			VDE-600-2-D215	-30C to 150C		4" - 12"	VRE-600-2-D215	-46C to 150C
		VES-801-3-D205	-46C to 150C											VRE-600-2-D235	-46C to 150C
	2" - 16"	VES-600-1-D214	-30C to 150C												



Branch (see notes)

RUN SIZE	0.5	TEE																	
	0.75	RTEE	TEE																
	1	RTEE	RTEE	TEE															
	1.5	RTEE	RTEE	RTEE	TEE														
	2	SOC	SOC	SOC	SOC	TEE													
	3	SOC	SOC	SOC	SOC	RTEE	TEE												
	4	SOC	SOC	SOC	SOC	RTEE	RTEE	TEE											
	6	SOC	SOC	SOC	SOC	WOL	RTEE	RTEE	TEE										
	8	SOC	SOC	SOC	SOC	WOL	WOL	RTEE	RTEE	TEE									
	10	SOC	SOC	SOC	SOC	WOL	WOL	WOL	RTEE	RTEE	TEE								
	12	SOC	SOC	SOC	SOC	WOL	WOL	WOL	RTEE	RTEE	RTEE	TEE							
	14	SOC	SOC	SOC	SOC	WOL	WOL	WOL	RTEE	RTEE	RTEE	TEE							
	16	SOC	SOC	SOC	SOC	WOL	WOL	WOL	RTEE	RTEE	RTEE	RTEE	TEE						
		0.5	0.75	1	1.5	2	3	4	6	8	10	12	14	16					

WOL - Weldolet
 TEE - Tee
 RTEE - Red Tee
 HC - Half Coupling
 SOC - Sockolet

Notes

1	On the spec valve list, it may have valves codes which contain values of process data lower than spec limits. It shall be verified all valve process data (e.g.: pressure, temperature) in order to specify it according the design premisses.
2	See Annex A for valves requirements and general selection criteria.
3	Bolts,nuts and gaskets (only RTJ gaskets) must be Zn-Ni coated according to Annex B.
4	See Annex C for instruments, drains and vents typical piping arrangement.
5	Flanges ≤ 1 1/2" may be used, if strictly necessary.
6	See Annex E for Isolation gasket specifications.
7	Welding and Welding Inspection activities shall follow the requeriments of these documents: I-ET-3010.00-1200-955-P4X-001-Welding and I-ET-3010.00-1200-955-P4X-002-Requirements for Welding Inspection
8	All valves, pipes and components specified for hydrogen sulfide service shall be in accordance with ISO 15156 requirements.
26	See Annex A for valve casting qualification requirements.
27	See Annex D to check the piping spec range application for H2S and CO2 service.
29	Duplex Stainless Steel external coating shall be applied for the temperature limits acc. to I-ET-3010.00-1200-956-P4X-002 - General Painting.
49	This spec for Amine service is applicable for piping downstream the Amine Contactor.
120	Wafer valves are not to be used with flammable or combustible services, according to NFPA definition.
122	Inspection of pipe and piping components shall follow ASTM A923 requirements.
125	Materials shall follow the requirements of IOGP S-563- Material Data Sheets for Piping and Valve Components. Coating for bolts and nuts shall follow spec note number 3.



		OFFSHORE PRODUCTION FACILITIES				Doc: I-ET-3010.1M-1200-200- P4X-001	Revision: F	Sheet 1 of 2
		PIPING SPECIFICATION FOR TOPSIDE					Issued by: SRGE/ESUP	Code: ASME B31.3

Services (see notes): PC - Process (Corrosive Hydrocarbon);	Material: Low Temp CS	Class: 600	Standard: E19
--	-----------------------------	---------------	------------------

Pressure Rating (see notes)										
Temperature (°C)	-46	38	50	100	160	180				
Max Pressure (barg)	96	96	94.9	90.7	87.3	86.2				

Pipes and Fittings (see notes)

Items	Code	Size	Wall	Class	Ends	Standard	Material	
Pipes	T-105	1/2" - 1 1/2"	S-160	-	PE	ASME B36.10	ASTM A333 Gr 6 SML	
		2"	0.250"		BE			
		3" - 8"	XS					
		10" - 12"	S-80					
		14"	0.688"					
	T-106	16"	S-60				ASTM A671 Gr CC60 Class 22 WLD	
		18"	0.875"					
		20"	S-60					
		24"	S-60					
Fittings	90 Elbow	C01-04	1/2" - 1 1/2"	-	6000	SW	ASTM A350 Gr LF2 Cl 1	
	45 Elbow	C02-04						
	Tee	C03-04						
	Cross	C05-04						
	Coupling	C06-04						
	Cap	C11-04						
	Socket	C55-04						
	Red Tee	C04-04						
	Red Coupling	C08-04	3/4" - 1 1/2"	-	-	BE	ASME B16.11	
		Weldolet	C12-04					
	90 LR Elbow	C15-05	2" - 24"	According to pipe	-	BE	ASME B16.9	
	45 LR Elbow	C16-05						
	90 SR Elbow	C17-05						
	Tee	C20-05						
	Cap	C22-05						
	Cross	C24-05						
	Conc. Red	C18-05						
	Ecc. Red	C19-05						
Red Tee	C21-05	3" - 24"						
Nipple	Straight Nipple	N-S137	1/2" - 1 1/2"	According to pipe	-	PBE	ASTM A733	ASTM A333 Gr 6
	Swage Conc Nipple	N-C105	3/4" - 1 1/2"			BLE x PSE	MSS SP-95	ASTM A420 Gr WPL6
		N-C405	2" - 4"					
	Swage Ecc Nipple	N-E105	3/4" - 1 1/2"			PBE		
		N-E405	2" - 4"				BLE x PSE	
Socket/Welding Neck/Blind Flanges	Socket Weld (SW)	F-600-J3	1/2" - 1 1/2"	According to pipe	Class 600	Raised Face	ASME B16.5	ASTM A350 Gr LF2 Class 1
	Welding Neck (WN)	F-600-K3	2" - 24"					
	Blind	F-600-L3	1/2" - 24"					
Gasket	Spiral-Wound	J-600-EH	1/2" - 24"	-	Class 600	Raised Face	ASME B16.20	AISI 316/graphite
Bolts & Nuts	Stud and Nuts	P-600-07	1/2" - 1 3/8"	-	-	-	ASME B1.1	A193 B7, Zn-Ni
								A194 Gr 2H, Zn-Ni



		OFFSHORE PRODUCTION FACILITIES				Doc: I-ET-3010.1M-1200-200- P4X-001	Revision: F	Sheet 1 of 2
		PIPING SPECIFICATION FOR TOPSIDE					Issued by: SRGE/ESUP	Code: ASME B31.3

Services (see notes): PC - Process (Corrosive Hydrocarbon);	Material: CS Inconel Clad.	Class: 600	Standard: E30
--	----------------------------------	---------------	------------------

Pressure Rating (see notes)										
Temperature (°C)	-20	0	38	100	150	200				
Max Pressure (barg)	102.1	102.1	102.1	93.2	90.2	87.6				

Pipes and Fittings (see notes)

Items	Code	Size	Wall	Class	Ends	Standard	Material					
Pipes	T-203	1/2" - 1 1/2"	S-40S	-	PE	ASME B36.10/B36.19	ASTM B444 Gr 1 (UNS N06625) SML					
		2" - 3"			BE			ASME B36.10	API 5L Gr X65 PSL 2 (SML or WLD SAW)			
	4" - 10"	STD										
	12" - 14"	XS										
	T-107	16"	0.562"		API 5L Gr X65 PSL 2 WLD SAW							
18"		0.625"										
		20"	0.688"									
Fittings	90 Elbow	C 01-33	1/2" - 1 1/2"	-	3000	SW	ASME B16.11					
	45 Elbow	C 02-33										
	Tee	C 03-33										
	Cross	C 05-33										
	Coupling	C 06-33										
	Cap	C 11-33										
	Sockolet	C 55-33										
	Red Tee	C 04-33										
	Red Coupling	C 08-33										
	90 LR Elbow	C 15-33										
	45 LR Elbow	C 16-33	2" - 3"	According to pipe	-	BE	ASME B16.9					
	90 SR Elbow	C 17-33										
	Tee	C 20-33										
	Cap	C 22-33										
	Cross	C 24-33										
	Weldolet	C 12-33						2" - 4"				
		C 12-22						2" - 8"				
	Conc. Red	C 18-33						3" - 4"	-	-	-	ASME B16.9
	Ecc. Red	C 19-33										
	Red Tee	C 21-33										
	Cross	C 24-22	4" - 16"									
	90 LR Elbow	C 15-22	4" - 20"	According to pipe	-	BE	MSS SP-75					
	45 LR Elbow	C 16-22										
	90 SR Elbow	C 17-22										
	Tee	C 20-22										
Cap	C 22-22											
Conc. Red	C 18-22	6" - 20"						-	-	-	ASME B16.9	
Ecc. Red	C 19-22											
Red Tee	C 21-22											
Nipple	Straight Nipple	N-S139						1/2" - 1 1/2"	According to pipe	-	PBE	ASTM A733
	Swage Conc Nipple	N-C133						3/4" - 1 1/2"				
		N-C433	2" - 3"									
	Swage Ecc Nipple	N-E133	3/4" - 1 1/2"									
		N-E433	2" - 3"									
Flanges	Socket Weld (SW)	F-600-JL	1/2" - 1 1/2"	According to pipe	Class 600	Raised Face	ASME B16.5					
	Welding Neck (WN)	F-600-KL	2" - 3"									
		F-600-KC	4" - 20"									
	Blind	F-600-LL	1/2" - 3"									
		F-600-LC	4" - 20"									
Bolts & Gasket Nuts	Spiral-Wound	J-600-EM	1/2" - 20"	-	Class 600	Raised Face	ASME B16.20					
	Stud and Nuts	P-600-07	1/2" - 1 1/2"	-	-	-	ASME B1.1					

		OFFSHORE PRODUCTION FACILITIES		Doc: I-ET-3010.1M-1200-200-P4X-001	Revision: F	Sheet: 2 of 2
		PIPING SPECIFICATION FOR TOPSIDE				Material: CS Inconel Clad.

Valves (see notes)

Type	Size	CODE	Temp	Type	Size	CODE	Temp	Type	Size	CODE	Temp	Type	Size	CODE	Temp
Needle	1/2" - 1 1/2"	VAG-3000-1-N102	-100C to 400C	Ball	2" - 4"	VES-600-1-C570	0C to 210C	Ball	2" - 20"	VES-600-2-C572	0C to 210C	Ball	6" - 20"	VES-600-4-C564	0C to 210C
Ball	1/2" - 1 1/2"	VES-801-1-N104	-46C to 150C			VES-600-1-C580	0C to 400C			VES-600-2-C580	0C to 400C			VES-600-4-C574	0C to 400C
		VES-801-1-N105	-100C to 200C			VES-600-2-C510	-29C to 150C			VES-600-2-C582	0C to 400C			VES-600-4-C584	0C to 400C
		VES-801-2-N101	-30C to 150C			VES-600-2-C524	0C to 150C			VES-600-3-C553	-29C to 150C			VDE-600-2-N101	-30C to 150C
		VES-801-2-N104	-46C to 150C			VES-600-2-C528	0C to 150C			VES-600-3-C562	0C to 210C			VDE-600-2-N107	-100C to 400C
		VES-801-2-N105	-100C to 200C			VES-600-2-C534	0C to 150C			VES-600-3-C563	0C to 210C			VDE-600-2-N108	-100C to 400C
		VES-801-3-N105	-100C to 200C		VES-600-2-C538	0C to 150C	VES-600-3-C572	0C to 210C	VDE-600-2-C515	-29C to 150C					
Ball	2" - 4"	VES-600-1-C524	0C to 150C		VES-600-2-C560	0C to 210C	VES-600-3-C573	0C to 210C	VGL-600-2-C501	-29C to 400C					
		VES-600-1-C534	0C to 150C		VES-600-2-C562	0C to 210C	VES-600-3-C582	0C to 400C	VRE-600-2-C515	-29C to 400C					
		VES-600-1-C560	0C to 210C		VES-600-2-C570	0C to 210C	VES-600-3-C583	0C to 400C							



Branch (see notes)

RUN SIZE	0.5	TEE																		
	0.75	RTEE	TEE																	
	1	RTEE	RTEE	TEE																
	1.5	RTEE	RTEE	RTEE	TEE															
	2	SOC	SOC	SOC	SOC	TEE														
	3	SOC	SOC	SOC	SOC	RTEE	TEE													
	4	SOC	SOC	SOC	SOC	RTEE	RTEE	TEE												
	6	SOC	SOC	SOC	SOC	WOL	RTEE	RTEE	TEE											
	8	SOC	SOC	SOC	SOC	WOL	WOL	RTEE	RTEE	TEE										
	10	SOC	SOC	SOC	SOC	WOL	WOL	WOL	RTEE	RTEE	TEE									
	12	SOC	SOC	SOC	SOC	WOL	WOL	WOL	RTEE	RTEE	RTEE	TEE								
14	SOC	SOC	SOC	SOC	WOL	WOL	WOL	RTEE	RTEE	RTEE	TEE									
16	SOC	SOC	SOC	SOC	WOL	WOL	WOL	RTEE	RTEE	RTEE	RTEE	TEE								
18	SOC	SOC	SOC	SOC	WOL	WOL	WOL	RTEE	RTEE	RTEE	RTEE	TEE								
20	SOC	SOC	SOC	SOC	WOL	WOL	WOL	RTEE	RTEE	RTEE	RTEE	RTEE	TEE							
	0.5	0.75	1	1.5	2	3	4	6	8	10	12	14	16	18	20					

WOL - Weldolet
 TEE - Tee
 RTEE - Red Tee
 HC - Half Coupling
 SOC - Sockolet

Notes

1	On the spec valve list, it may have valves codes which contain values of process data lower than spec limits. It shall be verified all valve process data (e.g.: pressure, temperature) in order to specify it according the design premisses.
2	See Annex A for valves requirements and general selection criteria.
4	See Annex C for instruments, drains and vents typical piping arrangement.
6	See Annex E for Isolation gasket specifications.
7	Welding and Welding Inspection activities shall follow the requeriments of these documents: I-ET-3010.00-1200-955-P4X-001-Welding and I-ET-3010.00-1200-955-P4X-002-Requirements for Welding Inspection
8	All valves, pipes and components specified for hydrogen sulfide service shall be in accordance with ISO 15156 requirements.
9	Charpy impact test is required at the minimum temperature of this spec, according to ASME B31.3 and API 5L requirements. Applicable to both base material and WPS qualification.
25	Charpy impact test is required at the minimum temperature of this spec, according to ASME B31.3 and standard material specification.
27	See Annex D to check the piping spec range application for H2S and CO2 service.
42	Piping, fittings and accessories shall have internal Inconel® 625 cladding according to I-ET-3010.00-1200-955-P4X-001 - Welding.
120	Wafer valves are not to be used with flammable or combustible services, according to NFPA definition.
125	Materials shall follow the requirements of IOGP S-563- Material Data Sheets for Piping and Valve Components. Coating for bolts and nuts shall follow spec note number 3.



		OFFSHORE PRODUCTION FACILITIES						Doc: I-ET-3010.1M-1200-200- P4X-001	Revision: F	Sheet 1 of 2
		PIPING SPECIFICATION FOR TOPSIDE						Issued by: SRGE/ESUP	Code: ASME B31.3	Corr. Allow. : -

Services (see notes): PC - Process (Corrosive Hydrocarbon);	Material: 3.5Ni InconelClad	Class: 600	Standard: E32
--	-----------------------------------	---------------	------------------

Pressure Rating (see notes)											
Temperature (°C)	-55	0	38	50	100	150	200	250	300	330	
Max Pressure (barg)	102.1	102.1	102.1	100.2	93.2	90.2	87.6	83.9	79.6	76.9	

Pipes and Fittings (see notes)

Items	Code	Size	Wall	Class	Ends	Standard	Material	
Pipes	T-203	1/2" - 1 1/2"	S-40S	-	PE	ASME B36.10/B36.19	ASTM B444 Gr 1 (UNS N06625) SML	
		2" - 3"	S-10S		BE			
		4" - 6"	STD					ASME B36.10
	8"	0.344"						
	10"	0.438"						
	12"	XS						
	T-211	14"	0.562"		ASTM A333 Gr 3 SML			
16"		0.625"	ASTM A333 Gr 3 WLD					
Fittings	90 Elbow	1/2" - 1 1/2"	-	3000	SW	ASME B16.11	ASTM B366 (UNS N06625)	
	45 Elbow							
	Tee							
	Cross							
	Coupling							
	Cap							
	Sockolet							
	Red Tee	3/4" - 1 1/2"	-	-	BE	ASME B16.11		
	Red Coupling							
	90 LR Elbow	2" - 3"	According to pipe	-	-	ASME B16.9		
	45 LR Elbow							
	90 SR Elbow							
	Tee							
	Cap							
	Cross							
	Weldolet							
	Conc. Red	3" - 4"	-	-	-	MSS SP-97		
	Ecc. Red							
	Red Tee							
	90 LR Elbow	4" - 16"	According to pipe	-	-	ASME B16.9		
	45 LR Elbow							
	90 SR Elbow							
	Tee							
	Cap							
Cross								
Conc. Red	6" - 16"						-	-
Ecc. Red								
Red Tee								
Nipple	Straight Nipple	N-S139	1/2" - 1 1/2"	According to pipe	-	PBE	ASTM A733	ASTM B444 Gr 1 (UNS N06625)
	Swage Conc Nipple	N-C133	3/4" - 1 1/2"			BLE x PSE	MSS SP-95	ASTM B366 (UNS N06625)
		N-C433	2" - 4"					
	Swage Ecc Nipple	N-E133	3/4" - 1 1/2"			2" - 4"	PBE	
N-E433		2" - 4"	BLE x PSE					
Flanges	Socket Weld (SW)	F-600-JL	1/2" - 1 1/2"	According to pipe	Class 600	Raised Face	ASME B16.5	ASTM B564 (UNS N06625)
	Welding Neck (WN)	F-600-KL	2" - 3"					ASTM A350 Gr LF3 Cladded
		F-600-KE	4" - 16"					
	Blind	F-600-LL	1/2" - 3"					ASTM B564 (UNS N06625)
		F-600-LE	4" - 16"					
Gasket	Spiral-Wound	J-600-EM	1/2" - 16"	-	Class 600	Raised Face	ASME B16.20	Inconel/graphite
Bolts & Nuts	Stud and Nuts	P-600-02	1/2" - 1 1/8"	-	-	-	ASME B1.1	A320 L7
								A194 7L

		OFFSHORE PRODUCTION FACILITIES		Doc: I-ET-3010.1M-1200-200-P4X-001	Revision: F	Sheet: 2 of 2
		PIPING SPECIFICATION FOR TOPSIDE				Material: 3.5Ni InconelClad

Valves (see notes)

Type	Size	CODE	Temp	Type	Size	CODE	Temp	Type	Size	CODE	Temp	Type	Size	CODE	Temp		
Needle	1/2" - 1 1/2"	VAG-3000-1-N102	-100C to 400C	Ball	2" - 4"	VES-600-1-A534	-46C to 150C	Ball	2" - 16"	VES-600-3-A582	-100C to 400C	Double Ball	1/2" - 2"	VDE-600-2-N108	-100C to 400C		
Butterfly	6" - 16"	VBO-600-3-A523	-100C to 345C			VES-600-2-A534				VES-600-3-A583							
Ball	1/2" - 1 1/2"	VES-801-1-N104	-46C to 150C			VES-600-2-A538				VES-600-4-A574				-100C to 200C		VDE-600-2-A515	-30C to 150C
		VES-801-1-N105	-100C to 200C			VES-600-2-A570				VES-600-4-A584				-100C to 400C		VDE-600-2-A571	-46C to 200C
		VES-801-2-N101	-30C to 150C			VES-600-2-A572				VES-600-2-A589				-100C to 340C		VDE-600-2-A581	-100C to 340C
		VES-801-2-N104	-46C to 150C			VES-600-2-A580				VES-600-3-A589				-100C to 400C		VGL-600-2-A501	-100C to 345C
		VES-801-2-N105	-100C to 200C			VES-600-2-A582				VDE-600-2-N105				-100C to 200C		VRE-800-1-N102	
		VES-801-2-N106	-100C to 340C			VES-600-3-A572				VDE-600-2-N106				-100C to 400C		VRE-600-2-A515	-100C to 400C
		VES-801-3-N105	-100C to 200C			VES-600-3-A573				VDE-600-2-N107				-100C to 400C		VRE-600-2-A535	



Branch (see notes)

RUN SIZE	0.5	TEE																			
	0.75	RTEE	TEE																		
	1	RTEE	RTEE	TEE																	
	1.5	RTEE	RTEE	RTEE	TEE																
	2	SOC	SOC	SOC	SOC	TEE															
	3	SOC	SOC	SOC	SOC	RTEE	TEE														
	4	SOC	SOC	SOC	SOC	RTEE	RTEE	TEE													
	6	SOC	SOC	SOC	SOC	WOL	RTEE	RTEE	TEE												
	8	SOC	SOC	SOC	SOC	WOL	WOL	RTEE	RTEE	TEE											
	10	SOC	SOC	SOC	SOC	WOL	WOL	WOL	RTEE	RTEE	TEE										
	12	SOC	SOC	SOC	SOC	WOL	WOL	WOL	RTEE	RTEE	RTEE	TEE									
	14	SOC	SOC	SOC	SOC	WOL	WOL	WOL	RTEE	RTEE	RTEE	TEE									
	16	SOC	SOC	SOC	SOC	WOL	WOL	WOL	RTEE	RTEE	RTEE	TEE									
		0.5	0.75	1	1.5	2	3	4	6	8	10	12	14	16							

WOL - Weldolet
 TEE - Tee
 RTEE - Red Tee
 HC - Half Coupling
 SOC - Sockolet

Notes

1	On the spec valve list, it may have valves codes which contain values of process data lower than spec limits. It shall be verified all valve process data (e.g.: pressure, temperature) in order to specify it according the design premisses.
2	See Annex A for valves requirements and general selection criteria.
4	See Annex C for instruments, drains and vents typical piping arrangement.
6	See Annex E for Isolation gasket specifications.
7	Welding and Welding Inspection activities shall follow the requeriments of these documents: I-ET-3010.00-1200-955-P4X-001-Welding and I-ET-3010.00-1200-955-P4X-002-Requirements for Welding Inspection
8	All valves, pipes and components specified for hydrogen sulfide service shall be in accordance with ISO 15156 requirements.
27	See Annex D to check the piping spec range application for H2S and CO2 service.
42	Piping, fittings and accessories shall have internal Inconel® 625 cladding according to I-ET-3010.00-1200-955-P4X-001 - Welding.
120	Wafer valves are not to be used with flammable or combustible services, according to NFPA definition.
125	Materials shall follow the requirements of IOGP S-563- Material Data Sheets for Piping and Valve Components. Coating for bolts and nuts shall follow spec note number 3.



		OFFSHORE PRODUCTION FACILITIES				Doc: I-ET-3010.1M-1200-200- P4X-001	Revision: F	Sheet 1 of 2
		PIPING SPECIFICATION FOR TOPSIDE					Issued by: SRGE/ESUP	Code: ASME B31.3

Services (see notes): CNI - Corrosive Chemical Injection (Except Sodium Hypochlorite); FG - Fuel Gas; G - Glycol; H - Hydraulic Fluid; P - Process (non-corrosive hydrocarbon); PC - Process (Corrosive Hydrocarbon);	Material: SS 316/316L	Class: 900	Standard: F3
--	-----------------------------	---------------	-----------------

Pressure Rating (see notes)										
Temperature (°C)	-100	38	50	100	150	200				
Max Pressure (barg)	148.9	148.9	144.3	126.6	115.5	107.0				

Pipes and Fittings (see notes)

Items	Code	Size	Wall	Class	Ends	Standard	Material	
Pipes	T-322	1/2" - 1 1/2"	S-40S	-	PE	ASME B36.19	ASTM A312 TP 316/316L SML	
		2" - 3"						
		4" - 8"						
	T-323	10"	0.594"		BE	ASME B36.10/B36.19	ASTM A358 Type 316/316L Cl 1 or 3 WLD	
		12"	0.688"					
		14"	0.750"					
		16"	0.844"					
		18"	1.000"					
Fittings	90 Elbow	1/2" - 1 1/2"	-	3000	SW	ASME B16.11	ASTM A182 Gr F316/316L	
	45 Elbow							
	Tee							
	Cross							
	Coupling							
	Cap							
	Socketlet	3/4" - 1 1/2"	-	-	-	MSS SP-97	-	
	Red Tee							
	Red Coupling	2" - 18"	According to pipe	-	BE	ASME B16.9	ASTM A403 Gr WP316/316L	
	Weldolet							
	90 LR Elbow							
	45 LR Elbow							
	90 SR Elbow							
	Tee							
	Cap							
	Cross							
Conc. Red								
Ecc. Red								
Red Tee	3" - 18"	-	-	-	-	-		
Red Tee								
Nipple	Straight Nipple	1/2" - 1 1/2"	According to pipe	-	PBE	ASTM A733	ASTM A312 TP316/316L	
	Swage Conc Nipple	3/4" - 1 1/2"						
	Swage Ecc Nipple	N-C144						2" - 4"
		N-E144						3/4" - 1 1/2"
Flanges	Socket Weld (SW)	F-1500-QX	1/2" - 1 1/2"	According to pipe	Class 1500	Ring Type Joint	ASTM A182 Gr F316/316L	
	Welding Neck (WN)	F-1500-RX	2"					
		F-900-RX	3" - 18"					
	Blind	F-1500-SX	1/2" - 2"					max 350 bar
		F-350-4X	1/2" - 3"					
		F-900-SX	3" - 18"					
	Hyd One-Piece Flange	F-350-3X	1/2" - 3"					max 350 bar
Bolt & Gasket	Ring-Joint	J-1500-AT	1/2" - 2"	-	Class 1500	Ring Type Joint	Stainless Steel AISI 316	
		J-900-AT	3" - 18"					
Bolts & Nuts	Stud and Nuts	P-900-08	3/4" - 1 1/8"	-	-	-	ASME B1.1	
							A320 L7, Zn-Ni	
							A194 7L, Zn-Ni	

		OFFSHORE PRODUCTION FACILITIES		Doc: I-ET-3010.1M-1200-200-P4X-001	Revision: F	Sheet: 2 of 2
		PIPING SPECIFICATION FOR TOPSIDE				Material: SS 316/316L

Valves (see notes)

Type	Size	CODE	Temp	Type	Size	CODE	Temp	Type	Size	CODE	Temp	Type	Size	CODE	Temp					
Needle	1/2" - 1 1/2"	VAG-3000-1-S201	-100C to 200C	Ball	2" - 18"	VES-900-2-S218	-30C to 150C	Ball	2" - 18"	VES-900-3-S239	-46C to 150C	Double Ball	3" - 8"	VDE-900-2-S214	-30C to 150C					
		VAG-3000-1-S202	-100C to 400C			VES-900-2-S224	0C to 150C			VES-900-3-S252	-30C to 150C			VDE-900-2-S215						
Butterfly	6" - 18"	VBO-900-3-S223	-100C to 345C			VES-900-2-S228				VES-900-3-S253				VDE-900-2-S234		-46C to 150C				
		VES-1502-1-S206	-30C to 150C			VES-900-2-S234	-46C to 150C			VES-900-3-S262	0C to 210C			VDE-900-2-S235						
		VES-1502-1-S207	-46C to 200C			VES-900-2-S238	-46C to 150C			VES-900-3-S263	0C to 210C			VDE-900-2-S270		-100C to 200C				
Ball	1/2" - 1 1/2"	VES-1502-2-S206	-30C to 150C			VES-900-2-S250	-30C to 150C			VES-900-3-S272	-46C to 200C	Gate	1/2" - 1 1/2"	VGA-1501-1-S201	-46C to 400C	Globe	2" - 4"	VGL-900-1-S201	-29C to 400C	
		VES-1502-2-S207	-100C to 200C			VES-900-2-S252	-100C to 200C			VES-900-3-S273	-100C to 200C			VGA-900-1-S231	-46C to 400C			VGL-900-2-S201	-100C to 400C	
		VES-1502-3-S207	-46C to 200C			VES-900-2-S260	0C to 210C			VES-900-4-S254	-30C to 150C			VES-900-4-S264	0C to 210C	VMA-900-2-S201	-30C to 93C			
		2" - 18"	VES-900-1-S214			-30C to 150C	VES-900-2-S262			0C to 210C	VES-900-4-S274	-46C to 200C	Double Ball	1/2" - 2"	VDE-900-2-S201	-30C to 150C	Check	1/2" - 1 1/2"	VRE-1500-1-S202	-100C to 400C
			VES-900-1-S222			0C to 120C	VES-900-2-S270			-100C to 200C	VDE-900-2-S202	-30C to 150C			VRE-1500-2-S202	-100C to 400C				
			VES-900-1-S224			0C to 150C	VES-900-2-S272	-100C to 200C	VDE-900-2-S203	-46C to 150C	VRE-900-1-S211	0C to 150C								
	VES-900-1-S234		-46C to 150C			VES-900-3-S218	-30C to 150C	VDE-900-2-S204	-46C to 150C	VRE-900-2-S212	-100C to 150C									
	VES-900-1-S250		-30C to 150C			VES-900-3-S219	-30C to 150C	VDE-900-2-S205	-100C to 200C	VRE-900-2-S215	-100C to 150C									
	VES-900-1-S260		0C to 210C			VES-900-3-S228	-46C to 150C													
	VES-900-1-S270		-46C to 200C																	
	VES-900-2-S214		-30C to 150C																	



Branch (see notes)

RUN SIZE	0.5	TEE																		
	0.75	RTEE	TEE																	
	1	RTEE	RTEE	TEE																
	1.5	RTEE	RTEE	RTEE	TEE															
	2	SOC	SOC	SOC	SOC	TEE														
	3	SOC	SOC	SOC	SOC	RTEE	TEE													
	4	SOC	SOC	SOC	SOC	RTEE	RTEE	TEE												
	6	SOC	SOC	SOC	SOC	WOL	RTEE	RTEE	TEE											
	8	SOC	SOC	SOC	SOC	WOL	WOL	RTEE	RTEE	TEE										
	10	SOC	SOC	SOC	SOC	WOL	WOL	WOL	RTEE	RTEE	TEE									
	12	SOC	SOC	SOC	SOC	WOL	WOL	WOL	RTEE	RTEE	RTEE	TEE								
	14	SOC	SOC	SOC	SOC	WOL	WOL	WOL	RTEE	RTEE	RTEE	TEE								
	16	SOC	SOC	SOC	SOC	WOL	WOL	WOL	RTEE	RTEE	RTEE	RTEE	TEE							
	18	SOC	SOC	SOC	SOC	WOL	WOL	WOL	WOL	RTEE	RTEE	RTEE	RTEE	TEE						
		0.5	0.75	1	1.5	2	3	4	6	8	10	12	14	16	18	BRANCH SIZE				

WOL - Weldolet
TEE - Tee
RTEE - Red Tee
HC - Half Coupling
SOC - Sockolet

Notes

1	On the spec valve list, it may have valves codes which contain values of process data lower than spec limits. It shall be verified all valve process data (e.g.: pressure, temperature) in order to specify it according the design premisses.
2	See Annex A for valves requirements and general selection criteria.
3	Bolts,nuts and gaskets (only RTJ gaskets) must be Zn-Ni coated according to Annex B.
4	See Annex C for instruments, drains and vents typical piping arrangement.
5	Flanges ≤ 1 1/2" may be used, if strictly necessary.
6	See Annex E for Isolation gasket specifications.
7	Welding and Welding Inspection activities shall follow the requeriments of these documents: I-ET-3010.00-1200-955-P4X-001-Welding and I-ET-3010.00-1200-955-P4X-002-Requirements for Welding Inspection
8	All valves, pipes and components specified for hydrogen sulfide service shall be in accordance with ISO 15156 requirements.
27	See Annex D to check the piping spec range application for H2S and CO2 service.
51	Stainless Steel external coating shall be applied for the temperature limits acc. to I-ET-3010.00-1200-956-P4X-002 - General Painting.
59	In case of use this spec below -30 °C, the material shall be furnished with solution heat treatment.
120	Wafer valves are not to be used with flammable or combustible services, according to NFPA definition.
125	Materials shall follow the requirements of IOGP S-563- Material Data Sheets for Piping and Valve Components. Coating for bolts and nuts shall follow spec note number 3.
127	ISO 6162-1/2 flanges may be used only for H - Hydraulic Fluid.



		OFFSHORE PRODUCTION FACILITIES						Doc: I-ET-3010.1M-1200-200- P4X-001	Revision: F	Sheet 1 of 2
		PIPING SPECIFICATION FOR TOPSIDE						Issued by: SRGE/ESUP	Code: ASME B31.3	Corr. Allow. : 1.6 mm

Services (see notes): GL - Refrigerated Liquefied Petroleum Gases in Low Temperature; P - Process (non-corrosive hydrocarbon);	Material: Low Temp CS	Class: 900	Standard: F6
---	-----------------------------	---------------	-----------------

Pressure Rating (see notes)										
Temperature (°C)	-46	0	38	50	100	200	300	320		
Max Pressure (barg)	144.1	144.1	144.1	142.4	136.0	131.4	119.5	116.7		

Pipes and Fittings (see notes)

Items		Code	Size	Wall	Class	Ends	Standard	Material	
Pipes	Pipe	T-105	1/2" - 1 1/2"	S-160	-	PE	ASME B36.10	ASTM A333 Gr 6 SML	
			2" - 4"	XS					
			6"	0.500"					
			8" - 10"	S-100					
			12"	0.812"					
		T-106	14"	0.875"					
			16"	0.938"					
			18"	1.000"					
			20"	1.125"					
Fittings	90 Elbow	C01-04	1/2" - 1 1/2"	-	6000	SW	ASME B16.11	ASTM A350 Gr LF2 Cl 1	
	45 Elbow	C02-04							
	Tee	C03-04							
	Cross	C05-04							
	Coupling	C06-04							
	Cap	C11-04							
	Socket	C55-04	3/4" - 1 1/2"	-	-	-	MSS SP-97		
	Red Tee	C04-04					ASME B16.11		
	Red Coupling	C08-04					MSS SP-97		
	Weldolet	C12-04	2" - 20"	According to pipe	-	BE	ASME B16.9		ASTM A420 Gr WPL6
	90 LR Elbow	C15-05							
	45 LR Elbow	C16-05							
	90 SR Elbow	C17-05							
	Tee	C20-05							
	Cap	C22-05							
	Cross	C24-05	3" - 20"	-	-	-	-		-
	Conc. Red	C18-05							
	Ecc. Red	C19-05							
Red Tee	C21-05								
Nipple	Straight Nipple	N-S137	1/2" - 1 1/2"	According to pipe	-	PBE	ASTM A733	ASTM A333 Gr 6	
	Swage Conc Nipple	N-C105	3/4" - 1 1/2"						
	Swage Ecc Nipple	N-E105	2" - 4"						
		N-E405	3/4" - 1 1/2"						
Flanges	Socket Weld (SW)	F-1500-Q3	1/2" - 1 1/2"	According to pipe	-	Ring Type Joint	ASME B16.5	ASTM A350 Gr LF2 Class 1	
	Welding Neck (WN)	F-1500-R3	2"						Class 1500
		F-900-R3	3" - 20"						Class 900
	Blind	F-1500-S3	1/2" - 2"						Class 1500
		F-900-S3	3" - 20"						Class 900
	Gasket	Ring-Joint	J-1500-AT						1/2" - 2"
J-900-AT			3" - 20"	Class 900					
Bolts & Nuts	Stud and Nuts	P-900-07	3/4" - 2"	-	-	-	ASME B1.1	A193 B7, Zn-Ni	
								A194 Gr 2H, Zn-Ni	



		OFFSHORE PRODUCTION FACILITIES						Doc: I-ET-3010.1M-1200-200-P4X-001	Revision: F	Sheet 1 of 2
		PIPING SPECIFICATION FOR TOPSIDE						Issued by: SRGE/ESUP	Code: ASME B31.3	Corr. Allow. : 1.6 mm

Services (see notes): BG - Inert Gas; CI - Chemical Injection (non-corrosive); FG - Fuel Gas; G - Glycol; IW - De-Aerated Sea Water Injection; P - Process (non-corrosive hydrocarbon); W - Industrial water;	Material: Carbon Steel	Class: 900	Standard: F10
---	----------------------------------	----------------------	-------------------------

Pressure Rating (see notes)										
Temperature (°C)	-20	0	38	50	100	150	200			
Max Pressure (barg)	153.2	153.2	153.2	150.4	139.8	135.2	131.4			

Pipes and Fittings (see notes)

Items		Code	Size	Wall	Class	Ends	Standard	Material							
Pipes	Pipe	T-102	1/2" - 1 1/2"	S-160	-	PE	ASME B36.10	API 5L Gr B PSL 1 SML							
		T-107	2" - 8"	XS		BE		API 5L Gr X65 PSL 2 (SML or WLD SAW)							
			10"	0.625"											
			12" - 14"	S-80											
			16" - 20"												
24"	1.188"		API 5L Gr X65 PSL 2 WLD SAW												
Fittings	90 Elbow	C01-02	1/2" - 1 1/2"	-	6000	SW	ASME B16.11	ASTM A105							
	45 Elbow	C02-02													
	Tee	C03-02													
	Cross	C05-02													
	Coupling	C06-02													
	Cap	C11-02													
	Socket	C55-02													
	Red Tee	C04-02	3/4" - 1 1/2"	-	-	ASME B16.11	-								
	Red Coupling	C08-02													
	Weldolet	C12-22	2" - 10"	According to pipe	-	BE	MSS SP-97	ASTM A694 Gr F65							
	90 LR Elbow	C15-22													
	45 LR Elbow	C16-22													
	90 SR Elbow	C17-22													
	Tee	C20-22	2" - 24"						-	BE	MSS SP-75	ASTM A860 WPHY65			
	Cap	C22-22													
Cross	C24-22														
Conc. Red	C18-22	3" - 24"	-						-	-	-				
Ecc. Red	C19-22														
Red Tee	C21-22														
Nipple	Straight Nipple	N-S120	1/2" - 1 1/2"	According to pipe	-	PBE	ASTM A733	API 5L Gr B PSL 1 seamless							
	Swage Conc Nipple	N-C103	3/4" - 1 1/2"			BLE x PSE	MSS SP-95	-	-						
		N-C422	2" - 4"												
	Swage Ecc Nipple	N-E103	3/4" - 1 1/2"			2" - 4"	BLE x PSE	-	-	-					
		N-E422													
Flanges	Socket Weld (SW)	F-1500-Q2	1/2" - 1 1/2"	According to pipe	Class 1500	Ring Type Joint	ASME B16.5	ASTM A105							
	Welding Neck (WN)	F-1500-RC	2"					Class 900	-	-	ASTM A694 Gr F65				
		F-900-RC	3" - 24"												
	Blind	F-1500-S2	1/2" - 1 1/2"					Class 1500	-	-	-				
		F-1500-SC	2"									Class 900	-	-	ASTM A694 Gr F65
		F-900-SC	3" - 24"												
Bolts & Gasket Nuts	Ring-Joint	J-1500-AN	1/2" - 2"	-	Class 1500	Ring Type Joint	ASME B16.20	Carbon Steel							
		J-900-AN	3" - 24"					Class 900							
Bolts & Nuts	Stud and Nuts	P-900-07	3/4" - 2 1/2"	-	-	-	ASME B1.1	A193 B7, Zn-Ni							
								A194 Gr 2H, Zn-Ni							

		OFFSHORE PRODUCTION FACILITIES				Doc: I-ET-3010.1M-1200-200-P4X-001	Revision: F	Sheet 1 of 2
		PIPING SPECIFICATION FOR TOPSIDE					Issued by: SRGE/ESUP	Code: ASME B31.3

Services (see notes): CNI - Corrosive Chemical Injection (Except Sodium Hypochlorite); FG - Fuel Gas; G - Glycol; H - Hydraulic Fluid; IA - Instrumentation Air; P - Process (non-corrosive hydrocarbon); PC - Process (Corrosive Hydrocarbon);	Material: SS 316/316L	Class: 1500	Standard: G3
--	-----------------------------	----------------	-----------------

Pressure Rating (see notes)										
Temperature (°C)	-100	38	50	100	150	210				
Max Pressure (barg)	248.2	248.2	240.6	211	192.5	176.0				

Pipes and Fittings (see notes)

Items		Code	Size	Wall	Class	Ends	Standard	Material			
Pipes	Pipe	T-322	1/2" - 1 1/2"	S-80S	-	PE	ASME B36.19	ASTM A312 TP 316/316L SML			
		T-323	2"			BE	ASME B36.10/B36.19	ASTM A358 Type 316/316L Cl 1 or 3 WLD			
			3" - 4"	0.438"							
			6"	0.625"							
			8"	0.750"							
			10"	0.938"							
			12"	1.125"							
		14"	1.250"								
16"	1.438"										
Fittings	90 Elbow	C01-43	1/2" - 1 1/2"	-	3000	SW	ASME B16.11	ASTM A182 Gr F316/316L			
	45 Elbow	C02-43									
	Tee	C03-43									
	Cross	C05-43									
	Coupling	C06-43									
	Cap	C11-43									
	Socket	C55-43									
	Red Tee	C04-43	3/4" - 1 1/2"	-	-	ASME B16.11	-				
	Red Coupling	C08-43									
	Weldolet	C12-43	1"	According to pipe	-	-	BE	MSS SP-97	ASTM A403 Gr WP316/316L		
	90 LR Elbow	C15-44	2" - 16"								
		45 LR Elbow								C16-44	
		90 SR Elbow								C17-44	
		Tee								C20-44	
		Cap								C22-44	
		Cross								C24-44	
		Conc. Red								C18-44	3" - 16"
		Ecc. Red								C19-44	
Red Tee		C21-44									
Nipple	Straight Nipple	N-S145	1/2" - 1 1/2"	According to pipe	-	-	PBE	ASTM A733	ASTM A312 TP316/316L		
	Swage Conc Nipple	N-C144	3/4" - 1 1/2"				BLE x PSE	MSS SP-95	ASTM A403 Gr WP316/316L		
		N-C444	2" - 4"								
	Swage Ecc Nipple	N-E144	3/4" - 1 1/2"				2" - 4"	BLE x PSE	-	-	
N-E444		2" - 4"									
Flanges	Socket Weld (SW)	F-1500-QX	1/2" - 1 1/2"	According to pipe	Class 1500	Ring Type Joint	ASME B16.5	ASTM A182 Gr F316/316L			
	Welding Neck (WN)	F-1500-RX	2" - 16"								
	Blind	F-350-4X	1/2" - 3"						max 350 bar	-	ISO 6162-1
		F-1500-SX	1/2" - 16"						Class 1500	Ring Type Joint	ASME B16.5
Hyd One-Piece Flange	F-350-3X	1/2" - 3"	max 350 bar	-	ISO 6162-1						
Bolts & Gasket Nuts	Ring-Joint	J-1500-AT	1/2" - 16"	-	Class 1500	Ring Type Joint	ASME B16.20	Stainless Steel AISI 316			
	Stud and Nuts	P-1500-08	3/4" - 2 1/2"	-	-	-	ASME B1.1	A320 L7, Zn-Ni A194 7L, Zn-Ni			

Valves (see notes)



Type	Size	CODE	Temp	Type	Size	CODE	Temp	Type	Size	CODE	Temp	Type	Size	CODE	Temp
Needle	½" - 1 ½"	VAG-5000-1-S201	-100C to 200C	Ball	2" - 16"	VES-1500-2-S228	0C to 150C	Ball	2" - 16"	VES-1500-3-S252	-30C to 150C	Double Ball	3" - 8"	VDE-1500-2-S214	-30C to 150C
		VAG-5000-1-S202	-100C to 400C			VES-1500-2-S234	-46C to 150C			VES-1500-3-S253	-30C to 150C			VDE-1500-2-S215	-30C to 150C
VES-1502-1-S206	-30C to 150C	VES-1500-2-S238	-46C to 150C			VES-1500-3-S262	0C to 210C			VDE-1500-2-S234	-46C to 150C				
VES-1502-1-S207	-46C to 200C	VES-1500-2-S250	-30C to 150C			VES-1500-3-S263	-100C to 200C			VDE-1500-2-S235	-46C to 150C				
VES-1502-2-S206	-30C to 150C	VES-1500-2-S252	-30C to 150C			VES-1500-3-S272	-100C to 200C			VDE-1500-2-S270	-100C to 200C				
VES-1502-2-S207	-100C to 200C	VES-1500-2-S260	0C to 210C			VES-1500-4-S254	-30C to 150C			Gate	2" - 16"			VGA-1501-1-S201	-46C to 400C
VES-1502-3-S207	-46C to 200C	VES-1500-2-S262	0C to 210C			VES-1500-4-S264	0C to 210C	VGA-1500-1-S231	-29C to 400C						
Ball	2" - 16"	VES-1500-1-S214	-30C to 150C			VES-1500-2-S270	-100C to 200C	VES-1500-4-S274	-100C to 200C	Check	½" - 1 ½"	VRE-1500-1-S202	-100C to 400C		
		VES-1500-1-S218	-46C to 150C			VES-1500-3-S218	-30C to 150C	VDE-1500-2-S201	-30C to 150C			VRE-1500-2-S202	-100C to 400C		
		VES-1500-1-S250	-30C to 150C			VES-1500-3-S219	-30C to 150C	VDE-1500-2-S202	-30C to 150C			VRE-1500-2-S212	-100C to 400C		
		VES-1500-1-S260	0C to 210C			VES-1500-3-S228	0C to 150C	VDE-1500-2-S203	-46C to 150C			VRE-1500-2-S215	-100C to 210C		
		VES-1500-1-S270	-100C to 200C			VES-1500-3-S229	0C to 150C	VDE-1500-2-S204	-46C to 150C	Globe	2" - 14"	VRE-1500-2-S235	-100C to 210C		
		VES-1500-2-S214	-30C to 150C	VES-1500-3-S238	-46C to 150C	VDE-1500-2-S205	-100C to 200C	VGL-1500-2-S201	-46C to 400C						
		VES-1500-2-S218	-30C to 150C	VES-1500-3-S239	-46C to 150C	VDE-1500-2-S206	-100C to 200C	VGL-1500-2-S202	-100C to 400C						
		VES-1500-2-S224	0C to 150C												

Branch (see notes)

RUN SIZE	0.5	0.75	1	1.5	2	3	4	6	8	10	12	14	16	
	TEE	RTEE	RTEE	RTEE	RTEE	RTEE	RTEE	RTEE	RTEE	RTEE	RTEE	RTEE	RTEE	WOL - Weldolet
														TEE - Tee
														RTEE - Red Tee
														HC - Half Coupling
														SOC - Sockolet

Notes

1	On the spec valve list, it may have valves codes which contain values of process data lower than spec limits. It shall be verified all valve process data (e.g.: pressure, temperature) in order to specify it according the design premisses.
2	See Annex A for valves requirements and general selection criteria.
3	Bolts,nuts and gaskets (only RTJ gaskets) must be Zn-Ni coated according to Annex B.
4	See Annex C for instruments, drains and vents typical piping arrangement.
5	Flanges ≤ 1 1/2" may be used, if strictly necessary.
6	See Annex E for Isolation gasket specifications.
7	Welding and Welding Inspection activities shall follow the requeriments of these documents: I-ET-3010.00-1200-955-P4X-001-Welding and I-ET-3010.00-1200-955-P4X-002-Requirements for Welding Inspection
8	All valves, pipes and components specified for hydrogen sulfide service shall be in accordance with ISO 15156 requirements.
51	Stainless Steel external coating shall be applied for the temperature limits acc. to I-ET-3010.00-1200-956-P4X-002 - General Painting.
59	In case of use this spec below -30 °C, the material shall be furnished with solution heat treatment.
120	Wafer valves are not to be used with flammable or combustible services, according to NFPA definition.
125	Materials shall follow the requirements of IOGP S-563- Material Data Sheets for Piping and Valve Components. Coating for bolts and nuts shall follow spec note number 3.
127	ISO 6162-1/2 flanges may be used only for H - Hydraulic Fluid.

		OFFSHORE PRODUCTION FACILITIES				Doc: I-ET-3010.1M-1200-200- P4X-001	Revision: F	Sheet 1 of 2
		PIPING SPECIFICATION FOR TOPSIDE					Issued by: SRGE/ESUP	Code: ASME B31.3



Services (see notes): CNI - Corrosive Chemical Injection (Except Sodium Hypochlorite); H - Hydraulic Fluid; P - Process (non-corrosive hydrocarbon); PC - Process (Corrosive Hydrocarbon);	Material: SS 316/316L	Class: 2500	Standard: H3
---	-----------------------------	----------------	-----------------

Pressure Rating (see notes)

Temperature (°C)	-100	100	150							
Max Pressure (barg)	351	351	320.8							

Pipes and Fittings (see notes)

Items	Code	Size	Wall	Class	Ends	Standard	Material	
Pipes	T-322	1"	S-80S	-	PE	ASME B36.19	ASTM A312 TP 316/316L SML	
		1 1/2"	0.281"					
	T-323	2"	0.344"		-	BE	ASME B36.10/B36.19	ASTM A358 Type 316/316L Cl 1 or 3 WLD
		3"	0.438"					
		4"	0.531"					
		6"	0.864"					
		8"	1.250"					
		10" - 12"	1.500"					
14"	1.750"							
16"	2.000"							
Fittings	Weldolet	C 12-43	1" - 6"	According to pipe	-	ASME B16.9	ASTM A403 Gr WP316/316L	
	90 LR Elbow	C 15-44	1" - 16"					
	45 LR Elbow	C 16-44						
	90 SR Elbow	C 17-44						
	Cap	C 22-44						
	Cross	C 24-44						
	Red Tee	C 21-44						1 1/2" - 16"
	Conc. Red	C 18-44						2" - 16"
	Ecc. Red	C 19-44						
	Tee	C 20-44						
Flanges	Welding Neck (WN)	F-2500-RX	1" - 12"	According to pipe	Class 2500	-	ASTM A182 Gr F316/316L	
	Blind	F-420-4X	1" - 3"					
		F-2500-SX	1" - 12"					
	Compact WN	F-2500-UX	4" - 16"					
	Compact Blind	F-2500-VX	4" - 16"					
Hyd One-Piece Flange	F-420-3X	1" - 3"						
Bolts & Gasket	Ring-Joint	J-2500-AT	1" - 12"	-	Class 2500	Ring Type Joint	ASME B16.20	
		J-2500-BT	4" - 16"			Metallic Seal Joint	ISO 27509	
Bolts & Nuts	Stud and Nuts	P-2500-11	7/8" - 2 3/4"	-	-	-	ASME B1.1	
							A320 L7M, Zn-Ni	
							A194 7L, Zn-Ni	

		OFFSHORE PRODUCTION FACILITIES	Doc: I-ET-3010.1M-1200-200-P4X-001	Revision: F	Sheet: 2 of 2
		PIPING SPECIFICATION FOR TOPSIDE		Material: SS 316/316L	Class: 2500

Valves (see notes)

Type	Size	CODE	Temp	Type	Size	CODE	Temp	Type	Size	CODE	Temp	Type	Size	CODE	Temp
Needle	1" - 1 1/2"	VAG-6000-1-S201	-100C to 200C	Ball	2" - 3"	VES-2500-2-S252	-30C to 150C	Ball	4" - 16"	VES-2510-2-S228	0C to 120C	Double Ball	1" - 2"	VDE-2500-2-S204	-46C to 150C
		VAG-6000-1-S202	-100C to 400C			VES-2500-2-S260	0C to 210C			VES-2510-2-S234	-46C to 120C			VDE-2500-2-S205	-100C to 150C
VES-2502-2-S208	-30C to 120C	VES-2500-2-S262	-100C to 200C			VES-2510-2-S238	-30C to 150C			VDE-2500-2-S235	-46C to 150C				
VES-2502-2-S209	-100C to 200C	VES-2500-2-S270	-100C to 200C			VES-2510-2-S250	-30C to 150C			VDE-2500-2-S270	-100C to 200C				
VES-2502-3-S209	-46C to 200C	VES-2500-2-S272	-30C to 150C			VES-2510-2-S252	0C to 210C			VDE-2510-2-S235	-46C to 120C				
VES-2503-2-S208	-30C to 120C	VES-2500-3-S252	-30C to 150C			VES-2510-2-S260	-100C to 200C			VRE-2500-2-S202	-100C to 400C				
VES-2503-2-S209	-46C to 200C	VES-2500-3-S253	0C to 210C			VES-2510-2-S262	-30C to 150C			VRE-2500-2-S212	-46C to 210C				
VES-2503-3-S209	-100C to 200C	VES-2500-3-S262	-100C to 200C			VES-2510-2-S270	0C to 210C			VRE-2500-2-S215	-100C to 210C				
VES-2500-2-S215	-30C to 150C	VES-2500-3-S263	0C to 210C			VES-2510-3-S252	-30C to 150C			VRE-2500-2-S235	-100C to 210C				
VES-2500-2-S218	-30C to 120C	VES-2500-3-S272	-100C to 200C			VES-2510-3-S253	-30C to 150C			VRE-2510-2-S212	-46C to 210C				
VES-2500-2-S219	-30C to 120C	VES-2510-2-S214	-30C to 120C			VES-2510-3-S262	0C to 210C			VRE-2510-2-S215	-100C to 210C				
VES-2500-2-S224	0C to 120C	VES-2510-2-S215	-30C to 120C			VES-2510-3-S263	0C to 210C			VRE-2510-2-S212	-46C to 210C				
VES-2500-2-S228	0C to 120C	VES-2510-2-S218	-30C to 120C			VES-2510-3-S272	-100C to 200C			VRE-2510-2-S235	-100C to 210C				
VES-2500-2-S234	-46C to 120C	VES-2510-2-S219	-30C to 120C			VES-2510-3-S273	-100C to 200C			VGL-2500-2-S201	-46C to 400C				
VES-2500-2-S238	-46C to 120C	VES-2510-2-S224	0C to 120C			VDE-2500-2-S203	-46C to 150C			VGL-2500-2-S202	-100C to 400C				
VES-2500-2-S250	-30C to 150C									VGL-2510-2-S201	-46C to 400C				



Branch (see notes)

RUN SIZE	1	TEE														
	1.5	RTEE	TEE													
	2	RTEE	RTEE	TEE												
	3	WOL	RTEE	RTEE	TEE											
	4	WOL	WOL	RTEE	RTEE	TEE										
	6	WOL	WOL	WOL	RTEE	RTEE	TEE									
	8	WOL	WOL	WOL	WOL	RTEE	RTEE	TEE								
	10	WOL	WOL	WOL	WOL	WOL	RTEE	RTEE	TEE							
	12	WOL	WOL	WOL	WOL	WOL	RTEE	RTEE	RTEE	TEE						
	14	WOL	WOL	WOL	WOL	WOL	WOL	RTEE	RTEE	RTEE	TEE					
	16	WOL	WOL	WOL	WOL	WOL	WOL	RTEE	RTEE	RTEE	RTEE	TEE				
		1	1.5	2	3	4	6	8	10	12	14	16				
		BRANCH SIZE														

- WOL - Weldolet
- TEE - Tee
- RTEE - Red Tee
- HC - Half Coupling
- SOC - Sockolet

Notes



1	On the spec valve list, it may have valves codes which contain values of process data lower than spec limits. It shall be verified all valve process data (e.g.: pressure, temperature) in order to specify it according the design premisses.
2	See Annex A for valves requirements and general selection criteria.
3	Bolts,nuts and gaskets (only RTJ gaskets) must be Zn-Ni coated according to Annex B.
4	See Annex C for instruments, drains and vents typical piping arrangement.
5	Flanges ≤ 1 1/2" may be used, if strictly necessary.
6	See Annex E for Isolation gasket specifications.
7	Welding and Welding Inspection activities shall follow the requeriments of these documents: I-ET-3010.00-1200-955-P4X-001-Welding and I-ET-3010.00-1200-955-P4X-002-Requirements for Welding Inspection
8	All valves, pipes and components specified for hydrogen sulfide service shall be in accordance with ISO 15156 requirements.
51	Stainless Steel external coating shall be applied for the temperature limits acc. to I-ET-3010.00-1200-956-P4X-002 - General Painting.
59	In case of use this spec below -30 °C, the material shall be furnished with solution heat treatment.
120	Wafer valves are not to be used with flammable or combustible services, according to NFPA definition.
125	Materials shall follow the requirements of IOGP S-563- Material Data Sheets for Piping and Valve Components. Coating for bolts and nuts shall follow spec note number 3.
127	ISO 6162-1/2 flanges may be used only for H - Hydraulic Fluid.
131	For PSV assembly shall be used ASME flanges until NPS 12.

		OFFSHORE PRODUCTION FACILITIES				Doc: I-ET-3010.1M-1200-200-P4X-001	Revision: F	Sheet 1 of 2
		PIPING SPECIFICATION FOR TOPSIDE					Issued by: SRGE/ESUP	Code: ASME B31.3

Services (see notes): G - Glycol; P - Process (non-corrosive hydrocarbon);	Material: Low Temp CS	Class: 2500	Standard: H6
---	--------------------------	----------------	-----------------

Pressure Rating (see notes)										
Temperature (°C)	-46	180								
Max Pressure (barg)	275	275								

Pipes and Fittings (see notes)										
Items	Code	Size	Wall	Class	Ends	Standard	Material			
Pipes	Pipe	T-105	1" - 1 1/2"	S-160	-	PE	ASME B36.10	ASTM A333 Gr 6 SML		
			2"							
			3" - 6"			XXS				
			8"			1.000"				
		T-106	10"	1.250"						
			12"	1.500"						
			14"	1.625"						
			16"	1.750"						
		18"	2.000"		BE		ASTM A333 Gr 6 WLD			
							ASTM A671 Gr CC60 Class 22 WLD			
Fittings	Weldolet	C 12-04	1" - 8"	According to pipe	-	BE	MSS SP-97	ASTM A350 Gr LF2 Cl 1		
	90 LR Elbow	C 15-05	1" - 18"			-	ASME B16.9	ASTM A420 Gr WPL6		
	45 LR Elbow	C 16-05								
	90 SR Elbow	C 17-05								
	Tee	C 20-05								
	Cap	C 22-05								
	Cross	C 24-05								
	Conc. Red	C 18-05								
	Ecc. Red	C 19-05	1 1/2" - 18"							
Red Tee	C 21-05									
Nipple	Straight Nipple	N-S237	1" - 1 1/2"	According to pipe	-	BBE	ASTM A733	ASTM A333 Gr 6		
	Swage Conc Nipple	N-C205	2" - 4"				MSS SP-95	ASTM A420 Gr WPL6		
	Swage Ecc Nipple	N-E205								
Flanges	Welding Neck (WN)	F-2500-R3	1" - 12"	According to pipe	Class 2500	Ring Type Joint	ASME B16.5	ASTM A350 Gr LF2 Class 1		
	Blind	F-2500-S3	4" - 18"			IX seal ring	ISO 27509			
	Compact WN	F-2500-U3								
	Compact Blind	F-2500-V3								
Gasket	Ring-Joint	J-2500-AT	1" - 12"	-	Class 2500	Ring Type Joint	ASME B16.20	Stainless Steel AISI 316		
		J-2500-BT	4" - 18"			Metallic Seal Joint	ISO 27509			
Bolts & Nuts	Stud and Nuts	P-2500-11	7/8" - 2 3/4"	-	-	-	ASME B1.1	A320 L7M, Zn-Ni		
								A194 7L, Zn-Ni		

		OFFSHORE PRODUCTION FACILITIES	Doc:	Revision:	Sheet:
			I-ET-3010.1M-1200-200-P4X-001	F	2 of 2
PIPING SPECIFICATION FOR TOPSIDE			Material:	Class:	Standard:
			Low Temp CS	2500	H6

Valves (see notes)

Type	Size	CODE	Temp	Type	Size	CODE	Temp	Type	Size	CODE	Temp	Type	Size	CODE	Temp	
Needle	1" - 1 1/2"	VAG-6000-1-S201	-100C to 200C	Ball	2" - 3"	VES-2500-2-C272	-46C to 200C	Ball	4" - 18"	VES-2510-2-C272	-46C to 200C	Double Ball	4" - 8"	VDE-2510-2-C235	-46C to 120C	
		VAG-6000-1-S202	-100C to 400C			VES-2500-3-C252	-30C to 150C			VES-2510-3-C252	-30C to 150C			VDE-2510-2-C271	-46C to 200C	
VES-2503-2-C208	-30C to 120C	VES-2500-3-C253	-30C to 150C			VES-2510-3-C253	-30C to 150C			Check	1" - 1 1/2"	VRE-2500-1-C202	-46C to 345C			
VES-2503-2-C209	-46C to 200C	VES-2500-3-C272	-46C to 200C			VES-2510-3-C272	-46C to 200C					VRE-2500-2-C213	-46C to 200C			
VES-2503-3-C209	-46C to 200C	VES-2500-3-C273	-46C to 200C			VES-2510-3-C273	-46C to 200C					VRE-2500-2-C215	-46C to 200C			
Ball	2" - 3"	VES-2500-2-C214	-30C to 120C		Ball	4" - 18"	VES-2510-2-C214	-30C to 120C	Double Ball	1" - 2"	VDE-2500-2-C203	-46C to 150C	Globe	2" - 3"	VGL-2500-2-C201	-46C to 345C
		VES-2500-2-C218	-30C to 120C				VES-2510-2-C218	-30C to 120C			VDE-2500-2-C204	-46C to 150C			VRE-2510-2-C213	-46C to 345C
		VES-2500-2-C234	-46C to 120C				VES-2510-2-C234	-46C to 120C			VDE-2500-2-C205	-46C to 200C			VRE-2510-2-C215	-46C to 200C
		VES-2500-2-C238	-46C to 120C				VES-2510-2-C238	-46C to 120C			VDE-2500-2-C215	-30C to 150C			VRE-2510-2-C235	-46C to 345C
		VES-2500-2-C250	-30C to 150C			VES-2510-2-C250	-30C to 150C	VDE-2500-2-C235		-46C to 150C	VGL-2510-2-C201	-46C to 345C				
		VES-2500-2-C252	-30C to 150C	VES-2510-2-C252		-30C to 150C	VDE-2500-2-C271	-46C to 200C								
		VES-2500-2-C270	-46C to 200C	VES-2510-2-C270		-46C to 200C	VDE-2510-2-C215	-30C to 120C								



Branch (see notes)

RUN SIZE	1	TEE	1.5	RTEE	TEE	2	RTEE	RTEE	TEE	3	WOL	RTEE	RTEE	TEE	4	WOL	WOL	RTEE	RTEE	TEE	6	WOL	WOL	WOL	RTEE	RTEE	TEE	8	WOL	WOL	WOL	WOL	RTEE	RTEE	TEE	10	WOL	WOL	WOL	WOL	WOL	RTEE	RTEE	TEE	12	WOL	WOL	WOL	WOL	WOL	RTEE	RTEE	RTEE	TEE	14	WOL	WOL	WOL	WOL	WOL	WOL	RTEE	RTEE	RTEE	TEE	16	WOL	WOL	WOL	WOL	WOL	WOL	WOL	RTEE	RTEE	RTEE	TEE	18	WOL	WOL	WOL	WOL	WOL	WOL	WOL	WOL	RTEE	RTEE	RTEE	TEE
	1	1.5	2	3	4	6	8	10	12	14	16	18																																																																														

WOL - Weldolet
 TEE - Tee
 RTEE - Red Tee
 HC - Half Coupling
 SOC - Sockolet

Notes

1	On the spec valve list, it may have valves codes which contain values of process data lower than spec limits. It shall be verified all valve process data (e.g.: pressure, temperature) in order to specify it according the design premisses.
2	See Annex A for valves requirements and general selection criteria.
3	Bolts,nuts and gaskets (only RTJ gaskets) must be Zn-Ni coated according to Annex B.
4	See Annex C for instruments, drains and vents typical piping arrangement.
5	Flanges ≤ 1 1/2" may be used, if strictly necessary .
6	See Annex E for Isolation gasket specifications.
7	Welding and Welding Inspection activities shall follow the requeriments of these documents: I-ET-3010.00-1200-955-P4X-001-Welding and I-ET-3010.00-1200-955-P4X-002-Requirements for Welding Inspection
8	All valves, pipes and components specified for hydrogen sulfide service shall be in accordance with ISO 15156 requirements.
25	Charpy impact test is required at the minimum temperature of this spec, according to ASME B31.3 and standard material specification.
120	Wafer valves are not to be used with flammable or combustible services, according to NFPA definition.
125	Materials shall follow the requirements of IOGP S-563- Material Data Sheets for Piping and Valve Components. Coating for bolts and nuts shall follow spec note number 3.
131	For PSV assembly shall be used ASME flanges until NPS 12.



		OFFSHORE PRODUCTION FACILITIES				Doc: I-ET-3010.1M-1200-200- P4X-001	Revision: F	Sheet 1 of 2
		PIPING SPECIFICATION FOR TOPSIDE					Issued by: SRGE/ESUP	Code: ASME B31.3

Services (see notes): D - Diesel; P - Process (non-corrosive hydrocarbon); W - Industrial water;	Material: Carbon Steel	Class: 2500	Standard: H10
---	----------------------------------	-----------------------	-------------------------

Pressure Rating (see notes)										
Temperature (°C)	-20	175								
Max Pressure (barg)	351	351								

Pipes and Fittings (see notes)

Items	Code	Size	Wall	Class	Ends	Standard	Material														
Pipes	T-102	1" - 1 1/2"	XXS	-	PE	ASME B36.10	API 5L Gr B PSL 1 SML														
	T-107	2" - 6"	1.000"		-		BE	ASME B36.10	API 5L Gr X65 PSL 2 (SML or WLD SAW)												
		8"	1.250"						-	BE	ASME B36.10	API 5L Gr X65 PSL 2 WLD SAW									
		10"	1.500"									-	BE	ASME B36.10	API 5L Gr X65 PSL 2 WLD SAW						
		12" - 14"	1.750"												-	BE	ASME B36.10	API 5L Gr X65 PSL 2 WLD SAW			
		16"	2.000"															-	BE	ASME B36.10	API 5L Gr X65 PSL 2 WLD SAW
		18"	2.000"																		-
Fittings	90 LR Elbow	C 15-03	1" - 1 1/2"	According to pipe	-	ASME B16.9	ASTM A234 Gr WPB														
	45 LR Elbow	C 16-03																			
	90 SR Elbow	C 17-03																			
	Tee	C 20-03																			
	Cap	C 22-03																			
	Cross	C 24-03																			
	Weldolet	C 12-22																			
	Conc. Red	C 18-03	1 1/2"			-	BE	ASME B16.9	ASTM A234 Gr WPB												
	Ecc. Red	C 19-03																			
	Red Tee	C 21-03																			
	90 LR Elbow	C 15-22	2" - 18"			-	BE	MSS SP-75	ASTM A860 WPHY65												
	45 LR Elbow	C 16-22																			
	90 SR Elbow	C 17-22																			
	Conc. Red	C 18-22																			
	Ecc. Red	C 19-22																			
	Tee	C 20-22																			
	Red Tee	C 21-22																			
Cap	C 22-22																				
Cross	C 24-22																				
Nipple	Straight Nipple	N-S220	1" - 1 1/2"	According to pipe	-	BBE	ASTM A733	API 5L Gr B PSL 1 seamless													
	Swage Conc Nipple	N-C203	1 1/2"						-	BBE	MSS SP-95	ASTM A234 Gr WPB									
		N-C222	2" - 4"																		
	Swage Ecc Nipple	N-E203	1 1/2"						-	BBE	MSS SP-95	ASTM A860 WPHY65									
		N-E222	2" - 4"																		
Flanges	Welding Neck (WN)	F-2500-R2	1" - 1 1/2"	According to pipe	Class 2500	Ring Type Joint	ASME B16.5	ASTM A105													
		F-2500-RC	2" - 12"																		
	Blind	F-2500-S2	1" - 1 1/2"						-	BBE	MSS SP-95	ASTM A694 Gr F65									
		F-2500-SC	2" - 12"																		
	Compact WN	F-2500-UC	4" - 18"						-	BBE	MSS SP-95	ASTM A694 Gr F65									
Compact Blind	F-2500-VC	4" - 18"																			
Gasket	Ring-Joint	J-2500-AN	1" - 12"	-	Class 2500	Ring Type Joint	ASME B16.20	Carbon Steel													
		J-2500-BN	4" - 18"						-	BBE	MSS SP-95	ASTM A694 Gr F65									
Bolts & Nuts	Stud and Nuts	P-2500-12	7/8" - 2 3/4"	-	-	-	ASME B1.1	A193 B7M, Zn-Ni													
												A194 Gr 2H, Zn-Ni									

 PETROBRAS		OFFSHORE PRODUCTION FACILITIES				Doc: I-ET-3010.1M-1200-200-P4X-001	Revision: F	Sheet 1 of 2
		PIPING SPECIFICATION FOR TOPSIDE					Issued by: SRGE/ESUP	Code: ASME B31.3



Services (see notes): IW - De-Aerated Sea Water Injection; P - Process (non-corrosive hydrocarbon); PC - Process (Corrosive Hydrocarbon);	Material: Super Duplex	Class: 2500	Standard: H12
---	----------------------------------	-----------------------	-------------------------

Pressure Rating (see notes)

Temperature (°C)	-50	115								
Max Pressure (barg)	410	410								

Pipes and Fittings (see notes)

Items	Code	Size	Wall	Class	Ends	Standard	Material	
Pipes	T-303	1" - 1 1/2"	S-80S	-	PE	ASME B36.10/B36.19	ASTM A790 (UNS S32760) SML	
		2"			BE			
		3" - 4"						0.438"
		6"						0.625"
		8"						0.812"
	T-304	10"	0.875"		ASTM A928 (UNS S32760 Cl 1 or 3) WLD			
		12"	1.062"					
		14"	1.125"					
		16"	1.438"					
		18"	1.562"					
	20"	1.750"						
	24"	2.062"						
Fittings	Weldolet	C 12-30	1" - 10"	According to pipe	BE	MSS SP-97	ASTM A182 Gr F55 (UNS S32760)	
	90 LR Elbow	C 15-32	1" - 24"		-	ASME B16.9	ASTM A815 (UNS S32760)	
	45 LR Elbow	C 16-32						
	90 SR Elbow	C 17-32						
	Tee	C 20-32						
	Cap	C 22-32						
	Cross	C 24-32						
	Conc. Red	C 18-32						
	Ecc. Red	C 19-32						
Red Tee	C 21-32	1 1/2" - 24"						
Nipple	Straight Nipple	N-S231	1" - 1 1/2"	According to pipe	BBE	ASTM A733	ASTM A790 (UNS S32760)	
	Swage Conc Nipple	N-C232	1 1/2" - 4"			MSS SP-95	ASTM A815 (UNS S32760)	
	Swage Ecc Nipple	N-E232						
Flanges	Welding Neck (WN)	F-2500-RH	1" - 12"	According to pipe	Class 2500	Ring Type Joint	ASME B16.5	ASTM A182 Gr F55
	Blind	F-2500-SH						
	Compact WN	F-2500-UH	4" - 24"			IX seal ring	ISO 27509	
	Compact Blind	F-2500-VH						
Gasket	Ring-Joint	J-2500-AU	1" - 12"	-	Class 2500	Ring Type Joint	ASME B16.20	Duplex , ASTM A182 F51
		J-2500-BU	4" - 24"			Metallic Seal Joint	ISO 27509	
Bolts & Nuts	Stud and Nuts	P-2500-11	7/8" - 3 1/4"	-	-	-	ASME B1.1	A320 L7M, Zn-Ni
								A194 7L, Zn-Ni



		OFFSHORE PRODUCTION FACILITIES				Doc: I-ET-3010.1M-1200-200- P4X-001	Revision: F	Sheet 1 of 2
		PIPING SPECIFICATION FOR TOPSIDE					Issued by: SRGE/ESUP	Code: ASME B31.8

Services (see notes): P - Process (non-corrosive hydrocarbon); PC - Process (Corrosive Hydrocarbon);	Material: Super Duplex	Class: 2500	Standard: H12P
---	---------------------------	----------------	-------------------

Pressure Rating (see notes)										
Temperature (°C)	-50	38	115							
Max Pressure (barg)	410	410	410							

Pipes and Fittings (see notes)

Items	Code	Size	Wall	Class	Ends	Standard	Material				
Pipes	Pipe	T-303	1" - 1 1/2"	S-80S	-	PE	ASME B36.10/B36.19	ASTM A790 (UNS S32760) SML			
			2"								
			3"								
			4"								
			6"								
		T-304	8"	0.719"							
			10"	0.812"							
			12"	1.000"							
			14"	1.062"							
			18"	1.375"							
Fittings	90 LR Elbow	C15-32	1" - 3"	According to pipe	-	BE	ASME B16.9	ASTM A815 (UNS S32760)			
	45 LR Elbow	C16-32									
	90 SR Elbow	C17-32									
	Weldolet	C12-30	1" - 8"						MSS SP-97	ASTM A182 Gr F55 (UNS S32760)	
	Tee	C20-32	1" - 14"						ASME B16.9	ASTM A815 (UNS S32760)	
	Cap	C22-32									
	Cross	C24-32									
	Conc. Red	C18-32	1 1/2" - 3"						according to manufacturer	ASTM A790 (UNS S32760)	
	Ecc. Red	C19-32									
	Red Tee	C21-32	1 1/2" - 18"								
	3D 45 Bend	C33-31	4" - 8"								ASTM A928 (UNS S32760) CI 1 or 3
	5D 45 Bend	C34-31									
	3D 90 Bend	C35-31									
	5D 90 Bend	C36-31	10" - 18"								
	3D 45 Bend	C33-41									
	5D 45 Bend	C34-41									
	3D 90 Bend	C35-41									
	5D 90 Bend	C36-41	18"						ASME B16.9	ASTM A815 (UNS S32760)	
	Tee	C20-32									
	Cap	C22-32									
Cross	C24-32										
Nipple	Straight Nipple	N-S231	1" - 1 1/2"	According to pipe	-	BBE	ASTM A733	ASTM A790 (UNS S32760)			
Flanges	Welding Neck (WN)	F-2500-RH	1" - 12"	According to pipe	Class 2500	Ring Type Joint	ASME B16.5	ASTM A182 Gr F55			
	Blind	F-2500-SH									
	Compact WN	F-2500-UH	4" - 18"			IX seal ring	ISO 27509				
	Compact Blind	F-2500-VH									
Gasket	Ring-Joint	J-2500-AU	1" - 12"	-	Class 2500	Ring Type Joint	ASME B16.20	Duplex , ASTM A182 F51			
		J-2500-BU	4" - 18"			Metallic Seal Joint	ISO 27509				
Bolts & Nuts	Stud and Nuts	P-2500-11	7/8" - 2 3/4"	-	-	-	ASME B1.1	A320 L7M, Zn-Ni			
								A194 7L, Zn-Ni			

		OFFSHORE PRODUCTION FACILITIES	Doc: I-ET-3010.1M-1200-200-P4X-001	Revision: F	Sheet: 2 of 2
		PIPING SPECIFICATION FOR TOPSIDE			Material: Super Duplex

Valves (see notes)

Type	Size	CODE	Temp	Type	Size	CODE	Temp	Type	Size	CODE	Temp	Type	Size	CODE	Temp
Ball	1" - 1 1/2"	VES-2502-2-D308	0C to 120C	Ball	2" - 3"	VES-2500-2-D372	-50C to 200C	Ball	4" - 18"	VES-2510-2-D352	-30C to 150C	Double Ball	1" - 2"	VDE-2500-2-D304	-46C to 150C
		VES-2502-2-D309	-50C to 200C			VES-2500-3-D352	-30C to 150C			VES-2510-2-D370	-50C to 200C			VDE-2500-2-D305	-50C to 150C
		VES-2502-3-D309	-50C to 200C			VES-2500-3-D353	-30C to 150C			VES-2510-2-D372	-50C to 200C		VDE-2500-2-D315	-30C to 120C	
	VES-2500-2-D314	-30C to 150C	VES-2500-3-D372		-50C to 200C	VES-2510-3-D352	-30C to 150C			VDE-2500-2-D370	-50C to 200C				
	VES-2500-2-D318	-30C to 120C	VES-2500-3-D373		-50C to 200C	VES-2510-3-D353	-30C to 150C			VDE-2510-2-D315	-30C to 120C				
	VES-2500-2-D334	-46C to 120C	VES-2510-2-D314		-30C to 120C	VES-2510-3-D372	-50C to 200C			VDE-2510-2-D370	-50C to 200C				
	VES-2500-2-D338	-46C to 120C	VES-2510-2-D318		-30C to 120C	VES-2510-3-D373	-50C to 200C		Gate	1" - 1 1/2"	VGA-2501-2-D301		-50C to 150C		
	VES-2500-2-D350	-30C to 150C	VES-2510-2-D334		-46C to 120C	VES-2510-4-D354	-30C to 150C		Check	2" - 3"	VRE-2500-2-D315		-50C to 150C		
	VES-2500-2-D352	-30C to 150C	VES-2510-2-D338		-46C to 120C	VES-2510-4-D374	-50C to 200C			4" - 12"	VRE-2510-2-D315		-50C to 150C		
	VES-2500-2-D370	-50C to 200C	VES-2510-2-D350		-30C to 150C	Double Ball	1" - 2"		VDE-2500-2-D303	-46C to 150C					



Branch (see notes)

RUN SIZE	1	TEE																		
	1.5	RTEE	TEE																	
	2	RTEE	RTEE	TEE																
	3	WOL	RTEE	RTEE	TEE															
	4	WOL	WOL	RTEE	RTEE	TEE														
	6	WOL	WOL	WOL	RTEE	RTEE	TEE													
	8	WOL	WOL	WOL	WOL	RTEE	RTEE	TEE												
	10	WOL	WOL	WOL	WOL	WOL	RTEE	RTEE	TEE											
	12	WOL	WOL	WOL	WOL	WOL	RTEE	RTEE	RTEE	TEE										
	14	WOL	WOL	WOL	WOL	WOL	RTEE	RTEE	RTEE	TEE										
	16	WOL	WOL	WOL	WOL	WOL	RTEE	RTEE	RTEE	RTEE	TEE									
	18	WOL	WOL	WOL	WOL	WOL	WOL	RTEE	RTEE	RTEE	RTEE	TEE								
		1	1.5	2	3	4	6	8	10	12	14	16	18							
		BRANCH SIZE																		

WOL - Weldolet
TEE - Tee
RTEE - Red Tee
HC - Half Coupling
SOC - Sockolet

Notes

1	On the spec valve list, it may have valves codes which contain values of process data lower than spec limits. It shall be verified all valve process data (e.g.: pressure, temperature) in order to specify it according the design premisses.
2	See Annex A for valves requirements and general selection criteria.
3	Bolts,nuts and gaskets (only RTJ gaskets) must be Zn-Ni coated according to Annex B.
4	See Annex C for instruments, drains and vents typical piping arrangement.
5	Flanges ≤ 1 1/2" may be used, if strictly necessary.
6	See Annex E for Isolation gasket specifications.
7	Welding and Welding Inspection activities shall follow the requeriments of these documents: I-ET-3010.00-1200-955-P4X-001-Welding and I-ET-3010.00-1200-955-P4X-002-Requirements for Welding Inspection
8	All valves, pipes and components specified for hydrogen sulfide service shall be in accordance with ISO 15156 requirements.
26	See Annex A for valve casting qualification requirements.
27	See Annex D to check the piping spec range application for H2S and CO2 service.
44	Only pipes NPS ≥ 4 are designed according to ASME B31.4/31.8.
48	SuperDuplex Stainless Steel external coating shall be applied for the temperature limits acc. to I-ET-3010.00-1200-956-P4X-002 - General Painting.
67	Branches with diameter greater than or equal to half the nominal diameter of the pipe shall be fitted with guide bars according to I-ET-3010.00-1200-295-P4X-001- Requirements for Pig L/R Design
77	The maximum reduction of wall thickness shall be 15% and 10% for 3d and 5d bends, respectively.
120	Wafer valves are not to be used with flammable or combustible services, according to NFPA definition.
122	Inspection of pipe and piping components shall follow ASTM A923 requirements.
125	Materials shall follow the requirements of IOGP S-563- Material Data Sheets for Piping and Valve Components. Coating for bolts and nuts shall follow spec note number 3.
131	For PSV assembly shall be used ASME flanges until NPS 12.

		OFFSHORE PRODUCTION FACILITIES				Doc: I-ET-3010.1M-1200-200- P4X-001	Revision: F	Sheet 1 of 2
		PIPING SPECIFICATION FOR TOPSIDE					Issued by: SRGE/ESUP	Code: ASME B31.3



Services (see notes): CNI - Corrosive Chemical Injection (Except Sodium Hypochlorite); PC - Process (Corrosive Hydrocarbon);	Material: Duplex	Class: 2500	Standard: H16
---	---------------------	----------------	------------------

Pressure Rating (see notes)

Temperature (°C)	-50	130									
Max Pressure (barg)	365	365									

Pipes and Fittings (see notes)

Items	Code	Size	Wall	Class	Ends	Standard	Material	
Pipes	T-301	1" - 1 1/2"	S-80S	-	PE	ASME B36.10/B36.19	ASTM A790 (UNS S31803) SML	
		2"	0.250"		BE			
		3" - 4"	0.438"					
		6"	0.625"					
		8"	0.875"					
	T-302	10"	0.938"				ASTM A928 (UNS S31803 Cl 1 or 3) WLD	
		12"	1.062"					
		14"	1.250"					
		16"	1.438"					
		18"	1.562"					
		20"	1.750"					
		24"	2.062"					
Fittings	Weldolet	C 12-27	1" - 10"	According to pipe	BE	MSS SP-97	ASTM A182 Gr F51 (UNS S31803)	
	90 LR Elbow	C 15-29	1" - 24"		-	ASME B16.9	ASTM A815 (UNS S31803)	
	45 LR Elbow	C 16-29						
	90 SR Elbow	C 17-29						
	Tee	C 20-29						
	Cap	C 22-29						
	Cross	C 24-29						
	Conc. Red	C 18-29			1 1/2" - 24"			
	Ecc. Red	C 19-29						
Red Tee	C 21-29	2" - 24"						
Nipple	Straight Nipple	N-S228	1" - 1 1/2"	According to pipe	BBE	ASTM A733	ASTM A790 (UNS S31803)	
	Swage Conc Nipple	N-C229	1 1/2" - 4"		MSS SP-95	ASTM A815 (UNS S31803)		
	Swage Ecc Nipple	N-E229						
Flanges	Welding Neck (WN)	F-2500-RG	1" - 12"	According to pipe	Class 2500	Ring Type Joint	ASME B16.5	ASTM A182 Gr F51
	Blind	F-2500-SG						
	Compact WN	F-2500-UG	4" - 24"		IX seal ring	ISO 27509		
	Compact Blind	F-2500-VG						
Gasket	Ring-Joint	J-2500-AU	1" - 12"	-	Class 2500	Ring Type Joint	ASME B16.20	Duplex , ASTM A182 F51
		J-2500-BU	4" - 24"			Metallic Seal Joint	ISO 27509	
Bolts & Nuts	Stud and Nuts	P-2500-11	7/8" - 3 1/4"	-	-	-	ASME B1.1	A320 L7M, Zn-Ni
							A194 7L, Zn-Ni	

		OFFSHORE PRODUCTION FACILITIES				Doc: I-ET-3010.1M-1200-200- P4X-001	Revision: F	Sheet 1 of 2
		PIPING SPECIFICATION FOR TOPSIDE					Issued by: SRGE/ESUP	Code: ASME B31.3



Services (see notes): IW - De-Aerated Sea Water Injection; PC - Process (Corrosive Hydrocarbon);	Material: CS Inconel Clad.	Class: 2500	Standard: H30
---	----------------------------------	----------------	------------------

Pressure Rating (see notes)

Temperature (°C)	-20	115								
Max Pressure (barg)	344	344								

Pipes and Fittings (see notes)

Items		Code	Size	Wall	Class	Ends	Standard	Material		
Pipes	Pipe	T-203	1" - 1 1/2" 2" - 3"	S-80S	-	PE	ASME B36.10/B36.19	ASTM B444 Gr 1 (UNS N06625) SML		
		T-107	4" - 14" 16" - 24"	S-160		BE			ASME B36.10	API 5L Gr X65 PSL 2 (SML or WLD SAW) API 5L Gr X65 PSL 2 WLD SAW
		Fittings	Weldolet	C12-33		1" - 3"	According to pipe	-	BE	MSS SP-97
90 LR Elbow	C15-33		1 1/2" - 3"	BE	ASME B16.9				ASTM A694 Gr F65	
45 LR Elbow	C16-33									
90 SR Elbow	C17-33									
Tee	C20-33									
Cap	C22-33									
Cross	C24-33									
Weldolet	C12-22		4" - 24"	BE	MSS SP-75	ASTM A860 WPHY65				
Conc. Red	C18-33									
Ecc. Red	C19-33									
Red Tee	C21-33									
90 LR Elbow	C15-22									
45 LR Elbow	C16-22									
90 SR Elbow	C17-22		BE	MSS SP-75	ASTM A860 WPHY65					
Conc. Red	C18-22									
Ecc. Red	C19-22									
Tee	C20-22									
Red Tee	C21-22									
Cap	C22-22									
Cross	C24-22									
Nipple	Straight Nipple	N-S239	1" - 1 1/2"	According to pipe	-	BBE	ASTM A733	ASTM B444 Gr 1 (UNS N06625)		
	Swage Conc Nipple	N-C233	1 1/2" - 4"				MSS SP-95	ASTM B366 (UNS N06625)		
	Swage Ecc Nipple	N-E233								
Flanges	Welding Neck (WN)	F-2500-RL	1" - 3"	According to pipe	Class 2500	Ring Type Joint	ASME B16.5	ASTM B564 (UNS N06625)		
		F-2500-RD	4" - 12"					ASTM A694 Gr F65 Cladded		
	Blind	F-2500-SL	1" - 3"					ASTM B564 (UNS N06625)		
		F-2500-SD	4" - 12"					ASTM A694 Gr F65 Cladded		
	Compact WN	F-2500-UD	4" - 24"					IX seal ring	ISO 27509	ASTM A694 Gr F65 Cladded
Compact Blind	F-2500-VD									
Bolts & Gasket	Ring-Joint	J-2500-AV	1" - 12"	-	Class 2500	Ring Type Joint	ASME B16.20	Inconel		
		J-2500-BV	4" - 24"			Metallic Seal Joint	ISO 27509			
Bolts & Nuts	Stud and Nuts	P-2500-12	7/8" - 3 1/4"	-	-	-	ASME B1.1	A193 B7M, Zn-Ni		
								A194 Gr 2H, Zn-Ni		

		OFFSHORE PRODUCTION FACILITIES				Doc: I-ET-3010.1M-1200-200- P4X-001	Revision: F	Sheet 1 of 2
		PIPING SPECIFICATION FOR TOPSIDE					Issued by: SRGE/ESUP	Code: ASME B31.8



Services (see notes): PC - Process (Corrosive Hydrocarbon);	Material: CS Inconel Clad.	Class: 2500	Standard: H30P
--	----------------------------------	----------------	-------------------

Pressure Rating (see notes)

Temperature (°C)	-20	115								
Max Pressure (barg)	344	344								

Pipes and Fittings (see notes)

Items	Code	Size	Wall	Class	Ends	Standard	Material	
Pipes	T-203	1" - 1 1/2"	S-80S	-	PE	ASME B36.10/B36.19	ASTM B444 Gr 1 (UNS N06625) SML	
		2" - 3"			BE			ASME B36.10
	4" - 10"	S-120						
	12"		XXS					
	T-107	14"	S-120					
16"		1.250"						
		18" - 20"	S-140					
Fittings	Weldolet	C 12-33	According to pipe	-	BE	MSS SP-97	ASTM B366 (UNS N06625)	
	90 LR Elbow	C 15-33			-	ASME B16.9		
	45 LR Elbow	C 16-33						
	90 SR Elbow	C 17-33			1" - 3"	ASME B16.9		ASTM B366 (UNS N06625)
	Tee	C 20-33						
	Cap	C 22-33						
	Cross	C 24-33						
	Weldolet	C 12-22			1" - 8"	MSS SP-97		ASTM A694 Gr F65
	Conc. Red	C 18-33			1 1/2" - 3"	ASME B16.9		ASTM B366 (UNS N06625)
	Ecc. Red	C 19-33						
	Red Tee	C 21-33			4" - 20"	MSS SP-75		ASTM A860 WPHY65
	Tee	C 20-22				according to manufacturer		API 5L Gr X65 PSL 2
	Red Tee	C 21-22						
	Cap	C 22-22						
	3D 45 Bend	C 33-21						
5D 45 Bend	C 34-21							
3D 90 Bend	C 35-21							
5D 90 Bend	C 36-21							
Nipple	Straight Nipple	N-S239	1" - 1 1/2"	According to pipe	-	BBE	ASTM A733	ASTM B444 Gr 1 (UNS N06625)
	Swage Conc Nipple	N-C233	1 1/2" - 4"			MSS SP-95	ASTM B366 (UNS N06625)	
	Swage Ecc Nipple	N-E233						
Flanges	Welding Neck (WN)	F-2500-RL	1" - 3"	According to pipe	Class 2500	Ring Type Joint	ASME B16.5	ASTM B564 (UNS N06625)
		F-2500-RD	4" - 12"					ASTM A694 Gr F65 Cladded
	F-2500-SL	1" - 3"	ASTM B564 (UNS N06625)					
	Blind	F-2500-SD	4" - 12"			IX seal ring	ISO 27509	ASTM A694 Gr F65 Cladded
		F-2500-UD	4" - 20"					
Compact WN	F-2500-VD							
Compact Blind								
Bolt & Gasket	Ring-Joint	J-2500-AV	1" - 12"	-	Class 2500	Ring Type Joint	ASME B16.20	Inconel
		J-2500-BV	4" - 20"			Metallic Seal Joint	ISO 27509	
Bolts & Nuts	Stud and Nuts	P-2500-12	7/8" - 2 3/4"	-	-	-	ASME B1.1	A193 B7M, Zn-Ni
								A194 Gr 2H, Zn-Ni

		OFFSHORE PRODUCTION FACILITIES				Doc: I-ET-3010.1M-1200-200- P4X-001	Revision: F	Sheet 1 of 2
		PIPING SPECIFICATION FOR TOPSIDE						Issued by: SRGE/ESUP



Services (see notes): CNI - Corrosive Chemical Injection (Except Sodium Hypochlorite); P - Process (non-corrosive hydrocarbon); PC - Process (Corrosive Hydrocarbon);	Material: Super Duplex	Class: 10000	Standard: J12
--	----------------------------------	------------------------	-------------------------

Pressure Rating (see notes)

Temperature (°C)	-50	38	100							
Max Pressure (barg)	605	605	605							

Pipes and Fittings (see notes)

Items	Code	Size	Wall	Class	Ends	Standard	Material
Pipes	T-303	1"	S-80S	-	PE	ASME B36.10/B36.19	ASTM A790 (UNS S32760) SML
		1 1/2"	0.281"				
		2"	0.344"				
		3"	0.600"				
		4"	0.674"				
		6"	0.864"				
	T-304	8"	1.125"		BE		
		10"	1.250"				
		12"	1.438"				
14" - 16"	2.000"						
Fittings	Weldolet	C 12-30	1" - 6"	According to pipe	BE	MSS SP-97	ASTM A182 Gr F55 (UNS S32760)
	90 LR Elbow	C 15-32	1" - 16"		-	ASME B16.9	ASTM A815 (UNS S32760)
	45 LR Elbow	C 16-32					
	90 SR Elbow	C 17-32					
	Tee	C 20-32					
	Cap	C 22-32					
	Cross	C 24-32					
	Conc. Red	C 18-32					
	Ecc. Red	C 19-32					
	Red Tee	C 21-32					
Nipple	Straight Nipple	N-S231	1" - 1 1/2"	According to pipe	BBE	ASTM A733	ASTM A790 (UNS S32760)
	Swage Conc Nipple	N-C232	1 1/2" - 4"		MSS SP-95	ASTM A815 (UNS S32760)	
	Swage Ecc Nipple	N-E232					
Flange	Flange WN API 6BX	F-10000-RH	1" - 16"	API 10000	Ring Type Joint	API 6A	ASTM A182 Gr F55
	Blind API 6BX	F-10000-SH					
Ring-Joint	J-10000-AU	1" - 16"	-	API 10000	Ring Type Joint	API 6A	Duplex , ASTM A182 F51
Bolts & Nuts	Stud and Nuts	P-10000-07	3/4" - 1 3/4"	-	-	-	ASME B1.1
							A193 B7, Zn-Ni
							A194 Gr 2H, Zn-Ni



		OFFSHORE PRODUCTION FACILITIES				Doc: I-ET-3010.1M-1200-200- P4X-001	Revision: F	Sheet 1 of 2
		PIPING SPECIFICATION FOR TOPSIDE						Issued by: SRGE/ESUP

Services (see notes): DOH - Carbon Dioxide w/ Hydrocarbon; P - Process (non-corrosive hydrocarbon); PC - Process (Corrosive Hydrocarbon);	Material: Super Duplex	Class: 10000	Standard: J12P
--	---------------------------	-----------------	-------------------

Pressure Rating (see notes)										
Temperature (°C)	-50	38	100							
Max Pressure (barg)	605	605	605							

Pipes and Fittings (see notes)

Items	Code	Size	Wall	Class	Ends	Standard	Material	
Pipes	T-303	1"	S-80S	-	PE	ASME B36.10/B36.19	ASTM A790 (UNS S32760) SML	
		1 1/2"	0.281"					
		2"	0.344"					
		3"	0.600"					
		T-304	4"		0.531"			BE
			6"		0.750"			
			8"		1.000"			
			10"		1.250"			
Fittings	90 LR Elbow	C 15-32	According to pipe	-	BE	ASME B16.9	ASTM A815 (UNS S32760)	
	45 LR Elbow	C 16-32						
	90 SR Elbow	C 17-32						
	Weldolet	C 12-30						
	Tee	C 20-32						
	Cap	C 22-32						
	Cross	C 24-32						
	Conc. Red	C 18-32						
	Ecc. Red	C 19-32						
	Red Tee	C 21-32						
	3D 45 Bend	C 33-31						
	5D 45 Bend	C 34-31						
	3D 90 Bend	C 35-31						
	5D 90 Bend	C 36-31						
3D 45 Bend	C 33-41							
5D 45 Bend	C 34-41							
3D 90 Bend	C 35-41							
5D 90 Bend	C 36-41							
Nipple	Straight Nipple	N-S231	According to pipe	-	BBE	ASTM A733	ASTM A790 (UNS S32760)	
	Swage Conc Nipple	N-C232						
	Swage Ecc Nipple	N-E232						
Flanges	Flange WN API 6BX	F-10000-RH	According to pipe	API 10000	Ring Type Joint	API 6A	ASTM A182 Gr F55	
	Blind API 6BX	F-10000-SH						
Gasket	Ring-Joint	J-10000-AU	1" - 14"	-	API 10000	Ring Type Joint	API 6A	Duplex , ASTM A182 F51
A194 Gr 2H, Zn-Ni								

		OFFSHORE PRODUCTION FACILITIES				Doc: I-ET-3010.1M-1200-200-P4X-001	Revision: F	Sheet: 2 of 2
		PIPING SPECIFICATION FOR TOPSIDE					Material: Super Duplex	Class: 10000

Valves (see notes)

Type	Size	CODE	Temp	Type	Size	CODE	Temp	Type	Size	CODE	Temp	Type	Size	CODE	Temp
Ball	1" - 2"	VES-10000-2-D334	-50C to 150C	Double Ball	1" - 2"	VDE-10000-2-D303	-50C to 150C	Gate	1" - 14"	VGA-10000-3-D311	-50C to 150C	Check	1" - 2"	VRE-10000-2-D325	-50C to 120C
Double Ball	1" - 2"	VDE-10000-2-D301	-30C to 150C	Double Ball	3"	VDE-10000-2-D371	-50C to 150C	Gate	1 1/2" - 14"	VGA-10000-4-D311	-50C to 150C				



Branch (see notes)

RUN SIZE	1	TEE	1.5	RTEE	TEE	2	RTEE	RTEE	TEE	3	WOL	RTEE	RTEE	TEE	4	WOL	WOL	RTEE	RTEE	TEE	6	WOL	WOL	WOL	RTEE	RTEE	TEE	8	WOL	WOL	WOL	WOL	RTEE	RTEE	TEE	10	WOL	WOL	WOL	WOL	WOL	RTEE	RTEE	TEE	12	WOL	WOL	WOL	WOL	WOL	WOL	RTEE	RTEE	TEE	14	WOL	WOL	WOL	WOL	WOL	WOL	WOL	RTEE	RTEE	TEE
		1	1.5	2	3	4	6	8	10	12	14	BRANCH SIZE																																																					

- WOL - Weldolet
- TEE - Tee
- RTEE - Red Tee
- HC - Half Coupling
- SOC - Sockolet

Notes

1	On the spec valve list, it may have valves codes which contain values of process data lower than spec limits. It shall be verified all valve process data (e.g.: pressure, temperature) in order to specify it according the design premisses.
2	See Annex A for valves requirements and general selection criteria.
3	Bolts, nuts and gaskets (only RTJ gaskets) must be Zn-Ni coated according to Annex B.
4	See Annex C for instruments, drains and vents typical piping arrangement.
6	See Annex E for Isolation gasket specifications.
7	Welding and Welding Inspection activities shall follow the requirements of these documents: I-ET-3010.00-1200-955-P4X-001-Welding and I-ET-3010.00-1200-955-P4X-002-Requirements for Welding Inspection
8	All valves, pipes and components specified for hydrogen sulfide service shall be in accordance with ISO 15156 requirements.
27	See Annex D to check the piping spec range application for H2S and CO2 service.
44	Only pipes NPS ≥ 4 are designed according to ASME B31.4/31.8.
48	SuperDuplex Stainless Steel external coating shall be applied for the temperature limits acc. to I-ET-3010.00-1200-956-P4X-002 - General Painting.
67	Branches with diameter greater than or equal half the nominal diameter of the pipe shall be fitted with guide bars according to I-ET-3010.00-1200-295-P4X-001- Requirements for Pig L/R Design
77	The maximum reduction of wall thickness shall be 15% and 10% for 3d and 5d bends, respectively.
120	Wafer valves are not to be used with flammable or combustible services, according to NFPA definition.
122	Inspection of pipe and piping components shall follow ASTM A923 requirements.
125	Materials shall follow the requirements of IOGP S-563- Material Data Sheets for Piping and Valve Components. Coating for bolts and nuts shall follow spec note number 3.

		OFFSHORE PRODUCTION FACILITIES				Doc: I-ET-3010.1M-1200-200- P4X-001	Revision: F	Sheet 1 of 2
		PIPING SPECIFICATION FOR TOPSIDE						Issued by: SRGE/ESUP



Services (see notes): P - Process (non-corrosive hydrocarbon); PC - Process (Corrosive Hydrocarbon);	Material: Inconel	Class: 10000	Standard: J40
---	----------------------	-----------------	------------------

Pressure Rating (see notes)

Temperature (°C)	-100	0	100	155							
Max Pressure (barg)	604	604	604	604							

Pipes and Fittings (see notes)

Items	Code	Size	Wall	Class	Ends	Standard	Material		
Pipes	Pipe	T-203	1"	S-80S	-	PE	ASME B36.10/B36.19	ASTM B444 Gr 1 (UNS N06625) SML	
			1 1/2"	0.281"					
			2"	0.344"					
			3"	0.438"					
			4"	0.531"					
			6"	0.864"					
			8"	1.062"					
			10"	1.250"					
Fittings	Weldolet	C 12-33	1" - 6"	According to pipe	-	BE	MSS SP-97	ASTM B366 (UNS N06625)	
	90 LR Elbow	C 15-33	1" - 14"			-	BE		ASME B16.9
	45 LR Elbow	C 16-33							
	90 SR Elbow	C 17-33							
	Tee	C 20-33							
	Cap	C 22-33							
	Cross	C 24-33							
	Conc. Red	C 18-33							
	Ecc. Red	C 19-33							
	Nipple	Straight Nipple	N-S239			1" - 1 1/2"	According to pipe		-
Swage Conc Nipple		N-C233	2" - 4"	MSS SP-95	ASTM B366 (UNS N06625)				
Swage Ecc Nipple		N-E233							
Flange	Flange WN API 6BX	F-10000-RL	1" - 14"	According to pipe	API 10000	Ring Type Joint	API 6A	ASTM B564 (UNS N06625)	
	Blind API 6BX	F-10000-SL							
Ring-Joint	J-10000-AV	1" - 14"	-	API 10000	Ring Type Joint	API 6A	Inconel		
Bolts & Nuts	Stud and Nuts	P-10000-09	3/4" - 1 1/2"	-	-	-	ASME B1.1	A320 L43, Zn-Ni	
								A194 7L, Zn-Ni	

		OFFSHORE PRODUCTION FACILITIES				Doc: I-ET-3010.1M-1200-200- P4X-001	Revision: F	Sheet 1 of 2
		PIPING SPECIFICATION FOR TOPSIDE						Issued by: SRGE/ESUP



Services (see notes): P - Process (non-corrosive hydrocarbon); PC - Process (Corrosive Hydrocarbon);	Material: Inconel	Class: 10000	Standard: J40P
---	----------------------	-----------------	-------------------

Pressure Rating (see notes)

Temperature (°C)	-100	0	100	155							
Max Pressure (barg)	604	604	604	604							

Pipes and Fittings (see notes)

Items	Code	Size	Wall	Class	Ends	Standard	Material	
Pipes	Pipe	T-203	1"	S-80S	-	PE	ASME B36.10/B36.19	ASTM B444 Gr 1 (UNS N06625) SML
			1 1/2"	0.281"				
			2"	0.344"				
			3"	0.438"				
			4"	0.531"				
			6"	0.864"				
			8"	1.062"				
			10"	1.250"				
			12"	1.594"				
14"	1.781"							
Fittings	90 LR Elbow	C15-33	1" - 3"	According to pipe	-	ASME B16.9	ASTM B366 (UNS N06625)	
	45 LR Elbow	C16-33						
	90 SR Elbow	C17-33						
	Weldolet	C12-33	1" - 6"			ASME B16.9		
	Tee	C20-33						
	Cap	C22-33						
	Cross	C24-33	1" - 14"			according to manufacturer		
	Conc. Red	C18-33						
	Ecc. Red	C19-33						
	Red Tee	C21-33	1 1/2" - 14"			ASTM B444 Gr 1 (UNS N06625)		
	3D 45 Bend	C33-39						
	5D 45 Bend	C34-39						
	3D 90 Bend	C35-39						
5D 90 Bend	C36-39							
Nipple	Straight Nipple	N-S239	1" - 1 1/2"	According to pipe	-	BBE	ASTM A733	ASTM B444 Gr 1 (UNS N06625)
	Swage Conc Nipple	N-C233	2" - 4"					
	Swage Ecc Nipple	N-E233						
Flanges	Flange WN API 6BX	F-10000-RL	1" - 14"	According to pipe	API 10000	Ring Type Joint	API 6A	ASTM B564 (UNS N06625)
	Blind API 6BX	F-10000-SL						
Gaskets	Ring-Joint	J-10000-AV	1" - 14"	-	API 10000	Ring Type Joint	API 6A	Inconel
Bolts & Nuts	Stud and Nuts	P-10000-09	3/4" - 1 1/2"	-	-	-	ASME B1.1	A320 L43, Zn-Ni
								A194 7L, Zn-Ni

		OFFSHORE PRODUCTION FACILITIES				Doc: I-ET-3010.1M-1200-200-P4X-001	Revision: F	Sheet: 2 of 2
		PIPING SPECIFICATION FOR TOPSIDE					Material: Inconel	Class: 10000

Valves (see notes)

Type	Size	CODE	Temp	Type	Size	CODE	Temp	Type	Size	CODE	Temp	Type	Size	CODE	Temp
Double Ball	1" - 2"	VDE-10000-2-N101	-30C to 150C	Double Ball	1" - 2"	VDE-10000-2-N103	-100C to 150C	Double Ball	3"	VDE-10000-2-N171	-50C to 150C	Check	1" - 12"	VRE-10000-2-N125	-100C to 200C
		VDE-10000-2-N102				VDE-10000-2-N104				VGA-10000-3-N111				-100C to 155C	

Branch (see notes)



RUN SIZE	1	TEE	1.5	RTEE	TEE	2	RTEE	RTEE	TEE	3	WOL	RTEE	RTEE	TEE	4	WOL	WOL	RTEE	RTEE	TEE	6	WOL	WOL	WOL	RTEE	RTEE	TEE	8	WOL	WOL	WOL	WOL	RTEE	RTEE	TEE	10	WOL	WOL	WOL	WOL	WOL	RTEE	RTEE	TEE	12	WOL	WOL	WOL	WOL	WOL	WOL	RTEE	RTEE	TEE	14	WOL	WOL	WOL	WOL	WOL	WOL	WOL	RTEE	RTEE	TEE
	1	1.5	2	3	4	6	8	10	12	14																																																							

BRANCH SIZE

- WOL - Weldolet
- TEE - Tee
- RTEE - Red Tee
- HC - Half Coupling
- SOC - Sockolet

Notes



1	On the spec valve list, it may have valves codes which contain values of process data lower than spec limits. It shall be verified all valve process data (e.g.: pressure, temperature) in order to specify it according the design premisses.
2	See Annex A for valves requirements and general selection criteria.
3	Bolts, nuts and gaskets (only RTJ gaskets) must be Zn-Ni coated according to Annex B.
4	See Annex C for instruments, drains and vents typical piping arrangement.
5	Flanges ≤ 1 1/2" may be used, if strictly necessary.
6	See Annex E for Isolation gasket specifications.
7	Welding and Welding Inspection activities shall follow the requirements of these documents: I-ET-3010.00-1200-955-P4X-001-Welding and I-ET-3010.00-1200-955-P4X-002-Requirements for Welding Inspection
8	All valves, pipes and components specified for hydrogen sulfide service shall be in accordance with ISO 15156 requirements.
67	Branches with diameter greater than or equal to half the nominal diameter of the pipe shall be fitted with guide bars according to I-ET-3010.00-1200-295-P4X-001- Requirements for Pig L/R Design
77	The maximum reduction of wall thickness shall be 15% and 10% for 3d and 5d bends, respectively.
101	Charpy impact test is required for low temperature services materials in accordance with ASTM B 444.
102	Charpy impact test is required for low temperature services materials in accordance with ASTM B 564.
120	Wafer valves are not to be used with flammable or combustible services, according to NFPA definition.
125	Materials shall follow the requirements of IOGP S-563- Material Data Sheets for Piping and Valve Components. Coating for bolts and nuts shall follow spec note number 3.

		OFFSHORE PRODUCTION FACILITIES				Doc: I-ET-3010.1M-1200-200- P4X-001	Revision: F	Sheet 1 of 2
		PIPING SPECIFICATION FOR TOPSIDE					Issued by: SRGE/ESUP	Code: ASME B31.3

Services (see notes): BG - Inert Gas; DW - Distilled Water; IA - Instrumentation Air; IN - Instrumentation Nitrogen; PW - Potable Water;	Material: SS316/316L	Class: 150	Standard: R3B
---	-------------------------	---------------	------------------

Pressure Rating (see notes)										
Temperature (°C)	0	38	50	60						
Max Pressure (barg)	19.0	19.0	18.4	17.9						

Pipes and Fittings (see notes)									
	Items	Code	Size	Wall	Class	Ends	Standard	Material	
Pipes	Pipe	T-322	¾" - 1 ½"	S-80S	-	PE	ASME B36.19	ASTM A312 TP 316/316L SML	
		T-323	2"			BE	ASME B36.10/B36.19	ASTM A358 Type 316/316L Cl 1 or 3 WLD	
			3" - 6"	S-40S					
Fittings	45 Elbow GMC Type I	C70-43	¾" - 6"	-	-	GMC Type I	ASTM F1476/ISO 15837	ASTM A182 Gr F316/316L	
	90 Elbow GMC Type I	C71-43							
	Coupling GMC Type I	C72-43							
	Tee GMC Type I	C73-43							
	Cap GMC Type I	C74-43							
Bolts & Gasket Flanges	Blind	F-150-LX	¾" - 6"	According to pipe	Class 150	Raised Face	ASME B16.5	ASTM A182 Gr F316/316L	
	Flange GMC Type I	F-150-5X							
Bolts & Nuts	Spiral-Wound	J-150-EH	¾" - 6"	-	Class 150	Raised Face	ASME B16.20	AISI 316/graphite	
	Stud and Nuts	P-150-07	¾" - 1 ½"	-	-	-	ASME B1.1	A193 B7, Zn-Ni A194 Gr 2H, Zn-Ni	

		OFFSHORE PRODUCTION FACILITIES				Doc: I-ET-3010.1M-1200-200-P4X-001	Revision: F	Sheet: 2 of 2
		PIPING SPECIFICATION FOR TOPSIDE						Material: SS316/316L

Valves (see notes)

Type	Size	CODE	Temp	Type	Size	CODE	Temp	Type	Size	CODE	Temp	Type	Size	CODE	Temp
Needle	3/4" - 1 1/2"	VAG-3000-1-S201	-100C to 200C	Ball	2" - 6"	VES-150-1-S210	-30C to 150C	Gate	2" - 6"	VGA-150-1-S201	-46C to 400C	Check	3/4" - 1 1/2"	VRE-800-1-S202	-100C to 400C
Ball	3/4" - 1 1/2"	VES-801-1-S201	-30C to 150C	Gate	3/4" - 1 1/2"	VGA-801-1-S201	-46C to 400C	Globe	2" - 6"	VGL-150-1-S201	-29C to 400C		2" - 6"	VRE-150-1-S211	0C to 150C

Branch (see notes)

RUN SIZE	0.5	TEE														
	0.75	RTEE	RTEE	TEE												
	1	RTEE	RTEE	RTEE	TEE											
	1.5	RTEE	RTEE	RTEE	RTEE	TEE										
	2	RTEE	RTEE	RTEE	RTEE	RTEE	TEE									
	3	RTEE	RTEE	RTEE	RTEE	RTEE	RTEE	TEE								
	4	RTEE	RTEE	RTEE	RTEE	RTEE	RTEE	RTEE	TEE							
6	RTEE	RTEE	RTEE	RTEE	RTEE	RTEE	RTEE	RTEE	TEE							
	0.5	0.75	1	1.5	2	3	4	6	BRANCH SIZE							

WOL - Weldolet

TEE - Tee



RTEE - Red Tee

HC - Half Coupling

SOC - Sockolet

Notes

2	See Annex A for valves requirements and general selection criteria.
3	Bolts, nuts and gaskets (only RTJ gaskets) must be Zn-Ni coated according to Annex B.
91	Specific tools shall be used to assembly piping fittings, therefore is mandatory manufacturer assistance.
125	Materials shall follow the requirements of IOGP S-563- Material Data Sheets for Piping and Valve Components. Coating for bolts and nuts shall follow spec note number 3.

		OFFSHORE PRODUCTION FACILITIES				Doc: I-ET-3010.1M-1200-200- P4X-001	Revision: F	Sheet 1 of 2
		PIPING SPECIFICATION FOR TOPSIDE					Issued by: SRGE/ESUP	Code: ASME B31.3



Services (see notes): BG - Inert Gas; DW - Distilled Water; IA - Instrumentation Air; IN - Instrumentation Nitrogen; PW - Potable Water;	Material: SS316/316L	Class: 300	Standard: R3C
---	-------------------------	---------------	------------------

Pressure Rating (see notes)

Temperature (°C)	0	60								
Max Pressure (barg)	40	40								

Pipes and Fittings (see notes)

Items		Code	Size	Wall	Class	Ends	Standard	Material
Pipes	Pipe	T-322	¾" - 1 ½"	S-80S	-	PE	ASME B36.19	ASTM A312 TP 316/316L SML
		T-323	2"			BE	ASME B36.10/B36.19	ASTM A358 Type 316/316L Cl 1 or 3 WLD
Fittings	45 Elbow GMC Type I	C70-43	¾" - 6"	-	-	GMC Type I	ASTM F1476/ISO 15837	ASTM A182 Gr F316/316L
	90 Elbow GMC Type I	C71-43						
	Coupling GMC Type I	C72-43						
	Tee GMC Type I	C73-43						
	Cap GMC Type I	C74-43						
Bolts & Gaskets/Flanges	Blind	F-300-LX	¾" - 6"	According to pipe	Class 300	Raised Face	ASME B16.5	ASTM A182 Gr F316/316L
	Flange GMC Type I	F-300-5X						
Bolts & Nuts	Spiral-Wound	J-300-EH	¾" - 6"	-	Class 300	Raised Face	ASME B16.20	AISI 316/graphite
	Stud and Nuts	P-300-07						
								A193 B7, Zn-Ni
								A194 Gr 2H, Zn-Ni

		OFFSHORE PRODUCTION FACILITIES				Doc: I-ET-3010.1M-1200-200-P4X-001	Revision: F	Sheet: 2 of 2
		PIPING SPECIFICATION FOR TOPSIDE						Material: SS316/316L

Valves (see notes)

Type	Size	CODE	Temp	Type	Size	CODE	Temp	Type	Size	CODE	Temp	Type	Size	CODE	Temp
Needle	3/4" - 1 1/2"	VAG-3000-1-S201	-100C to 200C	Ball	2" - 6"	VES-300-1-S210	-30C to 150C	Gate	2" - 6"	VGA-300-1-S201	-46C to 400C	Check	3/4" - 1 1/2"	VRE-800-1-S202	-100C to 400C
Ball	3/4" - 1 1/2"	VES-801-1-S201	-30C to 150C	Gate	3/4" - 1 1/2"	VGA-801-1-S201	-46C to 400C	Globe	2" - 6"	VGL-300-1-S201	-29C to 400C		2" - 6"	VRE-300-1-S211	0C to 150C



Branch (see notes)

RUN SIZE	0.5	TEE														
	0.75	RTEE	RTEE	TEE												
	1	RTEE	RTEE	RTEE	TEE											
	1.5	RTEE	RTEE	RTEE	RTEE	TEE										
	2	RTEE	RTEE	RTEE	RTEE	RTEE	TEE									
	3	RTEE	RTEE	RTEE	RTEE	RTEE	RTEE	TEE								
	4	RTEE	RTEE	RTEE	RTEE	RTEE	RTEE	RTEE	TEE							
6	RTEE	RTEE	RTEE	RTEE	RTEE	RTEE	RTEE	RTEE	TEE							
	0.5	0.75	1	1.5	2	3	4	6	BRANCH SIZE							

- WOL - Weldolet
- TEE - Tee
- RTEE - Red Tee
- HC - Half Coupling
- SOC - Sockolet

Notes

2	See Annex A for valves requirements and general selection criteria.
3	Bolts, nuts and gaskets (only RTJ gaskets) must be Zn-Ni coated according to Annex B.
91	Specific tools shall be used to assembly piping fittings, therefore is mandatory manufacturer assistance.
125	Materials shall follow the requirements of IOGP S-563- Material Data Sheets for Piping and Valve Components. Coating for bolts and nuts shall follow spec note number 3.

		OFFSHORE PRODUCTION FACILITIES				Doc: I-ET-3010.1M-1200-200- P4X-001	Revision: F	Sheet 1 of 2
		PIPING SPECIFICATION FOR TOPSIDE					Issued by: SRGE/ESUP	Code: ASME B31.3



Services (see notes): BG - Inert Gas; CHW - Chilled Water; DA - Open Drain; OL - Lubricating Oil; SA - Service Compressed Air (utility Air); SN - Start-up Nitrogen; W - Industrial water;	Material: Carbon Steel	Class: 150	Standard: R9B
---	----------------------------------	----------------------	-------------------------

Pressure Rating (see notes)

Temperature (°C)	0	38	50	70							
Max Pressure (barg)	19.6	19.6	19.2	18.6							

Pipes and Fittings (see notes)

Items		Code	Size	Wall	Class	Ends	Standard	Material
Pipes	Pipe	T-102	¾" - 1 ½"	S-160	-	PE	ASME B36.10	API 5L Gr B PSL 1 SML
			2" - 6"	XS		BE		API 5L Gr B PSL 1 (SML or WLD HFW or WLD SAW)
Fittings	45 Elbow GMC Type I	C70-02	¾" - 6"	-	-	GMC Type I	ASTM F1476/ISO 15837	ASTM A105
	90 Elbow GMC Type I	C71-02						
	Coupling GMC Type I	C72-02						
	Tee GMC Type I	C73-02						
	Cap GMC Type I	C74-02						
Gasket/Flanges	Blind	F-150-L2	¾" - 6"	According to pipe	Class 150	Raised Face	ASME B16.5	ASTM A105
	Flange GMC Type I	F-150-52						
Bolts & Nuts	Spiral-Wound	J-150-EH	¾" - 6"	-	Class 150	Raised Face	ASME B16.20	AISI 316/graphite
	Stud and Nuts	P-150-07	¾" - 1 ½"	-	-	-	ASME B1.1	A193 B7, Zn-Ni A194 Gr 2H, Zn-Ni

		OFFSHORE PRODUCTION FACILITIES				Doc: I-ET-3010.1M-1200-200-P4X-001	Revision: F	Sheet: 2 of 2
		PIPING SPECIFICATION FOR TOPSIDE						Material: Carbon Steel

Valves (see notes)

Type	Size	CODE	Temp	Type	Size	CODE	Temp	Type	Size	CODE	Temp	Type	Size	CODE	Temp
Needle	3/4" - 1 1/2"	VAG-3000-1-S201	-100C to 200C	Ball	2" - 6"	VES-150-1-C110	-29C to 150C	Gate	2" - 6"	VGA-150-1-C101	-29C to 400C	Check	3/4" - 1 1/2"	VRE-800-1-C102	-29C to 400C
Ball	3/4" - 1 1/2"	VES-803-1-C101	0C to 150C	Gate	3/4" - 1 1/2"	VGA-801-1-C101	-29C to 400C	Globe	2" - 6"	VGL-150-1-C101	-29C to 400C		2" - 6"	VRE-150-1-C111	0C to 150C



Branch (see notes)

RUN SIZE	0.5	TEE														
	0.75	RTEE	RTEE	TEE												
	1	RTEE	RTEE	RTEE	TEE											
	1.5	RTEE	RTEE	RTEE	RTEE	TEE										
	2	RTEE	RTEE	RTEE	RTEE	RTEE	TEE									
	3	RTEE	RTEE	RTEE	RTEE	RTEE	RTEE	TEE								
	4	RTEE	RTEE	RTEE	RTEE	RTEE	RTEE	RTEE	TEE							
6	RTEE	RTEE	RTEE	RTEE	RTEE	RTEE	RTEE	RTEE	TEE							
	0.5	0.75	1	1.5	2	3	4	6	BRANCH SIZE							

- WOL - Weldolet
- TEE - Tee
- RTEE - Red Tee
- HC - Half Coupling
- SOC - Sockolet

Notes

2	See Annex A for valves requirements and general selection criteria.
3	Bolts, nuts and gaskets (only RTJ gaskets) must be Zn-Ni coated according to Annex B.
91	Specific tools shall be used to assembly piping fittings, therefore is mandatory manufacturer assistance.
125	Materials shall follow the requirements of IOGP S-563- Material Data Sheets for Piping and Valve Components. Coating for bolts and nuts shall follow spec note number 3.

		OFFSHORE PRODUCTION FACILITIES				Doc: I-ET-3010.1M-1200-200- P4X-001	Revision: F	Sheet 1 of 2
		PIPING SPECIFICATION FOR TOPSIDE					Issued by: SRGE/ESUP	Code: ASME B31.3



Services (see notes): BG - Inert Gas; CHW - Chilled Water; DA - Open Drain; OL - Lubricating Oil; SA - Service Compressed Air (utility Air); SN - Start-up Nitrogen; W - Industrial water;					Material: Carbon Steel	Class: 300	Standard: R9C
---	--	--	--	--	---------------------------	---------------	------------------

Pressure Rating (see notes)

Temperature (°C)	0	70								
Max Pressure (barg)	40	40								

Pipes and Fittings (see notes)

Items		Code	Size	Wall	Class	Ends	Standard	Material
Pipes	Pipe	T-102	¾" - 1 ½"	S-160	-	PE	ASME B36.10	API 5L Gr B PSL 1 SML
			2" - 6"	XS		BE		API 5L Gr B PSL 1 (SML or WLD HFW or WLD SAW)
Fittings	45 Elbow GMC Type I	C70-02	¾" - 6"	-	-	GMC Type I	ASTM F1476/ISO 15837	ASTM A105
	90 Elbow GMC Type I	C71-02						
	Coupling GMC Type I	C72-02						
	Tee GMC Type I	C73-02						
	Cap GMC Type I	C74-02						
Blind & Gasket Flanges	Blind	F-300-L2	¾" - 6"	According to pipe	Class 300	Raised Face	ASME B16.5	ASTM A105
	Spiral-Wound	J-300-EH	¾" - 6"	-	Class 300	Raised Face	ASME B16.20	AISI 316/graphite
Bolts & Nuts	Stud and Nuts	P-300-07	¾" - 1 ½"	-	-	-	ASME B1.1	A193 B7, Zn-Ni
								A194 Gr 2H, Zn-Ni

		OFFSHORE PRODUCTION FACILITIES				Doc: I-ET-3010.1M-1200-200-P4X-001	Revision: F	Sheet: 2 of 2
		PIPING SPECIFICATION FOR TOPSIDE						Material: Carbon Steel

Valves (see notes)

Type	Size	CODE	Temp	Type	Size	CODE	Temp	Type	Size	CODE	Temp	Type	Size	CODE	Temp
Needle	3/4" - 1 1/2"	VAG-3000-1-S201	-100C to 200C	Ball	2" - 6"	VES-300-1-C110	-29C to 150C	Gate	2" - 6"	VGA-300-1-C101	-29C to 400C	Check	3/4" - 1 1/2"	VRE-800-1-C102	-29C to 400C
Ball	3/4" - 1 1/2"	VES-803-1-C101	0C to 150C	Gate	3/4" - 1 1/2"	VGA-801-1-C101	-29C to 400C	Globe	2" - 6"	VGL-300-1-C101	-29C to 400C		2" - 6"	VRE-300-1-C111	0C to 150C



Branch (see notes)

RUN SIZE	0.5	TEE														
	0.75	RTEE	RTEE	TEE												
	1	RTEE	RTEE	RTEE	TEE											
	1.5	RTEE	RTEE	RTEE	RTEE	TEE										
	2	RTEE	RTEE	RTEE	RTEE	RTEE	TEE									
	3	RTEE	RTEE	RTEE	RTEE	RTEE	RTEE	TEE								
	4	RTEE	RTEE	RTEE	RTEE	RTEE	RTEE	RTEE	TEE							
6	RTEE	RTEE	RTEE	RTEE	RTEE	RTEE	RTEE	RTEE	TEE							
	0.5	0.75	1	1.5	2	3	4	6	BRANCH SIZE							

- WOL - Weldolet
- TEE - Tee
- RTEE - Red Tee
- HC - Half Coupling
- SOC - Sockolet

Notes



2	See Annex A for valves requirements and general selection criteria.
3	Bolts, nuts and gaskets (only RTJ gaskets) must be Zn-Ni coated according to Annex B.
91	Specific tools shall be used to assembly piping fittings, therefore is mandatory manufacturer assistance.
125	Materials shall follow the requirements of IOGP S-563- Material Data Sheets for Piping and Valve Components. Coating for bolts and nuts shall follow spec note number 3.

		OFFSHORE PRODUCTION FACILITIES				Doc: I-ET-3010.1M-1200-200- P4X-001	Revision: F	Sheet 1 of 2
		PIPING SPECIFICATION FOR TOPSIDE						Issued by: SRGE/ESUP

Services (see notes): BG - Inert Gas; CNI - Corrosive Chemical Injection (Except Sodium Hypochlorite); DW - Distilled Water; H - Hydraulic Fluid; IA - Instrumentation Air; IN - Instrumentation Nitrogen; PW - Potable Water; PWH - Hot Fresh Water;	Material: SS316/316L	Class: 150	Standard: S3B
---	-------------------------	---------------	------------------

Pressure Rating (see notes)										
Temperature (°C)	0	38	50	60						
Max Pressure (barg)	19.0	19.0	18.4	17.9						

Pipes and Fittings (see notes)								
	Items	Code	Size	Wall	Class	Ends	Standard	Material
Pipes	Pipe	T-322	½" - 1 ½"	S-40S	-	PE	ASME B36.19	ASTM A312 TP 316/316L SML
	Fittings	45 Elbow MAF Type I	C40-26	½" - 2"	-	-	MAF	ASTM F1387
90 Elbow MAF Type I		C41-26						
Coupling MAF Type I		C42-26						
Tee MAF Type I		C43-26						
Union MAF Type I		C44-26						
Cap MAF Type I	C45-26							
Gaskets & Flanges	Blind	F-150-LF	½" - 2"	According to pipe	Class 150	Raised Face	ASME B16.5	ASTM A182 Gr F316
	Flange MAF Type I	F-150-ZF					ASTM F1387	
Bolts & Nuts	Spiral-Wound	J-150-EH	½" - 2"	-	Class 150	Raised Face	ASME B16.20	AISI 316/graphite
	Stud and Nuts	P-150-07	½" - 1"	-	-	-	ASME B1.1	A193 B7, Zn-Ni A194 Gr 2H, Zn-Ni

		OFFSHORE PRODUCTION FACILITIES				Doc: I-ET-3010.1M-1200-200-P4X-001	Revision: F	Sheet: 2 of 2
		PIPING SPECIFICATION FOR TOPSIDE						Material: SS316/316L

Valves (see notes)

Type	Size	CODE	Temp	Type	Size	CODE	Temp	Type	Size	CODE	Temp	Type	Size	CODE	Temp
Needle	½" - 1 ½"	VAG-3000-1-S201	-100C to 200C	Ball	2"	VES-150-1-S210	-30C to 150C	Gate	2"	VGA-150-1-S201	-46C to 400C	Check	½" - 1 ½"	VRE-800-1-S202	-100C to 400C
Ball	½" - 1 ½"	VES-801-1-S201	-30C to 150C	Gate	½" - 1 ½"	VGA-801-1-S201	-46C to 400C	Globe	2"	VGL-150-1-S201	-29C to 400C		2"	VRE-150-1-S211	0C to 150C



Branch (see notes)

RUN SIZE	0.5	Tee MAF Type I				
	0.75	RTEE	Tee MAF Type I			
	1	RTEE	RTEE	Tee MAF Type I		
	1.5	RTEE	RTEE	RTEE	Tee MAF Type I	
	2	RTEE	RTEE	RTEE	RTEE	Tee MAF Type I
	0.5	0.75	1	1.5	2	
BRANCH SIZE						

- WOL - Weldolet
- TEE - Tee
- RTEE - Red Tee
- HC - Half Coupling
- SOC - Sockolet

Notes



2	See Annex A for valves requirements and general selection criteria.
3	Bolts, nuts and gaskets (only RTJ gaskets) must be Zn-Ni coated according to Annex B.
91	Specific tools shall be used to assembly piping fittings, therefore is mandatory manufacturer assistance.
96	Fittings according to ASTM F1387 - Standard Specification for Performance of Piping and Tubing Mechanically Attached Fittings.
97	Epoxy resins or similar shall be applied in the gap between pipings and fittings, to avoid crevice corrosion.
125	Materials shall follow the requirements of IOGP S-563- Material Data Sheets for Piping and Valve Components. Coating for bolts and nuts shall follow spec note number 3.

		OFFSHORE PRODUCTION FACILITIES				Doc: I-ET-3010.1M-1200-200- P4X-001	Revision: F	Sheet 1 of 2
		PIPING SPECIFICATION FOR TOPSIDE					Issued by: SRGE/ESUP	Code: ASME B31.3

Services (see notes): BG - Inert Gas; CNI - Corrosive Chemical Injection (Except Sodium Hypochlorite); DW - Distilled Water; H - Hydraulic Fluid; IA - Instrumentation Air; IN - Instrumentation Nitrogen; PW - Potable Water; PWH - Hot Fresh Water;	Material: SS316/316L	Class: 300	Standard: S3C
---	-------------------------	---------------	------------------

Pressure Rating (see notes)										
Temperature (°C)	0	38	50	60						
Max Pressure (barg)	49.6	49.6	48.1	46.9						

Pipes and Fittings (see notes)								
	Items	Code	Size	Wall	Class	Ends	Standard	Material
Pipes	Pipe	T-322	½" - 1 ½"	S-40S	-	PE	ASME B36.19	ASTM A312 TP 316/316L SML
	Fittings	45 Elbow MAF Type I	C40-26	½" - 2"	-	-	MAF	ASTM F1387
90 Elbow MAF Type I		C41-26						
Coupling MAF Type I		C42-26						
Tee MAF Type I		C43-26						
Union MAF Type I		C44-26						
Cap MAF Type I	C45-26							
Gaskets & Flanges	Blind	F-300-LF	½" - 2"	According to pipe	Class 300	Raised Face	ASME B16.5	ASTM A182 Gr F316
	Flange MAF Type I	F-300-ZF					ASTM F1387	
Bolts & Nuts	Spiral-Wound	J-300-EH	½" - 2"	-	Class 300	Raised Face	ASME B16.20	AISI 316/graphite
	Stud and Nuts	P-300-07	½" - 1"	-	-	-	ASME B1.1	A193 B7, Zn-Ni A194 Gr 2H, Zn-Ni

		OFFSHORE PRODUCTION FACILITIES				Doc: I-ET-3010.1M-1200-200-P4X-001	Revision: F	Sheet: 2 of 2
		PIPING SPECIFICATION FOR TOPSIDE						Material: SS316/316L

Valves (see notes)

Type	Size	CODE	Temp	Type	Size	CODE	Temp	Type	Size	CODE	Temp	Type	Size	CODE	Temp
Needle	½" - 1 ½"	VAG-3000-1-S201	-100C to 200C	Ball	2"	VES-300-1-S210	-30C to 150C	Gate	2"	VGA-300-1-S201	-46C to 400C	Check	½" - 1 ½"	VRE-800-1-S202	-100C to 400C
Ball	½" - 1 ½"	VES-801-1-S201	-30C to 150C	Gate	½" - 1 ½"	VGA-801-1-S201	-46C to 400C	Globe	2"	VGL-300-1-S201	-29C to 400C		2"	VRE-300-1-S211	0C to 150C



Branch (see notes)

RUN SIZE	0.5	Tee MAF Type I				
	0.75	RTEE	Tee MAF Type I			
	1	RTEE	RTEE	Tee MAF Type I		
	1.5	RTEE	RTEE	RTEE	Tee MAF Type I	
	2	RTEE	RTEE	RTEE	RTEE	Tee MAF Type I
	0.5	0.75	1	1.5	2	
BRANCH SIZE						

- WOL - Weldolet
- TEE - Tee
- RTEE - Red Tee
- HC - Half Coupling
- SOC - Sockolet

Notes

2	See Annex A for valves requirements and general selection criteria.
3	Bolts, nuts and gaskets (only RTJ gaskets) must be Zn-Ni coated according to Annex B.
91	Specific tools shall be used to assembly piping fittings, therefore is mandatory manufacturer assistance.
96	Fittings according to ASTM F1387 - Standard Specification for Performance of Piping and Tubing Mechanically Attached Fittings.
97	Epoxy resins or similar shall be applied in the gap between pipings and fittings, to avoid crevice corrosion.
125	Materials shall follow the requirements of IOGP S-563- Material Data Sheets for Piping and Valve Components. Coating for bolts and nuts shall follow spec note number 3.

		OFFSHORE PRODUCTION FACILITIES				Doc: I-ET-3010.1M-1200-200- P4X-001	Revision: F	Sheet 1 of 2
		PIPING SPECIFICATION FOR TOPSIDE					Issued by: SRGE/ESUP	Code: ASME B31.3



Services (see notes): FW - Fire Water (Sea Water);	Material: Copper-Nickel	Class: 20 bar	Standard: S7
---	----------------------------	------------------	-----------------

Pressure Rating (see notes)

Temperature (°C)	0	38	50	75							
Max Pressure (barg)	19.6	19.6	19.2	18.4							

Pipes and Fittings (see notes)

Items		Code	Size	Wall	Class	Ends	Standard	Material
Pipes	Pipe	T-202	½" - ¾"	2.0mm	-	PE	EEMUA 234	Cu-Ni 90/10 (UNS C70620) SML
			1" - 2"	2.5mm				
Fittings	45 Elbow MAF Type I	C40-34	½" - 2"	-	-	MAF	ASTM F1387	Cu-Ni 70/30
	90 Elbow MAF Type I	C41-34						
	Coupling MAF Type I	C42-34						
	Tee MAF Type I	C43-34						
	Union MAF Type I	C44-34						
Cap MAF Type I	C45-34							
Bolts & Gasket/Flanges	Blind	F-20-LN	½" - 2"	According to pipe	20 bar	Raised Face	ASME B16.5	Cu-Ni 70/30
	Flange MAF Type I	F-20-ZN					ASTM F1387	
Bolts & Gasket/Flanges	Flat type	J-150-PA	½" - 2"	-	Class 150	Raised Face	ASME B16.21	Aramid/NBR
	Stud and Nuts	P-150-07	½" - 1"	-	-	-	ASME B1.1	A193 B7, Zn-Ni A194 Gr 2H, Zn-Ni

		OFFSHORE PRODUCTION FACILITIES				Doc: I-ET-3010.1M-1200-200-P4X-001	Revision: F	Sheet: 2 of 2
		PIPING SPECIFICATION FOR TOPSIDE						Material: Copper-Nickel

Valves (see notes)

Type	Size	CODE	Temp	Type	Size	CODE	Temp	Type	Size	CODE	Temp	Type	Size	CODE	Temp
Gate	1/2" - 2"	VGA-200-1-U101	-29C to 75C	Globe	2"	VGL-150-1-U301	-46C to 75C	Check	1/2" - 1 1/2"	VRE-200-1-U122	0C to 75C	Check	2"	VRE-150-1-U311	0C to 75C
	2"	VGA-150-1-U301	-46C to 75C												

Branch (see notes)



RUN SIZE	0.5	Tee MAF Type I				
	0.75	RTEE	Tee MAF Type I			
	1	RTEE	RTEE	Tee MAF Type I		
	1.5	RTEE	RTEE	RTEE	Tee MAF Type I	
	2	RTEE	RTEE	RTEE	RTEE	Tee MAF Type I
		0.5	0.75	1	1.5	2

BRANCH SIZE

- WOL - Weldolet
- TEE - Tee
- RTEE - Red Tee
- HC - Half Coupling
- SOC - Sockolet

Notes



2	See Annex A for valves requirements and general selection criteria.
3	Bolts, nuts and gaskets (only RTJ gaskets) must be Zn-Ni coated according to Annex B.
85	The thicknesses listed in this spec are minimum and shall be confirmed by fittings supplier in order to guarantee the correct assembly.
91	Specific tools shall be used to assembly piping fittings, therefore is mandatory manufacturer assistance.
96	Fittings according to ASTM F1387 - Standard Specification for Performance of Piping and Tubing Mechanically Attached Fittings.
97	Epoxy resins or similar shall be applied in the gap between pipings and fittings, to avoid crevice corrosion.
125	Materials shall follow the requirements of IOGP S-563- Material Data Sheets for Piping and Valve Components. Coating for bolts and nuts shall follow spec note number 3.

		OFFSHORE PRODUCTION FACILITIES				Doc: I-ET-3010.1M-1200-200- P4X-001	Revision: F	Sheet 1 of 2
		PIPING SPECIFICATION FOR TOPSIDE					Issued by: SRGE/ESUP	Code: ASME B31.3

Services (see notes): BG - Inert Gas; CHW - Chilled Water; CI - Chemical Injection (non-corrosive); DA - Open Drain; OL - Lubricating Oil; S - Steam; SA - Service Compressed Air (utility Air); SC - Steam Condensate; SN - Start-up Nitrogen; W - Industrial water;	Material: Carbon Steel	Class: 150	Standard: S9B
--	----------------------------------	----------------------	-------------------------

Pressure Rating (see notes)										
Temperature (°C)	0	38	50	100						
Max Pressure (barg)	19.6	19.6	19.2	17.7						

Pipes and Fittings (see notes)									
Items		Code	Size	Wall	Class	Ends	Standard	Material	
Pipes	Pipe	T-102	½" - ¾"	S-160	-	PE	ASME B36.10	API 5L Gr B PSL 1 SML	
			1" - 1 ½"	XS		BE		API 5L Gr B PSL 1 (SML or WLD HFW or WLD SAW)	
			2"						
Fittings	45 Elbow MAF Type I	C40-02	½" - 2"	-	-	MAF	ASTM F1387	ASTM A105	
	90 Elbow MAF Type I	C41-02							
	Coupling MAF Type I	C42-02							
	Tee MAF Type I	C43-02							
	Union MAF Type I	C44-02							
	Cap MAF Type I	C45-02							
Gasket	Swage Conc Nipple	N-C602	¾" - 2"	According to pipe	-	MAF	ASTM F1387	ASTM A105	
	Blind	F-150-L2	½" - 2"	According to pipe	Class 150	Raised Face	ASME B16.5	ASTM A105	
	Flange MAF Type I	F-150-Z2					ASTM F1387		
Bolts & Nuts	Spiral-Wound	J-150-EH	½" - 2"	-	Class 150	Raised Face	ASME B16.20	AISI 316/graphite	
	Stud and Nuts	P-150-07	½" - 1"	-	-	-	ASME B1.1	A193 B7, Zn-Ni A194 Gr 2H, Zn-Ni	

		OFFSHORE PRODUCTION FACILITIES		Doc: I-ET-3010.1M-1200-200-P4X-001	Revision: F	Sheet: 2 of 2
		PIPING SPECIFICATION FOR TOPSIDE				Material: Carbon Steel

Valves (see notes)

Type	Size	CODE	Temp	Type	Size	CODE	Temp	Type	Size	CODE	Temp	Type	Size	CODE	Temp
Needle	½" - 1 ½"	VAG-3000-1-S201	-100C to 200C	Ball	2"	VES-150-1-C110	-29C to 150C	Gate	½" - 1 ½"	VGA-801-1-C102	-29C to 400C	Globe	2"	VGL-150-2-C102	-29C to 400C
Ball	½" - 1 ½"	VES-803-1-C101	0C to 150C			VES-150-1-C160	0C to 210C			VGA-150-1-C101				VGA-150-2-C102	
		VES-803-1-C105	0C to 210C			VES-150-2-C110	-29C to 150C	VGL-150-1-C101	-29C to 400C						
		VES-803-2-C101	-29C to 150C			VES-150-2-C160	0C to 210C	Globe	2"	VGL-150-1-C101	-29C to 400C				
		VES-803-2-C105	0C to 210C	VGA-801-1-C101	-29C to 400C										
				Gate	½" - 1 ½"	VGA-801-1-C101	-29C to 400C								

Branch (see notes)



RUN SIZE	0.5	Tee MAF Type I				
	0.75	RTEE	Tee MAF Type I			
	1	RTEE	RTEE	Tee MAF Type I		
	1.5	RTEE	RTEE	RTEE	Tee MAF Type I	
2	RTEE	RTEE	RTEE	RTEE	Tee MAF Type I	
	0.5	0.75	1	1.5	2	

BRANCH SIZE

- WOL - Weldolet
- TEE - Tee
- RTEE - Red Tee
- HC - Half Coupling
- SOC - Sockolet

Notes



2	See Annex A for valves requirements and general selection criteria.
3	Bolts, nuts and gaskets (only RTJ gaskets) must be Zn-Ni coated according to Annex B.
91	Specific tools shall be used to assembly piping fittings, therefore is mandatory manufacturer assistance.
96	Fittings accordig to ASTM F1387 - Standard Specification for Performance of Piping and Tubing Mechanically Attached Fittings.
97	Epoxy resins or similar shall be applied in the gap betwen pipings and fittings, to avoid crevice corrosion.
125	Materials shall follow the requirements of IOGP S-563- Material Data Sheets for Piping and Valve Components. Coating for bolts and nuts shall follow spec note number 3.

		OFFSHORE PRODUCTION FACILITIES				Doc: I-ET-3010.1M-1200-200- P4X-001	Revision: F	Sheet 1 of 2
		PIPING SPECIFICATION FOR TOPSIDE					Issued by: SRGE/ESUP	Code: ASME B31.3

Services (see notes): BG - Inert Gas; CHW - Chilled Water; CI - Chemical Injection (non-corrosive); DA - Open Drain; OL - Lubricating Oil; S - Steam; SA - Service Compressed Air (utility Air); SC - Steam Condensate; SN - Start-up Nitrogen; W - Industrial water;	Material: Carbon Steel	Class: 300	Standard: S9C
--	----------------------------------	----------------------	-------------------------

Pressure Rating (see notes)										
Temperature (°C)	0	38	50	100						
Max Pressure (barg)	51.1	51.1	50.1	46.6						

Pipes and Fittings (see notes)											
Items	Code	Size	Wall	Class	Ends	Standard	Material				
Pipes	Pipe	T-102	1/2" - 3/4"	S-160	-	PE	ASME B36.10	API 5L Gr B PSL 1 SML			
			1" - 1 1/2"	XS				-	BE	API 5L Gr B PSL 1 (SML or WLD HFW or WLD SAW)	
			2"								
Fittings	45 Elbow MAF Type I	C40-02	1/2" - 2"	-	MAF	ASTM F1387	ASTM A105				
	90 Elbow MAF Type I	C41-02									
	Coupling MAF Type I	C42-02									
	Tee MAF Type I	C43-02									
	Union MAF Type I	C44-02									
Cap MAF Type I	C45-02										
Gasket	Swage Conc Nipple	N-C602	3/4" - 2"	According to pipe	-	MAF	ASTM F1387	ASTM A105			
	Blind	F-300-L2	1/2" - 2"	According to pipe	Class 300	Raised Face	ASME B16.5	ASTM A105			
Flange MAF Type I	F-300-Z2	ASTM F1387									
Bolts & Nuts	Spiral-Wound	J-300-EH	1/2" - 2"	-	Class 300	Raised Face	ASME B16.20	AISI 316/graphite			
	Stud and Nuts	P-300-07	1/2" - 1"	-	-	-	ASME B1.1	A193 B7, Zn-Ni A194 Gr 2H, Zn-Ni			

		OFFSHORE PRODUCTION FACILITIES		Doc: I-ET-3010.1M-1200-200-P4X-001	Revision: F	Sheet: 2 of 2
		PIPING SPECIFICATION FOR TOPSIDE				Material: Carbon Steel

Valves (see notes)

Type	Size	CODE	Temp	Type	Size	CODE	Temp	Type	Size	CODE	Temp	Type	Size	CODE	Temp
Needle	½" - 1 ½"	VAG-3000-1-S201	-100C to 200C	Ball	2"	VES-300-1-C110	-29C to 150C	Gate	½" - 1 ½"	VGA-801-1-C102	-29C to 400C	Globe	2"	VGL-300-2-C102	-29C to 400C
Ball	½" - 1 ½"	VES-803-1-C101	0C to 150C			VES-300-1-C160	0C to 210C			VGA-300-1-C101				VRE-800-1-C103	-29C to 400C
		VES-803-1-C105	0C to 210C			VES-300-2-C110	-29C to 150C	VGA-300-2-C102	VRE-300-1-C111	0C to 150C					
		VES-803-2-C101	-29C to 150C			VES-300-2-C160	0C to 210C	Globe		2"	VGL-300-1-C101	-29C to 400C	VRE-300-2-C113	-29C to 400C	
		VES-803-2-C105	0C to 210C	Gate	½" - 1 ½"	VGA-801-1-C101	-29C to 400C								



Branch (see notes)

RUN SIZE	0.5	Tee MAF Type I				
	0.75	RTEE	Tee MAF Type I			
	1	RTEE	RTEE	Tee MAF Type I		
	1.5	RTEE	RTEE	RTEE	Tee MAF Type I	
2	RTEE	RTEE	RTEE	RTEE	Tee MAF Type I	
	0.5	0.75	1	1.5	2	
	BRANCH SIZE					

- WOL - Weldolet
- TEE - Tee
- RTEE - Red Tee
- HC - Half Coupling
- SOC - Sockolet

Notes

2	See Annex A for valves requirements and general selection criteria.
3	Bolts, nuts and gaskets (only RTJ gaskets) must be Zn-Ni coated according to Annex B.
91	Specific tools shall be used to assembly piping fittings, therefore is mandatory manufacturer assistance.
96	Fittings accordig to ASTM F1387 - Standard Specification for Performance of Piping and Tubing Mechanically Attached Fittings.
97	Epoxy resins or similar shall be applied in the gap betw een pipings and fittings, to avoid crevice corrosion.
125	Materials shall follow the requirements of IOGP S-563- Material Data Sheets for Piping and Valve Components. Coating for bolts and nuts shall follow spec note number 3.

		OFFSHORE PRODUCTION FACILITIES				Doc: I-ET-3010.1M-1200-200-P4X-001	Revision: F	Sheet 1 of 2
		PIPING SPECIFICATION FOR TOPSIDE				Issued by: SRGE/ESUP	Code: ASME B31.3	Corr. Allow.: -



Services (see notes): CI - Chemical Injection (non-corrosive); CNI - Corrosive Chemical Injection (Except Sodium Hypochlorite);	Material: Tubing SS316/316L	Class: -	Standard: T3
---	---	--------------------	------------------------

Pressure Rating (see notes)

DN	0 to 60°C								DN	0 to 60°C							DN	0 to 60°C
1/4"	413								3/4"	399								
3/8"	413								1"	324								
1/2"	413								1 1/4"	337								
5/8"	413								1 1/2"	337								

Pipes and Fittings (see notes)

Items	Code	Size	Wall	Class	Ends	Standard	Material	
Pipes	Pipe	T-319	1/4"	0.049"	-	PE	-	ASTM A269 Type 316/316L, hardness <= 80 HRB SML
			3/8"	0.065"				
			1/2"	0.083"				
			5/8"	0.095"				
			3/4"	0.109"				
			1"	0.120"				
			1 1/4"	0.156"				
1 1/2"	0.188"							
Fittings	Compression Fitting	C60-40	1/4" - 1 1/2"	-	6000	OD x OD OD x THD OD x SW	according to manufacturer Compression fitting with double ferrule, body AISI 316, ferrules and nuts in AISI 316.	

		OFFSHORE PRODUCTION FACILITIES				Doc: I-ET-3010.1M-1200-200-P4X-001	Revision: F	Sheet: 2 of 2
		PIPING SPECIFICATION FOR TOPSIDE					Material: Tubing SS316/316L	Class: -

Valves (see notes)

Type	Size	CODE	Temp	Type	Size	CODE	Temp	Type	Size	CODE	Temp	Type	Size	CODE	Temp
Instrumentation Needle	1/4"	VAGI-6000-1-S201	0C to 200C	Instrumentation Ball	1/4"	VESI-6000-1-S201	0C to 200C	Instrumentation Check	1/4"	VREI-6000-1-S201	0C to 90C	Instrumentation Check	1/4"	VREI-6000-1-S202	0C to 90C
		VAGI-6000-1-S202				VESI-6000-1-S202									



Branch (see notes)

RUN SIZE	0.25	TEE	0.375	RTEE	TEE	0.5	RTEE	RTEE	TEE	0.625	RTEE	RTEE	RTEE	TEE	0.75	RTEE	RTEE	RTEE	RTEE	TEE	1	RTEE	RTEE	RTEE	RTEE	RTEE	TEE	1.25	RTEE	RTEE	RTEE	RTEE	RTEE	RTEE	TEE	1.5	RTEE	RTEE	RTEE	RTEE	RTEE	RTEE	RTEE	TEE
	BRANCH SIZE																																											

- WOL - Weldolet
- TEE - Tee
- RTEE - Red Tee
- HC - Half Coupling
- SOC - Sockolet

Notes

2	See Annex A for valves requirements and general selection criteria.
72	Tubing rods shall be provided with a standard 6-meter length. Coiled tubings are not acceptable
76	Tube fittings shall have the manufacturer's name and the traceability code indelibly engraved. Ferrules may have only the manufacturer's name engraved.
78	Tube fittings shall be double ferrule type.
81	The tubing shall be prepared (cut, burred, and bent) only with the tools recommended by the OD fittings manufacturer.
84	The tube material specification EN 1.4435 may be used instead of ASTM A269 316L
88	The minimum Molybdenum content shall be 2,5% for tubing material.
89	The maximum work pressure for fittings shall be above the maximum work pressure of the tubing for all operation conditions.
93	Seal or fillet welds are not allowed in OD fittings and valves assembly.
95	Proper tools shall be used to assemble the OD fittings (feeler gauge, wrenches etc.) in accordance with the fittings' manufacture instructions. Special attention shall be given for assemblies with OD 1" and larger where preswage must be done.
124	The maximum pressure of a system with several diameters is limited by the lowest pressure according to the spec pressure table.

		OFFSHORE PRODUCTION FACILITIES						Doc: I-ET-3010.1M-1200-200- P4X-001	Revision: F	Sheet 1 of 2
		PIPING SPECIFICATION FOR TOPSIDE						Issued by: SRGE/ESUP	Code: ASME B31.3	Corr. Allow.: -



Services (see notes): CI - Chemical Injection (non-corrosive); CNI - Corrosive Chemical Injection (Except Sodium Hypochlorite);						Material: Tubing SuperDuplex	Class: -	Standard: T12
--	--	--	--	--	--	------------------------------------	-------------	------------------

Pressure Rating (see notes)

DN	0 to 90°C								DN	0 to 90°C							DN	0 to 90°C
1/2"	632								5/8"	648							3/4"	616

Pipes and Fittings (see notes)

Items		Code	Size	Wall	Class	Ends	Standard	Material
Pipes	Pipe	T-324	1/2"	0.065"	-	PE	-	ASTM A789 (UNS S32760) SML
			5/8"	0.083"				
			3/4"	0.095"				
Fittings	Compression Fitting	C60-47	1/2"	-	10000	OD x THD	according to manufacturer	Compression fitting with double ferrule, body/nut/ferrule SuperDuplex UNS 32760
			OD x SW					
			OD x OD					
			OD x THD					
			OD x SW					
			OD x OD					
			OD x THD					
OD x SW								
OD x OD								

		OFFSHORE PRODUCTION FACILITIES				Doc: I-ET-3010.1M-1200-200-P4X-001	Revision: F	Sheet: 2 of 2
		PIPING SPECIFICATION FOR TOPSIDE					Material: Tubing SuperDuplex	Class: -

Valves (see notes)

Type	Size	CODE	Temp	Type	Size	CODE	Temp	Type	Size	CODE	Temp	Type	Size	CODE	Temp
Instrumentation Needle	½"	VAGI-10000-1-D301	0C to 200C	Instrumentation Ball	½"	VESI-10000-1-D301	0C to 200C	Instrumentation Check	½"	VREI-10000-1-D301	0C to 90C	Instrumentation Check	½"	VREI-10000-1-D302	0C to 90C
		VAGI-10000-1-D302				VESI-10000-1-D302				VREI-10000-1-D302					

Branch (see notes)

RUN SIZE	0.5	TEE	
	0.625	RTEE TEE	
	0.75	RTEE RTEE TEE	
	0.5	0.625	0.75
	BRANCH SIZE		

- WOL - Weldolet
- TEE - Tee
- RTEE - Red Tee
- HC - Half Coupling
- SOC - Sockolet

Notes

2	See Annex A for valves requirements and general selection criteria.
72	Tubing rods shall be provided with a standard 6-meter length. Coiled tubings are not acceptable
76	Tube fittings shall have the manufacturer's name and the traceability code indelibly engraved. Ferrules may have only the manufacturer's name engraved.
78	Tube fittings shall be double ferrule type.
81	The tubing shall be prepared (cut, burred, and bent) only with the tools recommended by the OD fittings manufacturer.
89	The maximum work pressure for fittings shall be above the maximum work pressure of the tubing for all operation conditions.
93	Seal or fillet welds are not allowed in OD fittings and valves assembly.
95	Proper tools shall be used to assemble the OD fittings (feeler gauge, wrenches etc.) in accordance with the fittings' manufacture instructions. Special attention shall be given for assemblies with OD 1" and larger where preswage must be done.
124	The maximum pressure of a system with several diameters is limited by the lowest pressure according to the spec pressure table.

ANNEX A – VALVES (Mandatory)

INDEX

A.1.SCOPE	5
A.2.NORMATIVE REFERENCES	5
A.3.TERMS AND DEFINITIONS	7
A.4.SYMBOLS AND ABBREVIATED TERMS	9
A.5.VALVE SELECTION GUIDE	10
A.5.1. INTRODUCTION.....	10
A.5.2. VALVE SPECIFICATION LEVEL (VSL) - CLASSIFICATION	11
A.5.3. VALVE SPECIFICATION LEVEL (VSL) - REQUIREMENTS	12
A.5.4. VALVE FEATURES AND TYPICAL APLICATIONS.....	13
A.6.GENERAL DESIGN REQUIREMENTS	15
A.6.1. VALVE.....	15
A.6.2. ACTUATOR.....	22
A.7.SPECIFIC DESIGN REQUIREMENTS.....	23
A.7.1. BALL VALVE	23
A.7.2. GATE VALVE	39
A.7.3. CHECK VALVE	43
A.7.4. GLOBE VALVE	46
A.7.5. BUTTERFLY VALVE.....	47
A.7.6. NON-METALLIC VALVE.....	51
A.8.MATERIALS & FABRICATION.....	53
A.8.1. REQUIREMENTS FOR CASTING OF DUPLEX & SUPERDUPLEX.....	53
A.8.2. COATINGS.....	58
A.8.3. ALTERNATIVE MATERIALS	61
A.9.INSPECTION & TESTING	62
A.9.1. INSPECTION REQUIREMENTS	62
A.9.2. DESIGN VALIDATION	64
A.9.3. FACTORY ACCEPTANCE TEST (FAT) REQUIREMENTS.....	65
A.10. HANDLING, STORING & SHIPPING.....	70
A.11. DOCUMENTATION.....	71
A.11.1. DOCUMENTATION FORMATS & QUALITY.....	71
A.11.2. DATA BOOK	71
A.11.3. USER MANUAL	72
A.11.4. DOCUMENTATION OF PRESERVATION, PROTECTION AND PACKING	72
A.11.5. VALVE CODE	72
A.12. VALVE DATASHEET - VDS	80

FIGURES

FIGURE A.1 – EXAMPLE OF USE OF DRAIN AND VENT PLUG	15
FIGURE A.2 – EXAMPLE OF NAMEPLATES WITH INDICATION OF SEAT CONFIGURATION	21
FIGURE A.3 - LOCATION OF DRAIN AND VENT PORTS	24
FIGURE A.4 – BALL TYPE	24
FIGURE A.5 – SPE/SR SEAT ASSEMBLY MECHANISM (ILLUSTRATION ON A SOFT BALL VALVE)	26
FIGURE A.6 – DPE SEAT ASSEMBLY MECHANISM (ILLUSTRATION ON A SOFT BALL VALVE)	26
FIGURE A.7 – DBB FEATURE (REF.: DOUBLE BLOCK AND BLEED - TYPE B OF API 6D)	27
FIGURE A.8 – DIB-1 FEATURE (REF.: DOUBLE ISOLATION AND BLEED - TYPE B OF API 6D).....	27
FIGURE A.9 – DIB-2 FEATURE (REF.: DOUBLE ISOLATION AND BLEED - TYPE B OF API 6D).....	28
FIGURE A.10 – ILLUSTRATION OF TYPICAL CATEGORY B (TRIPLE OFFSET) SEAT CONFIGURATIONS	49

TABLES

TABLE A.1 – CLASSIFICATION OF ACCUMULATED ENERGY AND HIGH DEMAND VALVES	12
TABLE A.2 – VALVE SPECIFICATION LEVEL (VSL) CLASSIFICATION	12
TABLE A.3 – VALVE SPECIFICATION LEVEL (VSL) REQUIREMENTS	13
TABLE A.4 - VALVE FEATURES AND TYPICAL APPLICATIONS	14
TABLE A.5 – MATERIAL CLASSES	16
TABLE A.6 – BODY MATERIAL, ACCORDING TO MATERIAL CLASS	16
TABLE A.7 – PROCESS FABRICATION FOR BODY MATERIALS ACCORDING TO VSL	17
TABLE A.8 – TIGHTNESS CLASS FOR STEM SEALS - FUGITIVE EMISSIONS (REF.: ISO 15848 PART 1).....	18
TABLE A.9 – TIGHTNESS CLASS FOR BODY SEALS - FUGITIVE EMISSIONS (REF.: ISO 15848 PART 1).....	18
TABLE A.10 – TIGHTNESS CLASS FOR STEM (OR SHAFT) SEALS WITH METHANE - FUGITIVE EMISSIONS (REF.: ISO 15848 PART 1).....	19
TABLE A.11 – LEAKAGE FROM BODY SEALS WITH METHANE - FUGITIVE EMISSIONS (REF.: ISO 15848 PART 1).....	19
TABLE A.12 – ENDURANCE CLASS ACCORDING VSL CLASSIFICATION	19
TABLE A.13 – TEMPERATURE CLASS OF FUGITIVE EMISSIONS (REF.: ISO 15848 PART 1)	19
TABLE A.14 – SIL LEVELS	19
TABLE A.15 - STUDS, BOLTS AND NUTS MATERIAL SPECIFICATION	20
TABLE A.16 – ACTUATORS TYPE	22
TABLE A.17 – DESIGN STANDARDS FOR BALL VALVES	25
TABLE A.18 – MOUNTING TYPE FOR BALL VALVES	25
TABLE A.19 – ISOLATION VALVE CONFIGURATION FOR BALL VALVES	28
TABLE A.20 – NON-METALLIC MATERIALS FOR SEAT INSERT SEAL DESIGN	28
TABLE A.21 – SEAL GROUPS MATERIALS	29
TABLE A.22 – INDICATION OF GROUPS OF SEALS ACCORDING FLUID CLASS AND TEMPERATURE RANGE	30
TABLE A.23 – SEALS GROUP CLASSIFICATION INTO VALVE CODE	31
TABLE A.24 – NIPPLE CLASSIFICATION INTO VALVE CODE	32
TABLE A.25 – TYPICAL CONFIGURATIONS FOR BALL VALVES UP TO NPS 1 1/2 (“FORGED” VALVES).....	32
TABLE A.26 – TYPICAL CONFIGURATIONS FOR BALL VALVES NPS 2 AND ABOVE	33
TABLE A.27 – TYPICAL CONFIGURATIONS FOR RISING STEM BALL VALVES	33
TABLE A.28 – TYPICAL CONFIGURATIONS FOR DOUBLE BALL VALVES.....	33
TABLE A.29 - STEM MATERIALS ACCORDING MATERIAL CLASS & PRESSURE CLASS OF THE VALVE.....	34
TABLE A.30 – SPECIFICATION OF METALLIC COATING (PARTIAL CLAD) FOR BALL VALVES	35
TABLE A.31 – SPECIFICATION OF HARD COATING ON SEATS / BALL ON SOFT BALL VALVES	36
TABLE A.32 – SPECIFICATION OF HARD COATING ON SEATS / BALL ON METAL TO METAL BALL VALVES	36
TABLE A.33 – TYPICAL CONFIGURATIONS FOR SOFT SEATED BALL VALVES ACCORDING MATERIAL CLASS	37
TABLE A.34 – TYPICAL CONFIGURATIONS FOR METAL TO METAL SEATED BALL VALVES ACCORDING MATERIAL CLASS	39

TABLE A.35 – DESIGN STANDARDS FOR GATE VALVES	41
TABLE A.36 – TRIM MATERIAL CONFIGURATION FOR SOLID WEDGE GATE VALVES	41
TABLE A.37 – OBTURATOR TYPE FOR GATE VALVES	42
TABLE A.38 – TRIM SELECTION.....	42
TABLE A.39 – DESIGN STANDARDS FOR CHECK VALVES.....	44
TABLE A.40 – SEAL GROUP MATERIALS FOR SOFT SEATED DUAL PLATE CHECK VALVE.....	44
TABLE A.41 – TRIM MATERIAL ACCORDING MATERIAL CLASS	44
TABLE A.42 – OBTURATOR TYPE FOR CHECK VALVES.....	45
TABLE A.43 – TRIM SELECTION.....	45
TABLE A.44 – DESIGN STANDARDS FOR GLOBE VALVES.....	46
TABLE A.45 – TRIM MATERIAL CLASS CONFIGURATION FOR GLOBE VALVES.....	47
TABLE A.46 – OBTURATOR TYPE FOR GLOBE VALVES.....	47
TABLE A.47 – DESIGN STANDARDS FOR BUTTERFLY VALVES	48
TABLE A.48 – NON-METALLIC MATERIALS FOR SEATS / STEM SEAL DESIGN	48
TABLE A.49 – MATERIAL CLASS CONFIGURATION FOR BUTTERFLY VALVES	49
TABLE A.50 – DISC & SEAT CONFIGURATION FOR BUTTERFLY VALVES	50
TABLE A.51 – END CONNECTION CONFIGURATION FOR BUTTERFLY VALVES CATEGORY A (CONCENTRIC)	51
TABLE A.52 – END CONNECTION CONFIGURATION FOR BUTTERFLY VALVES CATEGORY B (DOUBLE / TRIPLE OFFSET)	51
TABLE A.53 – MATERIAL CONFIGURATION FOR NON-METALLIC VALVES	51
TABLE A.54 – MINIMUM PRESSURE (PSIG) – TEMPERATURE RATING FOR NON-METALLIC BALL VALVES.....	51
TABLE A.55 – MINIMUM PRESSURE (PSIG) – TEMPERATURE RATING FOR NON-METALLIC CHECK VALVES	52
TABLE A.56 – MINIMUM PRESSURE (PSIG) – TEMPERATURE RATING FOR NON-METALLIC BUTTERFLY VALVES	52
TABLE A.57 – MINIMUM VALUES FOR TENSION TESTS	55
TABLE A.58 - MAXIMUM LEVELS OF SEVERITY BY DEFECT BY THICKNESS	57
TABLE A.59 – CHEMICAL COMPOSITION FOR ASTM A522 – TYPE I.....	63
TABLE A.60 – DESIGN VALIDATION REQUIREMENTS ACCORDING VSL CLASSIFICATION.....	64
TABLE A.61 – QSL REQUIREMENT ACCORDING VSL CLASSIFICATION	67
TABLE A.62 – TIGHTNESS CLASS FOR STEM SEALS - FUGITIVE EMISSIONS (REF.: ISO 15848 PART 1).....	69
TABLE A.63 – TIGHTNESS CLASS FOR BODY SEALS - FUGITIVE EMISSIONS (REF.: ISO 15848 PART 1).....	69
TABLE A.64 – IDENTIFICATION OF BODY MATERIAL CODE, ACCORDING RESPECTIVE MATERIAL CLASS	77
TABLE A.65 – IDENTIFICATION OF OBTURATOR TYPE, ACCORDING VALVE TYPE	78
TABLE A.66 – IDENTIFICATION OF TRIM DESIGN, ACCORDING VALVE TYPE	78

A.1. SCOPE

The scope of this document is related to axial, ball, butterfly, check, diaphragm, gate, globe, needle and plug valves, either manually actuated or operated by actuators, for use in Exploration and Production (E&P) business area, onshore and offshore, especially in oil and gas production and their process facilities.

This document specifies requirements for valves concerning the following topics: design, performance, materials, manufacturing, testing, inspection, marking, handling, storing, shipment and documentation.

This document is not applicable to control valves. I-ET-3010.00-1200-800-P4X-013 addresses main requirements for control valves and also establishes supplementary requirements for emergency Shut Down Valves (SDV) and BlowDown Valves (BDV).

The valves considered in this document may be acquired directly by PETROBRAS or through a Contract, as example EPC (Engineering, Procurement and Construction), in both cases to be used for existing facilities or new projects.

A.2. NORMATIVE REFERENCES

Note: The Standards referred herein shall be considered in their latest edition/revision.

API 594, *Check valves: Flanged, Lug, Wafer and Butt-welding*

API 598, *Valve Inspection and Testing*

API 599, *Metal Plug Valves-Flanged, Threaded and Welding Ends*

API 600, *Steel Gate Valves-Flanged and Butt-Welding Ends, Bolted Bonnets*

API 602, *Steel Gate, Globe and Check Valves for Sizes DN 100 and Smaller for the Petroleum and Natural Gas Industries*

API 607, *Fire Test for Quarter-turn Valves and Valves Equipped with Nonmetallic Seats*

API 609, *Butterfly Valves: Double-flanged, Lug – and Wafer-type*

API 6A, *Specification for Wellhead and Christmas Tree Equipment*

API 6D, *Specification for Pipeline and Piping Valves*

ASME B 1.1, *Unified Inch Screw Threads, UN and UNR Thread Form*

ASME B 18.2.1, *Square, Hex, Heavy Hex, and Askew Head Bolts and Hex, Heavy Hex, Hex Flange, Lobed Head, and Lag Screws (Inch Series)*

ASME B 18.2.2, *Nuts for General Applications: Machine Screw Nuts, Hex, Square, Hex Flange, and Coupling Nuts (Inch Series)*

ASME B 31.3, *Process piping*

ASME B1.20.1, *Pipe Threads, General Purpose (Inch)*

ASME B16.1, *Gray Iron Pipe Flanges and Flanged Fittings: Classes 25, 125, and 250*

ASME B16.10, *Face-to-face and end-to-end dimensions of valves*

ASME B16.11, *Forged fittings, socket-welding and threaded*

ASME B16.20, *Metallic Gaskets for Pipe Flanges: Ring-Joint, Spiral-Wound, and Jacketed*

ASME B16.25, *Buttwelding ends*

ASME B16.34, *Valves – Flanged, threaded and welding end*

ASME B16.47, *Large Diameter Steel Flanges: NPS 26 through NPS 60 Metric/Inch Standard*

ASME B16.5, *Pipe Flanges and Flanged Fittings: NPS 1/2 through NPS 24 Metric/Inch Standard*

ASME B31.4, *Pipeline Transportation Systems for Liquid Hydrocarbons and Other Liquids*

ASME B31.8, *Gas Transmission and Distribution Piping Systems*

ASME SA-995-04, *Specification for Castings, Austenitic-Ferritic (Duplex) Stainless Steel, for Pressure-Containing Parts*

ASME SEC VIII DIV 1 APPENDIX 7, *Examination of Steel Castings*

ASME SEC VIII DIV 1 SUB A PT UG, *General Requirements for All Methods of Construction and All Materials*

ASME Section II, Part D, *Boiler and Pressure Vessel Code (BPVC), Section II: Materials – Part D: Properties (Metric)*

ASME Section VIII, Division 1, *Boiler and Pressure Vessel Code (BPVC), Section VIII, Division 1: Rules for Construction of Pressure Vessels*

ASME Section VIII, Division 2, 2004 Edition, *Boiler and Pressure Vessel Code, Section VIII, Division 2: Alternative Rules*

ASTM A370-05, *Test Methods and Definitions for Mechanical Testing of Steel Products*

ASTM A488 / A488M-04, *Steel Castings, Welding, Qualifications of Procedures and Personnel*

ASTM A703 /A703M-04A, *Steel Castings, General Requirements, for Pressure-Containing Parts*

ASTM A781 / A781M-05, *Castings, Steel and Alloy, Common Requirements, for General Industrial Use*

ASTM A802 / A802M-95, *Steel Castings, Surface Acceptance Standards, Visual Examination*

ASTM A903 / A903M-99, *Steel Castings, Surface Acceptance Standards, Magnetic Particle and Liquid Penetrant Inspection*

ASTM A995 / A995M-98, *Specification for Castings, Austenitic-Ferritic (Duplex) Stainless Steel, for Pressure-Containing Parts*

ASTM B584, *Specification for copper alloy sand castings for general applications*

ASTM B849, *Specification for pre-treatments of iron or steel for reducing risk of hydrogen embrittlement*

ASTM B850, *Standard Guide for post-coating treatments of steel for reducing the risk of hydrogen embrittlement*

ASTM E1030-00, *Radiograph Examination of Metallic Castings*

ASTM E165-02, *Test method for Liquid Penetrant Examination*

ASTM E186-98, *Heavy-Walled (2 to 4 ½-in. [51 to 114-mm]) Steel Castings*

ASTM E280-98, *Heavy-Walled (4 ½ to 12-in. [114 to 305-mm]) Steel Castings*

ASTM E446-98, *Steel castings Up to 2 in. [51 mm] in Thickness*

ASTM E562-02, *Test Method for Determining Volume Fraction by Systematic Manual Point Count*

ASTM E94-04, *Radiograph Examination*

ASTM G48-03, *Standard Test Method for Pitting and Crevice Corrosion Resistance of Stainless Steel and Related Alloys by Use of Ferric Chloride Solution*

BS 1868, *Specification for steel check valves (flanged and butt-welding ends) for the petroleum, petrochemical and allied industries*

BS 1873, *Specification for steel globe and globe stop and check valves (flanged and butt-welding ends) for the petroleum, petrochemical and allied industries*

BS EN 1226 6-1, *Industrial valves – Testing of metallic valves Part 1: Pressure tests, test procedures and acceptance criteria – Mandatory requirements*

BS EN 12266-2, *Industrial valves – Testing of metallic valves Part 2: Tests, test procedures and acceptance criteria – Supplementary requirements*

BS ISO 7121, *Steel Ball Valves for general purpose Industrial Applications*

EN 10204, *Metallic products Types of inspection documents*

ET-3000.00-1200-956-PCI-001, *Código de Cores – Pintura*

IOGP S-562, *Supplementary Requirements to API Specification 6D Ball Valves*

IOGP S-611, *Supplementary Requirements to API 600 Steel Gate Valves and to API 603 CRA Gate Valves*

ISO 10434, *Bolted bonnet steel gate valves for the petroleum, petrochemical and allied industries*

ISO 10497, *Testing of valves – Fire type-testing requirements*

ISO 12944-9, *Paints and varnishes — Corrosion protection of steel structures by protective paint systems*

ISO 14313, *Petroleum and natural gas industries – Pipeline transportation systems – Pipeline valves*

ISO 15156 (all parts), *Petroleum and natural gas industries - Materials for use in H₂S-containing environments in oil and gas production*

ISO 15761, *Steel gate, globe and check valves for sizes DN 100 and smaller, for the petroleum and natural gas industries*

ISO 15848-1, *Industrial valves - Measurement, test and qualification procedures for fugitive emissions – Part 1: Classification system and qualification procedures for type testing of valves*

ISO 15848-2, *Industrial valves - Measurement, test and qualification procedures for fugitive emissions – Part 2: Production acceptance test of valves*

ISO 17292, *Metal ball valves for petroleum, petrochemical and allied industries*

ISO 5208, *Industrial valves – Pressure testing of metallic valves*

MSS SP-25, *Standard Marking System for Valves, Fittings, Flanges and Unions*

MSS SP-45, *Bypass and drain connections*

MSS SP-55, *Quality Standard for Steel Castings for Valves, Flanges, Fittings, and Other Piping Components - Visual Method for Evaluation of Surface Irregularities*

MSS SP-9, *Spot facing for bronze, iron and steel flanges*

MSS SP-91, *Guidelines for manual operation of valves*

NBR 15827, *Industrial Valves for Installations of Exploration, Production, Refining and Transport of Petroleum Products - Requirements for Design and Prototype Test*

NORSOK 630 Rev. 3/2004, *Material Datasheet for Piping*

A.3. TERMS AND DEFINITIONS

For the purposes of this document, the following terms and definitions apply:

A.3.1. BI-DIRECTIONAL VALVE:

Valve designed for blocking the fluid in both downstream and upstream directions.

A.3.2. CASTING CRITICAL AREAS:

The regions of castings determined by manufacturer engineering, based on valve parts highly stressed by manufacturing process and as determined by finite elements under the maximum process/operating conditions.

A.3.3. DOUBLE-BLOCK-AND-BLEED VALVE – DBB:

Single valve with two seating surfaces that, in the closed position, provides a seal against pressure from both ends of the valve with a means of venting/bleeding the cavity between the seating surfaces.

A.3.4. DOUBLE-ISOLATION-AND-BLEED VALVE - DIB:

Single valve with two seating surfaces, each of which, in the closed position, provides a seal against pressure from a single source, with a means of venting/bleeding the cavity between the seating surfaces.

DIB-1 valves have both seats bidirectional. Vent or relief of valve cavity shall be obtained by use of an external relief valve.

DIB-2 valves have one seat unidirectional and one seat bidirectional. Further details are listed in A.7.1.4.

A.3.5. THROUGH-CONDUIT VALVE:

Valve with an uninterrupted and continuous cylindrical opening. Consequently, there are no cavities or large gaps in the bore between seats and body closures or between seats and obturator.

A.3.6. FULL-BORE VALVE:

Valve with an unobstructed opening, not smaller than the internal bore of the end connections.

A.3.7. SEATING SURFACES:

Contact surfaces of the obturator and seat which ensure valve sealing.

A.3.8. PRESSURE CLASS:

Numerical pressure design class, expressed in accordance with either the nominal pressure (PN) class or the ASME rating class.

A.3.9. PITTING RESISTANCE EQUIVALENT NUMBER (PREN):

Empiric Mathematical Formula that correlates pitting corrosion resistance with the amounts alloying elements in the steel that contribute to increase this resistance. For duplex steels it shall be calculated as follows:

$$\text{PREN} = \%Cr + 3,3 \times (\%Mo + 0,5 \times \%W) + 16 \times \%N.$$

A.3.10. PILOT CASTING:

For the customer purpose, any casting that is the first of its model or of a new or modified project, using the same casting procedure (same casting) as the ones it represents.

A.3.11. CASTING:

Any component of a valve, made by casting.

A.3.12. NOMINAL TORQUE OF OPERATION – TNO:

It is the actual value of torque needed to operate the valve, under any operation condition. This value shall be presented in the marking (plate) of the valve.

A.3.13. MAXIMUM TORQUE OF OPERATION – TMO:

It is the maximum value of torque that may be applied on the valve, without damaging the override mechanism (i.e.: no plastic deformation on the drive train). This value of torque shall present the safety margin of the actuator, to be applied only under special situation such as a contingency (e.g.: when the valve is not opening / closing with TNO value). Typically, TMO is 150% TNO.

A.3.14. MAXIMUM ALLOWABLE TORQUE – TMA:

It is the value of torque that may be applied on the valve, after that it shall start damaging the override mechanism (i.e.: plastic deformation on the drive train).

A.4. SYMBOLS AND ABBREVIATED TERMS

For the purposes of this document, the following symbols and abbreviated terms apply:

ADV	anti-columning deluge valve
CRA	corrosion resistance alloy
DBB	double block and bleed
DIB-1	double isolation and bleed. Both seats bidirectional (DPE)
DIB-2	double isolation and bleed. One seat uni-directional (SPE or SR) and one seat bidirectional (DPE)
DN	nominal size
DPE	double piston effect
EPC	engineering, procurement and construction
FAT	factory acceptance test
HIPPS	high integrity pressure protection system
HP	high pressure
HVOF	high velocity oxygen fuel
ID	internal diameter
ITP	inspection and testing plan
LCF	contractual list of supply
LP	low pressure
LPI	liquid penetrant inspection
MWP	maximum working pressure
NDT	nondestructive testing
NPS	nominal pipe size
PFD	probability of failure on demand

PST	partial stroke testing
PVT	performance verification test
QSL	quality specification level
RGD	rapid gas decompression
SDV	shut down valve
SIF	safety instrumented function
SIL	safety integrity level
SIP	shut in pressure
SPE	single piston effect
SR	self-relief
TMA	maximum allowable torque
TMO	maximum torque of operation
TNO	nominal torque of operation
UNS	unified numbering system
VAG	needle valve
VAX	axial valve
VBO	butterfly valve
VCI	volatile corrosion inhibitor
VDE	double ball valve
VDI	diaphragm valve
VDS	valve datasheet
VES	ball valve
VGA	gate valve
VGL	globe valve
VMA	plug valve
VRE	check valve
VSL	valve specification level
WPS	welding procedure specifications
WPQR	welding performance qualification record

A.5. VALVE SELECTION GUIDE

A.5.1. INTRODUCTION

A.5.1.1. In this item is presented general information, such as a guide of how shall be conducted the engineering process to select a valve for use in the Project and/or specific application.

A.5.1.2. The indication of all valves shall be driven by the definition of Valve Specification Level (VSL), which regulates the specification of an adequate valve for a certain application, taking into account the criticality foreseen in the application/use of the valve.

A.5.1.3. The VSL classification will provide specific requirements for four valve specification levels (VSLs): VSL-1, VSL- 2, VSL-3, VSL-4. These four VSL designations define different levels of technical / quality requirements.

A.5.1.4. The determination of the VSL is obtained by the classification rules stated on item A.5.2.

A.5.1.5. All VDS presented herein are formulated according its specific VSL indication. Design premises, such as materials (metallic / non-metallic), configurations, tests and design validation are based on the criticality foreseen in the application/use of the valve and defined by the specific VSL.

A.5.1.6. For any given VSL, there is a set of requirements associated with it (item A.5.3).

A.5.1.7. The manufacturer of the valve shall attend all requirements listed in the VDS, including the specific requirements of VSL.

A.5.1.8. It is possible to have more than one type of valve (e.g.: ball, gate, etc.) with the same VSL number, and possibly both types would be able to attend a certain application. In this case, it shall be conducted by the Project and/or user an evaluation of the valve features associated with the foreseen application, and so define the type of valve that shall be specified in the Project and/or specific application.

A.5.1.9. The valve's feature are presented in item A.5.4, and allows an adequate understanding about which type of valve is more suitable for the intended application.

A.5.2. VALVE SPECIFICATION LEVEL (VSL) - CLASSIFICATION

A.5.2.1. The VSL classification shall be taken according premises indicated in this item. It shall be evaluated the following parameters by the Project and/or user:

Application: it shall be verified the application of the valve. Safety valves (e.g.: HIPPS, SDVs, etc.) have a deterministic VSL, not depending on complementary analyses such as established for other type of valves.

- a) Table A.2 describes this evaluation.

Service: it shall be verified the service conditions where the valve will be installed. Services such as hydrocarbon, hot water, toxic or inflammable shall classify a higher grade of VSL.

- b) Table A.2 describes this evaluation.

- c) Accumulated energy: it shall be verified the classification of accumulated energy associated with the use of the valve, as described in Table A.1.

- d) Demand: the expected number of cycles during the lifetime of the valve shall be taken into account when considering the VSL. The higher the number, the higher the VSL, as described in Table A.1.

Table A.1 – Classification of accumulated energy and high demand valves

Accumulated Energy	High	Valves of Pressure Class 600 and 900, NPS ≥ 6 Valves of Pressure Class 1500, 2500 and 10.000psi
	Low	Valves of Pressure Class 125, 150 and 300 Valves of Pressure Class 600 and 900, NPS ≤ 4
High Demand	Actuated Filter valves, Actuated XVs, Actuated molecular sieve valve	

Table A.2 – Valve Specification Level (VSL) classification

Safety Valves	Application		Level	
	HIPPS, SDV Platform limits		VSL-4	
	SDV, BDV, L/R PIG (Note 1)		VSL-3	
	ADV, ADV Block		VSL-2	
Other valves	Service (Note 2)	Accumulated Energy	High Demand	
			Yes	No
	Hydrocarbon Hot water Inflammable Steam Toxic	High	VSL-3	VSL-2
		Low		
	Other services	High	VSL-2	VSL-2
		Low		VSL-1
Note 1 – This table is not applicable for valves in tubing specifications. Note 2 – See below the fluids belonging to each service: <ul style="list-style-type: none"> - Hydrocarbon/Inflammable/Toxic: AM, CI, CI2, CN, CNI, D, DF, DFC, DOH, F, FG, G, GL, H, IGN, JF, OL, P, PC, PCG, PLD, TR; - Hot water: HWP; - Steam: S; - Other services: ADW, AO, BG, BR, BWG, BWH, CHW, CV, DA, DO, DTH, DW, EG, FL, FLC, FP, FW, GW, HF, HWP, HWU, IA, IG, IN, IW, IWC, PCW, PW, PWH, SA, SC, SFW, SN, SP, STA, SW, TC, TL, W, WW. 				

A.5.3. VALVE SPECIFICATION LEVEL (VSL) - REQUIREMENTS

A.5.3.1. Each VSL classification inputs to the valve design a basic information about which API 6D - Quality Specification Level (QSL) shall be fulfilled, plus a sort of specific requirements (mandatory).

A.5.3.2. The QSL classification and requirements are according API 6D: QSL-1, QSL-2, QSL-3 or QSL-4. All requirements listed in API 6D Annex J shall be attended according the respective QSL related to the VSL.

A.5.3.3. The QSL refers to specific requirements for NDT, pressure testing and documentation of the valve.

A.5.3.4. The VSL requirements shall be as described in Table A.3:

Table A.3 – Valve Specification Level (VSL) requirements

VSL Requirements	VSL-1	VSL-2	VSL-3	VSL-4
QSL (According API 6D)	QSL-2	QSL-3 (Note 1)	QSL-3	QSL-4
Fugitive Emissions Design (According item A.6.1.6)	No	Yes / No (Note 2)	Yes / No (Note 2)	Yes / No (Note 2)
Fire Resistant (According item A.6.1.4)	No (Note 3)	Yes / No (Note 4)	Yes / No (Note 5)	Yes
Design Validation (According item A.9.2)	No	Design analytical approval	Design validation test approval (PVT)	
SIL Capable (According item A.6.1.7)	No	No	No	Yes / No (Note 6)

Note 1– For liquid service application, it may be considered QSL-2, except for hydrocarbon.
 Note 2– The valve design shall be fugitive emissions approved if the valve will be specified for use in a process pipe that fluid contains volatile organic compounds (e.g.: benzene), and its emissions to environment are limited by a regulatory law.
 Note 3– If fire resistant requirement is requested by the Project, it shall be considered the use of a VSL-2 valve.
 Note 4– Indication of fire resistant valve shall be taken according design premises.
 Note 5– SDV, BDV and XV valves shall be fire tested. For other valves, indication of fire-tested valve shall be taken according design premises.
 Note 6– SIL capable applies only for HIPPS valve.

A.5.4. VALVE FEATURES AND TYPICAL APLICATIONS

A.5.4.1. For each type of valve, Table A.4 presents a summary of valve features and typical applications.

Table A.4 - Valve features and typical applications

Features	Ball			Gate			Check			Globe	Butterfly			Axial	Plug	Needle	Diaphragm
	Soft to Metal	Metal to Metal	Rising Stem (Metal to Metal)	Solid Wedge	Expanding	Slab	Piston	Dual Plate	Swing	Axial (Non-slam)	Hamfer Disc	Category A (concentric)	Category B (bi-eccentric)	Category B (tri-eccentric)			
Manual operator design (e.g.: wrench, hand/heel gearbox)	A	A	A	A	A	A	N/A	N/A	N/A	N/A	A	A	A	A	A	A	N/A
Actuated design (e.g.: hydraulic, electric, pneumatic)	A	A	A	A	A	A	N/A	N/A	N/A	N/A	A	A	A	A	A	N/A	A
Soft seated design	Yes	No	N/A	No	A	No	No	A	No	A	No	Yes	No	No	Yes	No	Yes
Metal to Metal seat design	No	Yes	Yes	Yes	A	Yes	Yes	A	Yes	A	Yes	No	Yes	Yes	No	Yes	No
Piggable	Yes	Yes	No	No	Yes	Yes	No	No	N/A	No	No	No	No	No	No	No	No
Bidirectional	Yes	Yes	No	Yes	Yes	Yes	No	No	No	No	No	No	No	No	Yes	No	No
Double block and bleed (i.e.: DBB)	A	A	No	No	A	No	No	No	No	No	No	No	No	No	A	No	No
Double isolation and bleed (i.e.: DIB-1, DIB-2)	A	A	No	No	No	No	No	No	No	No	No	No	No	No	No	No	No
Fire tested design	A	A	Yes	N/A	A	N/A	N/A	N/A	N/A	N/A	N/A	No	A	A	A	N/A	No
Fire safe design	N/A	N/A	N/A	A	N/A	A	A	A	A	A	A	No	N/A	N/A	N/A	A	No
Fugitive emissions design	A	A	N/A	N/A	N/A	N/A	N/A	N/A	N/A	N/A	N/A	N/A	N/A	N/A	N/A	N/A	N/A
Fit to control application	N/A	N/A	N/A	N/A	N/A	N/A	N/A	N/A	N/A	N/A	P	N/A	N/A	N/A	N/A	P	N/A
Fit to abrasive service (solids in suspension)	N/A	P	ALT	N/A	N/A	ALT	N/A	N/A	N/A	N/A	N/A	N/A	N/A	ALT	N/A	N/A	N/A
Fit to Safety Instrumented System (SIS) (e.g.: HIPPS application)	N/R	P	N/R	N/R	N/R	N/R	N/R	N/R	N/R	N/R	N/R	N/R	N/R	ALT	N/R	N/R	N/R
SIL capable design	N/A	A	N/A	N/A	N/A	N/A	N/A	N/A	N/A	N/A	N/A	N/A	N/A	A	N/A	N/A	N/A
Fit to SDV Platform Limits	N/R	A	N/R	N/R	N/R	A	N/R	N/R	N/R	N/R	N/R	N/R	N/R	N/R	N/R	N/R	N/R
Fit to SDV, BDV application (Hydrocarbon service)	N/R	A	N/R	N/R	N/R	A	N/R	N/R	N/R	N/R	N/R	N/R	N/R	A	N/R	N/R	N/R
Fit to SDV, BDV application (Non-hydrocarbon service)	A	A	N/R	N/R	N/R	A	N/R	N/R	N/R	N/R	N/R	N/R	N/R	A	N/R	N/R	N/R
Fit to L/R PIG application	N/R	A	N/R	N/R	N/R	N/R	N/R	N/R	N/R	N/R	N/R	N/R	N/R	N/R	N/R	N/R	N/R
Fit to molecular sieve application	N/R	N/R	P	N/R	N/R	N/R	N/R	N/R	N/R	N/R	N/R	N/R	N/R	ALT	N/R	N/R	N/R
Fit to ADV application	N/R	N/R	N/R	N/R	N/R	N/R	N/R	N/R	N/R	N/R	N/R	N/R	A	N/R	N/R	N/R	A

Legend: A – Available; ALT – Alternative solution; P – Preferential solution; N/R – Not Recommended; N/A – Not Available

A.6. GENERAL DESIGN REQUIREMENTS

A.6.1. VALVE

A.6.1.1. GENERAL

A.6.1.1.1. Regarding documentation hierarchy, valve design shall be according the Standard referenced in the VDS. In case of conflict between the requirements herein established and that Standard, the attendance of this document shall be considered as mandatory.

A.6.1.1.2. The valve design shall attend all quality, functional, materials, testing, and configuration requirements specified in the VDS.

A.6.1.1.3. The assembly of the valve / actuator shall meet all operating conditions, in any position of installation, without performance reduction. Unless clearly specified, it shall be able to operate under full rated condition, such as opening and closing at full differential pressure, according to the design pressure indicated in the VDS.

A.6.1.1.4. For a heavy weighted valve (Weight > 25 kg) or a valve with larger dimensions (L+W+H > 1500 mm), the corresponding design shall consider the use at least of four (4) lifting handles. The vertical line of the lifting points shall be left free to avoid interference with the drive system or actuator.

A.6.1.1.5. The manufacturer shall present all dimensional drawings of the valve and actuator, with a list of all parts and materials specifications.

A.6.1.1.6. The manufacturer shall present a list of required torques on the valve shaft, containing the following values of torque: Nominal Torque of Operation (TNO), Maximum Torque of Operation (TMO) and Maximum Allowable Torque (TMA), taking into account the pressure class of the valve and temperature limits.

Note: for gate and globe valves with manual actuation, TNO shall be according MSS SP-91; for ball valves, the TNO shall comply with API 6D; and for butterfly valves, the TNO shall be according API 609.

A.6.1.1.7. The manufacturer shall inform in the documentation all design and/or operation constraints (e.g.: installation position, flow direction, flow rate, limits of pressure, temperature and metallic / non-metallic materials, etc.).

A.6.1.1.8. Valve ID (bore) shall be compatible with the ID of the pipes and accessories in which the valve is installed.

A.6.1.1.9. All metallic materials shall have a mill certification, with registers of chemical composition, mechanical properties and other standards requirements, besides the manufacturer batch identification.

A.6.1.1.10. For valve designs which allows retained pressure in body cavity (when valve is fully closed or fully open), plugs capable to mitigate risk of an accident under an eventual remotion shall be used. In this case, those ports shall be closed with plugs having a constructive configuration that allows pressure relieving to atmosphere (relief hole) during the beginning of plug remotion, serving as an alert to the operator about the remaining pressure inside the valve body. An example of this kind of configuration is showed as follows:

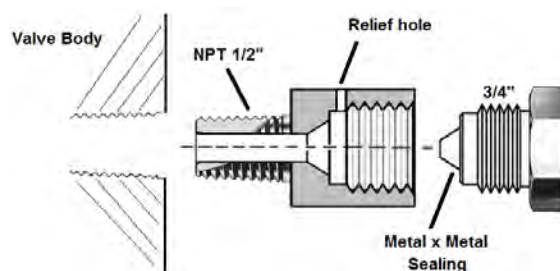

Figure A.1 – Example of use of drain and vent plug

A.6.1.2. MATERIAL CLASSES

A.6.1.2.1. The design of the valves shall attend one of the following classification of material classes:

Table A.5 – Material classes

#	Material Class
C	Carbon Steel
A	Alloy Steel
S	Stainless Steel
D	Duplex Steel
N	Nickel Alloy
U	Uncommon materials

A.6.1.3. BODY MATERIAL

A.6.1.3.1. The referred letter of the material class of the valve, shown on the first column of Table A.5, associated with the number indicated in the lines of Table A.6, gives the body material considered in the valve design. The combination of the letter and number shall be considered as a part of the valve code, according description of valve code presented on item A.11.5.

Table A.6 – Body material, according to material class

Body Material	Material Class					
	C	A	S	D	N	U
	Carbon steel	Alloy steel	Stainless steel	Duplex steel	Nickel alloys	Uncommon materials
1	ASTM A105 or ASTM A216 WCB	ASTM A350 LF3 or ASTM 352 LC3	ASTM A182 Gr. F304 or ASTM A351 Gr. CF8	ASTM A995 Gr. 1B	Inconel 625 (UNS N06625)	Bronze
2	A350 LF2 CL1 or ASTM A352 LCB	ASTM A182 F5	ASTM A182 Gr. F316 or ASTM A351 Gr. CF8M	ASTM A182 Gr. F51 or ASTM A995 Gr. 4A	-	ASTM A536-65-45-12
3	ASTM A105 or ASTM A216 WCB + Organic Coating (Onshore use only)	ASTM A182 F11 CL2	ASTM A182 Gr. F317 or ASTM A351 Gr. CG8M	ASTM A182 Gr. F55 or ASTM A995 Gr 6A	-	ASTM B148 (UNS C95800)
4	ASTM A105 or ASTM A216 WCB + Organic Coating (Offshore)	ASTM A522 Type I	ASTM A182 Gr. F347 or ASTM A351 Gr. CF8C	-	-	Plastics

Body Material	Material Class					
	C	A	S	D	N	U
	Carbon steel	Alloy steel	Stainless steel	Duplex steel	Nickel alloys	Uncommon materials
5	ASTM A105 or ASTM A216 WCB + Full Clad Inconel 625 overlay (UNS N06625)	ASTM A350 LF3 or ASTM A352 LC3 + Full Clad Inconel 625 overlay (UNS N06625)	-	-	-	Gray Iron
6	ASTM A350 LF2 CL1 or ASTM A352 LCB + Full Clad Inconel 625 overlay (UNS N06625)	ASTM A522 Type I + Full Clad Inconel 625 overlay (UNS N06625)	-	-	-	-

A.6.1.3.2. The use of forgings or castings for the body material shall follow the following classification according the VSL of the valve, and indicated in the VDS:

Table A.7 – Process fabrication for body materials according to VSL

VSL	Pressure Class						
	150	300	600	900	1500	2500	10000
VSL-1	Forging or Casting				Forging (Note 1)		
VSL-2							
VSL-3	Forging (Note 1)						
VSL-4							
Note 1 - Except for axial block valves (VAX) and Triple Offset Butterfly valves made of NIAIBr (UNS C95800), for which casting is acceptable.							

A.6.1.4. FIRE TESTED VALVES

A.6.1.4.1. In order to obtain indication that the valve design shall be fire tested type, it shall be fulfilled all requirements listed in DR-ENGP-I-1.3, such as the execution of the “Risk Assessment and Safety Studies” (item 5 of DR-ENGP-I-1.3) and the “Consequence Analysis - (fire propagation, gas dispersion, explosion, etc.)”.

A.6.1.4.2. Whenever specified in the VDS that the valve shall be fire tested, its design shall be submitted to a certification by testing a prototype according to ISO 10497, API 6FA or API 607 (except 4th edition).

A.6.1.4.3. The manufacturer shall present to PETROBRAS the correspondent certificate and the valve shall be marked as described on item A.6.1.10.

A.6.1.4.4. The design of the seals on seats/body and stem areas shall consider mandatory the use of a metallic element or an element made by graphite, to guarantee the attendance of the fire testing requirement. This element shall be installed on each leakage path of the valve.

A.6.1.5. FIRE SAFE VALVES

A.6.1.5.1. In order to obtain indication that a valve design shall be fire safe type, it shall be fulfilled all requirements listed in DR-ENGP-I-1.3, such as the execution of the “Risk Assessment and Safety Studies” (item 5 of DR-ENGP-I-1.3) and

the “Consequence Analysis - (fire propagation, gas dispersion, explosion, etc.)”.

A.6.1.5.2. Whenever specified in the VDS that the valve shall be fire safe, its design shall contain material specification applying materials that are capable of withstanding exposure to fire without failure.

A.6.1.5.3. The fire safe design does not require valve certification, but it shall guarantee that the valve design is resistant to a fire scenarium.

A.6.1.5.4. The design of the seals on seats/body and stem areas shall consider mandatory the use only of a metallic element or an element made by graphite, to guarantee the attendance of the fire safe requirement.

A.6.1.6. FUGITIVE EMISSIONS

A.6.1.6.1. In order to prevent a failure on a valve (e.g.: leaking toxic fluid to external environment), that could contribute to the minimize safety to personnel, installation and/or environment, some valves shall be designed to be fugitive emissions approved.

A.6.1.6.2. Whenever specified in the VDS that the valve shall be fugitive emission approved, its design shall be certified according ISO 15848 Part 1, by prototype approval to confirm that an adequate design of seals (on body joints and stem) is provided.

A.6.1.6.3. The manufacturer shall prepare specific Performance Verification Test (PVT) procedure, according ISO 15848 Part 1, and submit for PETROBRAS approval.

A.6.1.6.4. The manufacturer shall provide the certificate of approval containing information about the design “Performance Class” according ISO 15848 Part 1. Information about “Tightness Class”, “Endurance Class”, and “Temperature Class” shall be presented in details.

A.6.1.6.5. The “Tightness Class” shall be according:

Table A.8 – Tightness class for stem seals - fugitive emissions (ref.: ISO 15848 Part 1)

Class	Measured leak rate (mass flow)	Measured leak rate (mass flow)	Measured leak rate (volumic flow)	Remarks
	mg.s ⁻¹ .m ⁻¹ stem perimeter (for information)	mg.s ⁻¹ .m ⁻¹ stem diameter through stem seal system	mbar.l.s ⁻¹ per mm stem diameter through stem seal system	
AH ¹	≤ 10 ⁻⁵	≤ 3,14.10 ⁻⁸	≤ 1,78.10 ⁻⁷	Typically achieved with bellow seals or equivalent stem (shaft) sealing system for quarter turn valves
BH ²	≤ 10 ⁻⁴	≤ 3,14.10 ⁻⁷	≤ 1,78.10 ⁻⁶	Typically achieved with PTFE based packings or elastomeric seals
CH ²	≤ 10 ⁻²	≤ 3,14.10 ⁻⁵	≤ 1,78.10 ⁻⁴	Typically achieved with flexible graphite based packings

¹ Expressed by the vacuum method as defined in ISO 15848 Part 1 - Annex A.
² Measured by the total leak rate measurement method (vacuum or bagging) as defined in ISO 15848 Part 1 - Annex A.

Table A.9 – Tightness class for body seals - fugitive emissions (ref.: ISO 15848 Part 1)

Measured leakage (Body seals)	≤ 50 ¹
¹ Expressed in ppmv measured with the sniffing method as defined in ISO 15848 Part 1 - Annex B	

Table A.10 – Tightness class for stem (or shaft) seals with methane - fugitive emissions (ref.: ISO 15848 Part 1)

Class	Measured leakage ppmv (sniffing method according ISO 15848 Part 1 - Annex B)
AM	≤ 50
BM	≤ 100
CM	≤ 500

¹ Expressed in ppmv measured with the sniffing method as defined in ISO 15848 Part 1 - Annex B

Table A.11 – Leakage from body seals with methane - fugitive emissions (ref.: ISO 15848 Part 1)

Measured leakage ppmv (sniffing method according ISO 15848 Part 1 - Annex B)
≤ 50

A.6.1.6.6. The Mechanical-cycles shall be performed according ISO 15848 Part 1, considering the following “Endurance Class” x VSL:

Table A.12 – Endurance class according VSL classification

Endurance Class (as defined in ISO 15848 Part 1 - Annex B)	VSL-1	VSL-2	VSL-3	VSL-4
	-	CO1	CO2	CO2

A.6.1.6.7. The “Temperature Class” shall be according:

Table A.13 – Temperature class of fugitive emissions (ref.: ISO 15848 Part 1)

(t-196 °C)	(t-46 °C)'	(tRT)	(t200 °C)	(t400 °C)
-196 °C	-46 °C	Room temperature, °C	200 °C	400 °C

A.6.1.7. SAFETY INTEGRITY LEVEL

A.6.1.7.1. The concept of Safety Integrity Level (SIL) shall be applied for valves dedicated to a HIPPS system.

A.6.1.7.2. The SIL is a representation of the required safety unavailability (average probability of failure on demand - PFD) of a safety instrumented function (SIF).

A.6.1.7.3. The SIL classification shall be as listed in Table A.14, where SIL 4 has the highest level of safety integrity, and SIL 1 has the lowest.

Table A.14 – SIL levels

SIL	PFD	Availability	Risk Reduction Factor
SIL 1	0,1 to 0,01	0,90 to 0,99	10 to 100
SIL 2	0,01 to 0,001	0,99 to 0,999	100 to 1000
SIL 3	0,001 to 0,0001	0,999 to 0,9999	1000 to 10.000

SIL 4	0,0001 to 0,00001	0,9999 to 0,99999	10.000 to 100.000
--------------	-------------------	-------------------	-------------------

A.6.1.7.4. Whenever requested in the VDS, such as for HIPPS valve, the SIL to be considered in the design of the valve shall be SIL-3. The manufacturer shall present all documentation in order to certify that SIL 3 requirements were achieved for the valve design.

A.6.1.8. BOLTING

A.6.1.8.1. The Studs, bolts and nuts used in the body-closure and body-bonnet shall be according:

Table A.15 - studs, bolts and nuts material specification

Body Material	Studs / Bolts Material	Nuts	Coating
ASTM A105 ASTM A216 Gr. WCB	ASTM A193 Gr. B7	ASTM A194 Gr. 2H	According item A.6.1.8.2
ASTM A350 Gr. LF2 CL1 ASTM A352 Gr. LCB	ASTM A320 Gr. L7	ASTM A194 Gr. 4L or 7L	
ASTM A350 Gr. LF3 CL1 ASTM A352 Gr. LC3	ASTM A193 Gr. B8M or ASTM A193 Gr. B8M CL2	ASTM A194 Gr. 8M	N/A
ASTM A182 Gr. F11 CL2 ASTM A217 Gr. WC6 ASTM A182 Gr. F5 ASTM A217 Gr. C5	ASTM A193 Gr. B16	ASTM A194 Gr. 7	According item A.6.1.8.2
ASTM A182 Gr. F316 ASTM A351 Gr. CF8M ASTM A182 Gr. F317 ASTM A351 Gr. CG8M ASTM A182 Gr. F347 ASTM A351 Gr. CF8C	ASTM A193 Gr. B8M or ASTM A193 Gr. B8M CL2	ASTM A194 Gr. 8M	N/A

A.6.1.8.2. The studs, bolts and nuts shall be coated with zinc-nickel (Zn-Ni) according ASTM B841, Class 1, Type B / E, Grade 5-8, with post-coating hydrogen embrittlement relief, according ASTM B 849 and ASTM B 850;

A.6.1.8.3. For studs and bolts according ASTM A320 Gr L7, and the valve body material is ASTM A350 Gr LF2 CL 1 or ASTM A352 Gr LCB, it will be acceptable charpy impact testing at -45°C. If the valve body material is ASTM A350 Gr LF3 or ASTM A352 Gr LC3, it will be acceptable charpy impact testing at -60°C;

A.6.1.8.4. The studs used in the body-closure (ball, check and plug) and body-bonnet (gate and globe) shall be according ASME B1.1, UNC-2A up to 25,40mm (1") and 8UN-2A, from 28,57mm (1 1/8") up, with standard hex nuts according ASME B18.2.2, with a minimum of four. The length of the studs shall have minimum of one and maximum of three screw threads beyond the nut. For valves with DN 40 (1 1/2") and smaller, is allowed the use of bolts according ASME B18.2.1.

Alternatively, studs, bolts and nuts may be according metric units;

A.6.1.8.5. Valves subjected to fire type-testing shall be assembled with studs, bolts and nuts according Table A.15. For the cases not covered in Table A.15, the manufacturer shall properly specify bolting materials. In this case, this set shall be used for fire type-testing. As an alternative of ASTM A193 Gr B7, studs made of ASTM A193 Gr B16 may be used, considering coating requirements indicated in item A.6.1.8.2.

A.6.1.8.6. Studs, bolts and nuts made of austenitic stainless steel (e.g.: Type 316) shall not be used when exposed to wet marine atmosphere with maximum operating temperature above 60°C if. As an alternative, ASTM A193 Gr. B7 may be used.

A.6.1.9. PAINTING

A.6.1.9.1. If painting of the valve is contractual required, the manufacturer shall present for PETROBRAS approval the Painting Inspection Plan, according PETROBRAS’s specification and approved by a Painting Inspector Level II;

A.6.1.9.2. It shall be documented all painting inspection registers, and submitted for PETROBRAS;

A.6.1.9.3. The color to be applied on the valves shall according DR-ENGP-M-I-1.15.

A.6.1.9.4. Coating systems specified for offshore and coastal applications shall be selected in accordance with ISO 12944-9 corrosion category CX high durability and I-ET 3010.00-1200-956-P4X-002.

A.6.1.10. MARKING AND NAMEPLATE

A.6.1.10.1. All valves shall be marked in accordance with the requirements stated on the design Standard referenced in the VDS.

A.6.1.10.2. Each valve shall be provided with an austenitic stainless steel nameplate securely affixed and so located that it is easily accessible.

A.6.1.10.3. The nameplate shall present information in accordance with the requirements stated on the design Standard referenced in the respectively VDS, plus the additional data:

A.6.1.10.3.1. Indication about the VSL of the valve, such as: VSL-1, VSL-2, VSL3 or VSL-4.

A.6.1.10.3.2. Indication about fire tested design (when applicable).

A.6.1.10.3.3. Indication about fugitive emissions design (when applicable).

A.6.1.10.4. For trunnion mounted ball valves, despite of the separate identification plate requested by API 6D to indicate the direction of seats valves with one unidirectional seat and one bidirectional seat, each valve shall present a separate identification plate indicating the seat configuration, such as illustrated in Figure A.2.

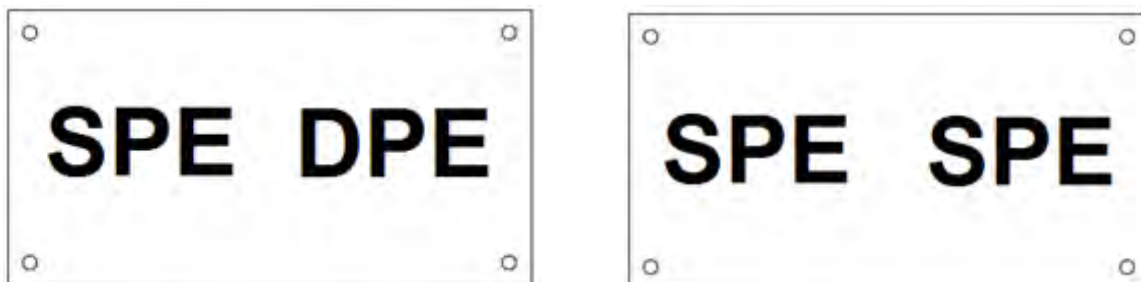

For SPE / DPE seats

For SPE / SPE seats

Figure A.2 – Example of nameplates with indication of seat configuration

A.6.1.10.5. Valves designed with unidirectional flow capability, i.e. flow occurs only in one direction, shall be marked with

a flow direction arrow or with a separate identification plate fixed to the body, indicating the direction for which flow is permitted.

A.6.2. ACTUATOR

A.6.2.1. GENERAL

A.6.2.1.1. In general, all VDS contain technical specification considering manual actuated valves. The actuation for manual valves may be as a wrench, hand wheel or gearbox operator.

A.6.2.1.2. Other types of actuators, such as hydraulic, pneumatic or electric, may be considered by PETROBRAS to be used. In this case, the manufacturer shall design the valve and actuator considering also the specific datasheet.

A.6.2.1.3. When applicable (i.e.: control valve, SDV and BDV), the design of actuators shall consider the requirements stated in I-ET-3010.00-1200-800-P4X-013 - General Criteria for Instrumentation Projects.

A.6.2.1.4. When applicable, the actuator shall be equipped with a positioning indicator, in order to show correct and clearly the position of the valve (open or close). The position of a wrench or indicator shall be in the direction of the line/bore when the valve is open and be perpendicular to the line/bore when the valve is closed.

A.6.2.1.5. For gearbox operator, the connection between the valve body and the gearbox shall be vented so that any leakage from the stem cannot penetrate into the gearbox housing.

A.6.2.1.6. In case hydraulic actuator is considered, the manufacturer shall design it in order to have a maximum operating pressure (e.g.: opening under full differential pressure) of 90% of the nominal operating pressure.

A.6.2.1.7. The actuator shall be designed with a safety factor of 2 times the nominal torque during normal operation condition (maximum available torque = 2 x nominal torque).

A.6.2.1.8. For hand wheel actuated valves, the hand wheel shall be designed to allow operation of the valve under full differential pressure. It shall also attend the requirements listed in MSS SP-91.

A.6.2.1.9. Levers and handwheels shall be in grade 316 stainless steel material.

A.6.2.2. ACTUATOR TYPE

A.6.2.2.1. Unless otherwise specified, the actuator type shall be according:

Table A.16 – Actuators type

Type	Pressure Class	Use of Gearbox x DN(NPS) ≥
Gate	150	300 (12)
	300	250 (10)
	600	150 (6)
	900	100 (4)
	1500, 2500	80 (3)
Globe	150, 300	200 (8)
	600, 900	100 (4)
	1500, 2500	80 (3)

Type	Pressure Class	Use of Gearbox x DN(NPS) ≥
Ball	150, 300	150 (6)
	600, 900	100 (4)
	1500, 2500	50 (2)
Butterfly Category A (concentric)	CWP and 150	250 (10)
Butterfly Category B (bi-eccentric / triple-eccentric)	150 and 300	200 (8)
	600	160 (6)
Plug	150, 300	150 (6)
	600, 900	100 (4)

A.7. SPECIFIC DESIGN REQUIREMENTS

A.7.1. BALL VALVE

A.7.1.1. DESIGN REQUIREMENTS

A.7.1.1.1. The valve shall be designed to operate and seal, according design premises, under the following conditions:

- a) high pressure, equivalent to MWP, being able to operate and seal with high and low differential pressure.
- b) low pressure, equivalent to LP of specific QSL requirement, being able to operate and seal with a low differential pressure.

A.7.1.1.2. The type of the seats, regarding SPE or DPE, shall be used in the assembly of the valve in order to guarantee the isolation valve configuration specified in the VDS (i.e.: DBB, DIB-1 or DIB-2). Any deviation shall be submitted for PETROBRAS approval.

A.7.1.1.3. All sealings specified for the body construction shall be bi-directional, and no visible leakage shall be considered to external environment.

A.7.1.1.4. The sealing type of the valve, regarding Metal to Metal or Soft sealing, shall be according the indication in the VDS. Any deviation shall be submitted for PETROBRAS approval.

A.7.1.1.5. A Metal to Metal seated ball valve consists exclusively in use of a metal to metal sealing between seats and ball, without the use of a non-metallic insert;

A.7.1.1.6. A soft seated ball valve consists in use of a non-metallic insert to guarantee its sealing performance. In this case, the seat insert design and its groove shall be designed in order to prevent extrusion under all operation conditions.

A.7.1.1.7. Whenever specified in the VDS, the manufacturer shall attend to the metallic coating specified for the sealing surfaces, such as in the body, bonnet, ball, seats, etc. In this case, the manufacturer shall attend the applicable requirements listed on items A.7.1.7.3 and A.8.

A.7.1.1.8. Whenever specified in the VDS, the manufacturer shall attend to the hard coating specified for the sealing surfaces, such as in the ball and seats. In this case, the manufacturer shall attend the applicable requirements listed on items A.7.1.7.4 and A.8.2.2.

A.7.1.1.9. Whenever specified in the VDS, the manufacturer shall attend to the organic coating specified. In this case, the manufacturer shall attend the applicable requirements listed on item A.8.2.2.4.

A.7.1.1.10. Valves with NPS 3 (DN 80) and smaller may have a single drain and vent connection, at the lowest possible position on the valve body cavity. Valves NPS 4 and higher shall contain both drain and vent ports, in order to allow drain, purge, pressurization and monitoring through the body during testing. MSS SP45 shall be considered, with the additional requirements:

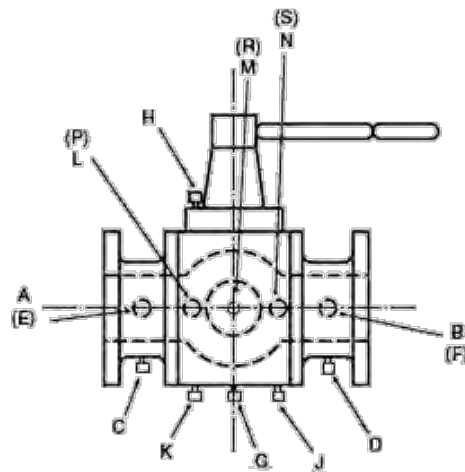

Figure A.3 - Location of drain and vent ports

- a) For trunnion ball valves, the body shall contain a threaded hole with drain plug in position "G" or "J", according Figure A.3. It is not allowed to mount plugs using PTFE tape.
- b) The plug shall be specified considering the alert given in A.6.1.1.10.

A.7.1.1.11. For trunnion ball valves type DIB-1, or when requested in the VDS, it shall be provided with an automatic cavity-pressure relief. In this case, it shall be considered the use of a block valve before the cavity-relief valve.

A.7.1.1.12. For floating ball valves (NPS ≥ 2) and for trunnion ball valves, it shall be designed in order to allow pressure relief in the cavity from exceeding 1,33 times the valve pressure rating at the specified maximum operating temperature.

A.7.1.1.13. The ball shall be full bore type, cylindrical and solid as shown in Figure A.4.

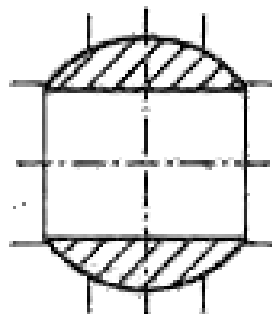

Figure A.4 – Ball type

A.7.1.2. DESIGN STANDARD

A.7.1.2.1. The following standards shall apply to the design of ball valves:

Table A.17 – Design Standards for ball valves

Description	Body / Closure Material							
	Casting or Forging				Forging			
	Flanged ^b				Socket weld ^c	Butt weld ^c	Flanged	
DN ^a (NPS)	50 up to 900 (2 up to 36)	50 up to 600 (2 up to 24)	50 up to 400 (2 up to 16)	50 up to 300 (2 up to 12)	15 up to 40 (1/2 up to 1 1/2)			
Class	150, 300 600	900	1500	2500	800	1500	2500	150, 300, 600 900, 1500, 2500
Standard	API 6D / IOGP S-562 ^d				ISO 17292	ASME B 16.34 LTD	API 6D	

^a DN = Nominal diameter, in millimeters (mm).

^b For DN > standard diameter, face to face shall be by agreement between manufacturer and PETROBRAS. The design shall be according ASME B16.34.

^c The design of the valve shall consider the use of a nipple with extension of 100,00 millimeters.

^d As applicable. See also A.7.1.8.

A.7.1.3. MOUNTING TYPE

A.7.1.3.1. The design of metallic ball valves (Metal to Metal or Soft seated) shall attend the following characteristic regarding mounting:

Table A.18 – Mounting type for ball valves

DN (NPS)	150 300	600 800 900	1500 2500
15 (1/2) up to 40 (1 1/2)	N/A	Floating	Trunnion
50 (2) up to 100 (4)	Floating	Trunnion	
150 (6) and above	Trunnion		

A.7.1.4. ISOLATION VALVE CONFIGURATION

A.7.1.4.1. SINGLE PISTON EFFECT (SPE) OR SELF-RELIEF (SR) SEAT:

A.7.1.4.1.1. A SPE/SR assembly seat provides sealing only when differential pressure is higher from outside of the

valve. When the SPE assembly seat faces higher differential pressure from inside of the valve (cavity), it occurs self-relieving.

A.7.1.4.1.2. A SPE/SR assembly seat may be provided on a metal to metal seat design or on a soft seated design.

A.7.1.4.1.3. Left side of Figure A.5 illustrates the sealing mechanism when pressure (or higher differential pressure) is applied from outside of the valve. The difference in the area (“D”) times the line pressure creates a piston effect force which pushes the seat against the ball surface resulting in a sealing between ball and seat.

A.7.1.4.1.4. Right side of Figure A.5 illustrates the relief mechanism when a higher differential pressure is applied from the cavity of the valve. When the pressure in the valve cavity reach certain pressure (so that the total force from cavity pressure that act on the seat is higher than the force causing by the upstream pressure), the trapped pressure will have enough force to push the seat and relief the valve cavity pressure.

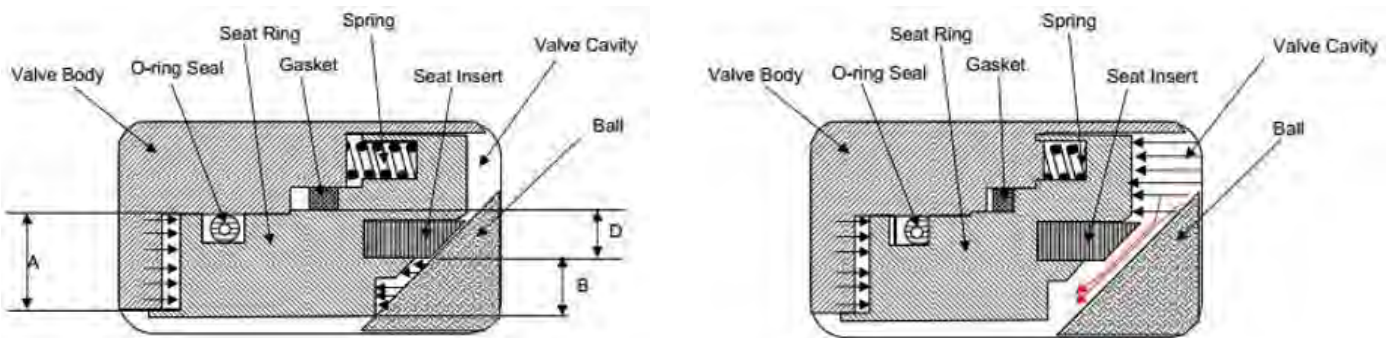

Figure A.5 – SPE/SR seat assembly mechanism (illustration on a soft ball valve)

A.7.1.4.2. DOUBLE PISTON EFFECT (DPE) SEAT:

A.7.1.4.2.1. A DPE assembly seat provides sealing on both directions, when differential pressure is higher from outside/inside of the valve.

A.7.1.4.2.2. A DPE assembly seat may be provided on a metal to metal seat design or on a soft seated design.

A.7.1.4.2.3. Left side of Figure A.6 illustrates the sealing mechanism when pressure (or higher differential pressure) is applied from outside of the valve. The difference in the area (“D”) times the line pressure creates a piston effect force which pushes the seat against the ball surface resulting in a sealing between ball and seat.

A.7.1.4.2.4. Right side of Figure A.6 illustrates the sealing mechanism when pressure (or differential pressure) is applied from the cavity of the valve. The difference in the area (“D”) times the cavity pressure creates a piston effect force which pushes the seat against the ball surface resulting in a sealing between ball and seat.

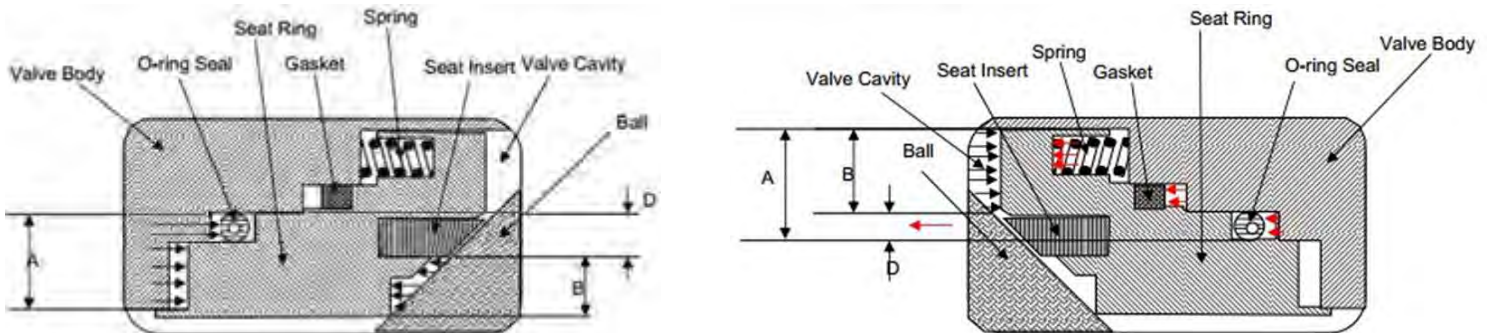

Figure A.6 – DPE seat assembly mechanism (illustration on a soft ball valve)

A.7.1.4.3. Whenever not specified in the VDS, the valve design shall consider as a standard isolation valve configuration

the use of two unidirectional sealing seats, giving a characteristic of single piston effect (SPE) or self-relief (SR) on both seats.

A.7.1.4.4. In order to ensure adequate operational requirements, whenever specified in the VDS, the design of trunnion ball valves (Metal to Metal or Soft seated) may attend one or more of the following functions/features:

a) DOUBLE BLOCK AND BLEED (DBB):

The DBB feature of the valve is the ability to segregate two pressure sources and to bleed/vent pressure in the valve body between the two seats when the valve has the DBB feature. The DBB feature may be obtained by using SPE/SR or DPE seats.

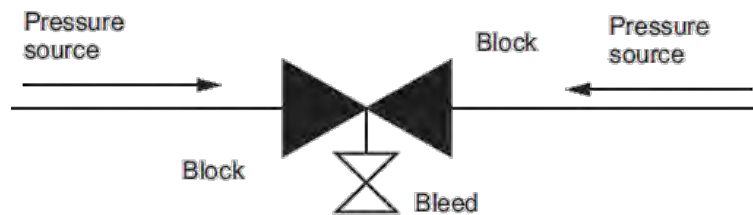

Figure A.7 – DBB feature (ref.: Double Block and Bleed - Type B of API 6D)

b) DOUBLE ISOLATION AND BLEED 1 (DIB-1):

The DIB-1 feature of the valve is the ability to provide two sealing elements to a single pressure source, and to bleed/vent between the two sealing elements. It shall be considered Upstream and Downstream as bidirectional sealing seat (DPE seats).

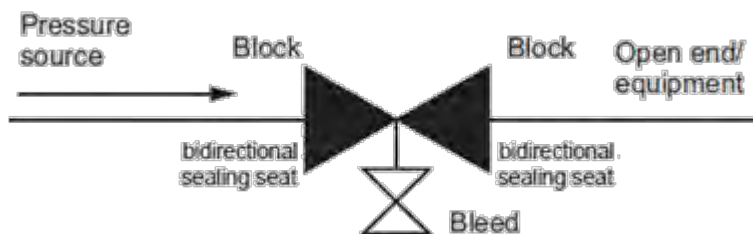

Figure A.8 – DIB-1 feature (ref.: Double Isolation and Bleed - Type B of API 6D)

Valves designed with a DIB-1 feature shall be provided with automatic cavity-pressure relief, unless otherwise agreed. In this case, it shall be attended all requirements described on API 6D (ref. item 5.8 of API6D).

c) DOUBLE ISOLATION AND BLEED 2 (DIB-2):

The DIB-2 feature of the valve is the ability to provide two sealing elements to a single pressure source, and to bleed/vent between the two sealing elements. It shall be considered the Upstream as unidirectional sealing seat (SPE seat) and downstream as bidirectional sealing seat (DPE seat).

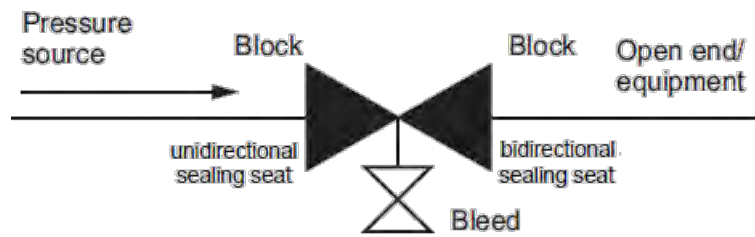

Figure A.9 – DIB-2 feature (ref.: Double Isolation and Bleed - Type B of API 6D)

All DIB-2 valves shall have a clear identification about seat sealing direction, by marking on a separate identification plate affixed to valve body both seats type of sealing (SPE or DPE).

The assembly of a DIB-2 valve on the line shall attend its preferred direction.

A.7.1.4.5. Depending on detailed design, indicated in the VDS, the valve may have an isolation valve configuration as follows:

Table A.19 – Isolation Valve Configuration for Ball Valves

Isolation valve configuration	Single Piston Effect (SPE) on both seats	Double Block and Bleed (DBB) Feature	Double Isolation and Bleed (DIB-2) Feature
1	Yes	No	No
2	Yes	Yes	No
3	No	Yes ¹	Yes
4	No	Yes ²	Yes

¹ DBB feature applied in the closed position (only).
² DBB feature applied in the opened and closed position (both).
 Note: The use of DIB-1 feature has not been foreseen. Particular analyses of use may be conducted by Project team and/or an Operational Unit (UO).

A.7.1.5. NON-METALLIC SEALS

A.7.1.5.1. All non-metallic seals shall be suitable for the pressure, temperature and service conditions considered in this item.

A.7.1.5.2. The manufacturer of the valve shall guarantee together with your seals supplier(s) the attendance of the essential material requirements for the non-metallic seals, in order to ensure that the designed seal system works properly during the whole design life of the valve.

A.7.1.5.3. The VDS of soft seated ball valves indicates the material of the seat insert.

A.7.1.5.4. The use of certain seat insert material shall be based on the following classification:

Table A.20 – Non-metallic materials for seat insert seal design

Material	Pressure Class	Design Temp. (°C)	
		Minimum	Maximum
PTFE reinforced with 25% of Carbon	150, 300	-46	+150
Devlon V-API ¹	600, 900	-46	+120

PEEK Based ²	600, 900, 1500, 2500	-46	+150
¹ The use of Devlon V-API is not allowed on valves applied on AM (amine) systems.			
² The use of PEEK is acceptable for pressure class 2500 only up to 120°C.			

Note: The values listed in Table A.20 presents the limits of temperature that shall be applied in the valve design considering operational conditions of it.

A.7.1.5.5. For the design of the seats / stem seals, in Metal to Metal or Soft seated ball valves, the VDS contains indication about the non-metallic group material that shall be considered in the valve design.

A.7.1.5.6. The materials of each group are indicated in Table A.21, according the following classification:

- Group A – Terpolymer of VF2, HFP e TFE with fluor content of ~ 67 - 70% or HNBR with %ACN between 36 and 40%. E.g.: Viton B (DuPont), Technoflon TN (Solvay Solexis);
- Group B – Ter- or Tetrapolymer of TFE, VF2 and PMVE with fluor content of ~ 62-68% or HNBR LT (%ACN between 36 and 40%) both with TR10 ≤ -30°C according ASTM D1329. E.g.: Viton GLT (DuPont), Technoflon 855 (Solvay Solexis);
- Group C – Terpolymer of PP, TFE and VDF with higher resistance to bases or perfluoro elastomer (FFKM). e.g.: FKM Type 4- Aflas (Asashi Glass), BRE 7132 (Dyneon), FFKM- Kalrez, Chemraz, Technoflon PFR (Solvay Solexis);
- Group D – Terpolymer of PP, TFE and VDF with higher resistance to aromatic hydrocarbons or perfluoro elastomer (FFKM). e.g.: BRE 7132 (Dyneon), FFKM- Kalrez, Chemraz, Technoflon PFR (Solvay Solexis);
- Group E – Polytetrafluoroethylene (PTFE) based Chevron Packing or Polytetrafluoroethylene (PTFE) energized with a Co-Cr-Ni alloy UNS R30003 (Elgiloy) spring;
- Group F – Graphite 98% pure, Graphoil or a metallic seal.

Table A.21 – Seal groups materials

Seals Group	Application	Design Temp. ¹		Transient Temp. ²		Seals Materials	Seals Design	RGD	Suitable for	Group Restrictions
		Min. (°C)	Max. (°C)	Min. (°C)	Max. (°C)					
Group A	Normal Temperature	0	+150	0	+170	HNBR FKM Type 2	O-ring Polypak Gasket	No	Water, Utility, Sweet hydrocarbon and Chemicals	Amines Steam Aromatic hydrocarbons ⁴
Group B	Low Temperature	-30	+150	-46	+170	HNBR LT FKM Type 3	O-ring Polypak Gasket	Yes ³	Sweet hydrocarbon (Gas)	Amines, Steam, Aromatic hydrocarbons ⁴
Group C	Medium High Temperature	0	+210	0	+240	FKM Type 4 FKM Type 5 FFKM	O-ring Polypak Gasket	No	Amines, Amine based scavengers and Inhibitors, Steam	Aromatic hydrocarbons ⁴ , Xylene
Group D	Medium High Temperature + Aromatics	0	+210	0	+240	FKM Type 5 FFKM	O-ring Polypak Gasket	No	All	-

Group E⁵	Wide Range Service	-100	+200	-100	+240	PTFE based PTFE based + UNS R30003 (Elgiloy)	Chevron Seal ⁶ Lip Seal	N/A	All	-
Group F	High Temperature	-100	+500	-100	+500	Graphite 98% Pure Graphoil Metallic Seal	Gasket C-Ring	N/A	All	-

¹ Temperature range for use of non-metallic material (i.e.: seats / stem seals) in the valve design. It shall be considered for continuous service without reducing the seals' economic life or its sealing capability.

² Temperature range considered whether the seals may be exposed for a short period of time (transient temperature spike), under a static condition (without operation), with a possible leakage but without permanently damaging the sealing system.

³ RGD according ISO 23936-2 for valves of pressure class 300 or above.

⁴ Hydrocarbons streams containing more than 25% aromatics.

⁵ The use of Group E is acceptable in replacement of Groups A, B, C or D, as long as the design of the valve considers application of Inconel 625 overlay (partial clad) on all sealing areas.

⁶ Use of Chevron packing shall be combined with anti-extrusion PEEK rings.

A.7.1.5.7. As a reference, the use of each group seal are based to the following fluid classes & temperature ranges:

Table A.22 – Indication of groups of seals according fluid class and temperature range

Fluid Class	Temperature Range				
	Normal (0°C to +150°C)	Low (-30°C to +150°C)	Medium High (0°C to +210°C)	Wide Range (-100°C to +200°C)	High (-100°C to +500°C)
Utility	Group A	-	-	-	-
Water	Group A	-	-	-	-
Hot Water	-	-	Group C	-	-
Steam	Group C	-	Group C	-	-
Sweet Hydrocarbon ¹	Group A	Group B	Group C	-	-
Sour Hydrocarbon ²	Group C	Group E	Group C	Group E	Group F
Aromatic Hydrocarbon ³	Group D	Group E	Group D	Group E	Group F
Chemicals ⁴	Group A	-	Group C	-	-
High CO ₂ content ⁵	-	-	-	Group E	-
Amine (MEA) ⁶	Group C	-	Group C	-	-

¹ Hydrocarbon streams containing less than 1% H₂S (10.000 ppm).

² Hydrocarbon streams containing more than 1% H₂S (10.000 ppm).

³ Hydrocarbons streams containing more than 25% aromatics.

⁴ It shall be considered the use of Group A for all chemicals typically used in a production facility (e.g.: inhibitors, scavengers, etc.), and Group D for amine based chemicals or xylene.

⁵ Hydrocarbon streams containing CO₂ with more than 10 mol%.

⁶ Monoethanolamine.

A.7.1.5.8. For the indication of a valve configuration, it shall be considered the following classification as a part of the valve code, according description of valve code presented on item A.11.5:

Table A.23 – Seals group classification into valve code

Seals Group	Soft	Metal x Metal
A or B	1	5
C	2	6
D or E	3	7
F	N/A	8
Fugitive Emissions	4	9

A.7.1.6. TYPICAL CONFIGURATIONS

A.7.1.6.1. This item presents typical configurations for ball valves, as a result of combinations of materials and features. The configurations herein listed are considered to create a specific VDS.

A.7.1.6.2. The referred number of the typical configuration of the valve, shown on the first column of Table A.25 and Table A.26, shall be considered as a part of the valve code, according item A.11.5.

A.7.1.6.3. BALL VALVES UP TO NPS 1 1/2 (“FORGED” VALVES)

A.7.1.6.3.1. The design of ball valves up to NPS 1 1/2 (“Forged” valves) shall consider the use of a nipple with extension of 100,00 millimeters.

A.7.1.6.3.2. For the indication of the nipple considered in the valve configuration, it shall be considered the following classification as a part of the valve code, according description of valve code presented on item A.11.5.

Table A.24 – Nipple classification into valve code

SCH	Pressure Class		
	800 ¹	1500	2500
40S	801	1501	2501
80	802	1502	2502
160	803	1503	2503
XXS	804	1504	2504

¹ Code 800 is used for screwed ended connections.

A.7.1.6.3.3. The following basic configurations shall be considered in the design of ball valves up to NPS 1 1/2 (“Forged” valves):

Table A.25 – Typical configurations for ball valves up to NPS 1 1/2 (“Forged” Valves)

Config. #	Sealing Type	Pressure Class	Seat Insert Material	Stem Seal Material	Fire Tested	End Connection	Seats Configuration	DBB	VSL
00	Soft	150, 300	PTFE + 25%C	Group A	Yes	Flanged	N/A	No	1, 2
		600, 900	Devlon V-API						
		1500, 2500	PEEK				SPE x SPE		
01	Soft	800	PTFE + 25%C	Group A, B	Yes	SW, SE	N/A	No	1, 2, 3
02			PTFE + 25%C	Group C, E					
03			Devlon V-API	Group A, B					
04			PEEK	Group C, E					
05	Metal to Metal		N/A	Group D, E					
06	Soft	1500	PEEK	Group A, B	Yes	SW	SPE x SPE	No	1, 2, 3
07	Metal to Metal		N/A	Group D, E					
08	Soft	2500	PEEK	Group A, B	Yes	BW	SPE x SPE	No	1, 2, 3
09	Metal to Metal		N/A	Group D, E					

A.7.1.6.4. BALL VALVES NPS 2 AND ABOVE

A.7.1.6.4.1. The following basic configurations shall be considered in the design of ball valves NPS 2 and above:

Table A.26 – Typical configurations for ball valves NPS 2 and above

Config. #	Sealing type	Seat Insert	Fire Tested	Pressure Class	Seats Configuration	DBB	VSL
0	Soft	PTFE+25%C	No	150, 300	SPE x SPE	No	1, 2
1			Yes				2
2		Devlon V-API	No	600, 900	SPE x SPE	No	1, 2
3			Yes				2
4		PEEK	No	600, 900 1500, 2500	SPE x SPE	Yes	1, 2
5			Yes				2
6		PTFE+25%C	No	150, 300	DIB-2	Yes	2, 3 ²
7			Yes				
8		PEEK	No	600, 900 1500, 2500	DIB-2	Yes	2, 3 ²
9			Yes				
0	Metal to Metal	N/A	No	150, 300, 600 900, 1500, 2500	SPE x SPE	No	1, 2
1			Yes				2
2			No	150, 300, 600 900, 1500, 2500	DIB-2	Yes	2, 3
3			Yes				
4			Yes	150, 300, 600 900, 1500, 2500	DIB-2	Yes ¹	4
5 ³			Yes	1500, 2500	DIB-2	Yes ¹	4

¹ DBB designed for fully opened and closed position. The valve shall be able to perform DBB test on both conditions.
² Soft seated ball valves with VSL-3 shall not be considered for use in hydrocarbon service lines.
³ Valve configuration used for HIPPS application.

A.7.1.6.5. RISING STEM BALL VALVES

A.7.1.6.5.1. The following basic configuration shall be considered in the design of rising stem ball valves:

Table A.27 – Typical configurations for rising stem ball valves

Config. #	Sealing type	Seat Insert	Fire Tested	Pressure Class	VSL
9	Metal to Metal	N/A	Yes	600,900	2,3

A.7.1.6.6. DOUBLE BALL VALVES

Table A.28 – Typical configurations for double ball valves

Config. #	Sealing type	Seat Seat Insert	Pressure Class	Stem Seal Material	Fire Tested	End Connection	VSL	
01	Soft	PTFE+25%C	150, 300	Group B	Yes	Flanged	2	
		PEEK	600, 900, 1500, 2500					
02		PTFE+25%C	150, 300			Flanged x NPT		
		PEEK	600, 900, 1500, 2500					
03		Metal to Metal	PTFE+25%C	150, 300		Group E		Flanged
			PEEK	600, 900, 1500, 2500				
04			PTFE+25%C	150, 300				Flanged x NPT
			PEEK	600, 900, 1500, 2500				
05	N/A		150, 300, 600 900, 1500, 2500	Group E	Flanged			
06					Flanged x NPT			
07		Group F		Flanged				
08				Flanged x NPT				

A.7.1.7. MATERIALS CONFIGURATIONS

A.7.1.7.1. STEM MATERIALS

A.7.1.7.1.1. Table A.29 presents the standardized materials for each combination of material and pressure class of the valve. The stem materials listed herein are considered to create a specific VDS.

A.7.1.7.1.2. Alternative materials are presented when applicable. The use of it shall be approved by PETROBRAS.

Table A.29 - Stem materials according material class & pressure class of the valve

(See next page)

Table A.29 - Stem materials according material class & pressure class of the valve

Material Class	Pressure Class							Alternate Material
	150	300	600	800	900	1500	2500	
Carbon Steel	ASTM A276 or A479 (UNS S41000)							ASTM A564 Type 630 (UNS S17400) ASTM A276 (UNS S31803) ASTM A276 (UNS S32760) ASTM B637 (UNS N07718)

Material Class	Pressure Class						Alternate Material
	150	300	600	800	900	1500	
Low Temperature Carbon Steel	ASTM A276 (UNS S31600)				ASTM A564 Type 630 H1150 (UNS S17400)		ASTM A564 Type 630 H1150 (UNS S17400) ASTM A276 (UNS S31803) ASTM A276 (UNS S32760) ASTM B637 (UNS N07718)
Carbon Steel with Organic Coating (Onshore / Offshore)	ASTM A276 or A479 (UNS S31803)						ASTM A276 (UNS S31803) ASTM A276 (UNS S32760) ASTM B637 (UNS N07718)
Carbon Steel with Inconel 625 overlay (UNS N06625)	ASTM B637 (UNS N07718)						N/A
Stainless Steel	ASTM A276 or A479 (UNS S31600)				ASTM A564 Type 630 H1150 (UNS S17400) ¹		ASTM A564 Type 630 H1150 (UNS S17400) ASTM B637 (UNS N07718)
Duplex Steel	ASTM A276 or A479 (UNS S31803)						ASTM A276 (UNS S32760) ASTM B637 (UNS N07718) Hastelloy C276 (UNS N10276)
Super Duplex Steel	ASTM A276 or A479 (UNS S32760)						ASTM B637 (UNS N07718) Hastelloy C276 (UNS N10276)
Alloy Steel (ASTM A333 Gr.3)	ASTM B637 (UNS N07718)						N/A
Alloy Steel (ASTM A333 Gr.8)	ASTM B637 (UNS N07718)						N/A

¹ Whenever Group E is considered as seats / stem seals material in metal to metal ball valves (due to low temperature requirements), it shall be used ASTM B637 (UNS N07718).

A.7.1.7.2. SPRING MATERIAL

A.7.1.7.2.1. All valves design shall consider the use of Inconel X750 (UNS N07750) as spring material, to be used on the seat assembly.

A.7.1.7.3. METALLIC COATING

A.7.1.7.3.1. Whenever specified in the VDS use of partial clad, it shall be considered the application according:

Table A.30 – Specification of metallic coating (partial clad) for ball valves

Partial Clad	
Stainless Steel (AISI 316) Weld Overlay	Valves with VSL = 2 which Material Class is Carbon Steel or Low Temperature Carbon Steel
Nickel Alloy (Inconel 625) Weld Overlay	Valves with VSL ≥ 3 and all valves with seals (seats/stem) using Group E. Note: Only applicable for valves with Material Classes Carbon Steel, Low Temperature Carbon Steel or Stainless Steel

A.7.1.7.3.2. Whenever specified in the VDS partial clad, it shall be considered the application of CRA (according Table A.30) on all body sealing areas.

A.7.1.7.3.3. Whenever specified in the VDS full clad, it shall be considered the application of Nickel Alloy (Inconel 625) Weld Overlay on all wetted parts.

A.7.1.7.3.4. All metallic coatings shall attend the specific requirements listed in item A.8.2.1.

A.7.1.7.4. HARD COATING

A.7.1.7.4.1. All designs of soft ball valves shall consider the application of hard coating on seats / ball according:

Table A.31 – Specification of hard coating on seats / ball on soft ball valves

VSL	Pressure Class						
	150	300	600	900	1500	2500	10000
VSL-1	N/A						
VSL-2	N/A				Tungsten Carbide or Chrome Carbide		
VSL-3	N/A		Tungsten Carbide or Chrome Carbide				
VSL-4	N/A						

A.7.1.7.4.2. All designs of metal to metal ball valves shall consider the use of hard coating on seats / ball according:

Table A.32 – Specification of hard coating on seats / ball on metal to metal ball valves

(See next page)

Table A.32 – Specification of hard coating on seats / ball on metal to metal ball valves

VSL	Pressure Class						
	150	300	600	900	1500	2500	10000
VSL-1	Chromium Electroplate ¹		Tungsten Carbide ² or Chrome Carbide				
VSL-2							

VSL-3	Tungsten Carbide ² , Chrome Carbide ² or Chrome-Nickel Spray and Fuse
VSL-4	
¹ If requested by the manufacturer, it may be acceptable the use of tungsten carbide or chrome carbide coating. ² For valves which maximum design temperature is above 210°C, it only shall be considered application of chrome-nickel Spray and Fuse coating.	

A.7.1.7.4.3. All hard coatings application shall attend the specific requirements listed in item A.8.2.2.

A.7.1.7.5. SOFT SEATED BALL VALVES

Table A.33 – Typical configurations for soft seated ball valves according material class

Material Class	Pressure Class	Seat Insert Material	Body Material ²	Ball / Seats Material ³
Carbon Steel	150 300	PTFE + 25%C	ASTM A105 or ASTM A216 WCB + Partial Clad ¹	AISI 410
	600 800 900	Devlon V-API		AISI 410
		PEEK		AISI 410 + Hard Coating ³
	1500 2500	PEEK		AISI 410 + Hard Coating ³
Low Temperature Carbon Steel	150 300	PTFE + 25%C	ASTM A350 LF2 Cl1 or ASTM A352 Gr.LCB + Partial Clad ¹	AISI 316
	600 800 900	Devlon V-API		AISI 316
		PEEK		AISI 316 + Hard Coating ³
	1500 2500	PEEK		AISI 316 + Hard Coating ³
Carbon Steel with Organic Coating (Onshore)	150 300	PTFE + 25%C	ASTM A105 or ASTM A216 WCB	ASTM A995 Gr.1b
	600 900	Devlon V-API		ASTM A995 Gr.1b

Material Class	Pressure Class	Seat Insert Material	Body Material ²	Ball / Seats Material ³
Carbon Steel with Organic Coating (Offshore)	150 300	PTFE + 25%C	ASTM A105 or ASTM A216 WCB	UNS S31803
	600 900	Devlon V-API		UNS S31803

	1500	PEEK		UNS S31803 + Hard Coating ³
Stainless Steel	150 300	PTFE + 25%C	ASTM A182 Gr. F316 or ASTM A351 Gr. CF8M + Partial Clad ¹	AISI 316
	600 800 900	Devlon V-API		AISI 316
		PEEK		AISI 316 + Hard Coating ³
	1500 2500	PEEK		AISI 316 + Hard Coating ³
Duplex Steel	150 300	PTFE + 25%C	ASTM A182 Gr. F51 or ASTM A995 Gr. 4a or ASTM A995 Gr. 1b (onshore only)	UNS S31803
	600 800 900	Devlon V-API		UNS S31803
		PEEK		UNS S31803 + Hard Coating ³
	1500 2500	PEEK		UNS S31803 + Hard Coating ³
Super Duplex Steel	150 300	PTFE + 25%C	ASTM A182 Gr. F55 or ASTM A995 Gr 6a	UNS S32760
	600 800 900	Devlon V-API		UNS S32760
		PEEK		UNS S32760 + Hard Coating ³
	1500 2500	PEEK		UNS S32760 + Hard Coating ³
Alloy Steel (ASTM A333 Gr.3)	600 800 900	PEEK	ASTM A350 Gr. LF3 or ASTM A352 Gr. LF3	UNS N06625 + Hard Coating ³
Alloy Steel (ASTM A333 Gr.8)	2500	PEEK	ASTM A522 Type I	ASTM A522 Type I + Hard Coating ³

¹ Partial clad may be requested in the VDS, and shall be according Table A.30.
² The use of forging or casting shall be according VSL classification. For valves with NPS < 2, It shall be considered only the use of forging material.
³ Hard Coatings may be requested in the VDS, and shall be applied according Table A.31.

A.7.1.7.6. METAL SEATED BALL VALVES

Table A.34 – Typical configurations for metal to metal seated ball valves according material class

Material Class	Pressure Class	Body Material ^{1, 2}	Ball / Seats Material ³
Carbon Steel		ASTM A105 or ASTM A216 WCB + Partial Clad ¹	AISI 410 + Hard Coating ³
Low Temperature Carbon Steel	150 300 600	ASTM A350 LF2 Cl1 or ASTM A352 Gr.LCB + Partial Clad ¹	AISI 316 + Hard Coating ³
Stainless Steel	800 900 1500 2500 10000psi	ASTM A182 Gr. F316L or ASTM A351 Gr. CF8M + Partial Clad ¹	AISI 316 + Hard Coating ³
Duplex Steel		ASTM A182 Gr. F51 or ASTM A995 Gr 4A	UNS S31803 + Hard Coating ³
Super Duplex Steel		ASTM A182 Gr. F55 or ASTM A995 Gr 6A	UNS S32760 + Hard Coating ³
Alloy Steel (ASTM A333 Gr.3)	600 800 900	ASTM A350 Gr. LF3 or ASTM A352 Gr. LF3	UNS N06625 + Hard Coating ³
Alloy Steel (ASTM A333 Gr.8)	2500 10000psi	ASTM A522 Type I	ASTM A522 Type I + Hard Coating ³
¹ Partial clad may be requested in the VDS, and shall be according Table A.30. ² The use of forging or casting shall be according VSL classification. For valves with NPS < 2, It shall be considered only the use of forging material. ³ Hard Coatings may be requested in the VDS, and shall be applied according Table A.31.			

A.7.1.8. BALL VALVES ACCORDING TO IOGP S-562

A.7.1.8.1. Ball valves included in scope of S-562 shall comply with S-562, this Annex and following requirements/modifications.

A.7.1.8.2. Design validation shall be as required by Table A.3.

A.7.1.8.3. Process fabrication for body materials shall be according Table A.7.

A.7.1.8.4. Table J.3 of S-562, sequence 7, shall be read as: Low-pressure pneumatic seat test at 80 psi (6 bar) to 100

psi (7 bar) per H.3.2 Type I.

A.7.1.8.5. For fluid services such as aromatic hydrocarbons, steam, methanol, amines, strong alkalis and some Freons, Table A.21 and Table A.22 shall be used as reference to selection of suitable sealing material.

A.7.1.8.6. For classes 150 to 600, all sizes, and for classes 900 to 2500, sizes NPS 8 (DN 200), vents and drains shall have double seal (axial outboard and radial inboard) parallel threads with locking ring. During loosening of the fitting, the design configuration shall ensure pressure is relieved from the inboard seal without thread disengagement.

A.7.1.8.7. NDE, tests and documentation of each valve shall be according A.7.1.8.7.1 to A.7.1.8.7.4.

A.7.1.8.7.1. VSL-1 valves shall comply with S-562 QSL-1 requirements.

A.7.1.8.7.2. VSL-2 valves shall comply with S-562 QSL-2 requirements.

A.7.1.8.7.3. VSL-3 valves shall comply with S-562 QSL-3 requirements.

A.7.1.8.7.4. VSL-4 valves shall comply with S-562 QSL-4 requirements.

A.7.1.8.8. SDV, BDV, XV and ADV valves shall be fire tested. For other valves, fire type-tested certified design shall be required according design premises.

A.7.2. GATE VALVE

A.7.2.1. DESIGN REQUIREMENTS

A.7.2.1.1. It shall be considered a Metal to Metal seated design for all types of gate valve. Expanding gate valves may have an additional non-metallic insert.

A.7.2.1.2. Whenever specified in the VDS, the manufacturer shall attend to the requirement of coating, such as metallic coating, hard coating and/or organic coating specified for some parts and sealing surfaces, such as in the body, bonnet, gate, seats, etc. In this case, the manufacturer shall attend the applicable requirements listed on item A.8.2.

A.7.2.1.3. Gate valves, with flanged or butt weld ends, shall have face to face dimensions according ASME B16.10.

A.7.2.1.4. End connections shall be according:

- a) Flanged ends: according ASME B16.5 up to DN 600 (NPS 24) for ASME classes 150 to 1500, and up to DN 300 (NPS 12) for class 2500; according ISO 27509 for DN 400 (NPS 14) to NPS 600 (NPS 24) in ASME class 2500; according ASME B16.47 Series A from DN 650 (NPS 26) up to DN 1500 (NPS 60) for ASME Classes 150 to 600, and and from DN 650 (NPS 26) up to DN 1200 (NPS 48) for ASME class 900.
- b) Screwed ends: according ASME B1.20.1 NPT;
- c) Butt weld: according ASME B16.25;
- d) Socket weld: according ASME B16.11

A.7.2.1.5. The gate skirts shall be designed to minimize seats wearing and maintain the alignment between gate and seats, for all valve position.

A.7.2.1.6. In case the design of a gate valve consider the use of drain and vent ports, the plugs shall be specified considering the alert given in item A.6.1.1.10.

A.7.2.1.7. Up to and including DN 40 (NPS 1 ½), the valve shall be furnished with a solid wedge.

A.7.2.2. DESIGN STANDARD

A.7.2.2.1. The following standards shall be considered for the design of gate valves:

Table A.35 – Design Standards for gate valves

Description	Body / Closure Material					
	Forging			Forging or Casting		
	Socket weld	Butt weld	Flange	Flange		
DN (NPS)	15 up to 40 (1/2 up to 1 1/2)	25 up to 40 (1 up to 1 1/2)	46 up to 346 (1 13/16 up to 13 5/8)	50 up to 600 (2 up to 42)	50 up to 400 (2 up to 24)	50 up to 300 (2 up to 12)
Class	800 and 1500	2500	10.000 psi	150 and 300	600 to 1500	2 500
Standard	API 602	ASME B16.34 LTD	API 6A	API 600 / IOGP S-611 ^a		

^a As applicable. See also A.7.2.5

A.7.2.3. NON-METALLIC SEALS

A.7.2.3.1. All non-metallic seals shall be suitable for the pressure, temperature and service conditions specified in the VDS.

A.7.2.3.2. The manufacturer of the valve shall guarantee together with your seals supplier(s) the necessary material requirements for the non-metallic seals, in order to ensure that the designed seal system works properly during the whole design life of the valve.

A.7.2.3.3. For solid wedge gate valves, the design shall consider the use of gaskets made of flexible graphite with inconel wire for the stem seal.

A.7.2.3.4. The design of a slab gate valve shall consider the use of non-metallic seals, mounted on seats and stem, according the materials specified in the VDS.

A.7.2.4. TYPICAL CONFIGURATIONS

A.7.2.4.1. This item presents typical configurations for gate valves, as a result of combinations of materials and features. The following configurations are considered to create a specific VDS.

A.7.2.4.2. The referred number of the typical configuration of a gate valve, shown on the first column of Table A.36, Table A.37 and Table A.38, shall be considered as a part of the valve code, according item A.11.5.

A.7.2.4.3. TRIM MATERIAL CONFIGURATION FOR SOLID WEDGE GATE VALVES

Table A.36 – TRIM material configuration for solid wedge gate valves

Material Class	Body Material	API 600 TRIM Number	Gate Material	Seat Material	Stem Material
Carbon Steel	ASTM A105 or ASTM A216 Gr. WCB	Trim Number 8 (API 600 / 602)	AISI 410	Stellite (Co-Cr Alloy)	ASTM A276 (UNS S41000)
	ASTM A105 or ASTM A216 Gr. WCB	Trim Number 5 (API 600 / 602)	Stellite (Co-Cr Alloy)	Stellite (Co-Cr Alloy)	ASTM A276 (UNS S41000)

Material Class	Body Material	API 600 TRIM Number	Gate Material	Seat Material	Stem Material
	ASTM A350 LF2 Cl 1 or ASTM A352 Gr. LCB	Trim Number 16 (API 600 / 602)	AISI 316	Stellite (Co-Cr Alloy)	ASTM A276 (UNS S31803)
	ASTM A105 or ASTM A216 Gr. WCB + Organic Coating	-	ASTM A995 Gr. 1b	ASTM A995 Gr. 1b	ASTM A276 (UNS S32550)
			ASTM A995 Gr. 4a	ASTM A995 Gr. 4a	ASTM A276 (UNS S31803)
Stainless Steel	ASTM A182 Gr. F316 or ASTM A351 Gr. CF8M	Trim Number 16 (API 600 / 602)	AISI 316	Stellite (Co-Cr Alloy)	A276 316 / 316L
Duplex Steel	ASTM A182 F51 or ASTM A995 Gr. 4a	-	UNS S31803	UNS S31803	ASTM A276 (UNS S31803)
	ASTM A182 F55 or ASTM A995 Gr. 6a	-	UNS S32760	UNS S32760	ASTM A276 (UNS S32760)
Nickel Alloy	ASTM B564 (UNS N06625)	-	ASTM B564 (UNS N06625)	ASTM B564 (UNS N06625)	ASTM B637 (UNS N07718)
Uncommon Materials	Bronze ASTM B61 (UNS C92200)	-	ASTM B61 (UNS C92200)	ASTM B61 (UNS C92200)	ASTM B61 (UNS C92200)
	Gray Iron ASTM A126 Cl. B	-	ASTM B62 (UNS C83600)	ASTM B62 (UNS C83600)	ASTM B62 (UNS C83600)
	Nickel Aluminum Bronze ASTM B148 (UNS C95800)	-	ASTM B148 (UNS C95800)	ASTM B148 (UNS C95800)	ASTM B150 (UNS C63200)

A.7.2.4.4. OBTURATOR TYPE

Table A.37 – Obturator type for gate valves

Obturator type	
0	Solid wedge
1	Slab gate
2	Expanding gate

A.7.2.4.5. TRIM DESIGN

Table A.38 – TRIM selection

TRIM design	
1	Standard TRIM
2	Alternative TRIM

3	Special TRIM
----------	--------------

A.7.2.5. GATE VALVES ACCORDING TO IOGP S-611

- A.7.2.4.6. Gate valves included in scope of S-611 shall comply with S-611 and following requirements/modifications.
- A.7.2.4.7. Design validation shall be as required by Table A.3.
- A.7.2.4.8. Process fabrication for body materials shall be according Table A.7.
- A.7.2.4.9. First paragraph of S-611 item H.3.5 shall be read as: Valves shall be tested with full pressure end thrust effect to check the effectiveness of body joints and tightness as per Table H.5. Test shall be carried out with horizontal flow bore and stem horizontal to demonstrate compliance with 5.6.3/5.6.5 (API 600/API 603). For this selected valve from Table H.5, functional test in accordance with H 3.6.2, except step (a) (2), shall be carried out over five cycles.
- A.7.2.4.10. NDE, tests and documentation of each valve shall be according A.7.2.4.10.1 to A.7.2.4.10.4.
 - A.7.2.4.10.1. VSL-1 valves shall comply with S-611 QSL-1 requirements.
 - A.7.2.4.10.2. VSL-2 valves shall comply with S-611 QSL-2 requirements.
 - A.7.2.4.10.3. VSL-3 valves shall comply with S-611 QSL-3 requirements.
 - A.7.2.4.10.4. VSL-4 valves shall comply with S-611 QSL-4 requirements.

A.7.3. CHECK VALVE

A.7.3.1. DESIGN REQUIREMENTS

- A.7.3.1.1. Check valves, with flanged or butt weld ends, shall have face to face dimensions according ASME B16.10.
- A.7.3.1.2. End connections shall be according:
 - a) Flanged ends: according ASME B16.5 up to DN 600 (NPS 24) for ASME classes 150 to 1500, and up to DN 300 (NPS 12) for class 2500; according ASME B16.47 Series A from DN 650 (NPS 26) up to DN 1500 (NPS 60) for ASME Classes 150 to 600, and and from DN 650 (NPS 26) up to DN 1200 (NPS 48) for ASME class 900.
 - b) Screwed ends: according ASME B1.20.1 NPT;
 - c) Butt weld: according ASME B16.25;
 - d) Socket weld: according ASME B16.11
- A.7.3.1.3. For others materials not specified in the VDS, such as bolts, nuts, washers and lock pins, it shall be considered the use of materials with similar corrosion resistance than the materials indicated for the internals.
- A.7.3.1.4. Whenever specified in the VDS, the manufacturer shall attend to the coating, such as metallic coating, hard coating and/or organic coating specified for some parts and sealing surfaces. In this case, the manufacturer shall attend the applicable requirements listed on item A.8.2.
- A.7.3.1.5. In case the design of a check valve consider the use of drain and vent ports, the plugs shall be specified considering the alert given in item A.6.1.1.10.

A.7.3.2. DESIGN STANDARD

- A.7.3.2.1. The following standards shall apply to the design of check valves:

Table A.39 – Design Standards for check valves

Description	Body / Closure Material							
	Casting	Forging	Forging	Forging or Casting				Forging
	Flanged or Screwed End	Flanged or Socket weld	Butt welding	Flanged, wafer and lug				Flanged
DN (NPS)	15 up to 40 (1/2 up to 1 1/2)	15 up to 40 (1/2 up to 1 1/2)	25 up to 40 (1 up to 1 1/2)	50 up to 1200 (2 up to 48)	50 up to 1050 (2 up to 42)	50 up to 600 (2 up to 24)	50 up to 300 (2 up to 12)	50 up to 254 (2 up to 10)
Class	150, 200	800 and 1500	2500	150 and 300	600	900 and 1500	2500	10.000 psi
Standard	MSS SP-80	API 602	ASME B16.34 LTD	API 594, API 6D				API 6A

A.7.3.3. NON-METALLIC SEALS

A.7.3.3.1. For the design of soft seated dual plate check valve, the VDS contains indication about the non-metallic group material that shall be considered in the valve design, in this case:

- Group A – Terpolymer of VF2, HFP e TFE with fluor content of ~ 67 - 70% or HNBR with %ACN between 36 and 40%. E.g.: Viton B (DuPont), Technoflon TN (Solvay Solexis);

Table A.40 – Seal group materials for soft seated dual plate check valve

Seals Group	Application	Operating Temp. ¹		Design Temp. ²		Seals Materials	Seals Design	RGD	Suitable for	Group Restrictions
		Min. (°C)	Max. (°C)	Min. (°C)	Max. (°C)					
Group A	Normal Temperature	0	+150	0	+170	HNBR FKM Type 2	O-ring Polypak Gasket	No	Water, Utility, Sweet hydrocarbon and Chemicals	Amines, Steam, Aromatic hydrocarbons ³

¹ Temperature range considered for continuous service without reducing the seals' economic life or its sealing capability.
² Temperature range considered whether the seals may be exposed for a short period of time (transient temperature spike), under a static condition (without operation), with a possible leakage but without permanently damaging the sealing system.
³ Hydrocarbons streams containing more than 25% aromatics.

A.7.3.4. TYPICAL CONFIGURATIONS

A.7.3.4.1. This item presents typical configurations for check valves, as a result of combinations of materials and features. The following configurations are considered to create a specific VDS.

A.7.3.4.2. The referred number of the typical configuration of a check valve, shown on the first column of Table A.41, Table A.42 and Table A.43, shall be considered as a part of the valve code, according item A.11.5.

A.7.3.4.3. TRIM MATERIAL ACCORDING MATERIAL CLASS

Table A.41 – TRIM material according material class

Material Class	Body Material	Soft Sealing	Metal to Metal Sealing	
		Primary TRIM	Primary TRIM ¹	Secondary TRIM ²
Carbon Steel	ASTM A105	Trim Number 1	Trim Number 8	Trim Number 5

Material Class	Body Material	Soft Sealing	Metal to Metal Sealing	
		Primary TRIM	Primary TRIM ¹	Secondary TRIM ²
	or ASTM A216 WCB	(API 594)	(API 594)	(API 594)
Low Temperature Carbon Steel	ASTM A350 LF2 Cl.1 or ASTM A352 LCB	Trim Number 10 (API 594)	Trim Number 12 (API 594)	N/A
Stainless Steel	ASTM A182 F316 or ASTM A351 CF8M	Trim Number 10 (API 594)	Trim Number 12 (API 594)	N/A
Duplex Steel (Onshore)	ASTM A995 Gr. 1b	ASTM A995 Gr. 1b	N/A	N/A
Duplex Steel (Offshore)	ASTM A182 F51 or ASTM A995 Gr. 4a	ASTM A182 F51 or ASTM A995 Gr. 4a	ASTM A182 F51 or ASTM A995 Gr. 4a	N/A
Superduplex Steel	ASTM A182 F55 or ASTM A995 Gr. 6a	ASTM A182 F55 or ASTM A995 Gr. 6a	ASTM A182 F55 or ASTM A995 Gr. 6a	N/A
Alloy Steel (ASTM A333 Gr.3)	ASTM A350 LF3 or ASTM A352 LF3 + Inconel 625 (UNS N06625)	N/A	ASTM A350 LF3 + Inconel 625 (UNS N06625)	N/A
Alloy Steel (ASTM A333 Gr.8)	ASTM A522 Type I	N/A	ASTM A522 Type I	N/A
Alloy Steel (ASTM A333 Gr.8) with Inconel cladding	ASTM A522 Type I + Inconel 625 (UNS N06625)	N/A	ASTM A522 Type I + Inconel 625 (UNS N06625)	N/A
Nickel Aluminum Bronze	ASTM B148 (UNS C95800)	ASTM B148 (UNS C95800)	N/A	N/A
Gray Iron	ASTM A126 Cl B	TRIM AA (API 594)	N/A	N/A

A.7.3.4.4. OBTURATOR TYPE

Table A.42 – Obturator type for check valves

Config. #	Type
0	Piston
1	Dual plate
2	Swing
3	Axial non-slam
4	Ball

A.7.3.4.5. TRIM SELECTION

Table A.43 – TRIM selection

Config. #	Type	Body Construction
1	Primary TRIM (Soft)	Wafer
2	Primary TRIM (Metal x Metal)	Wafer
3	Secondary TRIM (Metal x Metal)	Wafer
4	Alternative TRIM	Wafer
5	Primary TRIM (Metal x Metal)	Double Flanged Short Pattern

A.7.4. GLOBE VALVE

A.7.4.1. DESIGN REQUIREMENTS

A.7.4.1.1. It shall be considered a Metal to Metal seated design for all types of globe valve.

A.7.4.1.2. Whenever specified in the VDS, the manufacturer shall attend to the requirement of coating, such as metallic coating, hard coating and/or organic coating specified for some parts and sealing surfaces, such as in the body, etc. In this case, the manufacturer shall attend the applicable requirements listed on item A.8.2.

A.7.4.1.3. Globe valves, with flanged or butt weld ends, shall have face to face dimensions according ASME B16.10.

A.7.4.1.4. End connections shall be according:

- a) Flanged ends: According ASME B16.5 up to DN 600 (NPS 24) for ASME classes 150, 300, 600 and 900, according ASME B16.47 Series A from DN 650 up to DN 1500 (NPS 26-60) for and from DN 650 up to DN 1200 (NPS 26-48) for ASME class 900.
- b) Screwed ends: according ASME B1.20.1 NPT;
- c) Butt weld: according ASME B16.25;
- d) Socket weld: according ASME B16.11

A.7.4.2. DESIGN STANDARD

A.7.4.2.1. The following standards shall apply to the design of globe valves:

Table A.44 – Design Standards for globe valves

Description	Body / Closure Material		
	Forging		Casting or Forging
	Socket Weld	Butt Weld	Flange
DN^a (NPS)	15 up to 40 (1/2 up to 1 1/2)	25 up to 40 (1 up to 1 1/2)	50 up to 400 (2 up to 16)
Class	800 and 1500	2500	150 up to 2500
Standard	API 602	ASME B16.34 LTD	BS 1873 or API 623

^a DN = Nominal diameter, in millimeters (mm).

A.7.4.3. TYPICAL CONFIGURATIONS

A.7.4.3.1. This item presents typical configurations for globe valves, as a result of combinations of materials and features. The following configurations are considered to create a specific VDS.

A.7.4.3.2. The referred number of the typical configuration of a globe valve, shown on the first column of Table A.45 and Table A.46, shall be considered as a part of the valve code, according item A.11.5.

A.7.4.3.3. TRIM MATERIAL CLASS CONFIGURATION

Table A.45 – TRIM material class configuration for globe valves

Material Class	Body Material	Metal to Metal Sealing	
		Primary TRIM ¹	Secondary TRIM
Carbon Steel	ASTM A105 or ASTM A216 WCB	CR13 and HF (BS 1873)	HF (BS 1873)
Carbon Steel with organic coating	ASTM A105 or ASTM A216 WCB	ASTM A995 Gr. 4a	ASTM A995 Gr 1b
Low Temperature Carbon Steel	ASTM A350 LF6 Cl.1 or ASTM A352 LCB	AISI 316 + Stellite	N/A
Stainless Steel	ASTM A182 F316L or ASTM A351 CF8M	AISI 316 + Stellite	N/A
Duplex Steel	ASTM A182 F51 or ASTM A995 Gr. 4a	ASTM A182 F51 or ASTM A995 Gr. 4a	N/A
Super duplex Steel	ASTM A182 F55 or ASTM A995 Gr. 6a	ASTM A182 F55 or ASTM A995 Gr. 6a	N/A
Alloy Steel (ASTM A333 Gr.3)	ASTM A350 LF3 or ASTM A352 LF3	ASTM A350 LF3	N/A
Alloy Steel (ASTM A333 Gr.8)	ASTM A522 Type I	ASTM A522 Type I	N/A
Nickel Aluminum Bronze	ASTM B148 (UNS C95800)	NAB (BS 1873)	N/A

A.7.4.3.4. OBTURATOR TYPE

Table A.46 – Obturator type for globe valves

Config. #	Type
0	Bevelled disc
1	Angular

A.7.5. BUTTERFLY VALVE

A.7.5.1. DESIGN REQUIREMENTS

A.7.5.1.1. It shall be considered the following types of butterfly valves: Category A (concentric), Category B (Double offset) and Category B (Triple Offset).

A.7.5.1.2. All butterfly valves category B with double offset shall consider a Soft seated design.

A.7.5.1.3. All butterfly valves category B with triple offset shall consider a Metal to Metal seated design.

A.7.5.1.4. Whenever specified in the VDS, the manufacturer shall attend to the requirement of coating, such as metallic coating and/or hard coating specified for some parts and sealing surfaces, such as in the body or disc. In this case, the manufacturer shall attend the applicable requirements listed on items A.7.5.4.3 and A.8.2.

A.7.5.2. DESIGN STANDARD

A.7.5.2.1. The following standards shall apply to the design of butterfly valves:

Table A.47 – Design Standards for butterfly valves

Description	Body / Closure Material					
	Category A	Category B				
	Concentric	Double offset			Triple offset	
	Wafer or Lug	Wafer or Lug	Flanged (Short Pattern)		Flanged (Short Pattern)	
	Ductile Iron	Forging or Casting			Forging or Casting	
DN^a (NPS)	50 to 1200 (2 to 48)	50 to 600 (3 to 24)	50 to 1200 (3 to 48)	50 to 600 (3 to 24)	50 to 1200 (2 to 48)	50 to 600 (2 to 24)
Class	Maximum Working Pressure (MWP)	150 up to 600	150 up to 300	600	150 up to 300	600
Standard	API 609					

^a DN = Nominal diameter, in millimeters (mm).

A.7.5.3. NON-METALLIC SEALS

A.7.5.3.1. For the design of seats / stem seals, in butterfly valves Category A or B, the following materials shall be considered:

Table A.48 – Non-metallic materials for seats / stem seal design

Type	Material	Minimum Temp. (°C)	Maximum Temp. (°C)
Category A	NBR	-10	+80
Category B (Double Offset)	RPTFE	-46	+260
Category B (Triple Offset)	Graphite	-240	+550

Note: Temperature values listed in Table A.48 represents the limits of use the non-metallic material on a butterfly valve design.

A.7.5.4. MATERIAL CONFIGURATION

A.7.5.4.1. CATEGORY B (TRIPLE OFFSET) CONFIGURATION

A.7.5.4.2. For the design of butterfly valves category B (triple offset), it may be considered one of the following configurations:

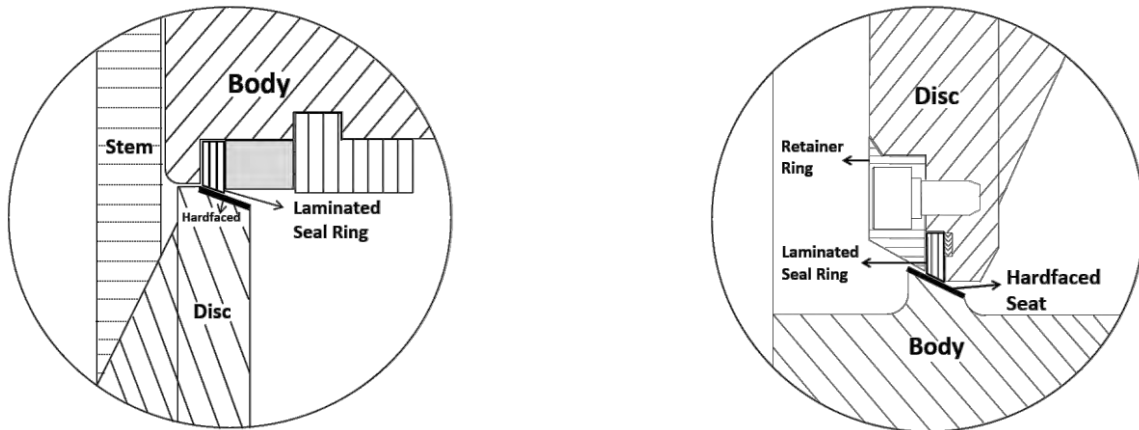

(a) Seal ring fixed to body & hard coating on disc

(b) Seal ring fixed to disc & hard coating on body

Figure A.10 – Illustration of typical category B (triple offset) seat configurations

A.7.5.4.3. METALLIC COATING

A.7.5.4.3.1. Whenever AISI 410 is considered as disc material for category B butterfly valves, it shall be applied ENP coating on disc sealing surface.

A.7.5.4.3.2. On triple offset butterfly valves (category B), it shall be applied metallic coating on sealing surface (disc or body, depending on configuration as described in Figure A.10). In this case, the use of Cobalt-Chromium (Co-Cr) weld overlay or ENP are acceptable.

A.7.5.4.3.3. All metallic coatings application shall attend the specific requirements listed in item A.8.2.1.

A.7.5.5. TYPICAL CONFIGURATIONS

A.7.5.5.1. MATERIAL CLASS CONFIGURATION

Table A.49 – Material class configuration for butterfly valves

(see next page)

Table A.49 – Material class configuration for butterfly valves

Material Class	Body Material	Type	Disc Material	Seats ¹	Stem	Seal Ring
Carbon Steel	ASTM A105 or ASTM A216 Gr. WCB	Category B (Double Offset)	AISI 410 + ENP	RPTFE	ASTM A276 (UNS S41000)	N/A
		Category B (Triple Offset)	AISI 316	AISI 316 + Hard Coating	ASTM A564 Type 630 (UNS S17400)	Graphite Laminated with AISI 316
Ductile Iron	ASTM A536 Gr 65-45-12	Category A (Concentric)	ASTM B148 (UNS C95800)	NBR	ASTM B865 (UNS N05500)	N/A
			ASTM A536 Gr 65-45-12 + PA Coating	NBR	ASTM A276 (UNS S41000)	N/A
			ASTM A536 Gr 65-45-12 + PA Coating	NBR	ASTM A276 (UNS S31803)	N/A
Low Temperature Carbon Steel	ASTM A352 Gr. LCB	Category B (Triple Offset)	AISI 316	AISI 316 + Hard Coating	ASTM A564 Type 630 H1150 (UNS S17400)	Graphite Laminated with AISI 316
Stainless Steel	ASTM A351 CF8M	Category B (Double Offset)	AISI 316	RPTFE	ASTM A564 Type 630 H1150 (UNS S17400)	Graphite Laminated with AISI 316
Duplex Steel	ASTM A995 Gr. 4a	Category B (Double Offset)	Duplex (UNS S31803)	RPTFE	ASTM A276 (UNS S31803)	N/A
		Category B (Triple Offset)	Duplex (UNS S31803)	Duplex (UNS S31803) + Hard Coating	ASTM A276 (UNS S31803)	Graphite Laminated with Duplex (UNS S31803)
Super duplex Steel	ASTM A995 Gr. 6a	Category B (Double Offset)	Super duplex (UNS S32760)	RPTFE	ASTM A276 (UNS S32760)	N/A
		Category B (Triple Offset)	Super duplex (UNS S32760)	Super duplex (UNS S32760) + Hard Coating	ASTM A276 (UNS S32760)	Graphite Laminated with Super duplex (UNS S32760)
Nickel Aluminum Bronze	ASTM B148 (UNS C95800)	Category B (Double Offset)	ASTM B148 (UNS C95800)	RPTFE	ASTM B865 (UNS N05500)	N/A
		Category B (Triple Offset)	ASTM B148 (UNS C95800)	ASTM B148 (UNS C95800) + Hard Coating	ASTM B574 (UNS N10276)	Graphite Laminated with Hastelloy (UNS N10276)

¹ For all triple offset butterfly valves (category B), the VDS have taken into consideration typical configuration "(a) Seal ring fixed to body & hard coating on disc", as described in Figure A.10. Adequate adjustments shall be made for use of configuration "(b) Seal ring fixed to disc & hard coating on body".

A.7.5.5.2. DISC & SEAT CONFIGURATION

Table A.50 – Disc & Seat Configuration for butterfly valves

Config. #	Category (Ref. API 609)	Disc & Seat Configuration
0	Category A	Concentric
1	Category B	Double offset (bi-eccentric)
2	Category B	Triple offset (tri-eccentric)

A.7.5.5.3. END CONNECTION

Table A.51 – End connection configuration for butterfly valves category A (concentric)

TRIM Config.	Body Material	Disc	Stem	Maximum Pressure	Lug	Wafer	Double Flanged (Short Pattern)
#1	ASTM A536 Gr 65-45-12	ASTM B 148 (UNS B95800)	ASTM B865 (UNS N05500)	250 psig	1	2	3
#2	ASTM A536 Gr 65-45-12	ASTM A536 Gr 65-45-12 + PA Coating	ASTM A276 (UNS S41000)	150 psig	4	5	6
#3	ASTM A536 Gr 65-45-12	ASTM A536 Gr 65-45-12 + PA Coating	ASTM A276 (UNS S31803)	150 psig	7	8	9

Table A.52 – End connection configuration for butterfly valves category B (double / triple offset)

Config. #	Type
1	Lug
2	Wafer
3	Double Flanged (Short Pattern)

A.7.6. NON-METALLIC VALVE

A.7.6.1. TYPICAL CONFIGURATION

A.7.6.1.1. MATERIAL CONFIGURATION

Table A.53 – Material configuration for non-metallic valves

Config. #	Material
01	PVC
02	CPVC
03	FRP

A.7.6.2. DESIGN REQUIREMENTS FOR NON-METALLIC VALVE

A.7.6.2.1. The design of non-metallic ball valve shall consider the minimum pressure – temperature rating as follows:

Table A.54 – Minimum pressure (psig) – temperature rating for non-metallic ball valves

Material	PVC	CPVC	FRP
----------	-----	------	-----

Temp.	DN (NPS)		DN (NPS)		DN (NPS)		
	1/2 up to 1 1/2	≥ 2	1/2 up to 1 1/2	≥ 2	1/2 up to 1 1/2	2 up to 3	4 up to 10
23°C	250	150	250	150	275	250	150
30°C	235	150	250	150	275	250	150
35°C	212	150	245	150	275	250	150
40°C	192	144	232	146	250	225	140
45°C	N/A		211	137	250	225	140
50°C			188	128	250	225	140
55°C			179	119	250	225	140
60°C			170	101	250	225	140
65°C			161	92	250	225	140
70°C			140	83	232	210	130
75°C			134	74	232	210	130
80°C							

A.7.6.2.2. The design of non-metallic check valve shall consider the minimum pressure – temperature rating as follows:

Table A.55 – Minimum pressure (psig) – temperature rating for non-metallic check valves

Material	PVC	CPVC
Temp.		
23°C	150	150
30°C	150	150
35°C	150	150
40°C	144	146
45°C	N/A	137
50°C		128
55°C		119
60°C		110
65°C		101
70°C		92
75°C		83
80°C		74

A.7.6.2.3. The design of non-metallic butterfly valve shall consider the minimum pressure – temperature rating as follows:

Table A.56 – Minimum pressure (psig) – temperature rating for non-metallic butterfly valves

Material	PVC	CPVC
Temp.		
23°C	150	150
30°C	132	140
35°C	115	129
40°C	97	119
45°C	N/A	108
50°C		98
55°C		87
60°C		77

Material	PVC	CPVC
Temp.		
65°C		66
70°C		56
75°C		45
80°C		35

A.8. MATERIALS & FABRICATION

A.8.1. REQUIREMENTS FOR CASTING OF DUPLEX & SUPERDUPLEX

A.8.1.1. SCOPE

A.8.1.1.1. All valves made from stainless steel duplex and/or super duplex casting (UNS J92205, UNS J93404 and UNS J93380), without using bake sand foundry process, shall attend the minimum requirements listed herein for design, production, inspection and acceptance.

A.8.1.1.2. The requirements listed herein are applicable for axial, ball, gate, globe and check type flanged valves, for all pressure classes, with NPS \geq 2.

A.8.1.2. DOCUMENTATION

A.8.1.2.1. The Data Book of the valve shall contain all certificates related to all parts, according:

- chemical requirements;
- mechanical tests (tension, hardness and impact);
- metallurgic tests (resistance to localized corrosion and metallography for phase treatment counting and thermal treatment of the pilot casting);
- inspection reports (visual, using penetrant liquid and radiography);
- all thermal treatments;
- all WPS for defect repairing, approved by PETROBRAS or by a Classification Society indicated by PETROBRAS.
- welders qualification certificates, for repairs execution;
- cavity mapping, for bigger repairs of each part of the valve;
- welding report, for repairs of each part of the valve.

A.8.1.3. CHEMICAL REQUIREMENTS

A.8.1.3.1. The duplex steel used for manufacturing casting valves, for use in piping specifications B16, C16, E16, G16 or G16P, shall be in accordance with ASME SA-995 or ASTM A 995 Grade 4A (UNS J92205 or ACI CD3MN).

A.8.1.3.2. The super duplex steel used for manufacturing casting valves, for use in piping specifications B12, C12, H12, G12, G12P or J12, shall be in accordance with ASME SA-995 or ASTM A 995 Grade 5A (UNS J93404 or ACI CE3MN).

A.8.1.3.3. The super duplex steel used for manufacturing casting valves, for use in piping specifications B13 or C13, shall be in accordance with ASME SA-995 or ASTM A 995 Grade 6A (UNS J93380 or CD3MWCuN).

A.8.1.3.4. The representative sample of the chemical requirements of the valve shall be collected from the pouring ladle.

A.8.1.3.5. A representative sample for carbon, sulfur and nitrogen contents shall be collected from the furnace before

pouring into the ladle.

A.8.1.3.6. The addition of Niobium to the cast shall be avoided. The maximum allowable content of Niobium shall be 0,060% at the chemical requirements of the cast.

A.8.1.3.7. Adding Aluminum to the run shall be avoided. The maximum allowable content of Aluminum to the final chemical requirements shall 0,030%.

A.8.1.3.8. The levels of Nitrogen shall preferably be in the range of 0,20% up to 0,25%.

A.8.1.3.9. All consumables for the welding process shall have certification of their chemical requirements guaranteeing maximum levels of Niobium of 0,060%.

A.8.1.3.10. The chemical analysis of the elements shall be made in calibrated equipment according certified standards.

A.8.1.3.11. Whenever more than one ladle is used for one mold, the metal founded in each ladle shall be in accordance with the chemical specifications for the required level.

A.8.1.4. HEAT TREATMENT

A.8.1.4.1. The procedure for solubilization heat treatment used to the super duplex steel casting valves shall be in accordance with ASME SA-995 or ASTM A 995 Grade 5A (UNS J93404 or ACI CE3MN) and Grade 6A (UNS J93380 or ACI CD3MWCuN).

A.8.1.4.2. Solubilization heat treatment is the only acceptable treatment for production of the super duplex steel casting valves.

A.8.1.4.3. The maximum number of solubilization heat treatments allowed for a single valve is limited to three (03) at foundry and one (01) at machining shop. If more heat treatments are needed, the manufacturer shall submit it for PETROBRAS approval.

A.8.1.4.4. All heat treatments shall be monitored through thermocouples in the heat charge and in the furnace, and its register shall be inserted into the Data Book.

A.8.1.4.5. Welding repair is not allowed before heat treatment.

A.8.1.4.6. Whenever solubilization heat treatment is necessary after casting, it shall be performed in order to avoid distortions of the piece. It may be executed only one time.

A.8.1.4.7. The soaking time depends on the prior experience of the manufacturer, and shall guarantee full solubilization of the inter-metallic phases and the precipitates through the thickest dimension of the piece without causing dimensional distortions.

A.8.1.4.8. The pilot casting shall have possibility of extracting a test specimen for metallographic tests, which can be in any direction (longitudinal or transversal), representing a central session of the thickest part of the piece, according supplementary requirement S26.2 of ASTM A703, in order to verify the effectiveness and adjustment of the soaking time of the solubilization heat treatment. The results of this metallographic shall be part of the Data Book.

A.8.1.4.9. The result of the metallographic test shall indicate absence of inter-metallic phases and undesired precipitates – notably, the sigma phase, carbides and nitrates – in a 200X magnification, as well as indicate a level of ferrite in the range of 35 to 55%, according ASTM E 562.

A.8.1.4.10. For each casting with weight \geq 300 kg, specimens for mechanical and metallurgical tests shall be attached, according ASTM A703. These test specimens shall remain attached to the casting until the last thermal treatment. For pieces with weight $<$ 300 kg, a test specimen per run is accepted.

A.8.1.5. MECHANICAL AND METALLURGICAL TESTS

A.8.1.5.1. The mechanical and metallurgical tests shall be done after the last the solubilization heat treatment, and before machining the casting.

A.8.1.5.2. The mechanical tests to be performed are tension, hardness and impact (Charpy-V) testing, according ASTM A370.

A.8.1.5.3. The test specimens shall be obtained from cast test blocks, according ASTM A703. These blocks shall go through all the solubilization heat treatments before collecting the specimens for analysis.

A.8.1.5.4. One (01) test specimen shall be extracted for the tension test. The minimum acceptable values are according Table A.57 (ref. ASME SA-995 or ASTM A995).

Table A.57 – minimum values for tension tests

Grade	4A	5A	6A
UNS	J92205	J93404	J93380
Tensile Strength, ksi [Mpa] {kg/mm ² }	90 [620] {63}	100 [690] {70}	100 [690] {70}
Yield Strength, ksi [Mpa] {kg/mm ² }	60 [414] {42}	75 [515] {53}	65 [450] {46}
Elongation in 2" [50 mm], %	25	18	25

A.8.1.5.5. Three (03) test specimens shall be collected for the impact tests (Charpy-V). The tests shall be performed at a temperature of -46°C. The minimum values of absorbed energy shall be of 45J for an average of the three test specimens and 35J for each one of the test specimens.

A.8.1.5.6. The hardness tests shall be run on a test specimen collected from a test block, in a point representative of the central part of the thickest part of the casting, according to the supplementary requirement S26.2 of ASTM A703. The maximum hardness shall not be above 32 HRC (or 310 HB or 330 HV10), considering the average of three measurements. Castings with weight < 300 kg shall be tested individually and shall render specific hardness values less or equal to the pilot casting on the surface.

A.8.1.5.7. A test specimen shall be collected from the pilot casting, in order to perform the corrosion tests according ASTM G48 Method A. The test shall be run for 24 hours at a temperature of 50°C. The acceptance criteria shall be according Grade 5A (UNS J93404 or CE3MN) and Grade 6A (UNS J93380 or CD3MWCuN):

- no pites located at 20 X magnification;
- loss of mass less than 4,0 g/m².

A.8.1.5.8. The test to define the levels of ferrite shall be performed according ASTM E562. The test specimen shall be collected from a cast test block connected to a casting that would represent a certain run. The acceptable range is 35 up to 55% of ferrite.

A.8.1.6. CASTING INSPECTION

A.8.1.6.1. VISUAL

A.8.1.6.1.1. visual inspection shall be made on all castings before and after each solubilization heat treatment, after pre-machining (whenever applicable) and the final machining.

A.8.1.6.1.2. all accessible surfaces, internal and/or external, shall be visually examined, comparing acceptable

discontinuities and superficial finishing according MSS SP-55 or comparison rules of Steel Casting Research and Trading Association (SCRATA) adopted in ASTM A802, or other standard considered equivalent by a set deal between the manufacturer and PETROBRAS.

A.8.1.6.1.3. the levels of acceptance for visual inspections are set in ASTM A802, and are:

- level II, for non-machined surfaces;
- level III, for surfaces to be machined, as long as the machining completely eliminates the discontinuities.

A.8.1.6.1.4. all castings that presents, in one or more surfaces, independent of how serious or how extensive the defects are, or whether it allows repairs using welding or not, the following defects shall be considered UNACCEPTABLE:

- chaplet - discontinuity due to the incomplete fusion of the supports of chills and cores;
- shrinkage - cavity resulting from contraction while solidifying;
- shift - discontinuity due to displacement of contact edges of the molding boxes;
- misrun - insufficient founded metal in the casting;
- shut metal - discontinuity due to the encounter of two currents of metal that have not been well mixed;
- veins - discontinuity due to movement or cracking of the sand mold;
- rat tail - depression on the surface of the piece caused by waves or failure in the mold surface;
- internal chills - discontinuity caused by incomplete fusion of devices used to increase the cooling rate in determined places.

A.8.1.7. LIQUID PENETRANT INSPECTION (LPI)

A.8.1.7.1. LPI shall be performed by Level 2 inspectors qualified by the “Sistema de Nacional de Qualificação e Certificação” (National System of Qualification and Certification) in Non Destructive Testing (SNQC/END), or by another bureau according to ISO 9712 or EN 473.

A.8.1.7.2. LPI shall be performed on every produced casting, on all accessible surfaces (internally and/or externally), after the final machining. All castings that make up the valves of the same order shall undergo inspection using Liquid penetrant.

A.8.1.7.3. LPI shall be performed according ASTM E165.

A.8.1.7.4. indications shall be classified according APPENDIX 8 (8-3) of ASME SEC VIII Div. 1.

A.8.1.7.5. The acceptance criteria shall be according ASME SEC VIII DIV 1 APPENDIX 7.

A.8.1.8. RADIOGRAPHY OF VALVE PARTS AND PILOT CASTING

A.8.1.8.1. radiographic inspection shall be executed by Level 2 inspectors qualified by the “Sistema de Nacional de Qualificação e Certificação” (National System of Qualification and Certification) in Non Destructive Testing (SNQC/END), or by certification according ISO 9712 or EN 473.

A.8.1.8.2. radiographic inspection shall be performed on the pilot casting (body, cap and shutter), after conclusion of heat treatment. For parts which pressure classes are 900 and above, it is mandatory to perform radiographic inspection on 100% of the final pieces, in the critical regions defined in ASME B16.34.

A.8.1.8.3. radiographic inspection shall be performed according ASTM E94 and ASTM E1030.

A.8.1.8.4. The list of parts to be radiographed and the acceptance criteria shall be according ASME B16.34.

A.8.1.8.5. If all indications are classified as ACCEPTABLE, no other piece than the pilot casting shall be radiographed.

A.8.1.8.6. If one or more conditions were classified UNACCEPTABLE, the pilot casting shall be fixed or scrapped, a report shall be issued with causes analyses and solutions, and another piece shall be radiographed. If the second piece is approved, no more piece needs to be radiographed. If the second piece also presents UNACCEPTABLE indications, all pieces equal to the pilot casting of the order shall be radiographed in the areas rejected for the pilot casting and for the second casting. The second casting and the subsequent piece of the order shall be repaired whenever identified an unacceptable indication, otherwise it shall be rejected.

Table A.58 - maximum levels of severity by defect by thickness

Defects by Thickness	Thickness < 2"	2 ≤ Thickness < 4 1/2"	4 1/2" ≤ Thickness < 12"
Standards	ASTM E446	ASTM E186	ASTM E280
Porosity (A)	A2	A3	A3
Sand or Slag (B)	B3	B3	B3
Shrinkage Porosity (CA)	CA2	CA3	CA3
Shrinkage Porosity (CB)	CB3	CB3	CB3
Shrinkage Porosity (CC)	CC3	CC3	CC3
Shrinkage Porosity (CD)	CD3	-	-
Cracks (D)	None	None	None
Shrinkage Cracks (E)	None	None	None
Inserts (F)	None	None	None

A.8.1.9. ULTRASONIC INSPECTION

A.8.1.9.1. Ultrasonic inspection shall be executed by Level 2 inspectors qualified by the “Sistema de Nacional de Qualificação e Certificação” (National System of Qualification and Certification) in Non Destructive Testing (SNQC/END), or by certification according ISO 9712 or EN 473.

A.8.1.9.2. Ultrasonic inspection shall be performed according ASTM A388 (forgings) and ASTM A609 (castings).

A.8.1.9.3. Acceptance criteria shall be according ASME B16.34.

A.8.1.10. REPAIRS

A.8.1.10.1. All kind of repairs shall be made by welding.

A.8.1.10.2. All repairs shall have a specific WPS approved by welding inspector level 2, according type of equipment, and by a Classification Society indicated by PETROBRAS. This WPS shall be based on ASTM A488.

A.8.1.10.3. The WPS and the qualification of the welder shall be according acceptance criteria established in I-ET-3010.00-1200-955-P4X-001.

A.8.1.10.4. The repair shall be witnessed by a Level I welding inspector.

A.8.1.10.5. Before any repair, the surface shall be inspected by visual and preferably magnetic particle and liquid

penetrant inspection.

A.8.1.10.6. Twenty four hours (for hydrogen diffusion) after the last welding repair, it shall be repeated the same NDT used to identify the defect. For extensions over 50 mm length and over 20% thickness depth a ultrasonic test or radiography shall be executed. Acceptance criteria shall be according ASME B16.34.

A.8.1.10.7. It is mandatory to perform post weld heat treatment for carbon steel or solubilization on stainless steel when:

A.8.1.10.7.1. The repair is demanded after leaking in the hydrostatic test;

A.8.1.10.7.2. The cavity after the repair preparation is over 20% of thickness depth or 25 mm, whichever is smaller;

A.8.1.10.7.3. The extension (area) of the cavity is bigger than 65 cm².

A.8.1.10.8. Test Specimens for Counter-Sample - Chemical Analysis and Mechanical Testing: the minimum period established for storage, by the foundry, of test specimens for sample are twelve (12) months.

A.8.1.11. MACHINING

A.8.1.11.1. The machining of the casting shall only be executed after heat treatment.

A.8.1.11.2. No kind of machining may be done after hydrostatic test.

A.8.1.11.3. Machined surfaces shall be according valve design as tolerance and rugosity.

A.8.1.11.4. No kind of metallurgical changing may occur caused by heating during machining. If necessary shall be a metallographic replica exam.

A.8.1.11.5. Liquid penetrant on seal surface shall be ZERO defect.

A.8.2. COATINGS

A.8.2.1. METALLIC COATING

A.8.2.1.1. ELECTROLESS NICKEL PLATING (ENP)

A.8.2.1.1.1. Whenever specified in the VDS, it shall be applied on the indicated parts an ENP coating obtained by chemical reactions leading to a plating composed of 90% Nickel and 10% Phosphorus. This coating shall be in accordance with ASTM B 733 attending classification SC4, Type V, heat treatment Class 2.

A.8.2.1.1.2. The minimum thickness of the ENP coating shall be 0,003 inch (75 µm).

A.8.2.1.1.3. All components shall be traceable for the details of the coating procedure, coating conditions and date of application.

A.8.2.1.1.4. The manufacturer shall issue inspection certificates of the ENP coating, and each certificate shall identify the plant where the treatment is performed and the history of the process. Also, it shall list all serial numbers of the parts coated together with the material grades and the overall geometry of those parts.

A.8.2.1.2. COBALT-CHROMIUM (CO-CR) WELD OVERLAY

A.8.2.1.2.1. Whenever specified in the VDS the term Stellite, it shall be applied a weld overlay of cobalt-chromium (Co-Cr) alloy on indicated parts.

A.8.2.1.2.2. The specification of the cobalt-chromium (Co-Cr) alloy shall fulfil the requirements of the design standard indicated in the VDS.

A.8.2.1.2.3. For valves with DN < 2, which is not possible to apply cobalt-chromium (Co-Cr) weld overlay, the manufacturer shall consider to use integral parts of cobalt-chromium (Co-Cr) alloy.

A.8.2.1.2.4. For the parts which materials are made of solid cobalt-chromium (Co-Cr) alloy there is no need to apply an overlay.

A.8.2.1.3. STAINLESS STEEL (AISI 316) WELD OVERLAY

A.8.2.1.3.1. Whenever specified in the VDS, it shall be applied a minimum of 3,0 mm thick weld overlay in stainless steel grade 316L on seat pockets and stem seal contact faces on the body.

A.8.2.1.3.2. For floating ball valves, this requirement is not applicable to the seat pockets as soon as the seat ring is made of an integral, solid thermoplastic material (i.e.: valves having a fixed seat), but it applies to stem sealing areas in all cases (for floating ball valves having also a floating seat design, the seat-to-body sealing area shall consequently be overlaid).

A.8.2.1.3.3. For valves with $DN < 2$, which is not possible to apply stainless steel weld overlay, the manufacturer shall consider to use integral parts of stainless steel or CRA alloy.

A.8.2.1.3.4. For the parts which materials are made of stainless steel, duplex, super duplex or solid Inconel 625 there is no need to apply an overlay.

A.8.2.1.3.5. Dilution on welded surface shall not exceed 10% of base metal.

A.8.2.1.4. NICKEL ALLOY (INCONEL 625) WELD OVERLAY

A.8.2.1.4.1. Whenever specified in the VDS the term Inconel 625, it shall be applied a weld overlay of a nickel alloy UNS N06625 on indicated parts.

A.8.2.1.4.2. The areas of such parts that shall be welded are indicated in the VDS. The manufacturer shall attend to the requirement of partial or full cladding.

A.8.2.1.4.3. The weld overlay thickness shall be sufficient in order to obtain a minimum of 3,0 mm thick protective layer in the final machined condition.

A.8.2.1.4.4. For valves with $DN < 2$, which is not possible to apply Inconel 625 weld overlay, the manufacturer shall consider to use integral parts of Inconel 625.

A.8.2.1.4.5. For the parts which materials are made of solid Inconel 625 there is no need to apply an overlay.

A.8.2.1.4.6. Dilution on welded surface shall not exceed 10% of base metal.

A.8.2.2. HARD COATING

A.8.2.2.1. CHROMIUM ELECTROPLATE

A.8.2.2.1.1. Whenever specified hard coating in the VDS, a hard coating of chromium electroplate may be applied on the indicated parts of a metal to metal ball valve, as described in Table A.32.

A.8.2.2.2. CHROME CARBIDE

A.8.2.2.2.1. Whenever specified hard coating in the VDS, a hard coating of chrome carbide may be applied on the indicated parts.

A.8.2.2.2.2. When applicable, hard coating of chrome carbide shall be applied by High Velocity Oxy-Fuel (HVOF) process.

A.8.2.2.2.3. The hard coating of chrome carbide shall achieve a minimum thickness of 200 μm after grinding and lapping.

A.8.2.2.2.4. The hard coating shall be carefully applied and inspected to ensure that the finish is smooth, fine grained,

adherent, and free from blisters, pits, nodules, indication of burning, edge buildup, and other defects.

A.8.2.2.2.5. The hard Coating thickness shall be measured to confirm the results of it against the specified thickness.

A.8.2.2.3. TUNGSTEN CARBIDE

A.8.2.2.3.1. Whenever specified hard coating in the VDS, a hard coating of tungsten carbide may be applied on the indicated parts.

A.8.2.2.3.2. When applicable, hard coating of tungsten carbide shall be applied by High Velocity Oxy-Fuel (HVOF) process.

A.8.2.2.3.3. The hard coating of tungsten carbide shall achieve a minimum thickness of 200 µm after grinding and lapping.

A.8.2.2.3.4. The hard coating shall be carefully applied and inspected to ensure that the finish is smooth, fine grained, adherent, and free from blisters, pits, nodules, indication of burning, edge buildup, and other defects.

A.8.2.2.3.5. The hard coating thickness shall be measured to confirm the results of it against the specified thickness.

A.8.2.2.4. CHROME-NICKEL SPRAY AND FUSE

A.8.2.2.4.1. Whenever specified hard coating in the VDS, a hard coating of chrome-nickel basis with metallurgical bonding may be applied on the indicated parts.

A.8.2.2.4.2. When applicable, hard coating of chrome-nickel basis with metallurgical bonding shall be applied by Flame Spray and Fuse process.

A.8.2.2.4.3. The hard coating of chrome-nickel spray and fuse shall achieve a minimum thickness of 500 µm after grinding and lapping.

A.8.2.2.4.4. The hard coating shall be carefully applied and inspected to ensure that the finish is smooth, fine grained, adherent, and free from blisters, pits, nodules, indication of burning, edge buildup, and other defects.

A.8.2.2.4.5. The hard Coating thickness shall be measured to confirm the results of it against the specified thickness.

A.8.2.3. NON-METALLIC COATING

A.8.2.3.1. ORGANIC COATING

A.8.2.3.1.1. The use of valves with organic coating may be considered as option for specific service applications, such as with seawater service.

A.8.2.3.1.2. Whenever applicable, the pipe specification (*spec*) may present an organic coated valve code as an option.

A.8.2.3.1.3. Only ball, gate and globe valve types classified as VSL-1 and VSL-2 may consider the use of organic coating.

A.8.2.3.1.4. The VDS of organic coated valve shall indicate/allow, as principle, the application of organic coating only in the body/closure material of the valve.

A.8.2.3.1.5. For small size valves (e.g.: NPS < 3), when organic coating is not applicable, the body may be made of a material with the same corrosion resistance of the materials specified for the internals.

A.8.2.3.1.6. The specification of the organic coating shall be according I-ET-3010.1M-1200-956-P4X-002- General Painting.

A.8.2.3.1.7. RTJ flanges may be organic coated, except the ring groove which shall attend the orientation indicated in the pipe specification (*spec*).

A.8.2.3.2. POLYAMIDE (PA) COATING

A.8.2.3.2.1. The use of valves with polyamide (PA) coating may be considered as option for specific service applications, such as with seawater service.

A.8.2.3.2.2. Whenever applicable, the pipe specification (*spec*) may present an polyamide (PA) coated valve code as an option.

A.8.2.3.2.3. Only concentric butterfly valves (Category A) classified as VSL-1 may consider the use of polyamide (PA) coating.

A.8.2.3.2.4. The VDS of polyamide (PA) coated valve shall indicate/allow, as principle, the application of polyamide (PA) coating only in the disc material of the valve.

A.8.2.3.2.5. The acceptable specifications of the polyamide (PA) coating are PA 11 and PA 12.

A.8.3. ALTERNATIVE MATERIALS

A.8.3.1. All materials listed in the VDS shall be considered as standardized materials for valve parts, but are not exclusive solutions. Therefore, the valve manufacturer may propose alternative materials (equivalent or better), conditioned to PETROBRAS approval.

A.8.3.2. For a material to be accepted as equivalent or better, it shall have the same or better mechanical (i.e. yield strength, hardness, etc.) and anti-corrosive properties (measured by PREN), be suitable for temperature range presented in the VDS whilst not being susceptible to phenomenon such as brittle fracture or stress corrosion cracking.

A.8.3.3. Charpy impact testing is required for all materials, considering minimum temperature listed in ASME B31.3, section 323 or as listed in the VDS, whichever is lower. All metallic materials shall be suitable for minimum temperature service of -29°C.

A.8.3.4. Some examples of alternative materials are:

A.8.3.4.1. For pressure-containing parts, forging materials are acceptable in place of casting materials, but not vice-versa.

A.8.3.4.2. For remaining internal parts (i.e.: non pressure-containing), forgings and castings are interchangeable as long as they have the same desired properties (i.e.: mechanical properties, corrosion resistance, maximum or minimum hardness, and other properties as applicable).

A.8.3.4.3. Superduplex (UNS S32760) may be used as replacement for duplex (UNS S31803), but not vice-versa.

A.8.3.4.4. Superduplex and duplex steels shall not be used for chlorinated seawater services (SW).

A.8.3.4.5. Nickel Aluminum Bronze (UNS C95800) may be used as replacement for bronze B62 (UNS C83600), but not vice-versa.

A.8.3.4.6. Higher mechanical strength alloys such as ASTM A694 F60 or ASTM A694 F65 are acceptable instead of ASTM A105 or ASTM A216 Gr WCB. For Inconel clad valves used for sour service, the base material shall be NACE compliant.

A.8.3.4.7. Superduplex and duplex steels may be replaced by carbon steel with 3 mm of Inconel 625 overlay, and vice-versa if low temperature requirements are satisfied. Additionally, the pressure-temperature rating shall be validated.

A.8.3.4.8. Austenitic steels with PREN number less than that of 316/316L shall not be used on offshore facilities (e.g.: AISI 304 and AISI 304L stainless steel materials shall not be used).

A.8.3.4.9. Internal parts made of martensitic stainless steels (e.g.: AISI 410) may be replaced by higher chromium alloys such as ASTM A564 Gr 630 H1150 (17-4PH), superduplex or duplex steels.

A.8.3.4.10. ASTM A350 LF3 may be replaced with ASTM A350 LF2 CL1, in case minimum temperature is above - 46°C.

A.8.3.4.11. Internal parts made of austenitic stainless steels may be replaced with higher chromium alloys, if low temperature requirements are satisfied:

- Down to - 46°C: ASTM A350 LF2 CL1 with 3 mm of Inconel 625 overlay or ASTM A564 Gr 630 H1150 (17-4PH);
- Down to - 51°C: Duplex (UNS S31803) or Superduplex (UNS S32760);
- Down to - 100°C: ASTM A350 LF3 with 3 mm of Inconel 625 overlay, ASTM A522 type I with 3 mm of inconel 625 overlay or full inconel parts.

A.8.3.4.12. Low temperature carbon steel parts (i.e.: ASTM A350 LF2, ASTM A350 LF3) may be used in lieu of regular carbon steel parts (e.g.: ASTM A105, ASTM A216 WCB).

A.9. INSPECTION & TESTING

A.9.1. INSPECTION REQUIREMENTS

A.9.1.1. INSPECTION AND TESTING PLAN (ITP)

A.9.1.1.1. The ITP shall be issued by the supplier and submitted to PETROBRAS or EPC contractor approval.

A.9.1.1.2. The ITP shall allow the identification of stages, through the valve production cycle, where it shall be done checks or inspections, including those carried out by material or service suppliers.

A.9.1.1.3. The ITP shall indicate the types of examinations, tests or checks to be made, as well as procedures and/or applicable instructions, acceptance criteria and issued records.

A.9.1.1.4. The ITP shall contain register of critical quotas as defined by the manufacturer, including, at least, standardized quotas in the construction and design standards of valves.

A.9.1.1.5. The ITP shall contain the procedures and instructions for inspection of all expected activities.

A.9.1.1.6. The inspection shall be performed by PETROBRAS or EPC contractor.

A.9.1.2. RECEIVING INSPECTION

A.9.1.2.1. The receiving inspection shall be performed without causing damages to the package and without compromising the preservation of the valves.

A.9.1.2.2. It shall be checked the valve and its components as the Data Book, identification (e.g. valve serial number, actuator serial number, pressure class, etc.) and manufacturer manual for handling, storage and preservation.

A.9.1.2.3. After verifying the documentation and attesting its conformity, the packed shall be stored according item A.10.

A.9.1.3. NON DESTRUCTIVE TESTING (NDT)

The execution of NDT shall follow specific requirements, according type of material:

A.9.1.3.1. CAST IRON AND BRASS VALVES:

- 100% visual inspection;
- for body and bonnet made of cast iron or forgings, pressure class 150 and 300, magnetic particle testing is required at least in 20% of each batch material.

A.9.1.3.2. CARBON STEEL VALVES:

- 100% visual inspection;

- for body and bonnet made of forgings, pressure class 600, 900, 1500, 2500 and 10.000psi, magnetic particle testing is required in 100% of each batch material;
- for body and bonnet made of casting, pressure class 600, 900, 1500, 2500 and 10.000psi, radiographic examination in critical areas is required in 100% of each batch material.

A.9.1.3.3. CARBON ALLOY STEEL VALVES:

a) ASTM A522 Type I (forging):

- 100% visual inspection;
- for body and bonnet made of forgings, pressure class 150 and 300, liquid penetrant inspection is required at least in 20% of each batch material;
- for body and bonnet made of forging, pressure class 900, 1500, 2500 and 10.000psi, liquid penetrant inspection is required in 100% of each batch material;
- for body and bonnet made of castings, pressure class 900, 1500, 2500 and 10.000psi, radiographic examination is required in 100% in critical areas.

Table A.59 – Chemical composition for ASTM A522 – Type I

Chemical Composition	Carbon (max.)	Manganese	Phosphorus	Sulfur	Silicon	Nickel
ASTM A522 Type I	0,06	0,59	< 0,005	< 0,001	0,28	9,08

A.9.1.3.4. STAINLESS STEEL VALVES:

- 100% visual inspection;
- for body and bonnet made of forgings, pressure class 150 and 300, liquid penetrant inspection is required at least in 20% of each batch material;
- for body and bonnet made of forgings, pressure class 900, 1500, 2500 and 10.000psi, liquid penetrant inspection is required in 100% of each batch material;
- for body and bonnet made of casting, pressure class 900, 1500, 2500 and 10.000psi, radiographic examination is required in 100% in critical areas.

A.9.1.3.5. STAINLESS STEEL DUPLEX AND SUPER DUPLEX VALVES:

- 100% visual inspection;
- for body and bonnet made of forgings, pressure class 150 and 300, liquid penetrant inspection is required at least in 20% of each batch material;
- for body and bonnet made of forgings, pressure class 900, 1500, 2500 and above, liquid penetrant inspection is required in 100% of each batch material;
- for body and bonnet made of casting, pressure class 900, 1500, 2500 and above, radiographic examination is required in 100% in critical areas.

A.9.1.3.6. Additional Requirements:

- all valves specified for hydrogen sulfide service shall be in strict accordance with the requirements of the ISO 15156;

- visual inspection shall be according to ASME BPV section V. The acceptance criteria shall be according to MSS SP-55 specification;
- liquid penetrant and magnetic particles testing shall be according to ASME BPV section V. The acceptance criteria shall be according to ASME B16.34 specification for class pressure up to 600#. For higher class pressures the acceptance criteria shall be according to ASME B16.4, with the exception that no linear indication shall be accepted;
- visual inspection shall be according to ASME BPV section V. The acceptance criteria shall be according to ASME B16.34 specification;
- radiographic examination shall be according to ASME BPV section V and ASTM E94. The acceptance criteria shall be according to ASME B16.34 specification;
- for castings valves NDT examinations shall focus on critical areas.

A.9.2. DESIGN VALIDATION

A.9.2.1. The design validation of a valve is requested according its VSL classification, as presented as follows:

Table A.60 – Design validation requirements according VSL classification

VSL Classification	VSL-1	VSL-2	VSL-3	VSL-4
Design Validation	No	Design analytical approval	Design validation test approval (PVT)	

A.9.2.2. For VSL-1 valves, no design validation is required. In this case, the manufacturer shall perform the design and manufacture the valve attending all requirements listed in the applicable standards (e.g.: API 6D, API 6A, etc.).

A.9.2.3. For VSL-2 valves, design validation is required at documentation level. In this case, the manufacturer shall have an analytical approval of the valve design. To attend this kind of design validation, the manufacturer shall submit for PETROBRAS approval:

- Certificate of approval, issued by a 3rd party, referred to an analytical approval of the valve design, according normative requirements (e.g.: NBR 15827, API 6D, API 6A, API 600, API 609, etc.); or
- A valid API monogram of the valve design, complying to all normative requirements of quality and design.

NOTE: In case the manufacturer has already performed a PVT test in the past on a representative prototype of the valve design or on a valve which scaling may be considered valid, the requirement of design analytical approval may be demonstrated by the certificate of approval. This certificate, referred to the execution to this PVT test, shall be issued by a 3rd party.

A.9.2.4. For VSL-3 and VSL-4 valves, design validation is required at PVT test execution level. In this case, the manufacturer shall perform all PVT tests on a representative prototype of the valve that will be supplied.

NOTE: The manufacturer is free of charge on performing the PVT test, in case it is presented a certificate of approval, issued by 3rd party, referred on a PVT test performed in the past, on a representative prototype of the valve that will be supplied or on a valve which scaling may be considered valid.

A.9.2.5. In the case of PVT test execution, the following Standards may be considered to the test:

- NBR 15827; or
- API 6A, considering PSL 3G, PR2 (Appendix F); or
- API 6AV1.

NOTE: In case of missing technical requirements, including acceptance criteria (e.g.: ball valve on API 6A), the PVT test procedure shall be elaborated from better suited standards such as NBR 15827, and submitted to PETROBRAS approval.

A.9.2.6. For a supply of a fire tested valve, the manufacturer shall also present a certificate of approval, issued by 3rd party, complying to ISO 10497.

A.9.2.7. For a supply of a fugitive emissions valve, the manufacturer shall also present a certificate of approval, issued by 3rd party, complying to ISO 15848.

A.9.3. FACTORY ACCEPTANCE TEST (FAT) REQUIREMENTS

A.9.3.1. TEST MEDIUM

A.9.3.1.1. The manufacturer shall consider the use of the following test medium:

A.9.3.1.1.1. For all tests with liquid: It shall be used fresh water with an addition of corrosion inhibitor.

NOTE: The chloride content of test water in contact with austenitic and duplex stainless steel wetted components of valves shall not exceed 30 µg/g (30 ppm by mass) and the water temperature shall not be greater than 38°C (100°F) during the testing period.

A.9.3.1.1.2. For high pressure gas tests: It shall be used dry nitrogen (N₂).

A.9.3.1.1.3. For low pressure gas tests: It may be used dry air or nitrogen (N₂).

A.9.3.2. TEST BENCH

A.9.3.2.1. The manufacturer shall attend all requirements herein stated for the design and assembly of the test bench dedicated to perform the FAT tests of the valve / actuator.

A.9.3.2.2. It shall be considered, as minimum, the use of the following equipment:

- a) Test Panel with devices for manual and automatic operation, provided of pressure transmitters, digital indicators or controllers, pressure meters, solenoid valves, relays, end-of-stroke indicators, cycles counter, etc., as well as hydraulic systems (hydraulic units, etc.) compatible with the flows and test pressure levels for the valve / actuator which will be tested.
- b) Fittings and tubing of stainless steel.
- c) High pressure hoses.
- d) Torque tool.
- e) Data acquisition system, with capacity to adequately record the values of pressure and / or torque during test execution.

A.9.3.2.3. The manufacturer shall take attention to the adequacy of protection for personnel carrying out the testing, in

the event of failure of a valve, connection or equipment during the test. Additional caution shall be taken whenever high pressure gas tests are required.

A.9.3.3. MONITORING PORTS FOR ACTUATED VALVES

A.9.3.3.1. During execution of any valve cycle, the following pressure ports shall be monitored / registered:

- a) Valve upstream pressure
- b) Valve downstream pressure
- c) Valve body pressure
- d) Actuator input (e.g.: hydraulic or pneumatic pressure, electric current)
- e) Valve stroke

A.9.3.4. LEAKAGE IDENTIFICATION

A.9.3.4.1. The test bench shall have the capacity to monitor eventual leakages and allow to measure the volume in order to allow verification of the acceptance criteria.

A.9.3.4.2. Hydraulic lines must be, whenever technically possible, built with short stainless steel tubing, to increase the sensitivity to leakage detection. With the same purpose a procedure for purging the air of the valve body, the actuator and the test panel must be foreseen. This procedure shall be approved by PETROBRAS.

A.9.3.4.3. During sealing tests with liquid, whenever visual observation of leakage in a direct way is not possible, leakages can be monitored by pressure variation.

A.9.3.4.4. In case of leakage identification by pressure variation, one example of a method of quantifying sensitivity of the test bench would be the creation of a "leakage", small and controlled, where the leaked volume variation would be co-related with the pressure drop generated by this "leakage", for each test condition (pressure value, upstream lines, downstream, ambient temperature, etc.).

A.9.3.4.5. Detection of a leakage shall be associated with the identification of a continuous pressure variation, without occurring its stabilization along the time and since the effects of temperature variation can be disregarded (or compensated). Thus, the pressure drop in an upstream line or pressure rise in a downstream line, without stabilization of these pressure variations shall be considered as leakage.

A.9.3.4.6. In case of leakage identification by using level variation in a capillary, its diameter shall be compatible with the capacity of identifying small leakages / volumes.

A.9.3.4.7. Pneumatic shell test shall be performed using inert gas, such as mixture of 99 % nitrogen with a 1 % helium, tracer measured using a mass spectrometer, in order to guarantee leakage detection. Alternatively, if nitrogen (100%) is used as test medium, the valve shall be submerged.

A.9.3.4.8. In case of monitoring gas leakage at the pressure ports, for higher and constant leakages it shall be considered the use of flowmeters operating inside 20% to 80% of the nominal capacity of it.

A.9.3.4.9. For monitoring gas leakage on pressure ports for smaller or inconstant leakages it shall be performed by using scale burette where a flexible hose is inserted totally on a burette (or at least above the meniscus) and the set is submerged on a transparent aquarium filled with clean water. Monitoring of leakage shall be done by registering the displacement of the meniscus line inside the burette, which can be seen through the aquarium.

A.9.3.4.10. Before each type of test, the manufacturer shall present the test bench set-up in order to demonstrate that it

is assembled on a correct way to perform the tests and monitor eventual leakages. The following items shall be concerned during this presentation:

- a) It shall be verified that the pressure source is connected to the correct pressure port.
- b) It shall be verified that all test devices are properly assembled, such as if flanges and fittings are tightened, check of instrumentation valves position (fully opened or fully closed), identification of hoses (which shall be in a good shape, without creases, holes or tears), etc.;
- c) Before gas tests, if the valve is completely purged.
- d) Check of safety rules appliance, prior to beginning the tests.

A.9.3.5. FAT SEQUENCE

A.9.3.5.1. All manual and actuated valves shall be subjected to a Factory Acceptance Test (FAT) prior to delivery and/or shipping the valve.

A.9.3.5.2. It shall be considered the execution of FAT for the valve and its actuator.

A.9.3.5.3. Otherwise agreed, the FAT shall be performed with the actuator assembled onto the valve.

A.9.3.5.4. A functional test of valve + actuator shall be considered in order to guarantee adequate performance of the set.

A.9.3.5.5. Valves wich design contains fugitive emissions requirement shall also perform additional FAT tests according item A.9.3.6.

A.9.3.5.6. HIPPS valves shall also perform additional FAT tests according item A.9.3.7.

A.9.3.5.7. Whenever specified in the purchase order and/or Contract to comply with “Specific Inspection Requirement for Industrial Valves - ET-0000.00-0000-972-P8L-023”, the manufacturer shall attend the specific requirements of pressure tests listed in item 5.12 of ET-0000.00-0000-972-P8L-023.

NOTE: Any other conflict between ET-0000.00-0000-972-P8L-023 and this document shall be presented for PETROBRAS evaluation.

A.9.3.5.8. The FAT of bronze globe valves shall follow MS SP-80. The FAT of other globe valves shall follow BS 1873 / BS 12266 or API 623 requirements, as applicable, and applicable tests listed in these Standards shall be performed.

A.9.3.5.9. The FAT of butterfly valves (except to the triple offset design) shall follow API 609 / API 598 requirements, and applicable tests listed in these Standards shall be performed.

A.9.3.5.10. The FAT of ball, gate, check, plug, axial and triple offset butterfly valves shall follow:

A.9.3.5.10.1. Pressure tests according the respective QSL requirement for each VSL classification:

Table A.61 – QSL requirement according VSL classification

VSL Classification	VSL-1	VSL-2	VSL-3	VSL-4
QSL	QSL-2	QSL-3 (Note 1)	QSL-3	QSL-4
Note 1 – For liquid service application, it may be considered QSL-2, except for hydrocarbon.				

- a) For VSL-1 valves, it shall be performed pressure tests according API 6D QSL-2 requirements.

- b) For VSL-2 valves, it shall be performed pressure tests according API 6D QSL-3 requirements. For liquid service application, it shall be performed pressure tests according API 6D QSL-2 requirements.
- c) For VSL-3 valves, it shall be performed pressure tests according API 6D QSL-3 requirements.
- d) For VSL-4 valves, it shall be performed pressure tests according API 6D QSL-4 requirements.

A.9.3.5.10.2. In addition to the pressure tests required by Table A.61, the FAT of ball valves shall consider the execution of the following supplementary tests listed in Annex H of API 6D: H.5, H.6, H.7, H.8, H.9, H.11.

NOTE: Otherwise agreed, the supplementary tests H.9 and H.11 shall be performed using gas as test medium.

A.9.3.5.10.3. The acceptable leakage rate for the tests shall be according API 6D, except to:

- a) Hydrostatic seat test and low-pressure gas seat test of metal seated valves: the acceptable leakage shall be ISO 5208 Rate B. For DBB tests the acceptable leakage is 2 X B.
- b) High-pressure gas seat test of metal seated valves: the acceptable leakage rate shall be 2 X C (two times ISO 5208 Rate C). For DBB tests the acceptable leakage is 4 X C.

NOTE: Whenever DBB feature is required for the valve design at closed or closed & opened position, it shall be considered the execution of DBB test on both conditions.

- c) Triple offset butterfly valves: The acceptable leakage rate for all HP/LP sealing (i.e.: seat) tests shall be ISO 5208 Rate A.

A.9.3.5.10.4. Prior to perform the drive train strength test, listed in item H.7 of API 6D, the manufacturer shall provide the following information:

- a) Drive train engineering data (i.e.: stem calculation), demonstrating that the design thrust or torque for all drive train calculations is at least two times the breakaway thrust or torque of the valve (i.e.: maximum thrust or torque required to operate a valve at maximum pressure differential).
- b) Actuator engineering data (e.g.: gearbox, hydraulic, etc.), demonstrating that proper safety factor has been taken into account.
- c) Test fixture design data, in order to guarantee that the test fixture used to block the obturator is able to withstand the loads of the test and it would not damage the surface of the parts in contact (i.e.: ball / seats edges, sealing region).
- d) The selected torque value (acc. item H.7 of API 6D) that will be applied on the drive train strength test. If the valve actuator (e.g.: gearbox, hydraulic, etc.) is used to generate the torque test, it shall be checked the values of maximum output torque of the actuator and the selected torque value for the test, in order to confirm its compatibility.

NOTE: The drive train strength test shall be performed prior to the sealing tests (i.e.: seat test) and it may be done in only one valve of the lot, per nominal, per actuator type (e.g.: gearbox, hydraulic, etc.), and per pressure class, conditioned to:

- Agreement by test inspector of all documentation listed in this item.

- No failures on the drive train strength tests. If one valve of the lot failures on the drive train strength, the others valves with same design premise shall perform the test.

A.9.3.6. FUGITIVE EMISSIONS FAT

A.9.3.6.1. Whenever specified in the VDS that the valve shall be fugitive emissions approved, a minimum of one valve of the lot shall be selected at random from each production lot of valves per valve type, pressure class and nominal size, and tested according ISO 15848 Part 2.

A.9.3.6.2. The manufacturer shall prepare specific Factory Acceptance Test (FAT) procedure, according ISO 15848 Part 2, and submit for PETROBRAS approval.

A.9.3.6.3. The “Tightness Class” shall be according:

Table A.62 – Tightness class for stem seals - fugitive emissions (ref.: ISO 15848 Part 1)

Tightness Class (Stem seals)	Measured Leak Rate ¹
A	≤ 50
B	≤ 100
C	≤ 1000
¹ Expressed in ppmv measured with the sniffing method as defined in ISO 15848 Part 1 - Annex B (1 ppmv = 1 ml/m ³ = 1 cm ³ /m ³)	

Table A.63 – Tightness class for body seals - fugitive emissions (ref.: ISO 15848 Part 1)

Measured concentration (Body seals)	≤ 50 ¹
¹ Expressed in ppmv measured with the sniffing method as defined in ISO 15848 Part 1 - Annex B (1 ppmv = 1 ml/m ³ = 1 cm ³ /m ³)	

A.9.3.6.4. The FAT report shall be according item 7 of ISO 15848 Part 1.

A.9.3.7. HIPPS VALVE IN PLACE TEST

A.9.3.7.1. All HIPPS valves shall be able to pass through a regular testing to demonstrate correct function and monitoring operating status. The test interval shall be consistent with the basis of the SIL analysis.

A.9.3.7.2. Following are the minimum considerations that shall be verified during in place test of a HIPPS valve:

- Regular Pressure/Leak Integrity Testing: The HIPPS shall be capable of demonstrating that the system has sufficient integrity to contain SIP with leakage less than the maximum leak rate. Testing interval will be determined by SIL rating or regulatory requirement.
- Maximum Leak Rate Testing: The HIPPS design shall include appropriate methods to measure or infer the leak rate of the HIPPS for comparison to the predetermined maximum leak rate. Maximum leak rate determination shall consider both short-term shutdown events and long-term shutdown events such as a storm shut-in and shall either be set by the operator or by regulatory requirement.

- c) Partial Stroke Testing (PST): Each valve shall be supplied with a dedicated Partial Stroke Test (PST) system installed inside the local control valve cabinet. Required Partial Stroke Test shall be implemented using devices specifically designed and certified for that purpose. PST shall be considered as a functional test which covers only a fraction of the possible failures, and not as self-test with diagnostic coverage. The fraction detected shall be properly documented. As minimum, the following tests shall be scope of the PST:
- 4 actuations of HIPPS valves under operational condition, with nominal line pressure in upstream, downstream and body cavity;
 - 4 actuations of HIPPS valves under DBB condition, direction open to close. In this case the valve should be at opened position, with nominal line pressure in the bore and without pressure in the cavity;
 - 4 actuations of HIPPS valves under DBB condition, direction close to open. In this case the valve should be at closed position, with nominal line pressure in upstream and downstream, and without pressure in the cavity;
 - For the FAT tests of the valve HIPPS, the sequence described herein shall be done considering the line pressure of 0% PMT, 50% PMT and 100% PMT.

NOTE: The results of the PST shall be registered using a statistical analysis (i.e.: average, standard deviation), in order to serve as a reference for the commissioning test and periodical test. Also, a failure mode effects and criticality analysis (e.g.: FMECA) shall be considered to be used.

A.10. HANDLING, STORING & SHIPPING

A.10.1. The manufacturer shall present a tested/validated procedure by laboratory performance for the preservation system and a procedure with handling, storing, packaging and shipping the valve (including actuator and positioner - electric/electronic parts).

A.10.2. After hydrostatic test, all valves shall be purged with dry compressed air, in the fully open position, until they are completely dry.

A.10.3. After purge, the valve shall be kept closed or opened, according to manufacturer instruction, inner protected with VCI for all the parts and no corrosion protector that will need any solvent to be removed may be used.

A.10.4. Valves with corrosion resistant materials needs the corrosion inhibitor for liquid and vapor phase added on the water, but do not need the use of VCI. Corrosion protector that will need any solvent to be removed shall not be used.

A.10.5. Valves made of brass, stainless steel and other non-oxidizable metal alloys shall receive protection against dust and moisture.

A.10.6. Small sized valves may be shipped inside a collective package. Even that, each valve shall be individually package prior to assembly the collective package.

A.10.7. Medium valves shall have an individual package.

A.10.8. Large valves shall be packed limited to their nozzles considering that they are protected by the painting.

A.10.9. The valves may be packed on upright or horizontal position, on open or closed position, according manufacturer recommendation.

A.11. DOCUMENTATION

A.11.1. DOCUMENTATION FORMATS & QUALITY

A.11.1.1. Whenever is possible (e.g.: a supply from a Brazilian manufacturer) all documentation shall be delivered in Portuguese (pt-BR). An alternative language to be considered for the documentation shall be English (e.g.: supply from an international manufacturer). Any deviation shall be requested and approved by PETROBRAS in advance of the delivery.

A.11.1.2. Typically, the format for the documents shall be Adobe Acrobat PDF (*.PDF). Other formats shall be agreed with PETROBRAS.

A.11.1.3. All documentation shall be of good quality with maximum legibility. Scanned images shall be checked before submittal for proper image quality, skewness and completeness.

A.11.2. DATA BOOK

A.11.2.1. The Data Book shall be filled in a manner which will facilitate rapid retrieval of information. They shall be made available to PETROBRAS, if required, for at least 5 years following the commencement of the guarantee period of last batch commercialized.

A.11.2.2. The Data Book shall represent the manufacturer's compilation of calculations together with the necessary drawings, manufacturing, testing and inspection procedures, certificates, personnel qualifications, non-conformance reports, records and reports required to demonstrate that the valve and actuator is in compliance with PETROBRAS's requirements.

A.11.2.3. It shall include, as minimum:

- a) Material certificates of compliance;
- b) ITP copy approved by PETROBRAS or EPC purchaser;
- c) Copy of all reports issued by the company responsible for inspection;
- d) WPS and WPQR for structural welding;
- e) Repair weld maps;
- f) NDT reports with lists of welder and NDT operator qualifications and procedures, and drawings of critical areas for NDT;
- g) Relevant fabrication drawings;
- h) Reports of non-compliance and corrective actions taken;
- i) FAT procedure and test results.
- j) Actuator certificate;
- k) Positioner certificate;
- l) Fire-test certificate, when applicable;
- m) Fugitive emission certificate, when applicable;

n) Inspection final report for shipment.

A.11.2.4. The issue of certificates shall be according EN 10204 type 2.2 for parts with no risk for environment as: hard welding deposit, closures, seal, springs and so on.

A.11.2.5. The issue of certificates shall be according EN 10204 type 3.1 for parts with risk for environment as: body, bonnet, cover, stem, studs/bolts, etc.

A.11.2.6. The Data Book shall be issued one per valve or one per purchase order (with traceability for valves groups). One hard copy of the Data Book shall be sent with the valve to final destination and an electronic copy shall be sent to the PURCHASER.

A.11.2.7. All material certificates shall be identified with: valve serial number, project name (when applicable), purchase order number, order item number, VDS number or project number.

A.11.3. USER MANUAL

A.11.3.1. The User Manual shall in an organized manner, give sufficient information in order to enable operation and maintenance of the valve in a safe, economical and functionally correct manner during all phases after installation.

A.11.3.2. The User Manual shall cover valve and actuator.

A.11.3.3. All documents shall be updated to "as-built".

A.11.4. DOCUMENTATION OF PRESERVATION, PROTECTION AND PACKING

A.11.4.1. The manufacturer shall prepare and submit procedure(s) for PETROBRAS approval, showing the following:

- a) description of the initial preservation/protection/packing carried out by the manufacturer prior to shipment:
 - The procedure shall also specify type of preservatives/ lubricants used, with technical data, handling and safety instructions, especially giving details of any chemical substances used that may be hazardous to personnel or environment.
- b) description of re-preservation after incoming inspection at end destination:
 - Preservation maintenance is to be carried out by the user during storage, installation and in the period prior to start-up for the intended use.
- c) unpacking and removal of protective devices and preservatives prior to operation:
 - The procedure shall indicate the proposed lifting methods for the valve and actuator, and all additional measures that shall be observed prior to and during installation.

A.11.4.2. The documentation of preservation, protection and packing shall fulfill all requirements stated on item A.10.

A.11.5. VALVE CODE

A.11.5.1. DESCRIPTION

A.11.5.1.1. All valves specified for application in Exploration and Production (E&P) oil production and process facilities have a unique code, in order to have uniformity and to systematize the coding of valves so that they can be handled in

an organized manner and information can be easily retrieved.

A.11.5.1.2. The complete structure of all valve codes shall be as follows:

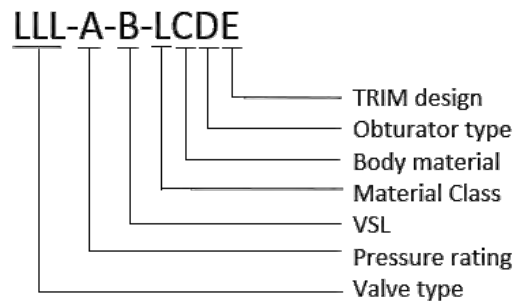

A.11.5.2. BASIC STRUCTURE OF A VALVE CODE

A.11.5.2.1. The valve code shall be made up of 2 basic groups ordered as follows:

Group 0	Group 1	Group 2
Valve Type	Pressure Rating	VSL
LLL	A	B

Where:

L is a letter;

A, B are numbers.

A.11.5.3. CONCECPT OF BASIC GROUPS

A.11.5.3.1. IDENTIFICATION OF VALVE TYPE (GROUP 0)

A.11.5.3.1.1. This is the basic group that identifies the type of the valve.

A.11.5.3.1.2. This group is comprised of three letters and its configuration is illustrated as follows:

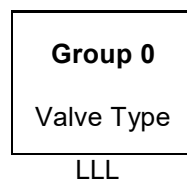

A.11.5.3.1.3. The following characters shall be used to distinguish the type of the valve:

- VAG – Needle valve
- VAX – Axial valve
- VBO – Butterfly valve
- VDE – Double Ball valve
- VDI – Diaphragm valve
- VES – Ball valve
- VGA – Gate valve
- VGL – Globe valve
- VMA – Plug valve

VRE – Check valve

A.11.5.3.2. IDENTIFICATION OF PRESSURE RATING (GROUP 1)

A.11.5.3.2.1. This is the basic group that identifies the pressure rating of the valve.

A.11.5.3.2.2. This group is comprised at least of three and maximum of 5 numbers and its configuration is illustrated as follows:

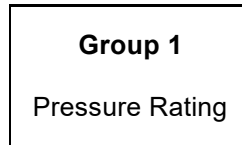

A

A.11.5.3.2.3. The following characters shall be used to distinguish the pressure rating of the valve:

- 125 – ASME Class 125
- 150 – ASME Class 150
- 300 – ASME Class 300
- 600 – ASME Class 600
- 801 – ASME Class 800 with SCH 40S (for ball valves)
- 801 – ASME Class 800 with SW ends ASME B16.11 (for gate valves)
- 802 – ASME Class 800 with SCH 80
- 803 – ASME Class 800 with SCH 160
- 804 – ASME Class 800 with SCH XXS
- 900 – ASME Class 900
- 1500 – ASME Class 1500
- 1501 – ASME Class 1500 with SCH 40S (for ball vales)
- 1501 – ASME Class 1500 with SW ends ASME B16.11 (for gate valves)
- 1502 – ASME Class 1500 with SCH 80
- 1503 – ASME Class 1500 with SCH 160
- 1504 – ASME Class 1500 with SCH XXS
- 2500 – ASME Class 2500
- 2501 – ASME Class 2500 with SCH 40S (for ball valves)
- 2501 – ASME Class 2500 with SW ends ASME B16.11 (for gate valves)
- 2502 – ASME Class 2500 with SCH 80
- 2503 – ASME Class 2500 with SCH 160
- 2504 – ASME Class 2500 with SCH XXS
- 3000 – Maximum Pressure 3.000 psi
- 5000 – Maximum Pressure 5.000 psi

6000 – Maximum Pressure 6.000 psi

10000 – Maximum Pressure 10.000 psi

A.11.5.3.3. IDENTIFICATION OF VSL (GROUP 2)

A.11.5.3.3.1. This is the basic group that identifies the VSL of the valve.

A.11.5.3.3.2. This group is comprised with one number and its configuration is illustrated as follows:

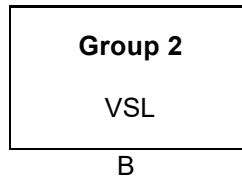

A.11.5.3.3.3. The following characters shall be used to distinguish the VSL of the valve:

- 1 – VSL-1
- 2 – VSL-2
- 3 – VSL-3
- 4 – VSL-4

A.11.5.4. SPECIFIC STRUCTURE OF A VALVE CODE

A.11.5.4.1. The valve code shall be made up of 4 specific groups ordered as follows:

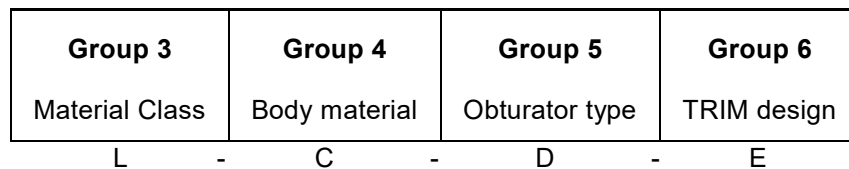

Where:

L is a letter;

C, D, E are numbers.

A.11.5.5. CONCECPT OF SPECIFIC GROUPS

A.11.5.5.1. IDENTIFICATION OF MATERIAL CLASS (GROUP 3)

A.11.5.5.1.1. This is the basic group that identifies the material class of the valve.

A.11.5.5.1.2. This group is comprised of one letter and its configuration is illustrated as follows:

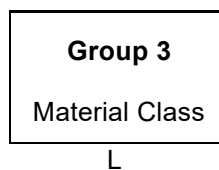

A.11.5.5.1.3. The following characters shall be used to distinguish the material class of the valve:

- C – Carbon steel
- A – Alloy Steel

S – Stainless steel

D – Duplex steel

N – Nickel alloy

U – Uncommon materials

A.11.5.5.2. IDENTIFICATION OF BODY MATERIAL (GROUP 4)

A.11.5.5.2.1. This is the basic group that identifies the body material of the valve.

A.11.5.5.2.2. This group is comprised of one number and its configuration is illustrated as follows:

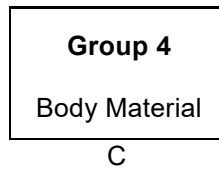

A.11.5.5.2.3. The following characters shall be used to distinguish the body material of the valve, related to the specific material class of the valve:

Table A.64 – Identification of body material code, according respective material class

(see next page)

Table A.64 – Identification of body material code, according respective material class

Body Material	Material Class					
	C	A	S	D	N	U
	Carbon steel	Alloy steel	Stainless steel	Duplex steel	Nickel alloys	Uncommon materials
1	ASTM A105 or ASTM A216 WCB	ASTM A350 LF3 or ASTM 352 LC3	ASTM A182 Gr. F304 or ASTM A351 Gr. CF8	ASTM A995 Gr. 1B	Inconel 625 (UNS N06625)	Bronze
2	A350 LF2 CL1 or ASTM A352 LCB	ASTM A182 F5	ASTM A182 Gr. F316 or ASTM A351 Gr. CF8M	ASTM A182 Gr. F51 or ASTM A995 Gr. 4A	-	ASTM A536-65-45-12
3	ASTM A105 or ASTM A216 WCB + Organic Coating (Onshore use only)	ASTM A182 F11 CL2	ASTM A182 Gr. F317 or ASTM A351 Gr. CG8M	ASTM A182 Gr. F55 or ASTM A995 Gr 6A	-	ASTM B148 (UNS C95800)
4	ASTM A105 or ASTM A216 WCB + Organic Coating (Offshore)	ASTM A522 Type I	ASTM A182 Gr. F347 or ASTM A351 Gr. CF8C	-	-	Plastics
5	ASTM A105 or ASTM A216 WCB + Inconel 625 overlay (UNS N06625)	ASTM A350 LF3 or ASTM A352 LC3 + Inconel 625 overlay (UNS N06625)	-	-	-	Gray Iron
6	ASTM A350 LF2 CL1 or ASTM A352 LCB + Inconel 625 overlay (UNS N06625)	ASTM A522 Type I + Inconel 625 overlay (UNS N06625)	-	-	-	-

A.11.5.5.3. IDENTIFICATION OF OBTURATOR TYPE (GROUP 5)

A.11.5.5.3.1. This is the basic group that identifies the obturator type of the valve.

A.11.5.5.3.2. This group is comprised of one number and its configuration is illustrated as follows:

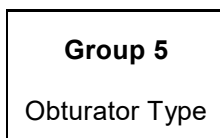

D

A.11.5.5.3.3. The following characters shall be used to distinguish the obturator type of the valve:

Table A.65 – Identification of obturator type, according valve type

Obturator type	Valve Type			
	Gate valve	Globe valve	Check Valve	Butterfly valve
0	Solid wedge	Bevelled disc	Piston	Category A (concentric)
1	Slab gate	Angular	Dual Plate	Category B Double offset (bi-eccentric)
2	Expanding gate	-	Swing	Category B Triple offset (tri-eccentric)
3	-	-	Axial non-slam	-
4	-	-	Ball	-

NOTE: For ball valves, the last two digits “D” and “E” in the valve code presents the configuration number of the valve, where:

DE – presents the basic configuration, according Table A.25 – for ball valves up to NPS 1 1/2 (“Forged” valves).

D - presents the selected group seal, according Table A.23 – for ball valves with NPS 2 and above;

E - presents the basic configuration, according Table A.26 – for ball valves with NPS 2 and above;

A.11.5.5.4. IDENTIFICATION OF TRIM DESIGN (GROUP 6)

A.11.5.5.4.1. This is the basic group that identifies the TRIM design of the valve.

A.11.5.5.4.2. This group is comprised of one number and its configuration is illustrated as follows:

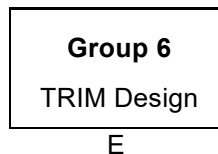

A.11.5.5.4.3. The following characters shall be used to distinguish the TRIM design of the valve:

Table A.66 – Identification of TRIM design, according valve type

TRIM design	Valve Type		
	Gate Globe	Check	Butterfly Category B
1	Standard TRIM	Soft TRIM	Wafer
2	Alternative TRIM	Metal x Metal TRIM	Lug
3	N/A	Alternative Metal x Metal TRIM	Double Flanged (Short Pattern)

Valve Type			
Butterfly Category A (Concentric)			
TRIM Config.	Lug	Wafer	Double Flanged (Short Pattern)
#1	1	2	3
#2	4	5	6
#3	7	8	9

NOTE: For ball valves, the last two digits “D” and “E” in the valve code presents the configuration number of the valve, where:

DE – presents the basic configuration, according Table A.25 – for ball valves up to NPS 1 1/2 (“Forged” valves).

E - presents the basic configuration, according Table A.26 – for ball valves with NPS 2 and above;

A.11.5.5.5. EXAMPLE OF VALVE CODE

A.11.5.5.5.1. Example 1

Gate valve, pressure rating class 900, VSL-2, material class of carbon steel, solid wedge, using standard TRIM:

VGA-900-2-C101

Valve Type: VGA – Gate valve

Pressure Rating: 900 – Class 900

VSL: 2 – VSL-2

Material Class: C – Carbon steel

Body Material: 1 – ASTM A105 or ASTM A216 WCB

Obturator type: 0 – Solid wedge

Trim design: 1 – Standard TRIM

A.11.5.5.5.2. Example 2

Ball valve, pressure rating 1500, VSL-2, material class of carbon steel, configuration 04 with nipple SCH XXS:

VES-1504-2-C207

Valve Type: VES – Ball valve

Pressure Rating: 1504 – ASME Class 1500 with SCH XXS

VSL: 2 – VSL-2

Material Class: C – Carbon steel

Body Material: 2 – A350 LF2 CL1 or ASTM A352 LCB

Configuration: 07 – Metal to metal ball valve with configuration according Table A.25

A.11.5.5.5.3. Example 3

Ball valve, pressure rating 2500, VSL-3, material class of super duplex, soft sealing, fire tested, DIB-2:

VES-2500-3-D339

Valve Type: VES – Ball valve

Pressure Rating: 2500 – ASME Class 2500

VSL: 3 – VSL-3

Material Class: D – Super duplex

Body Material: 3 – ASTM 182 Gr. F55

Seal Group: 3 – Groups D or E

Configuration: 9 – Soft sealing ball valve with configuration according Table A.26.

A.12. VALVE DATASHEET - VDS

A.12.2 BALL VALVES

Valve Code	VES-10000-2-D334	VES-1500-1-C114	VES-1500-1-C134	VES-1500-1-C150
Specs	J12P J12	G10P	G10P	G10P
1. Valve Type	Ball	Ball	Ball	Ball
2. Sealing Type	Soft	Soft	Soft	Metal to Metal
3. Valve Specification Level (VSL)	VSL-2	VSL-1	VSL-1	VSL-1
4. Ball Mouting	Trunnion	Trunnion	Trunnion	Trunnion
5. Standard	API 6A	API 6D / IOGP S-562	API 6D / IOGP S-562	API 6D / IOGP S-562
6. Size Range (NPS)	1" - 2"	2" - 24"	2" - 24"	2" - 24"
7. End Connection	API 6A, 6BX	ASME B16.5, RTJ	ASME B16.5, RTJ	ASME B16.5, RTJ
8. Pressure Class	max. press 10000 psi	1500	1500	1500
9. Temperature	-50°C to 150°C	0°C to 150°C	0°C to 150°C	0°C to 150°C
10. Material Class	Duplex Steel	Carbon Steel	Carbon Steel	Carbon Steel
11. Body Material	ASTM A182 Gr F55	ASTM A105 + SS316 weld overlay (acc. item A.7.1.7.3)	ASTM A105 + SS316 weld overlay (acc. item A.7.1.7.3)	ASTM A105 + SS316 weld overlay (acc. item A.7.1.7.3)
12. Obturator Material	Super Duplex (UNS S32760)	AISI 410	AISI 410	AISI 410 + Tungsten carbide coating
13. Seat Material	Super Duplex (UNS S32760)	AISI 410	AISI 410	AISI 410 + Tungsten carbide coating
14. Seat Insert	PEEK	PEEK	PEEK	N/A
15. Spring (Seat) Material	UNS N07750	UNS N07750	UNS N07750	UNS N07750
16. Stem Material	ASTM A276 (UNS S32760)	ASTM A276 (UNS S41000)	ASTM A276 (UNS S41000)	ASTM A276 (UNS S41000)
17. Seat-Stem Seal	Group E (acc. item A.7.1.5.6)	Group B (acc. item A.7.1.5.6)	Group D (acc. item A.7.1.5.6)	Group A (acc. item A.7.1.5.6)
18. Operator Type	Gearbox	Gearbox	Gearbox	Gearbox
19. Additional Requirement	N/A	N/A	N/A	N/A
20. Seat Type	Side A: SPE / Side B: SPE; DBB	Side A: SPE / Side B: SPE; DBB	Side A: SPE / Side B: SPE; DBB	Side A: SPE / Side B: SPE
21. Bore Type	Full Bore	Full Bore	Full Bore	Full Bore
22. Body Construction	split body, bolted	split body, bolted	split body, bolted	split body, bolted
23. Cladding or Coating	N/A	Partial clad - SS316 weld overlay on all body sealing areas	Partial clad - SS316 weld overlay on all body sealing areas	Partial clad - SS316 weld overlay on all body sealing areas
24. Valve Testing	FAT according A.9.3	FAT according A.9.3	FAT according A.9.3	FAT according A.9.3
25. Notes	N/A	N/A	N/A	N/A

Valve Code	VES-1500-1-C160	VES-1500-1-C170	VES-1500-1-S214	VES-1500-1-S224
Specs	G10P	G10P	G3	G3
1. Valve Type	Ball	Ball	Ball	Ball
2. Sealing Type	Metal to Metal	Metal to Metal	Soft	Soft
3. Valve Specification Level (VSL)	VSL-1	VSL-1	VSL-1	VSL-1
4. Ball Mouting	Trunnion	Trunnion	Trunnion	Trunnion
5. Standard	API 6D	API 6D	API 6D / IOGP S-562	API 6D / IOGP S-562
6. Size Range (NPS)	2" - 24"	2" - 24"	2" - 16"	2" - 16"
7. End Connection	ASME B16.5, RTJ	ASME B16.5, RTJ	ASME B16.5, RTJ	ASME B16.5, RTJ
8. Pressure Class	1500	1500	1500	1500
9. Temperature	0°C to 210°C	0°C to 210°C	-30°C to 150°C	0°C to 150°C
10. Material Class	Carbon Steel	Carbon Steel	Stainless Steel	Stainless Steel
11. Body Material	ASTM A105 + SS316 weld overlay (acc. item A.7.1.7.3)	ASTM A105 + SS316 weld overlay (acc. item A.7.1.7.3)	ASTM A182 Gr F316	ASTM A182 Gr F316
12. Obturator Material	AISI 410 + Tungsten carbide coating	AISI 410 + Tungsten carbide coating	AISI 316	AISI 316
13. Seat Material	AISI 410 + Tungsten carbide coating	AISI 410 + Tungsten carbide coating	AISI 316	AISI 316
14. Seat Insert	N/A	N/A	PEEK	PEEK
15. Spring (Seat) Material	UNS N07750	UNS N07750	UNS N07750	UNS N07750
16. Stem Material	ASTM A276 (UNS S41000)	ASTM A276 (UNS S41000)	ASTM A276 (UNS S31803)	ASTM A276 (UNS S31803)
17. Seat-Stem Seal	Group C (acc. item A.7.1.5.6)	Group D (acc. item A.7.1.5.6)	Group B (acc. item A.7.1.5.6)	Group C (acc. item A.7.1.5.6)
18. Operator Type	Gearbox	Gearbox	Gearbox	Gearbox
19. Additional Requirement	N/A	N/A	N/A	N/A
20. Seat Type	Side A: SPE / Side B: SPE	Side A: SPE / Side B: SPE	Side A: SPE / Side B: SPE; DBB	Side A: SPE / Side B: SPE; DBB
21. Bore Type	Full Bore	Full Bore	Full Bore	Full Bore
22. Body Construction	split body, bolted	split body, bolted	split body, bolted	split body, bolted
23. Cladding or Coating	Partial clad - SS316 weld overlay on all body sealing areas	Partial clad - SS316 weld overlay on all body sealing areas	N/A	N/A
24. Valve Testing	FAT according A.9.3	FAT according A.9.3	FAT according A.9.3	FAT according A.9.3
25. Notes	N/A	N/A	N/A	N/A

Valve Code	VES-1500-1-S234	VES-1500-1-S250	VES-1500-1-S260	VES-1500-1-S270
Specs	G3	G3	G3	G3
1. Valve Type	Ball	Ball	Ball	Ball
2. Sealing Type	Soft	Metal to Metal	Metal to Metal	Metal to Metal
3. Valve Specification Level (VSL)	VSL-1	VSL-1	VSL-1	VSL-1
4. Ball Mouting	Trunnion	Trunnion	Trunnion	Trunnion
5. Standard	API 6D / IOGP S-562	API 6D / IOGP S-562	API 6D	API 6D
6. Size Range (NPS)	2" - 16"	2" - 16"	2" - 16"	2" - 16"
7. End Connection	ASME B16.5, RTJ	ASME B16.5, RTJ	ASME B16.5, RTJ	ASME B16.5, RTJ
8. Pressure Class	1500	1500	1500	1500
9. Temperature	-46°C to 150°C	-30°C to 150°C	0°C to 210°C	-100°C to 200°C
10. Material Class	Stainless Steel	Stainless Steel	Stainless Steel	Stainless Steel
11. Body Material	ASTM A182 Gr F316	ASTM A182 Gr F316	ASTM A182 Gr F316	ASTM A182 Gr F316
12. Obturator Material	AISI 316	AISI 316 + Tungsten carbide coating	AISI 316 + Tungsten carbide coating	AISI 316 + Tungsten carbide coating
13. Seat Material	AISI 316	AISI 316 + Tungsten carbide coating	AISI 316 + Tungsten carbide coating	AISI 316 + Tungsten carbide coating
14. Seat Insert	PEEK	N/A	N/A	N/A
15. Spring (Seat) Material	UNS N07750	UNS N07750	UNS N07750	UNS N07750
16. Stem Material	ASTM A276 (UNS S31803)	ASTM A276 (UNS S31803)	ASTM A276 (UNS S31803)	ASTM B637 (UNS N07718)
17. Seat-Stem Seal	Group E (acc. item A.7.1.5.6)	Group B (acc. item A.7.1.5.6)	Group C (acc. item A.7.1.5.6)	Group E (acc. item A.7.1.5.6)
18. Operator Type	Gearbox	Gearbox	Gearbox	Gearbox
19. Additional Requirement	N/A	N/A	N/A	N/A
20. Seat Type	Side A: SPE / Side B: SPE; DBB	Side A: SPE / Side B: SPE	Side A: SPE / Side B: SPE	Side A: SPE / Side B: SPE
21. Bore Type	Full Bore	Full Bore	Full Bore	Full Bore
22. Body Construction	split body, bolted	split body, bolted	split body, bolted	split body, bolted
23. Cladding or Coating	N/A	N/A	N/A	N/A
24. Valve Testing	FAT according A.9.3	FAT according A.9.3	FAT according A.9.3	FAT according A.9.3
25. Notes	N/A	N/A	N/A	N/A

Valve Code	VES-1500-2-C114	VES-1500-2-C118	VES-1500-2-C134	VES-1500-2-C138
Specs	G10P	G10P	G10P	G10P
1. Valve Type	Ball	Ball	Ball	Ball
2. Sealing Type	Soft	Soft	Soft	Soft
3. Valve Specification Level (VSL)	VSL-2	VSL-2	VSL-2	VSL-2
4. Ball Mouting	Trunnion	Trunnion	Trunnion	Trunnion
5. Standard	API 6D / IOGP S-562	API 6D / IOGP S-562	API 6D / IOGP S-562	API 6D / IOGP S-562
6. Size Range (NPS)	2" - 24"	2" - 24"	2" - 24"	2" - 24"
7. End Connection	ASME B16.5, RTJ	ASME B16.5, RTJ	ASME B16.5, RTJ	ASME B16.5, RTJ
8. Pressure Class	1500	1500	1500	1500
9. Temperature	0°C to 150°C	0°C to 150°C	0°C to 150°C	0°C to 150°C
10. Material Class	Carbon Steel	Carbon Steel	Carbon Steel	Carbon Steel
11. Body Material	ASTM A105 + SS316 weld overlay (acc. item A.7.1.7.3)	ASTM A105 + SS316 weld overlay (acc. item A.7.1.7.3)	ASTM A105 + SS316 weld overlay (acc. item A.7.1.7.3)	ASTM A105 + SS316 weld overlay (acc. item A.7.1.7.3)
12. Obturator Material	AISI 410	AISI 410	AISI 410	AISI 410
13. Seat Material	AISI 410	AISI 410	AISI 410	AISI 410
14. Seat Insert	PEEK	PEEK	PEEK	PEEK
15. Spring (Seat) Material	UNS N07750	UNS N07750	UNS N07750	UNS N07750
16. Stem Material	ASTM A276 (UNS S41000)	ASTM A276 (UNS S41000)	ASTM A276 (UNS S41000)	ASTM A276 (UNS S41000)
17. Seat-Stem Seal	Group B (acc. item A.7.1.5.6)	Group B (acc. item A.7.1.5.6)	Group D (acc. item A.7.1.5.6)	Group D (acc. item A.7.1.5.6)
18. Operator Type	Gearbox	Gearbox	Gearbox	Gearbox
19. Additional Requirement	N/A	N/A	N/A	N/A
20. Seat Type	Side A: SPE / Side B: SPE; DBB	Side A: SPE / Side B: DPE; DIB-2 & DBB	Side A: SPE / Side B: SPE; DBB	Side A: SPE / Side B: DPE; DIB-2 & DBB
21. Bore Type	Full Bore	Full Bore	Full Bore	Full Bore
22. Body Construction	split body, bolted	split body, bolted	split body, bolted	split body, bolted
23. Cladding or Coating	Partial clad - SS316 weld overlay on all body sealing areas	Partial clad - SS316 weld overlay on all body sealing areas	Partial clad - SS316 weld overlay on all body sealing areas	Partial clad - SS316 weld overlay on all body sealing areas
24. Valve Testing	FAT according A.9.3	FAT according A.9.3	FAT according A.9.3	FAT according A.9.3
25. Notes	N/A	N/A	N/A	N/A

Valve Code	VES-1500-2-C150	VES-1500-2-C152	VES-1500-2-C160	VES-1500-2-C162
Specs	G10P	G10P	G10P	G10P
1. Valve Type	Ball	Ball	Ball	Ball
2. Sealing Type	Metal to Metal	Metal to Metal	Metal to Metal	Metal to Metal
3. Valve Specification Level (VSL)	VSL-2	VSL-2	VSL-2	VSL-2
4. Ball Mouting	Trunnion	Trunnion	Trunnion	Trunnion
5. Standard	API 6D / IOGP S-562	API 6D / IOGP S-562	API 6D	API 6D
6. Size Range (NPS)	2" - 24"	2" - 24"	2" - 24"	2" - 24"
7. End Connection	ASME B16.5, RTJ	ASME B16.5, RTJ	ASME B16.5, RTJ	ASME B16.5, RTJ
8. Pressure Class	1500	1500	1500	1500
9. Temperature	0°C to 150°C	0°C to 150°C	0°C to 210°C	0°C to 210°C
10. Material Class	Carbon Steel	Carbon Steel	Carbon Steel	Carbon Steel
11. Body Material	ASTM A105 + SS316 weld overlay (acc. item A.7.1.7.3)	ASTM A105 + SS316 weld overlay (acc. item A.7.1.7.3)	ASTM A105 + SS316 weld overlay (acc. item A.7.1.7.3)	ASTM A105 + SS316 weld overlay (acc. item A.7.1.7.3)
12. Obturator Material	AISI 410 + Tungsten carbide coating	AISI 410 + Tungsten carbide coating	AISI 410 + Tungsten carbide coating	AISI 410 + Tungsten carbide coating
13. Seat Material	AISI 410 + Tungsten carbide coating	AISI 410 + Tungsten carbide coating	AISI 410 + Tungsten carbide coating	AISI 410 + Tungsten carbide coating
14. Seat Insert	N/A	N/A	N/A	N/A
15. Spring (Seat) Material	UNS N07750	UNS N07750	UNS N07750	UNS N07750
16. Stem Material	ASTM A276 (UNS S41000)	ASTM A276 (UNS S41000)	ASTM A276 (UNS S41000)	ASTM A276 (UNS S41000)
17. Seat-Stem Seal	Group A (acc. item A.7.1.5.6)	Group A (acc. item A.7.1.5.6)	Group C (acc. item A.7.1.5.6)	Group C (acc. item A.7.1.5.6)
18. Operator Type	Gearbox	Gearbox	Gearbox	Gearbox
19. Additional Requirement	N/A	N/A	N/A	N/A
20. Seat Type	Side A: SPE / Side B: SPE	Side A: SPE / Side B: DPE; DIB-2 & DBB	Side A: SPE / Side B: SPE	Side A: SPE / Side B: DPE; DIB-2 & DBB
21. Bore Type	Full Bore	Full Bore	Full Bore	Full Bore
22. Body Construction	split body, bolted	split body, bolted	split body, bolted	split body, bolted
23. Cladding or Coating	Partial clad - SS316 weld overlay on all body sealing areas	Partial clad - SS316 weld overlay on all body sealing areas	Partial clad - SS316 weld overlay on all body sealing areas	Partial clad - SS316 weld overlay on all body sealing areas
24. Valve Testing	FAT according A.9.3	FAT according A.9.3	FAT according A.9.3	FAT according A.9.3
25. Notes	N/A	N/A	N/A	N/A

Valve Code	VES-1500-2-C170	VES-1500-2-C172	VES-1500-2-S214	VES-1500-2-S218
Specs	G10P	G10P	G3	G3
1. Valve Type	Ball	Ball	Ball	Ball
2. Sealing Type	Metal to Metal	Metal to Metal	Soft	Soft
3. Valve Specification Level (VSL)	VSL-2	VSL-2	VSL-2	VSL-2
4. Ball Mouting	Trunnion	Trunnion	Trunnion	Trunnion
5. Standard	API 6D	API 6D	API 6D / IOGP S-562	API 6D / IOGP S-562
6. Size Range (NPS)	2" - 24"	2" - 24"	2" - 16"	2" - 16"
7. End Connection	ASME B16.5, RTJ	ASME B16.5, RTJ	ASME B16.5, RTJ	ASME B16.5, RTJ
8. Pressure Class	1500	1500	1500	1500
9. Temperature	0°C to 210°C	0°C to 210°C	-30°C to 150°C	-30°C to 150°C
10. Material Class	Carbon Steel	Carbon Steel	Stainless Steel	Stainless Steel
11. Body Material	ASTM A105 + SS316 weld overlay (acc. item A.7.1.7.3)	ASTM A105 + SS316 weld overlay (acc. item A.7.1.7.3)	ASTM A182 Gr F316	ASTM A182 Gr F316
12. Obturator Material	AISI 410 + Tungsten carbide coating	AISI 410 + Tungsten carbide coating	AISI 316	AISI 316
13. Seat Material	AISI 410 + Tungsten carbide coating	AISI 410 + Tungsten carbide coating	AISI 316	AISI 316
14. Seat Insert	N/A	N/A	PEEK	PEEK
15. Spring (Seat) Material	UNS N07750	UNS N07750	UNS N07750	UNS N07750
16. Stem Material	ASTM A276 (UNS S41000)	ASTM A276 (UNS S41000)	ASTM A276 (UNS S31803)	ASTM A276 (UNS S31803)
17. Seat-Stem Seal	Group D (acc. item A.7.1.5.6)	Group D (acc. item A.7.1.5.6)	Group B (acc. item A.7.1.5.6)	Group B (acc. item A.7.1.5.6)
18. Operator Type	Gearbox	Gearbox	Gearbox	Gearbox
19. Additional Requirement	N/A	N/A	N/A	N/A
20. Seat Type	Side A: SPE / Side B: SPE	Side A: SPE / Side B: DPE; DIB-2 & DBB	Side A: SPE / Side B: SPE; DBB	Side A: SPE / Side B: DPE; DIB-2 & DBB
21. Bore Type	Full Bore	Full Bore	Full Bore	Full Bore
22. Body Construction	split body, bolted	split body, bolted	split body, bolted	split body, bolted
23. Cladding or Coating	Partial clad - SS316 weld overlay on all body sealing areas	Partial clad - SS316 weld overlay on all body sealing areas	N/A	N/A
24. Valve Testing	FAT according A.9.3	FAT according A.9.3	FAT according A.9.3	FAT according A.9.3
25. Notes	N/A	N/A	N/A	N/A

Valve Code	VES-1500-2-S224	VES-1500-2-S228	VES-1500-2-S234	VES-1500-2-S238
Specs	G3	G3	G3	G3
1. Valve Type	Ball	Ball	Ball	Ball
2. Sealing Type	Soft	Soft	Soft	Soft
3. Valve Specification Level (VSL)	VSL-2	VSL-2	VSL-2	VSL-2
4. Ball Mouting	Trunnion	Trunnion	Trunnion	Trunnion
5. Standard	API 6D / IOGP S-562	API 6D / IOGP S-562	API 6D / IOGP S-562	API 6D / IOGP S-562
6. Size Range (NPS)	2" - 16"	2" - 16"	2" - 16"	2" - 16"
7. End Connection	ASME B16.5, RTJ	ASME B16.5, RTJ	ASME B16.5, RTJ	ASME B16.5, RTJ
8. Pressure Class	1500	1500	1500	1500
9. Temperature	0°C to 150°C	0°C to 150°C	-46°C to 150°C	-46°C to 150°C
10. Material Class	Stainless Steel	Stainless Steel	Stainless Steel	Stainless Steel
11. Body Material	ASTM A182 Gr F316	ASTM A182 Gr F316	ASTM A182 Gr F316	ASTM A182 Gr F316
12. Obturator Material	AISI 316	AISI 316	AISI 316	AISI 316
13. Seat Material	AISI 316	AISI 316	AISI 316	AISI 316
14. Seat Insert	PEEK	PEEK	PEEK	PEEK
15. Spring (Seat) Material	UNS N07750	UNS N07750	UNS N07750	UNS N07750
16. Stem Material	ASTM A276 (UNS S31803)	ASTM A276 (UNS S31803)	ASTM A276 (UNS S31803)	ASTM A276 (UNS S31803)
17. Seat-Stem Seal	Group C (acc. item A.7.1.5.6)	Group C (acc. item A.7.1.5.6)	Group E (acc. item A.7.1.5.6)	Group E (acc. item A.7.1.5.6)
18. Operator Type	Gearbox	Gearbox	Gearbox	Gearbox
19. Additional Requirement	N/A	N/A	N/A	N/A
20. Seat Type	Side A: SPE / Side B: SPE; DBB	Side A: SPE / Side B: DPE; DIB-2 & DBB	Side A: SPE / Side B: SPE; DBB	Side A: SPE / Side B: DPE; DIB-2 & DBB
21. Bore Type	Full Bore	Full Bore	Full Bore	Full Bore
22. Body Construction	split body, bolted	split body, bolted	split body, bolted	split body, bolted
23. Cladding or Coating	N/A	N/A	N/A	N/A
24. Valve Testing	FAT according A.9.3	FAT according A.9.3	FAT according A.9.3	FAT according A.9.3
25. Notes	N/A	N/A	N/A	N/A

Valve Code	VES-1500-2-S250	VES-1500-2-S252	VES-1500-2-S260	VES-1500-2-S262
Specs	G3	G3	G3	G3
1. Valve Type	Ball	Ball	Ball	Ball
2. Sealing Type	Metal to Metal	Metal to Metal	Metal to Metal	Metal to Metal
3. Valve Specification Level (VSL)	VSL-2	VSL-2	VSL-2	VSL-2
4. Ball Mouting	Trunnion	Trunnion	Trunnion	Trunnion
5. Standard	API 6D / IOGP S-562	API 6D / IOGP S-562	API 6D	API 6D
6. Size Range (NPS)	2" - 16"	2" - 16"	2" - 16"	2" - 16"
7. End Connection	ASME B16.5, RTJ	ASME B16.5, RTJ	ASME B16.5, RTJ	ASME B16.5, RTJ
8. Pressure Class	1500	1500	1500	1500
9. Temperature	-30°C to 150°C	-30°C to 150°C	0°C to 210°C	0°C to 210°C
10. Material Class	Stainless Steel	Stainless Steel	Stainless Steel	Stainless Steel
11. Body Material	ASTM A182 Gr F316	ASTM A182 Gr F316	ASTM A182 Gr F316	ASTM A182 Gr F316
12. Obturator Material	AISI 316 + Tungsten carbide coating	AISI 316 + Tungsten carbide coating	AISI 316 + Tungsten carbide coating	AISI 316 + Tungsten carbide coating
13. Seat Material	AISI 316 + Tungsten carbide coating	AISI 316 + Tungsten carbide coating	AISI 316 + Tungsten carbide coating	AISI 316 + Tungsten carbide coating
14. Seat Insert	N/A	N/A	N/A	N/A
15. Spring (Seat) Material	UNS N07750	UNS N07750	UNS N07750	UNS N07750
16. Stem Material	ASTM A276 (UNS S31803)	ASTM A276 (UNS S31803)	ASTM A276 (UNS S31803)	ASTM A276 (UNS S31803)
17. Seat-Stem Seal	Group B (acc. item A.7.1.5.6)	Group B (acc. item A.7.1.5.6)	Group C (acc. item A.7.1.5.6)	Group C (acc. item A.7.1.5.6)
18. Operator Type	Gearbox	Gearbox	Gearbox	Gearbox
19. Additional Requirement	N/A	N/A	N/A	N/A
20. Seat Type	Side A: SPE / Side B: SPE	Side A: SPE / Side B: DPE; DIB-2 & DBB	Side A: SPE / Side B: SPE	Side A: SPE / Side B: DPE; DIB-2 & DBB
21. Bore Type	Full Bore	Full Bore	Full Bore	Full Bore
22. Body Construction	split body, bolted	split body, bolted	split body, bolted	split body, bolted
23. Cladding or Coating	N/A	N/A	N/A	N/A
24. Valve Testing	FAT according A.9.3	FAT according A.9.3	FAT according A.9.3	FAT according A.9.3
25. Notes	N/A	N/A	N/A	N/A

Valve Code	VES-1500-2-S270	VES-1500-2-S272	VES-1500-3-C118	VES-1500-3-C119
Specs	G3	G3	G10P	G10P
1. Valve Type	Ball	Ball	Ball	Ball
2. Sealing Type	Metal to Metal	Metal to Metal	Soft	Soft
3. Valve Specification Level (VSL)	VSL-2	VSL-2	VSL-3	VSL-3
4. Ball Mouting	Trunnion	Trunnion	Trunnion	Trunnion
5. Standard	API 6D	API 6D	API 6D / IOGP S-562	API 6D / IOGP S-562
6. Size Range (NPS)	2" - 16"	2" - 16"	2" - 24"	2" - 24"
7. End Connection	ASME B16.5, RTJ	ASME B16.5, RTJ	ASME B16.5, RTJ	ASME B16.5, RTJ
8. Pressure Class	1500	1500	1500	1500
9. Temperature	-100°C to 200°C	-100°C to 200°C	-29°C to 150°C	-29°C to 150°C
10. Material Class	Stainless Steel	Stainless Steel	Carbon Steel	Carbon Steel
11. Body Material	ASTM A182 Gr F316	ASTM A182 Gr F316	ASTM A105 + SS316 weld overlay (acc. item A.7.1.7.3)	ASTM A105 + SS316 weld overlay (acc. item A.7.1.7.3)
12. Obturator Material	AISI 316 + Tungsten carbide coating	AISI 316 + Tungsten carbide coating	AISI 410	AISI 410
13. Seat Material	AISI 316 + Tungsten carbide coating	AISI 316 + Tungsten carbide coating	AISI 410	AISI 410
14. Seat Insert	N/A	N/A	PEEK	PEEK
15. Spring (Seat) Material	UNS N07750	UNS N07750	UNS N07750	UNS N07750
16. Stem Material	ASTM B637 (UNS N07718)	ASTM B637 (UNS N07718)	ASTM A276 (UNS S41000)	ASTM A276 (UNS S41000)
17. Seat-Stem Seal	Group E (acc. item A.7.1.5.6)	Group E (acc. item A.7.1.5.6)	Group B (acc. item A.7.1.5.6)	Group B (acc. item A.7.1.5.6)
18. Operator Type	Gearbox	Gearbox	Gearbox	Gearbox
19. Additional Requirement	N/A	N/A	N/A	Fire Tested (acc. item A.6.1.4)
20. Seat Type	Side A: SPE / Side B: SPE	Side A: SPE / Side B: DPE; DIB-2 & DBB	Side A: SPE / Side B: DPE; DIB-2 & DBB	Side A: SPE / Side B: DPE; DIB-2 & DBB
21. Bore Type	Full Bore	Full Bore	Full Bore	Full Bore
22. Body Construction	split body, bolted	split body, bolted	split body, bolted	split body, bolted
23. Cladding or Coating	N/A	N/A	Partial clad - SS316 weld overlay on all body sealing areas	Partial clad - SS316 weld overlay on all body sealing areas
24. Valve Testing	FAT according A.9.3	FAT according A.9.3	FAT according A.9.3	FAT according A.9.3
25. Notes	N/A	N/A	N/A	N/A

Valve Code	VES-1500-3-C138	VES-1500-3-C139	VES-1500-3-C152	VES-1500-3-C153
Specs	G10P	G10P	G10P	G10P
1. Valve Type	Ball	Ball	Ball	Ball
2. Sealing Type	Soft	Soft	Metal to Metal	Metal to Metal
3. Valve Specification Level (VSL)	VSL-3	VSL-3	VSL-3	VSL-3
4. Ball Mouting	Trunnion	Trunnion	Trunnion	Trunnion
5. Standard	API 6D / IOGP S-562	API 6D / IOGP S-562	API 6D / IOGP S-562	API 6D / IOGP S-562
6. Size Range (NPS)	2" - 24"	2" - 24"	2" - 24"	2" - 24"
7. End Connection	ASME B16.5, RTJ	ASME B16.5, RTJ	ASME B16.5, RTJ	ASME B16.5, RTJ
8. Pressure Class	1500	1500	1500	1500
9. Temperature	0°C to 150°C	-29°C to 150°C	0°C to 150°C	-29°C to 150°C
10. Material Class	Carbon Steel	Carbon Steel	Carbon Steel	Carbon Steel
11. Body Material	ASTM A105 + SS316 weld overlay (acc. item A.7.1.7.3)	ASTM A105 + SS316 weld overlay (acc. item A.7.1.7.3)	ASTM A105 + SS316 weld overlay (acc. item A.7.1.7.3)	ASTM A105 + SS316 weld overlay (acc. item A.7.1.7.3)
12. Obturator Material	AISI 410	AISI 410	AISI 410 + Tungsten carbide coating	AISI 410 + Tungsten carbide coating
13. Seat Material	AISI 410	AISI 410	AISI 410 + Tungsten carbide coating	AISI 410 + Tungsten carbide coating
14. Seat Insert	PEEK	PEEK	N/A	N/A
15. Spring (Seat) Material	UNS N07750	UNS N07750	UNS N07750	UNS N07750
16. Stem Material	ASTM A276 (UNS S41000)	ASTM A276 (UNS S41000)	ASTM A276 (UNS S41000)	ASTM A276 (UNS S41000)
17. Seat-Stem Seal	Group D (acc. item A.7.1.5.6)	Group E (acc. item A.7.1.5.6)	Group A (acc. item A.7.1.5.6)	Group B (acc. item A.7.1.5.6)
18. Operator Type	Gearbox	Gearbox	Gearbox	Gearbox
19. Additional Requirement	N/A	Fire Tested (acc. item A.6.1.4)	N/A	Fire Tested (acc. item A.6.1.4)
20. Seat Type	Side A: SPE / Side B: DPE; DIB-2 & DBB	Side A: SPE / Side B: DPE; DIB-2 & DBB	Side A: SPE / Side B: DPE; DIB-2 & DBB	Side A: SPE / Side B: DPE; DIB-2 & DBB
21. Bore Type	Full Bore	Full Bore	Full Bore	Full Bore
22. Body Construction	split body, bolted	split body, bolted	split body, bolted	split body, bolted
23. Cladding or Coating	Partial clad - SS316 weld overlay on all body sealing areas	Partial clad - SS316 weld overlay on all body sealing areas	Partial clad - SS316 weld overlay on all body sealing areas	Partial clad - SS316 weld overlay on all body sealing areas
24. Valve Testing	FAT according A.9.3	FAT according A.9.3	FAT according A.9.3	FAT according A.9.3
25. Notes	N/A	N/A	Acceptance criteria for sealing tests see Annex A	Acceptance criteria for sealing tests see Annex A

Valve Code	VES-1500-3-C162	VES-1500-3-C163	VES-1500-3-C172	VES-1500-3-C173
Specs	G10P	G10P	G10P	G10P
1. Valve Type	Ball	Ball	Ball	Ball
2. Sealing Type	Metal to Metal	Metal to Metal	Metal to Metal	Metal to Metal
3. Valve Specification Level (VSL)	VSL-3	VSL-3	VSL-3	VSL-3
4. Ball Mouting	Trunnion	Trunnion	Trunnion	Trunnion
5. Standard	API 6D	API 6D	API 6D	API 6D
6. Size Range (NPS)	2" - 24"	2" - 24"	2" - 24"	2" - 24"
7. End Connection	ASME B16.5, RTJ	ASME B16.5, RTJ	ASME B16.5, RTJ	ASME B16.5, RTJ
8. Pressure Class	1500	1500	1500	1500
9. Temperature	0°C to 210°C	0°C to 210°C	0°C to 210°C	-29°C to 200°C
10. Material Class	Carbon Steel	Carbon Steel	Carbon Steel	Carbon Steel
11. Body Material	ASTM A105 + SS316 weld overlay (acc. item A.7.1.7.3)	ASTM A105 + SS316 weld overlay (acc. item A.7.1.7.3)	ASTM A105 + SS316 weld overlay (acc. item A.7.1.7.3)	ASTM A105 + SS316 weld overlay (acc. item A.7.1.7.3)
12. Obturator Material	AISI 410 + Tungsten carbide coating	AISI 410 + Tungsten carbide coating	AISI 410 + Tungsten carbide coating	AISI 410 + Tungsten carbide coating
13. Seat Material	AISI 410 + Tungsten carbide coating	AISI 410 + Tungsten carbide coating	AISI 410 + Tungsten carbide coating	AISI 410 + Tungsten carbide coating
14. Seat Insert	N/A	N/A	N/A	N/A
15. Spring (Seat) Material	UNS N07750	UNS N07750	UNS N07750	UNS N07750
16. Stem Material	ASTM A276 (UNS S41000)	ASTM A276 (UNS S41000)	ASTM A276 (UNS S41000)	ASTM A276 (UNS S41000)
17. Seat-Stem Seal	Group C (acc. item A.7.1.5.6)	Group C (acc. item A.7.1.5.6)	Group D (acc. item A.7.1.5.6)	Group E (acc. item A.7.1.5.6)
18. Operator Type	Gearbox	Gearbox	Gearbox	Gearbox
19. Additional Requirement	N/A	Fire Tested (acc. item A.6.1.4)	N/A	Fire Tested (acc. item A.6.1.4)
20. Seat Type	Side A: SPE / Side B: DPE; DIB-2 & DBB	Side A: SPE / Side B: DPE; DIB-2 & DBB	Side A: SPE / Side B: DPE; DIB-2 & DBB	Side A: SPE / Side B: DPE; DIB-2 & DBB
21. Bore Type	Full Bore	Full Bore	Full Bore	Full Bore
22. Body Construction	split body, bolted	split body, bolted	split body, bolted	split body, bolted
23. Cladding or Coating	Partial clad - SS316 weld overlay on all body sealing areas	Partial clad - SS316 weld overlay on all body sealing areas	Partial clad - SS316 weld overlay on all body sealing areas	Partial clad - SS316 weld overlay on all body sealing areas
24. Valve Testing	FAT according A.9.3	FAT according A.9.3	FAT according A.9.3	FAT according A.9.3
25. Notes	Acceptance criteria for sealing tests see Annex A	Acceptance criteria for sealing tests see Annex A	Acceptance criteria for sealing tests see Annex A	Acceptance criteria for sealing tests see Annex A

Valve Code	VES-1500-3-S218	VES-1500-3-S219	VES-1500-3-S228	VES-1500-3-S229
Specs	G3	G3	G3	G3
1. Valve Type	Ball	Ball	Ball	Ball
2. Sealing Type	Soft	Soft	Soft	Soft
3. Valve Specification Level (VSL)	VSL-3	VSL-3	VSL-3	VSL-3
4. Ball Mouting	Trunnion	Trunnion	Trunnion	Trunnion
5. Standard	API 6D / IOGP S-562	API 6D / IOGP S-562	API 6D / IOGP S-562	API 6D / IOGP S-562
6. Size Range (NPS)	2" - 16"	2" - 16"	2" - 16"	2" - 16"
7. End Connection	ASME B16.5, RTJ	ASME B16.5, RTJ	ASME B16.5, RTJ	ASME B16.5, RTJ
8. Pressure Class	1500	1500	1500	1500
9. Temperature	-30°C to 150°C	-30°C to 150°C	0°C to 150°C	0°C to 150°C
10. Material Class	Stainless Steel	Stainless Steel	Stainless Steel	Stainless Steel
11. Body Material	ASTM A182 Gr F316	ASTM A182 Gr F316	ASTM A182 Gr F316	ASTM A182 Gr F316
12. Obturator Material	AISI 316	AISI 316	AISI 316	AISI 316
13. Seat Material	AISI 316	AISI 316	AISI 316	AISI 316
14. Seat Insert	PEEK	PEEK	PEEK	PEEK
15. Spring (Seat) Material	UNS N07750	UNS N07750	UNS N07750	UNS N07750
16. Stem Material	ASTM A276 (UNS S31803)	ASTM A276 (UNS S31803)	ASTM A276 (UNS S31803)	ASTM A276 (UNS S31803)
17. Seat-Stem Seal	Group B (acc. item A.7.1.5.6)	Group B (acc. item A.7.1.5.6)	Group C (acc. item A.7.1.5.6)	Group C (acc. item A.7.1.5.6)
18. Operator Type	Gearbox	Gearbox	Gearbox	Gearbox
19. Additional Requirement	N/A	Fire Tested (acc. item A.6.1.4)	N/A	Fire Tested (acc. item A.6.1.4)
20. Seat Type	Side A: SPE / Side B: DPE; DIB-2 & DBB	Side A: SPE / Side B: DPE; DIB-2 & DBB	Side A: SPE / Side B: DPE; DIB-2 & DBB	Side A: SPE / Side B: DPE; DIB-2 & DBB
21. Bore Type	Full Bore	Full Bore	Full Bore	Full Bore
22. Body Construction	split body, bolted	split body, bolted	split body, bolted	split body, bolted
23. Cladding or Coating	N/A	N/A	N/A	N/A
24. Valve Testing	FAT according A.9.3	FAT according A.9.3	FAT according A.9.3	FAT according A.9.3
25. Notes	N/A	N/A	N/A	N/A

Valve Code	VES-1500-3-S238	VES-1500-3-S239	VES-1500-3-S252	VES-1500-3-S253
Specs	G3	G3	G3	G3
1. Valve Type	Ball	Ball	Ball	Ball
2. Sealing Type	Soft	Soft	Metal to Metal	Metal to Metal
3. Valve Specification Level (VSL)	VSL-3	VSL-3	VSL-3	VSL-3
4. Ball Mouting	Trunnion	Trunnion	Trunnion	Trunnion
5. Standard	API 6D / IOGP S-562	API 6D / IOGP S-562	API 6D / IOGP S-562	API 6D / IOGP S-562
6. Size Range (NPS)	2" - 16"	2" - 16"	2" - 16"	2" - 16"
7. End Connection	ASME B16.5, RTJ	ASME B16.5, RTJ	ASME B16.5, RTJ	ASME B16.5, RTJ
8. Pressure Class	1500	1500	1500	1500
9. Temperature	-46°C to 150°C	-46°C to 150°C	-30°C to 150°C	-30°C to 150°C
10. Material Class	Stainless Steel	Stainless Steel	Stainless Steel	Stainless Steel
11. Body Material	ASTM A182 Gr F316	ASTM A182 Gr F316	ASTM A182 Gr F316	ASTM A182 Gr F316
12. Obturator Material	AISI 316	AISI 316	AISI 316 + Tungsten carbide coating	AISI 316 + Tungsten carbide coating
13. Seat Material	AISI 316	AISI 316	AISI 316 + Tungsten carbide coating	AISI 316 + Tungsten carbide coating
14. Seat Insert	PEEK	PEEK	N/A	N/A
15. Spring (Seat) Material	UNS N07750	UNS N07750	UNS N07750	UNS N07750
16. Stem Material	ASTM A276 (UNS S31803)	ASTM A276 (UNS S31803)	ASTM A276 (UNS S31803)	ASTM A276 (UNS S31803)
17. Seat-Stem Seal	Group E (acc. item A.7.1.5.6)	Group E (acc. item A.7.1.5.6)	Group B (acc. item A.7.1.5.6)	Group B (acc. item A.7.1.5.6)
18. Operator Type	Gearbox	Gearbox	Gearbox	Gearbox
19. Additional Requirement	N/A	Fire Tested (acc. item A.6.1.4)	N/A	Fire Tested (acc. item A.6.1.4)
20. Seat Type	Side A: SPE / Side B: DPE; DIB-2 & DBB	Side A: SPE / Side B: DPE; DIB-2 & DBB	Side A: SPE / Side B: DPE; DIB-2 & DBB	Side A: SPE / Side B: DPE; DIB-2 & DBB
21. Bore Type	Full Bore	Full Bore	Full Bore	Full Bore
22. Body Construction	split body, bolted	split body, bolted	split body, bolted	split body, bolted
23. Cladding or Coating	N/A	N/A	N/A	N/A
24. Valve Testing	FAT according A.9.3	FAT according A.9.3	FAT according A.9.3	FAT according A.9.3
25. Notes	N/A	N/A	Acceptance criteria for sealing tests see Annex A	Acceptance criteria for sealing tests see Annex A

Valve Code	VES-1500-3-S262	VES-1500-3-S263	VES-1500-3-S272	VES-1500-3-S273
Specs	G3	G3	G3	G3
1. Valve Type	Ball	Ball	Ball	Ball
2. Sealing Type	Metal to Metal	Metal to Metal	Metal to Metal	Metal to Metal
3. Valve Specification Level (VSL)	VSL-3	VSL-3	VSL-3	VSL-3
4. Ball Mouting	Trunnion	Trunnion	Trunnion	Trunnion
5. Standard	API 6D	API 6D	API 6D	API 6D
6. Size Range (NPS)	2" - 16"	2" - 16"	2" - 16"	2" - 16"
7. End Connection	ASME B16.5, RTJ	ASME B16.5, RTJ	ASME B16.5, RTJ	ASME B16.5, RTJ
8. Pressure Class	1500	1500	1500	1500
9. Temperature	0°C to 210°C	0°C to 210°C	-100°C to 200°C	-100°C to 200°C
10. Material Class	Stainless Steel	Stainless Steel	Stainless Steel	Stainless Steel
11. Body Material	ASTM A182 Gr F316	ASTM A182 Gr F316	ASTM A182 Gr F316	ASTM A182 Gr F316
12. Obturator Material	AISI 316 + Tungsten carbide coating	AISI 316 + Tungsten carbide coating	AISI 316 + Tungsten carbide coating	AISI 316 + Tungsten carbide coating
13. Seat Material	AISI 316 + Tungsten carbide coating	AISI 316 + Tungsten carbide coating	AISI 316 + Tungsten carbide coating	AISI 316 + Tungsten carbide coating
14. Seat Insert	N/A	N/A	N/A	N/A
15. Spring (Seat) Material	UNS N07750	UNS N07750	UNS N07750	UNS N07750
16. Stem Material	ASTM A276 (UNS S31803)	ASTM A276 (UNS S31803)	ASTM B637 (UNS N07718)	ASTM B637 (UNS N07718)
17. Seat-Stem Seal	Group C (acc. item A.7.1.5.6)	Group C (acc. item A.7.1.5.6)	Group E (acc. item A.7.1.5.6)	Group E (acc. item A.7.1.5.6)
18. Operator Type	Gearbox	Gearbox	Gearbox	Gearbox
19. Additional Requirement	N/A	Fire Tested (acc. item A.6.1.4)	N/A	Fire Tested (acc. item A.6.1.4)
20. Seat Type	Side A: SPE / Side B: DPE; DIB-2 & DBB	Side A: SPE / Side B: DPE; DIB-2 & DBB	Side A: SPE / Side B: DPE; DIB-2 & DBB	Side A: SPE / Side B: DPE; DIB-2 & DBB
21. Bore Type	Full Bore	Full Bore	Full Bore	Full Bore
22. Body Construction	split body, bolted	split body, bolted	split body, bolted	split body, bolted
23. Cladding or Coating	N/A	N/A	N/A	N/A
24. Valve Testing	FAT according A.9.3	FAT according A.9.3	FAT according A.9.3	FAT according A.9.3
25. Notes	Acceptance criteria for sealing tests see Annex A	Acceptance criteria for sealing tests see Annex A	Acceptance criteria for sealing tests see Annex A	Acceptance criteria for sealing tests see Annex A

Valve Code	VES-1500-4-C154	VES-1500-4-C164	VES-1500-4-C174	VES-1500-4-S254
Specs	G10P	G10P	G10P	G3
1. Valve Type	Ball	Ball	Ball	Ball
2. Sealing Type	Metal to Metal	Metal to Metal	Metal to Metal	Metal to Metal
3. Valve Specification Level (VSL)	VSL-4	VSL-4	VSL-4	VSL-4
4. Ball Mouting	Trunnion	Trunnion	Trunnion	Trunnion
5. Standard	API 6D / IOGP S-562	API 6D	API 6D	API 6D / IOGP S-562
6. Size Range (NPS)	6" - 24"	6" - 24"	6" - 24"	6" - 16"
7. End Connection	ASME B16.5, RTJ	ASME B16.5, RTJ	ASME B16.5, RTJ	ASME B16.5, RTJ
8. Pressure Class	1500	1500	1500	1500
9. Temperature	-29°C to 150°C	0°C to 210°C	-29°C to 200°C	-30°C to 150°C
10. Material Class	Carbon Steel	Carbon Steel	Carbon Steel	Stainless Steel
11. Body Material	ASTM A105 + SS316 weld overlay (acc. item A.7.1.7.3)	ASTM A105 + SS316 weld overlay (acc. item A.7.1.7.3)	ASTM A105 + SS316 weld overlay (acc. item A.7.1.7.3)	ASTM A182 Gr F316
12. Obturator Material	AISI 410 + Tungsten carbide coating	AISI 410 + Tungsten carbide coating	AISI 410 + Tungsten carbide coating	AISI 316 + Tungsten carbide coating
13. Seat Material	AISI 410 + Tungsten carbide coating	AISI 410 + Tungsten carbide coating	AISI 410 + Tungsten carbide coating	AISI 316 + Tungsten carbide coating
14. Seat Insert	N/A	N/A	N/A	N/A
15. Spring (Seat) Material	UNS N07750	UNS N07750	UNS N07750	UNS N07750
16. Stem Material	ASTM A276 (UNS S41000)	ASTM A276 (UNS S41000)	ASTM A276 (UNS S41000)	ASTM A276 (UNS S31803)
17. Seat-Stem Seal	Group B (acc. item A.7.1.5.6)	Group C (acc. item A.7.1.5.6)	Group E (acc. item A.7.1.5.6)	Group B (acc. item A.7.1.5.6)
18. Operator Type	Actuated	Actuated	Actuated	Actuated
19. Additional Requirement	Fire Tested (acc. item A.6.1.4)	Fire Tested (acc. item A.6.1.4)	Fire Tested (acc. item A.6.1.4)	Fire Tested (acc. item A.6.1.4)
20. Seat Type	Side A: SPE / Side B: DPE; DIB-2 & DBB (notes)	Side A: SPE / Side B: DPE; DIB-2 & DBB (notes)	Side A: SPE / Side B: DPE; DIB-2 & DBB (notes)	Side A: SPE / Side B: DPE; DIB-2 & DBB (notes)
21. Bore Type	Full Bore	Full Bore	Full Bore	Full Bore
22. Body Construction	split body, bolted	split body, bolted	split body, bolted	split body, bolted
23. Cladding or Coating	Partial clad - SS316 weld overlay on all body sealing areas	Partial clad - SS316 weld overlay on all body sealing areas	Partial clad - SS316 weld overlay on all body sealing areas	N/A
24. Valve Testing	FAT according A.9.3	FAT according A.9.3	FAT according A.9.3	FAT according A.9.3
25. Notes	Acceptance criteria for sealing tests see Annex A, DBB tests to be performed at both conditions, fully opened and closed, Vent and drain connections according Annex A	Acceptance criteria for sealing tests see Annex A, DBB tests to be performed at both conditions, fully opened and closed, Vent and drain connections according Annex A	Acceptance criteria for sealing tests see Annex A, DBB tests to be performed at both conditions, fully opened and closed, Vent and drain connections according Annex A	Acceptance criteria for sealing tests see Annex A, DBB tests to be performed at both conditions, fully opened and closed, Vent and drain connections according Annex A

Valve Code	VES-1500-4-S264	VES-1500-4-S274	VES-150-1-C110		VES-150-1-C120	
Specs	G3	G3	B9 B10 R9B S9B		B9 B10	
1. Valve Type	Ball	Ball	Ball		Ball	
2. Sealing Type	Metal to Metal	Metal to Metal	Soft		Soft	
3. Valve Specification Level (VSL)	VSL-4	VSL-4	VSL-1		VSL-1	
4. Ball Mouting	Trunnion	Trunnion	N/A		N/A	
5. Standard	API 6D	API 6D	API 6D / IOGP S-562		API 6D / IOGP S-562	
6. Size Range (NPS)	6" - 16"	6" - 16"	2" - 38"		2" - 36"	
7. End Connection	ASME B16.5, RTJ	ASME B16.5, RTJ	2" - 24"	ASME B16.5	2" - 24"	ASME B16.5
	N/A	N/A	26" - 38"	ASME B16.47 Series A	26" - 36"	ASME B16.47 Series A
8. Pressure Class	1500	1500	150		150	
9. Temperature	0°C to 210°C	-100°C to 200°C	-29°C to 150°C		0°C to 150°C	
10. Material Class	Stainless Steel	Stainless Steel	Carbon Steel		Carbon Steel	
11. Body Material	ASTM A182 Gr F316	ASTM A182 Gr F316	ASTM A105 or ASTM A216 Gr WCB + SS316 weld overlay (acc. item A.7.1.7.3)		ASTM A105 or ASTM A216 Gr WCB + SS316 weld overlay (acc. item A.7.1.7.3)	
12. Obturator Material	AISI 316 + Tungsten carbide coating	AISI 316 + Tungsten carbide coating	AISI 410		AISI 410	
13. Seat Material	AISI 316 + Tungsten carbide coating	AISI 316 + Tungsten carbide coating	AISI 410		AISI 410	
14. Seat Insert	N/A	N/A	PTFE reinforced with 25% Carbon		PTFE reinforced with 25% Carbon	
15. Spring (Seat) Material	UNS N07750	UNS N07750	UNS N07750		UNS N07750	
16. Stem Material	ASTM A276 (UNS S31803)	ASTM B637 (UNS N07718)	ASTM A276 (UNS S41000)		ASTM A276 (UNS S41000)	
17. Seat-Stem Seal	Group C (acc. item A.7.1.5.6)	Group E (acc. item A.7.1.5.6)	Group B (acc. item A.7.1.5.6)		Group C (acc. item A.7.1.5.6)	
18. Operator Type	Actuated	Actuated	N/A		N/A	
19. Additional Requirement	Fire Tested (acc. item A.6.1.4)	Fire Tested (acc. item A.6.1.4)	N/A		N/A	
20. Seat Type	Side A: SPE / Side B: DPE; DIB-2 & DBB (notes)	Side A: SPE / Side B: DPE; DIB-2 & DBB (notes)	Side A: SPE / Side B: SPE		Side A: SPE / Side B: SPE	
21. Bore Type	Full Bore	Full Bore	Full Bore		Full Bore	
22. Body Construction	split body, bolted	split body, bolted	split body, bolted		split body, bolted	
23. Cladding or Coating	N/A	N/A	Partial clad - SS316 weld overlay on all body sealing areas		Partial clad - SS316 weld overlay on all body sealing areas	
24. Valve Testing	FAT according A.9.3	FAT according A.9.3	FAT according A.9.3		FAT according A.9.3	
25. Notes	Acceptance criteria for sealing tests see Annex A, DBB tests to be performed at both conditions, fully opened and closed, Vent and drain connections according Annex A	Acceptance criteria for sealing tests see Annex A, DBB tests to be performed at both conditions, fully opened and closed, Vent and drain connections according Annex A	N/A		N/A	

Valve Code	VES-150-1-C130		VES-150-1-C150		VES-150-1-C160		VES-150-1-C170	
Specs	B9 B10		B9 B10		B4 B9 B10 S9B		B9 B10	
1. Valve Type	Ball		Ball		Ball		Ball	
2. Sealing Type	Soft		Metal to Metal		Metal to Metal		Metal to Metal	
3. Valve Specification Level (VSL)	VSL-1		VSL-1		VSL-1		VSL-1	
4. Ball Mouting	2" - 4"	Floating	2" - 4"	Floating	2" - 4"	Floating	2" - 4"	Floating
	6" - 36"	Trunnion	6" - 36"	Trunnion	6" - 36"	Trunnion	6" - 36"	Trunnion
5. Standard	API 6D / IOGP S-562		API 6D / IOGP S-562		API 6D		API 6D	
6. Size Range (NPS)	2" - 36"		2" - 36"		2" - 36"		2" - 36"	
7. End Connection	2" - 24"	ASME B16.5, RF	2" - 24"	ASME B16.5, RF	2" - 24"	ASME B16.5, RF	2" - 24"	ASME B16.5, RF
	26" - 36"	ASME B16.47 Series A, RF	26" - 36"	ASME B16.47 Series A, RF	26" - 36"	ASME B16.47 Series A, RF	26" - 36"	ASME B16.47 Series A, RF
8. Pressure Class	150		150		150		150	
9. Temperature	0°C to 150°C		0°C to 150°C		0°C to 210°C		0°C to 210°C	
10. Material Class	Carbon Steel		Carbon Steel		Carbon Steel		Carbon Steel	
11. Body Material	ASTM A105 or ASTM A216 Gr WCB + SS316 weld overlay (acc. item A.7.1.7.3)		ASTM A105 or ASTM A216 Gr WCB + SS316 weld overlay (acc. item A.7.1.7.3)		ASTM A105 or ASTM A216 Gr WCB + SS316 weld overlay (acc. item A.7.1.7.3)		ASTM A105 or ASTM A216 Gr WCB + SS316 weld overlay (acc. item A.7.1.7.3)	
12. Obturator Material	AISI 410		AISI 410 + Tungsten carbide coating		AISI 410 + Tungsten carbide coating		AISI 410 + Tungsten carbide coating	
13. Seat Material	AISI 410		AISI 410 + Tungsten carbide coating		AISI 410 + Tungsten carbide coating		AISI 410 + Tungsten carbide coating	
14. Seat Insert	PTFE reinforced with 25% Carbon		N/A		N/A		N/A	
15. Spring (Seat) Material	UNS N07750		UNS N07750		UNS N07750		UNS N07750	
16. Stem Material	ASTM A276 (UNS S41000)		ASTM A276 (UNS S41000)		ASTM A276 (UNS S41000)		ASTM A276 (UNS S41000)	
17. Seat-Stem Seal	Group D (acc. item A.7.1.5.6)		Group A (acc. item A.7.1.5.6)		Group C (acc. item A.7.1.5.6)		Group D (acc. item A.7.1.5.6)	
18. Operator Type	2" - 4"	Lever	2" - 4"	Lever	2" - 4"	Lever	2" - 4"	Lever
	6" - 36"	Gearbox	6" - 36"	Gearbox	6" - 36"	Gearbox	6" - 36"	Gearbox
19. Additional Requirement	N/A		N/A		N/A		N/A	
20. Seat Type	Side A: SPE / Side B: SPE		Side A: SPE / Side B: SPE		Side A: SPE / Side B: SPE		Side A: SPE / Side B: SPE	
21. Bore Type	Full Bore		Full Bore		Full Bore		Full Bore	
22. Body Construction	split body, bolted		split body, bolted		split body, bolted		split body, bolted	
23. Cladding or Coating	Partial clad - SS316 weld overlay on all body sealing areas		Partial clad - SS316 weld overlay on all body sealing areas		Partial clad - SS316 weld overlay on all body sealing areas		Partial clad - SS316 weld overlay on all body sealing areas	
24. Valve Testing	FAT according A.9.3		FAT according A.9.3		FAT according A.9.3		FAT according A.9.3	
25. Notes	N/A		N/A		N/A		N/A	

Valve Code	VES-150-1-C180		VES-150-1-C210		VES-150-1-C230		VES-150-1-C250	
Specs	B9 B10		B6 B19		B6 B19		B6 B19	
1. Valve Type	Ball		Ball		Ball		Ball	
2. Sealing Type	Metal to Metal		Soft		Soft		Metal to Metal	
3. Valve Specification Level (VSL)	VSL-1		VSL-1		VSL-1		VSL-1	
4. Ball Mouting	2" - 4"	Floating	2" - 4"	Floating	2" - 4"	Floating	2" - 4"	Floating
	6" - 36"	Trunnion	6" - 36"	Trunnion	6" - 36"	Trunnion	6" - 36"	Trunnion
5. Standard	API 6D		API 6D / IOGP S-562		API 6D / IOGP S-562		API 6D / IOGP S-562	
6. Size Range (NPS)	2" - 36"		2" - 36"		2" - 36"		2" - 36"	
7. End Connection	2" - 24"	ASME B16.5, RF	2" - 24"	ASME B16.5, RF	2" - 24"	ASME B16.5, RF	2" - 24"	ASME B16.5, RF
	26" - 36"	ASME B16.47 Series A, RF	26" - 36"	ASME B16.47 Series A, RF	26" - 36"	ASME B16.47 Series A, RF	26" - 36"	ASME B16.47 Series A, RF
8. Pressure Class	150		150		150		150	
9. Temperature	0°C to 400°C		-30°C to 150°C		-46°C to 150°C		-30°C to 150°C	
10. Material Class	Carbon Steel		Carbon Steel		Carbon Steel		Carbon Steel	
11. Body Material	ASTM A105 or ASTM A216 Gr WCB + SS316 weld overlay (acc. item A.7.1.7.3)		ASTM A350 Gr LF2 CL1 or ASTM A352 Gr LCB + Inconel 625 weld overlay (acc. item A.7.1.7.3)		ASTM A350 Gr LF2 CL1 or ASTM A352 Gr LCB + Inconel 625 weld overlay (acc. item A.7.1.7.3)		ASTM A350 Gr LF2 CL1 or ASTM A352 Gr LCB + Inconel 625 weld overlay (acc. item A.7.1.7.3)	
12. Obturator Material	AISI 410 + Chrome-Nickel Spray and Fuse (acc. Item A.8.2.2.4)		AISI 316		AISI 316		AISI 316 + Tungsten carbide coating	
13. Seat Material	AISI 410 + Chrome-Nickel Spray and Fuse (acc. Item A.8.2.2.4)		AISI 316		AISI 316		AISI 316 + Tungsten carbide coating	
14. Seat Insert	N/A		PTFE reinforced with 25% Carbon		PTFE reinforced with 25% Carbon		N/A	
15. Spring (Seat) Material	UNS N07750		UNS N07750		UNS N07750		UNS N07750	
16. Stem Material	ASTM A276 (UNS S41000)		ASTM A276 (UNS S31600)		ASTM A276 (UNS S31600)		ASTM A276 (UNS S31600)	
17. Seat-Stem Seal	Group F (acc. item A.7.1.5.6)		Group B (acc. item A.7.1.5.6)		Group E (acc. item A.7.1.5.6)		Group B (acc. item A.7.1.5.6)	
18. Operator Type	2" - 4"	Lever	2" - 4"	Lever	2" - 4"	Lever	2" - 4"	Lever
	6" - 36"	Gearbox	6" - 36"	Gearbox	6" - 36"	Gearbox	6" - 36"	Gearbox
19. Additional Requirement	N/A		N/A		N/A		N/A	
20. Seat Type	Side A: SPE / Side B: SPE		Side A: SPE / Side B: SPE		Side A: SPE / Side B: SPE		Side A: SPE / Side B: SPE	
21. Bore Type	Full Bore		Full Bore		Full Bore		Full Bore	
22. Body Construction	split body, bolted		split body, bolted		split body, bolted		split body, bolted	
23. Cladding or Coating	Partial clad - SS316 weld overlay on all body sealing areas		Partial clad - Inconel 625 weld overlay on all body sealing areas		Partial clad - Inconel 625 weld overlay on all body sealing areas		Partial clad - Inconel 625 weld overlay on all body sealing areas	
24. Valve Testing	FAT according A.9.3		FAT according A.9.3		FAT according A.9.3		FAT according A.9.3	
25. Notes	N/A		N/A		N/A		N/A	

Valve Code	VES-150-1-C270		VES-150-1-C280		VES-150-1-C520		VES-150-1-C530	
Specs	B6 B19		B6 B19		B30		B30	
1. Valve Type	Ball		Ball		Ball		Ball	
2. Sealing Type	Metal to Metal		Metal to Metal		Soft		Soft	
3. Valve Specification Level (VSL)	VSL-1		VSL-1		VSL-1		VSL-1	
4. Ball Mouting	2" - 4"	Floating	2" - 4"	Floating	2" - 4"	Floating	2" - 4"	Floating
	6" - 36"	Trunnion	6" - 36"	Trunnion	6" - 30"	Trunnion	6" - 30"	Trunnion
5. Standard	API 6D		API 6D		API 6D / IOGP S-562		API 6D / IOGP S-562	
6. Size Range (NPS)	2" - 36"		2" - 36"		2" - 30"		2" - 30"	
7. End Connection	2" - 24"	ASME B16.5, RF	2" - 24"	ASME B16.5, RF	2" - 24"	ASME B16.5, RF	2" - 24"	ASME B16.5, RF
	26" - 36"	ASME B16.47 Series A, RF	26" - 36"	ASME B16.47 Series A, RF	26" - 30"	ASME B16.47 Series A, RF	26" - 30"	ASME B16.47 Series A, RF
8. Pressure Class	150		150		150		150	
9. Temperature	-100°C to 200°C		-100°C to 345°C		0°C to 150°C		0°C to 150°C	
10. Material Class	Carbon Steel		Carbon Steel		Carbon Steel		Carbon Steel	
11. Body Material	ASTM A350 Gr LF2 CL1 or ASTM A352 Gr LCB + Inconel 625 weld overlay (acc. item A.7.1.7.3)		ASTM A350 Gr LF2 CL1 or ASTM A352 Gr LCB + Inconel 625 weld overlay (acc. item A.7.1.7.3)		ASTM A105 or ASTM A216 Gr WCB + Inconel 625 weld overlay (acc. item A.7.1.7.3)		ASTM A105 or ASTM A216 Gr WCB + Inconel 625 weld overlay (acc. item A.7.1.7.3)	
12. Obturator Material	AISI 316 + Tungsten carbide coating		AISI 316 + Chrome-Nickel Spray and Fuse (acc. Item A.8.2.2.4)		ASTM A105 + Inconel 625 weld overlay (acc. item A.7.1.7.3)		ASTM A105 + Inconel 625 weld overlay (acc. item A.7.1.7.3)	
13. Seat Material	AISI 316 + Tungsten carbide coating		AISI 316 + Chrome-Nickel Spray and Fuse (acc. Item A.8.2.2.4)		ASTM A105 + Inconel 625 weld overlay (acc. item A.7.1.7.3)		ASTM A105 + Inconel 625 weld overlay (acc. item A.7.1.7.3)	
14. Seat Insert	N/A		N/A		PTFE reinforced with 25% Carbon		PTFE reinforced with 25% Carbon	
15. Spring (Seat) Material	UNS N07750		UNS N07750		UNS N07750		UNS N07750	
16. Stem Material	ASTM A276 (UNS S31600)		ASTM A276 (UNS S31600)		ASTM B637 (UNS N07718)		ASTM B637 (UNS N07718)	
17. Seat-Stem Seal	Group E (acc. item A.7.1.5.6)		Group F (acc. item A.7.1.5.6)		Group C (acc. item A.7.1.5.6)		Group D (acc. item A.7.1.5.6)	
18. Operator Type	2" - 4"	Lever	2" - 4"	Lever	2" - 4"	Lever	2" - 4"	Lever
	6" - 36"	Gearbox	6" - 36"	Gearbox	6" - 30"	Gearbox	6" - 30"	Gearbox
19. Additional Requirement	N/A		N/A		N/A		N/A	
20. Seat Type	Side A: SPE / Side B: SPE		Side A: SPE / Side B: SPE		Side A: SPE / Side B: SPE		Side A: SPE / Side B: SPE	
21. Bore Type	Full Bore		Full Bore		Full Bore		Full Bore	
22. Body Construction	split body, bolted		split body, bolted		split body, bolted		split body, bolted	
23. Cladding or Coating	Partial clad - Inconel 625 weld overlay on all body sealing areas		Partial clad - Inconel 625 weld overlay on all body sealing areas		Full clad - Inconel 625 weld overlay on all wetted parts		Full clad - Inconel 625 weld overlay on all wetted parts	
24. Valve Testing	FAT according A.9.3		FAT according A.9.3		FAT according A.9.3		FAT according A.9.3	
25. Notes	N/A		N/A		N/A		N/A	

Valve Code	VES-150-1-C560		VES-150-1-C570		VES-150-1-D200	VES-150-1-D210	
Specs	B30		B30		B11 B26	B11 B16	
1. Valve Type	Ball		Ball		Ball	Ball	
2. Sealing Type	Metal to Metal		Metal to Metal		Soft	Soft	
3. Valve Specification Level (VSL)	VSL-1		VSL-1		VSL-1	VSL-1	
4. Ball Mouting	2" - 4"	Floating	2" - 4"	Floating	N/A	2" - 4"	Floating
	6" - 30"	Trunnion	6" - 30"	Trunnion	N/A	6" - 32"	Trunnion
5. Standard	API 6D		API 6D		API 6D	API 6D / IOGP S-562	
6. Size Range (NPS)	2" - 30"		2" - 30"		1" - 1 1/2"	2" - 32"	
7. End Connection	2" - 24"	ASME B16.5, RF	2" - 24"	ASME B16.5, RF	N/A	2" - 24"	ASME B16.5, RF
	26" - 30"	ASME B16.47 Series A, RF	26" - 30"	ASME B16.47 Series A, RF	N/A	26" - 32"	ASME B16.47 Series A, RF
8. Pressure Class	150		150		150	150	
9. Temperature	0°C to 210°C		0°C to 210°C		0°C to 150°C	-30°C to 150°C	
10. Material Class	Carbon Steel		Carbon Steel		Duplex Steel	Duplex Steel	
11. Body Material	ASTM A105 or ASTM A216 Gr WCB + Inconel 625 weld overlay (acc. item A.7.1.7.3)		ASTM A105 or ASTM A216 Gr WCB + Inconel 625 weld overlay (acc. item A.7.1.7.3)		ASTM A182 Gr F51	ASTM A182 Gr F51 or ASTM A995 Gr 4a	
12. Obturator Material	ASTM A105 + Inconel 625 weld overlay (acc. item A.7.1.7.3) + Tungsten carbide coating		ASTM A105 + Inconel 625 weld overlay (acc. item A.7.1.7.3) + Tungsten carbide coating		Duplex (UNS S31803)	Duplex (UNS S31803)	
13. Seat Material	ASTM A105 + Inconel 625 weld overlay (acc. item A.7.1.7.3) + Tungsten carbide coating		ASTM A105 + Inconel 625 weld overlay (acc. item A.7.1.7.3) + Tungsten carbide coating		PTFE reinforced with 25% Carbon	Duplex (UNS S31803)	
14. Seat Insert	N/A		N/A		N/A	PTFE reinforced with 25% Carbon	
15. Spring (Seat) Material	UNS N07750		UNS N07750		N/A	UNS N07750	
16. Stem Material	ASTM B637 (UNS N07718)		ASTM B637 (UNS N07718)		ASTM A276 (UNS S31803)	ASTM A276 (UNS S31803)	
17. Seat-Stem Seal	Group C (acc. item A.7.1.5.6)		Group D (acc. item A.7.1.5.6)		Group A (acc. item A.7.1.5.6)	Group B (acc. item A.7.1.5.6)	
18. Operator Type	2" - 4"	Lever	2" - 4"	Lever	N/A	2" - 4"	Lever
	6" - 30"	Gearbox	6" - 30"	Gearbox	N/A	6" - 32"	Gearbox
19. Additional Requirement	N/A		N/A		Fire Tested (acc. item A.6.1.4)	N/A	
20. Seat Type	Side A: SPE / Side B: SPE		Side A: SPE / Side B: SPE		N/A	Side A: SPE / Side B: SPE	
21. Bore Type	Full Bore		Full Bore		Full Bore	Full Bore	
22. Body Construction	split body, bolted		split body, bolted		split body, bolted	split body, bolted	
23. Cladding or Coating	Full clad - Inconel 625 weld overlay on all wetted parts		Full clad - Inconel 625 weld overlay on all wetted parts		N/A	N/A	
24. Valve Testing	FAT according A.9.3		FAT according A.9.3		FAT according A.9.3	FAT according A.9.3	
25. Notes	N/A		N/A		N/A	N/A	

Valve Code	VES-150-1-D220		VES-150-1-D230		VES-150-1-D310		VES-150-1-D330	
Specs	B16		B16		B12		B12	
1. Valve Type	Ball		Ball		Ball		Ball	
2. Sealing Type	Soft		Soft		Soft		Soft	
3. Valve Specification Level (VSL)	VSL-1		VSL-1		VSL-1		VSL-1	
4. Ball Mouting	2" - 4"	Floating	2" - 4"	Floating	2" - 4"	Floating	2" - 4"	Floating
	6" - 32"	Trunnion	6" - 32"	Trunnion	6" - 36"	Trunnion	6" - 36"	Trunnion
5. Standard	API 6D / IOGP S-562		API 6D / IOGP S-562		API 6D / IOGP S-562		API 6D / IOGP S-562	
6. Size Range (NPS)	2" - 32"		2" - 32"		2" - 36"		2" - 36"	
7. End Connection	2" - 24"	ASME B16.5, RF	2" - 24"	ASME B16.5, RF	2" - 24"	ASME B16.5, RF	2" - 24"	ASME B16.5, RF
	26" - 32"	ASME B16.47 Series A, RF	26" - 32"	ASME B16.47 Series A, RF	26" - 36"	ASME B16.47 Series A, RF	26" - 36"	ASME B16.47 Series A, RF
8. Pressure Class	150		150		150		150	
9. Temperature	0°C to 150°C		-46°C to 150°C		-30°C to 150°C		0°C to 150°C	
10. Material Class	Duplex Steel		Duplex Steel		Duplex Steel		Duplex Steel	
11. Body Material	ASTM A182 Gr F51 or ASTM A995 Gr 4a		ASTM A182 Gr F51 or ASTM A995 Gr 4a		ASTM A182 Gr F55 or ASTM A995 Gr 6a		ASTM A182 Gr F55 or ASTM A995 Gr 6a	
12. Obturator Material	Duplex (UNS S31803)		Duplex (UNS S31803)		Super Duplex (UNS S32760)		Super Duplex (UNS S32760)	
13. Seat Material	Duplex (UNS S31803)		Duplex (UNS S31803)		Super Duplex (UNS S32760)		Super Duplex (UNS S32760)	
14. Seat Insert	PTFE reinforced with 25% Carbon		PTFE reinforced with 25% Carbon		PTFE reinforced with 25% Carbon		PTFE reinforced with 25% Carbon	
15. Spring (Seat) Material	UNS N07750		UNS N07750		UNS N07750		UNS N07750	
16. Stem Material	ASTM A276 (UNS S31803)		ASTM A276 (UNS S31803)		ASTM A276 (UNS S32760)		ASTM A276 (UNS S32760)	
17. Seat-Stem Seal	Group C (acc. item A.7.1.5.6)		Group E (acc. item A.7.1.5.6)		Group B (acc. item A.7.1.5.6)		Group D (acc. item A.7.1.5.6)	
18. Operator Type	2" - 4"	Lever	2" - 4"	Lever	2" - 4"	Lever	2" - 4"	Lever
	6" - 32"	Gearbox	6" - 32"	Gearbox	6" - 36"	Gearbox	6" - 36"	Gearbox
19. Additional Requirement	N/A		N/A		N/A		N/A	
20. Seat Type	Side A: SPE / Side B: SPE		Side A: SPE / Side B: SPE		Side A: SPE / Side B: SPE		Side A: SPE / Side B: SPE	
21. Bore Type	Full Bore		Full Bore		Full Bore		Full Bore	
22. Body Construction	split body, bolted		split body, bolted		split body, bolted		split body, bolted	
23. Cladding or Coating	N/A		N/A		N/A		N/A	
24. Valve Testing	FAT according A.9.3		FAT according A.9.3		FAT according A.9.3		FAT according A.9.3	
25. Notes	N/A		N/A		N/A		N/A	

Valve Code	VES-150-1-S210		VES-150-1-S220		VES-150-1-S230		VES-150-1-S250	
Specs	B3 R3B S3B		B3		B3		B3	
1. Valve Type	Ball		Ball		Ball		Ball	
2. Sealing Type	Soft		Soft		Soft		Metal to Metal	
3. Valve Specification Level (VSL)	VSL-1		VSL-1		VSL-1		VSL-1	
4. Ball Mouting	2" - 4"	Floating	2" - 4"	Floating	2" - 4"	Floating	2" - 4"	Floating
	6" - 36"	Trunnion	6" - 36"	Trunnion	6" - 36"	Trunnion	6" - 36"	Trunnion
5. Standard	API 6D / IOGP S-562		API 6D / IOGP S-562		API 6D / IOGP S-562		API 6D / IOGP S-562	
6. Size Range (NPS)	2" - 36"		2" - 36"		2" - 36"		2" - 36"	
7. End Connection	2" - 24"	ASME B16.5, RF	2" - 24"	ASME B16.5, RF	2" - 24"	ASME B16.5, RF	2" - 24"	ASME B16.5, RF
	26" - 36"	ASME B16.47 Series A, RF	26" - 36"	ASME B16.47 Series A, RF	26" - 36"	ASME B16.47 Series A, RF	26" - 36"	ASME B16.47 Series A, RF
8. Pressure Class	150		150		150		150	
9. Temperature	-30°C to 150°C		0°C to 150°C		-46°C to 150°C		-30°C to 150°C	
10. Material Class	Stainless Steel		Stainless Steel		Stainless Steel		Stainless Steel	
11. Body Material	ASTM A182 Gr F316 or ASTM A351 Gr CF8M		ASTM A182 Gr F316 or ASTM A351 Gr CF8M		ASTM A182 Gr F316 or ASTM A351 Gr CF8M		ASTM A182 Gr F316 or ASTM A351 Gr CF8M	
12. Obturator Material	AISI 316		AISI 316		AISI 316		AISI 316 + Tungsten carbide coating	
13. Seat Material	AISI 316		AISI 316		AISI 316		AISI 316 + Tungsten carbide coating	
14. Seat Insert	PTFE reinforced with 25% Carbon		PTFE reinforced with 25% Carbon		PTFE reinforced with 25% Carbon		N/A	
15. Spring (Seat) Material	UNS N07750		UNS N07750		UNS N07750		UNS N07750	
16. Stem Material	ASTM A276 (UNS S31600)		ASTM A276 (UNS S31600)		ASTM A276 (UNS S31600)		ASTM A276 (UNS S31600)	
17. Seat-Stem Seal	Group B (acc. item A.7.1.5.6)		Group C (acc. item A.7.1.5.6)		Group E (acc. item A.7.1.5.6)		Group B (acc. item A.7.1.5.6)	
18. Operator Type	2" - 4"	Lever	2" - 4"	Lever	2" - 4"	Lever	2" - 4"	Lever
	6" - 36"	Gearbox	6" - 36"	Gearbox	6" - 36"	Gearbox	6" - 36"	Gearbox
19. Additional Requirement	N/A		N/A		N/A		N/A	
20. Seat Type	Side A: SPE / Side B: SPE		Side A: SPE / Side B: SPE		Side A: SPE / Side B: SPE		Side A: SPE / Side B: SPE	
21. Bore Type	Full Bore		Full Bore		Full Bore		Full Bore	
22. Body Construction	split body, bolted		split body, bolted		split body, bolted		split body, bolted	
23. Cladding or Coating	N/A		N/A		N/A		N/A	
24. Valve Testing	FAT according A.9.3		FAT according A.9.3		FAT according A.9.3		FAT according A.9.3	
25. Notes	N/A		N/A		N/A		N/A	

Valve Code	VES-150-1-S260		VES-150-1-S270		VES-150-1-S280		VES-150-1-U300
Specs	B3		B3		B3		B7R B7 B14 B23
1. Valve Type	Ball		Ball		Ball		Ball
2. Sealing Type	Metal to Metal		Metal to Metal		Metal to Metal		Soft
3. Valve Specification Level (VSL)	VSL-1		VSL-1		VSL-1		VSL-1
4. Ball Mouting	2" - 4"	Floating	2" - 4"	Floating	2" - 4"	Floating	N/A
	6" - 36"	Trunnion	6" - 36"	Trunnion	6" - 36"	Trunnion	N/A
5. Standard	API 6D / IOGP S-562		API 6D / IOGP S-562		API 6D / IOGP S-562		API 6D
6. Size Range (NPS)	2" - 36"		2" - 36"		2" - 36"		1" - 1 ½"
7. End Connection	2" - 24"	ASME B16.5, RF	2" - 24"	ASME B16.5, RF	2" - 24"	ASME B16.5, RF	ASME B16.5, RF
	26" - 36"	ASME B16.47 Series A, RF	26" - 36"	ASME B16.47 Series A, RF	26" - 36"	ASME B16.47 Series A, RF	N/A
8. Pressure Class	150		150		150		150
9. Temperature	0°C to 210°C		-100°C to 200°C		-100°C to 400°C		0°C to 75°C
10. Material Class	Stainless Steel		Stainless Steel		Stainless Steel		Uncommon Materials
11. Body Material	ASTM A182 Gr F316 or ASTM A351 Gr CF8M		ASTM A182 Gr F316 or ASTM A351 Gr CF8M		ASTM A182 Gr F316 or ASTM A351 Gr CF8M		ASTM B148 (UNS C95800)
12. Obturator Material	AISI 316 + Tungsten carbide coating		AISI 316 + Tungsten carbide coating		AISI 316 + Chrome-Nickel Spray and Fuse (acc. Item A.8.2.2.4)		ASTM B148 (UNS C95800)
13. Seat Material	AISI 316 + Tungsten carbide coating		AISI 316 + Tungsten carbide coating		AISI 316 + Chrome-Nickel Spray and Fuse (acc. Item A.8.2.2.4)		PTFE reinforced with 25% Carbon
14. Seat Insert	N/A		N/A		N/A		N/A
15. Spring (Seat) Material	UNS N07750		UNS N07750		UNS N07750		N/A
16. Stem Material	ASTM A276 (UNS S31600)		ASTM A276 (UNS S31600)		ASTM A276 (UNS S31600)		Monel K500
17. Seat-Stem Seal	Group C (acc. item A.7.1.5.6)		Group E (acc. item A.7.1.5.6)		Group F (acc. item A.7.1.5.6)		Group A (acc. item A.7.1.5.6)
18. Operator Type	2" - 4"	Lever	2" - 4"	Lever	2" - 4"	Lever	N/A
	6" - 36"	Gearbox	6" - 36"	Gearbox	6" - 36"	Gearbox	N/A
19. Additional Requirement	N/A		N/A		N/A		N/A
20. Seat Type	Side A: SPE / Side B: SPE		Side A: SPE / Side B: SPE		Side A: SPE / Side B: SPE		N/A
21. Bore Type	Full Bore		Full Bore		Full Bore		Full Bore
22. Body Construction	split body, bolted		split body, bolted		split body, bolted		split body, bolted
23. Cladding or Coating	N/A		N/A		N/A		N/A
24. Valve Testing	FAT according A.9.3		FAT according A.9.3		FAT according A.9.3		FAT according A.9.3
25. Notes	N/A		N/A		N/A		N/A

Valve Code	VES-150-1-U310	VES-150-1-U600	VES-1502-1-S206	VES-1502-1-S207
Specs	B7R B7 B14 B23	B14 B27	F3 G3	F3 G3
1. Valve Type	Ball	Ball	Ball	Ball
2. Sealing Type	Soft	Soft	Soft	Metal to Metal
3. Valve Specification Level (VSL)	VSL-1	VSL-1	VSL-1	VSL-1
4. Ball Mouting	Floating	Floating	N/A	N/A
5. Standard	API 6D / IOGP S-562	Manufacturer standard	ASME B16.34 LTD	ASME B16.34 LTD
6. Size Range (NPS)	2" - 4"	1" - 6"	½" - 1 ½"	½" - 1 ½"
7. End Connection	ASME B16.5, RF	ASME B16.42, FF	N/A	N/A
8. Pressure Class	150	150	1500	1500
9. Temperature	0°C to 75°C	0°C to 70°C	-30°C to 150°C	-46°C to 200°C
10. Material Class	Uncommon Materials	Uncommon Materials	Stainless Steel	Stainless Steel
11. Body Material	ASTM B148 (UNS C95800)	ASTM A395 60-40-18 + PFA liner	ASTM A182 Gr F316/316L	ASTM A182 Gr F316/316L
12. Obturator Material	ASTM B148 (UNS C95800)	Stainless Steel + PFA liner	AISI 316	AISI 316 + Hard Coating (acc. Item A.7.1.7.4)
13. Seat Material	ASTM B148 (UNS C95800)	PTFE	AISI 316	AISI 316 + Hard Coating (acc. Item A.7.1.7.4)
14. Seat Insert	PTFE reinforced with 25% Carbon	N/A	PEEK	N/A
15. Spring (Seat) Material	UNS N07750	N/A	UNS N07750	UNS N07750
16. Stem Material	Monel K500	According manufacturer standard, fitted to service conditions	ASTM B637 (UNS N07718)	ASTM B637 (UNS N07718)
17. Seat-Stem Seal	Group A (acc. item A.7.1.5.6)	According to manufacturer standard, fitted to service conditions	Group B (acc. item A.7.1.5.6)	Group E (acc. item A.7.1.5.6)
18. Operator Type	Lever	Lever	N/A	N/A
19. Additional Requirement	N/A	N/A	Fire Tested (acc. item A.6.1.4)	Fire Tested (acc. item A.6.1.4)
20. Seat Type	Side A: SPE / Side B: SPE	N/A	Side A: SPE / Side B: SPE	Side A: SPE / Side B: SPE
21. Bore Type	Full Bore	Full Bore	Full Bore	Full Bore
22. Body Construction	split body, bolted	split body, bolted	split body, bolted	split body, bolted
23. Cladding or Coating	N/A	N/A	N/A	N/A
24. Valve Testing	FAT according A.9.3	FAT according manufacturer standard	FAT according A.9.3	FAT according A.9.3
25. Notes	N/A	N/A	N/A	N/A

Valve Code	VES-1502-2-S206	VES-1502-2-S207	VES-1502-3-S207	VES-150-2-C110
Specs	F3 G3	F3 G3	F3 G3	B9 B10 S9B
1. Valve Type	Ball	Ball	Ball	Ball
2. Sealing Type	Soft	Metal to Metal	Metal to Metal	Soft
3. Valve Specification Level (VSL)	VSL-2	VSL-2	VSL-3	VSL-2
4. Ball Mouting	Trunnion	Trunnion	Trunnion	N/A
5. Standard	ASME B16.34 LTD	ASME B16.34 LTD	ASME B16.34 LTD	API 6D / IOGP S-562
6. Size Range (NPS)	½" - 1 ½"	½" - 1 ½"	½" - 1 ½"	2" - 36"
7. End Connection	socket weld ends ASME B16.11 with nipple SCH 80/80S	socket weld ends ASME B16.11 with nipple SCH 80/80S	socket weld ends ASME B16.11 with nipple SCH 80/80S	N/A
8. Pressure Class	1500	1500	1500	150
9. Temperature	-30°C to 150°C	-100°C to 200°C	-46°C to 200°C	-29°C to 150°C
10. Material Class	Stainless Steel	Stainless Steel	Stainless Steel	Carbon Steel
11. Body Material	ASTM A182 Gr F316/316L	ASTM A182 Gr F316/316L	ASTM A182 Gr F316/316L	ASTM A105 or ASTM A216 Gr WCB
12. Obturator Material	AISI 316	AISI 316 + Hard Coating (acc. Item A.7.1.7.4)	AISI 316 + Hard Coating (acc. Item A.7.1.7.4)	AISI 410
13. Seat Material	AISI 316	AISI 316 + Hard Coating (acc. Item A.7.1.7.4)	AISI 316 + Hard Coating (acc. Item A.7.1.7.4)	AISI 410
14. Seat Insert	PEEK	N/A	N/A	PTFE reinforced with 25% Carbon
15. Spring (Seat) Material	UNS N07750	UNS N07750	UNS N07750	UNS N07750
16. Stem Material	ASTM B637 (UNS N07718)	ASTM B637 (UNS N07718)	ASTM B637 (UNS N07718)	ASTM A276 (UNS S41000)
17. Seat-Stem Seal	Group B (acc. item A.7.1.5.6)	Group E (acc. item A.7.1.5.6)	Group E (acc. item A.7.1.5.6)	Group B (acc. item A.7.1.5.6)
18. Operator Type	Lever	Lever	Lever	N/A
19. Additional Requirement	Fire Tested (acc. item A.6.1.4)	Fire Tested (acc. item A.6.1.4)	Fire Tested (acc. item A.6.1.4)	N/A
20. Seat Type	Side A: SPE / Side B: SPE	Side A: SPE / Side B: SPE	Side A: SPE / Side B: SPE	Side A: SPE / Side B: SPE
21. Bore Type	Full Bore	Full Bore	Full Bore	Full Bore
22. Body Construction	split body, bolted	split body, bolted	split body, bolted	split body, bolted
23. Cladding or Coating	N/A	N/A	N/A	Partial clad - SS316 weld overlay on all body sealing areas
24. Valve Testing	FAT according A.9.3	FAT according A.9.3	FAT according A.9.3	FAT according A.9.3
25. Notes	N/A	N/A	N/A	N/A

Valve Code	VES-150-2-C111		VES-150-2-C116		VES-150-2-C120		VES-150-2-C126	
Specs	B10		B9 B10		B9 B10		B9 B10	
1. Valve Type	Ball		Ball		Ball		Ball	
2. Sealing Type	Soft		Soft		Soft		Soft	
3. Valve Specification Level (VSL)	VSL-2		VSL-2		VSL-2		VSL-2	
4. Ball Mouting	2" - 4"	Floating	2" - 4"	Floating	2" - 4"	Floating	2" - 4"	Floating
	6" - 36"	Trunnion	6" - 36"	Trunnion	6" - 36"	Trunnion	6" - 36"	Trunnion
5. Standard	API 6D / IOGP S-562		API 6D / IOGP S-562		API 6D / IOGP S-562		API 6D / IOGP S-562	
6. Size Range (NPS)	2" - 36"		2" - 36"		2" - 36"		2" - 36"	
7. End Connection	2" - 24"	ASME B16.5, RF	2" - 24"	ASME B16.5, RF	2" - 24"	ASME B16.5, RF	2" - 24"	ASME B16.5, RF
	26" - 36"	ASME B16.47 Series A, RF	26" - 36"	ASME B16.47 Series A, RF	26" - 36"	ASME B16.47 Series A, RF	26" - 36"	ASME B16.47 Series A, RF
8. Pressure Class	150		150		150		150	
9. Temperature	0°C to 150°C		0°C to 150°C		0°C to 150°C		0°C to 150°C	
10. Material Class	Carbon Steel		Carbon Steel		Carbon Steel		Carbon Steel	
11. Body Material	ASTM A105 or ASTM A216 Gr WCB + SS316 weld overlay (acc. item A.7.1.7.3)		ASTM A105 or ASTM A216 Gr WCB + SS316 weld overlay (acc. item A.7.1.7.3)		ASTM A105 or ASTM A216 Gr WCB + SS316 weld overlay (acc. item A.7.1.7.3)		ASTM A105 or ASTM A216 Gr WCB + SS316 weld overlay (acc. item A.7.1.7.3)	
12. Obturator Material	AISI 410		AISI 410		AISI 410		AISI 410	
13. Seat Material	AISI 410		AISI 410		AISI 410		AISI 410	
14. Seat Insert	PTFE reinforced with 25% Carbon		PTFE reinforced with 25% Carbon		PTFE reinforced with 25% Carbon		PTFE reinforced with 25% Carbon	
15. Spring (Seat) Material	UNS N07750		UNS N07750		UNS N07750		UNS N07750	
16. Stem Material	ASTM A276 (UNS S41000)		ASTM A276 (UNS S41000)		ASTM A276 (UNS S41000)		ASTM A276 (UNS S41000)	
17. Seat-Stem Seal	Group A (acc. item A.7.1.5.6)		Group A (acc. item A.7.1.5.6)		Group C (acc. item A.7.1.5.6)		Group C (acc. item A.7.1.5.6)	
18. Operator Type	2" - 4"	Lever	2" - 4"	Lever	2" - 4"	Lever	2" - 4"	Lever
	6" - 36"	Gearbox	6" - 36"	Gearbox	6" - 36"	Gearbox	6" - 36"	Gearbox
19. Additional Requirement	Fire Tested (acc. item A.6.1.4)		N/A		N/A		N/A	
20. Seat Type	Side A: SPE / Side B: SPE		Side A: SPE / Side B: DPE; DIB-2 & DBB		Side A: SPE / Side B: SPE		Side A: SPE / Side B: DPE; DIB-2 & DBB	
21. Bore Type	Full Bore		Full Bore		Full Bore		Full Bore	
22. Body Construction	split body, bolted		split body, bolted		split body, bolted		split body, bolted	
23. Cladding or Coating	Partial clad - SS316 weld overlay on all body sealing areas		Partial clad - SS316 weld overlay on all body sealing areas		Partial clad - SS316 weld overlay on all body sealing areas		Partial clad - SS316 weld overlay on all body sealing areas	
24. Valve Testing	FAT according A.9.3		FAT according A.9.3		FAT according A.9.3		FAT according A.9.3	
25. Notes	N/A		N/A		N/A		N/A	

Valve Code	VES-150-2-C130		VES-150-2-C136		VES-150-2-C150		VES-150-2-C152	
Specs	B9 B10		B9 B10		B9 B10		B9 B10	
1. Valve Type	Ball		Ball		Ball		Ball	
2. Sealing Type	Soft		Soft		Metal to Metal		Metal to Metal	
3. Valve Specification Level (VSL)	VSL-2		VSL-2		VSL-2		VSL-2	
4. Ball Mouting	2" - 4"	Floating	2" - 4"	Floating	2" - 4"	Floating	2" - 4"	Floating
	6" - 36"	Trunnion	6" - 36"	Trunnion	6" - 36"	Trunnion	6" - 36"	Trunnion
5. Standard	API 6D / IOGP S-562		API 6D / IOGP S-562		API 6D / IOGP S-562		API 6D / IOGP S-562	
6. Size Range (NPS)	2" - 36"		2" - 36"		2" - 36"		2" - 36"	
7. End Connection	2" - 24"	ASME B16.5, RF	2" - 24"	ASME B16.5, RF	2" - 24"	ASME B16.5, RF	2" - 24"	ASME B16.5, RF
	26" - 36"	ASME B16.47 Series A, RF	26" - 36"	ASME B16.47 Series A, RF	26" - 36"	ASME B16.47 Series A, RF	26" - 36"	ASME B16.47 Series A, RF
8. Pressure Class	150		150		150		150	
9. Temperature	0°C to 150°C		0°C to 150°C		0°C to 150°C		0°C to 150°C	
10. Material Class	Carbon Steel		Carbon Steel		Carbon Steel		Carbon Steel	
11. Body Material	ASTM A105 or ASTM A216 Gr WCB + SS316 weld overlay (acc. item A.7.1.7.3)		ASTM A105 or ASTM A216 Gr WCB + SS316 weld overlay (acc. item A.7.1.7.3)		ASTM A105 or ASTM A216 Gr WCB + SS316 weld overlay (acc. item A.7.1.7.3)		ASTM A105 or ASTM A216 Gr WCB + SS316 weld overlay (acc. item A.7.1.7.3)	
12. Obturator Material	AISI 410		AISI 410		AISI 410 + Tungsten carbide coating		AISI 410 + Tungsten carbide coating	
13. Seat Material	AISI 410		AISI 410		AISI 410 + Tungsten carbide coating		AISI 410 + Tungsten carbide coating	
14. Seat Insert	PTFE reinforced with 25% Carbon		PTFE reinforced with 25% Carbon		N/A		N/A	
15. Spring (Seat) Material	UNS N07750		UNS N07750		UNS N07750		UNS N07750	
16. Stem Material	ASTM A276 (UNS S41000)		ASTM A276 (UNS S41000)		ASTM A276 (UNS S41000)		ASTM A276 (UNS S41000)	
17. Seat-Stem Seal	Group D (acc. item A.7.1.5.6)		Group D (acc. item A.7.1.5.6)		Group A (acc. item A.7.1.5.6)		Group A (acc. item A.7.1.5.6)	
18. Operator Type	2" - 4"	Lever	2" - 4"	Lever	2" - 4"	Lever	2" - 4"	Lever
	6" - 36"	Gearbox	6" - 36"	Gearbox	6" - 36"	Gearbox	6" - 36"	Gearbox
19. Additional Requirement	N/A		N/A		N/A		N/A	
20. Seat Type	Side A: SPE / Side B: SPE		Side A: SPE / Side B: DPE; DIB-2 & DBB		Side A: SPE / Side B: SPE		Side A: SPE / Side B: DPE; DIB-2 & DBB	
21. Bore Type	Full Bore		Full Bore		Full Bore		Full Bore	
22. Body Construction	split body, bolted		split body, bolted		split body, bolted		split body, bolted	
23. Cladding or Coating	Partial clad - SS316 weld overlay on all body sealing areas		Partial clad - SS316 weld overlay on all body sealing areas		Partial clad - SS316 weld overlay on all body sealing areas		Partial clad - SS316 weld overlay on all body sealing areas	
24. Valve Testing	FAT according A.9.3		FAT according A.9.3		FAT according A.9.3		FAT according A.9.3	
25. Notes	N/A		N/A		N/A		N/A	

Valve Code	VES-150-2-C160		VES-150-2-C162		VES-150-2-C170		VES-150-2-C172	
Specs	B4 B9 B10 S9B		B4 B9 B10		B9 B10		B9 B10	
1. Valve Type	Ball		Ball		Ball		Ball	
2. Sealing Type	Metal to Metal		Metal to Metal		Metal to Metal		Metal to Metal	
3. Valve Specification Level (VSL)	VSL-2		VSL-2		VSL-2		VSL-2	
4. Ball Mouting	2" - 4"	Floating	2" - 4"	Floating	2" - 4"	Floating	2" - 4"	Floating
	6" - 36"	Trunnion	6" - 36"	Trunnion	6" - 36"	Trunnion	6" - 36"	Trunnion
5. Standard	API 6D		API 6D		API 6D		API 6D	
6. Size Range (NPS)	2" - 36"		2" - 36"		2" - 36"		2" - 36"	
7. End Connection	2" - 24"	ASME B16.5, RF	2" - 24"	ASME B16.5, RF	2" - 24"	ASME B16.5, RF	2" - 24"	ASME B16.5, RF
	26" - 36"	ASME B16.47 Series A, RF	26" - 36"	ASME B16.47 Series A, RF	26" - 36"	ASME B16.47 Series A, RF	26" - 36"	ASME B16.47 Series A, RF
8. Pressure Class	150		150		150		150	
9. Temperature	0°C to 210°C		0°C to 210°C		0°C to 210°C		0°C to 210°C	
10. Material Class	Carbon Steel		Carbon Steel		Carbon Steel		Carbon Steel	
11. Body Material	ASTM A105 or ASTM A216 Gr WCB + SS316 weld overlay (acc. item A.7.1.7.3)		ASTM A105 or ASTM A216 Gr WCB + SS316 weld overlay (acc. item A.7.1.7.3)		ASTM A105 or ASTM A216 Gr WCB + SS316 weld overlay (acc. item A.7.1.7.3)		ASTM A105 or ASTM A216 Gr WCB + SS316 weld overlay (acc. item A.7.1.7.3)	
12. Obturator Material	AISI 410 + Tungsten carbide coating		AISI 410 + Tungsten carbide coating		AISI 410 + Tungsten carbide coating		AISI 410 + Tungsten carbide coating	
13. Seat Material	AISI 410 + Tungsten carbide coating		AISI 410 + Tungsten carbide coating		AISI 410 + Tungsten carbide coating		AISI 410 + Tungsten carbide coating	
14. Seat Insert	N/A		N/A		N/A		N/A	
15. Spring (Seat) Material	UNS N07750		UNS N07750		UNS N07750		UNS N07750	
16. Stem Material	ASTM A276 (UNS S41000)		ASTM A276 (UNS S41000)		ASTM A276 (UNS S41000)		ASTM A276 (UNS S41000)	
17. Seat-Stem Seal	Group C (acc. item A.7.1.5.6)		Group C (acc. item A.7.1.5.6)		Group D (acc. item A.7.1.5.6)		Group D (acc. item A.7.1.5.6)	
18. Operator Type	2" - 4"	Lever	2" - 4"	Lever	2" - 4"	Lever	2" - 4"	Lever
	6" - 36"	Gearbox	6" - 36"	Gearbox	6" - 36"	Gearbox	6" - 36"	Gearbox
19. Additional Requirement	N/A		N/A		N/A		N/A	
20. Seat Type	Side A: SPE / Side B: SPE		Side A: SPE / Side B: DPE; DIB-2 & DBB		Side A: SPE / Side B: SPE		Side A: SPE / Side B: DPE; DIB-2 & DBB	
21. Bore Type	Full Bore		Full Bore		Full Bore		Full Bore	
22. Body Construction	split body, bolted		split body, bolted		split body, bolted		split body, bolted	
23. Cladding or Coating	Partial clad - SS316 weld overlay on all body sealing areas		Partial clad - SS316 weld overlay on all body sealing areas		Partial clad - SS316 weld overlay on all body sealing areas		Partial clad - SS316 weld overlay on all body sealing areas	
24. Valve Testing	FAT according A.9.3		FAT according A.9.3		FAT according A.9.3		FAT according A.9.3	
25. Notes	N/A		N/A		N/A		N/A	

Valve Code	VES-150-2-C180		VES-150-2-C182		VES-150-2-C210		VES-150-2-C216	
Specs	B9 B10		B9 B10		B6 B19		B6 B19	
1. Valve Type	Ball		Ball		Ball		Ball	
2. Sealing Type	Metal to Metal		Metal to Metal		Soft		Soft	
3. Valve Specification Level (VSL)	VSL-2		VSL-2		VSL-2		VSL-2	
4. Ball Mouting	2" - 4"	Floating	2" - 4"	Floating	2" - 4"	Floating	2" - 4"	Floating
	6" - 36"	Trunnion	6" - 36"	Trunnion	6" - 36"	Trunnion	6" - 36"	Trunnion
5. Standard	API 6D		API 6D		API 6D / IOGP S-562		API 6D / IOGP S-562	
6. Size Range (NPS)	2" - 36"		2" - 36"		2" - 36"		2" - 36"	
7. End Connection	2" - 24"	ASME B16.5, RF	2" - 24"	ASME B16.5, RF	2" - 24"	ASME B16.5, RF	2" - 24"	ASME B16.5, RF
	26" - 36"	ASME B16.47 Series A, RF	26" - 36"	ASME B16.47 Series A, RF	26" - 36"	ASME B16.47 Series A, RF	26" - 36"	ASME B16.47 Series A, RF
8. Pressure Class	150		150		150		150	
9. Temperature	0°C to 400°C		0°C to 400°C		-30°C to 150°C		-30°C to 150°C	
10. Material Class	Carbon Steel		Carbon Steel		Carbon Steel		Carbon Steel	
11. Body Material	ASTM A105 or ASTM A216 Gr WCB + SS316 weld overlay (acc. item A.7.1.7.3)		ASTM A105 or ASTM A216 Gr WCB + SS316 weld overlay (acc. item A.7.1.7.3)		ASTM A350 Gr LF2 CL1 or ASTM A352 Gr LCB + Inconel 625 weld overlay (acc. item A.7.1.7.3)		ASTM A350 Gr LF2 CL1 or ASTM A352 Gr LCB + Inconel 625 weld overlay (acc. item A.7.1.7.3)	
12. Obturator Material	AISI 410 + Chrome-Nickel Spray and Fuse (acc. Item A.8.2.2.4)		AISI 410 + Chrome-Nickel Spray and Fuse (acc. Item A.8.2.2.4)		AISI 316		AISI 316	
13. Seat Material	AISI 410 + Chrome-Nickel Spray and Fuse (acc. Item A.8.2.2.4)		AISI 410 + Chrome-Nickel Spray and Fuse (acc. Item A.8.2.2.4)		AISI 316		AISI 316	
14. Seat Insert	N/A		N/A		PTFE reinforced with 25% Carbon		PTFE reinforced with 25% Carbon	
15. Spring (Seat) Material	UNS N07750		UNS N07750		UNS N07750		UNS N07750	
16. Stem Material	ASTM A276 (UNS S41000)		ASTM A276 (UNS S41000)		ASTM A276 (UNS S31600)		ASTM A276 (UNS S31600)	
17. Seat-Stem Seal	Group F (acc. item A.7.1.5.6)		Group F (acc. item A.7.1.5.6)		Group B (acc. item A.7.1.5.6)		Group B (acc. item A.7.1.5.6)	
18. Operator Type	2" - 4"	Lever	2" - 4"	Lever	2" - 4"	Lever	2" - 4"	Lever
	6" - 36"	Gearbox	6" - 36"	Gearbox	6" - 36"	Gearbox	6" - 36"	Gearbox
19. Additional Requirement	N/A		N/A		N/A		N/A	
20. Seat Type	Side A: SPE / Side B: SPE		Side A: SPE / Side B: DPE; DIB-2 & DBB		Side A: SPE / Side B: SPE		Side A: SPE / Side B: DPE; DIB-2 & DBB	
21. Bore Type	Full Bore		Full Bore		Full Bore		Full Bore	
22. Body Construction	split body, bolted		split body, bolted		split body, bolted		split body, bolted	
23. Cladding or Coating	Partial clad - SS316 weld overlay on all body sealing areas		Partial clad - SS316 weld overlay on all body sealing areas		Partial clad - Inconel 625 weld overlay on all body sealing areas		Partial clad - Inconel 625 weld overlay on all body sealing areas	
24. Valve Testing	FAT according A.9.3		FAT according A.9.3		FAT according A.9.3		FAT according A.9.3	
25. Notes	N/A		N/A		N/A		N/A	

Valve Code	VES-150-2-C230		VES-150-2-C236		VES-150-2-C250		VES-150-2-C252	
Specs	B6 B19		B6 B19		B6 B19		B6 B19	
1. Valve Type	Ball		Ball		Ball		Ball	
2. Sealing Type	Soft		Soft		Metal to Metal		Metal to Metal	
3. Valve Specification Level (VSL)	VSL-2		VSL-2		VSL-2		VSL-2	
4. Ball Mouting	2" - 4"	Floating	2" - 4"	Floating	2" - 4"	Floating	2" - 4"	Floating
	6" - 36"	Trunnion	6" - 36"	Trunnion	6" - 36"	Trunnion	6" - 36"	Trunnion
5. Standard	API 6D / IOGP S-562		API 6D / IOGP S-562		API 6D / IOGP S-562		API 6D / IOGP S-562	
6. Size Range (NPS)	2" - 36"		2" - 36"		2" - 36"		2" - 36"	
7. End Connection	2" - 24"	ASME B16.5, RF	2" - 24"	ASME B16.5, RF	2" - 24"	ASME B16.5, RF	2" - 24"	ASME B16.5, RF
	26" - 36"	ASME B16.47 Series A, RF	26" - 36"	ASME B16.47 Series A, RF	26" - 36"	ASME B16.47 Series A, RF	26" - 36"	ASME B16.47 Series A, RF
8. Pressure Class	150		150		150		150	
9. Temperature	-46°C to 150°C		-46°C to 150°C		-30°C to 150°C		-30°C to 150°C	
10. Material Class	Carbon Steel		Carbon Steel		Carbon Steel		Carbon Steel	
11. Body Material	ASTM A350 Gr LF2 CL1 or ASTM A352 Gr LCB + Inconel 625 weld overlay (acc. item A.7.1.7.3)		ASTM A350 Gr LF2 CL1 or ASTM A352 Gr LCB + Inconel 625 weld overlay (acc. item A.7.1.7.3)		ASTM A350 Gr LF2 CL1 or ASTM A352 Gr LCB + Inconel 625 weld overlay (acc. item A.7.1.7.3)		ASTM A350 Gr LF2 CL1 or ASTM A352 Gr LCB + Inconel 625 weld overlay (acc. item A.7.1.7.3)	
12. Obturator Material	AISI 316		AISI 316		AISI 316 + Tungsten carbide coating		AISI 316 + Tungsten carbide coating	
13. Seat Material	AISI 316		AISI 316		AISI 316 + Tungsten carbide coating		AISI 316 + Tungsten carbide coating	
14. Seat Insert	PTFE reinforced with 25% Carbon		PTFE reinforced with 25% Carbon		N/A		N/A	
15. Spring (Seat) Material	UNS N07750		UNS N07750		UNS N07750		UNS N07750	
16. Stem Material	ASTM A276 (UNS S31600)		ASTM A276 (UNS S31600)		ASTM A276 (UNS S31600)		ASTM A276 (UNS S31600)	
17. Seat-Stem Seal	Group E (acc. item A.7.1.5.6)		Group E (acc. item A.7.1.5.6)		Group B (acc. item A.7.1.5.6)		Group B (acc. item A.7.1.5.6)	
18. Operator Type	2" - 4"	Lever	2" - 4"	Lever	2" - 4"	Lever	2" - 4"	Lever
	6" - 36"	Gearbox	6" - 36"	Gearbox	6" - 36"	Gearbox	6" - 36"	Gearbox
19. Additional Requirement	N/A		N/A		N/A		N/A	
20. Seat Type	Side A: SPE / Side B: SPE		Side A: SPE / Side B: DPE; DIB-2 & DBB		Side A: SPE / Side B: SPE		Side A: SPE / Side B: DPE; DIB-2 & DBB	
21. Bore Type	Full Bore		Full Bore		Full Bore		Full Bore	
22. Body Construction	split body, bolted		split body, bolted		split body, bolted		split body, bolted	
23. Cladding or Coating	Partial clad - Inconel 625 weld overlay on all body sealing areas		Partial clad - Inconel 625 weld overlay on all body sealing areas		Partial clad - Inconel 625 weld overlay on all body sealing areas		Partial clad - Inconel 625 weld overlay on all body sealing areas	
24. Valve Testing	FAT according A.9.3		FAT according A.9.3		FAT according A.9.3		FAT according A.9.3	
25. Notes	N/A		N/A		N/A		N/A	

Valve Code	VES-150-2-C270		VES-150-2-C272		VES-150-2-C280		VES-150-2-C282	
Specs	B6 B19		B6 B19		B6 B19		B6 B19	
1. Valve Type	Ball		Ball		Ball		Ball	
2. Sealing Type	Metal to Metal		Metal to Metal		Metal to Metal		Metal to Metal	
3. Valve Specification Level (VSL)	VSL-2		VSL-2		VSL-2		VSL-2	
4. Ball Mouting	2" - 4"	Floating	2" - 4"	Floating	2" - 4"	Floating	2" - 4"	Floating
	6" - 36"	Trunnion	6" - 36"	Trunnion	6" - 36"	Trunnion	6" - 36"	Trunnion
5. Standard	API 6D		API 6D		API 6D		API 6D	
6. Size Range (NPS)	2" - 36"		2" - 36"		2" - 36"		2" - 36"	
7. End Connection	2" - 24"	ASME B16.5, RF	2" - 24"	ASME B16.5, RF	2" - 24"	ASME B16.5, RF	2" - 24"	ASME B16.5, RF
	26" - 36"	ASME B16.47 Series A, RF	26" - 36"	ASME B16.47 Series A, RF	26" - 36"	ASME B16.47 Series A, RF	26" - 36"	ASME B16.47 Series A, RF
8. Pressure Class	150		150		150		150	
9. Temperature	-100°C to 200°C		-100°C to 200°C		-100°C to 345°C		-100°C to 345°C	
10. Material Class	Carbon Steel		Carbon Steel		Carbon Steel		Carbon Steel	
11. Body Material	ASTM A350 Gr LF2 CL1 or ASTM A352 Gr LCB + Inconel 625 weld overlay (acc. item A.7.1.7.3)		ASTM A350 Gr LF2 CL1 or ASTM A352 Gr LCB + Inconel 625 weld overlay (acc. item A.7.1.7.3)		ASTM A350 Gr LF2 CL1 or ASTM A352 Gr LCB + Inconel 625 weld overlay (acc. item A.7.1.7.3)		ASTM A350 Gr LF2 CL1 or ASTM A352 Gr LCB + Inconel 625 weld overlay (acc. item A.7.1.7.3)	
12. Obturator Material	AISI 316 + Tungsten carbide coating		AISI 316 + Tungsten carbide coating		AISI 316 + Chrome-Nickel Spray and Fuse (acc. Item A.8.2.2.4)		AISI 316 + Chrome-Nickel Spray and Fuse (acc. Item A.8.2.2.4)	
13. Seat Material	AISI 316 + Tungsten carbide coating		AISI 316 + Tungsten carbide coating		AISI 316 + Chrome-Nickel Spray and Fuse (acc. Item A.8.2.2.4)		AISI 316 + Chrome-Nickel Spray and Fuse (acc. Item A.8.2.2.4)	
14. Seat Insert	N/A		N/A		N/A		N/A	
15. Spring (Seat) Material	UNS N07750		UNS N07750		UNS N07750		UNS N07750	
16. Stem Material	ASTM A276 (UNS S31600)		ASTM A276 (UNS S31600)		ASTM A276 (UNS S31600)		ASTM A276 (UNS S31600)	
17. Seat-Stem Seal	Group E (acc. item A.7.1.5.6)		Group E (acc. item A.7.1.5.6)		Group F (acc. item A.7.1.5.6)		Group F (acc. item A.7.1.5.6)	
18. Operator Type	2" - 4"	Lever	2" - 4"	Lever	2" - 4"	Lever	2" - 4"	Lever
	6" - 36"	Gearbox	6" - 36"	Gearbox	6" - 36"	Gearbox	6" - 36"	Gearbox
19. Additional Requirement	N/A		N/A		N/A		N/A	
20. Seat Type	Side A: SPE / Side B: SPE		Side A: SPE / Side B: DPE; DIB-2 & DBB		Side A: SPE / Side B: SPE		Side A: SPE / Side B: DPE; DIB-2 & DBB	
21. Bore Type	Full Bore		Full Bore		Full Bore		Full Bore	
22. Body Construction	split body, bolted		split body, bolted		split body, bolted		split body, bolted	
23. Cladding or Coating	Partial clad - Inconel 625 weld overlay on all body sealing areas		Partial clad - Inconel 625 weld overlay on all body sealing areas		Partial clad - Inconel 625 weld overlay on all body sealing areas		Partial clad - Inconel 625 weld overlay on all body sealing areas	
24. Valve Testing	FAT according A.9.3		FAT according A.9.3		FAT according A.9.3		FAT according A.9.3	
25. Notes	N/A		N/A		N/A		N/A	

Valve Code	VES-150-2-C510		VES-150-2-C520		VES-150-2-C526		VES-150-2-C530	
Specs	B30		B30		B30		B30	
1. Valve Type	Ball		Ball		Ball		Ball	
2. Sealing Type	Soft		Soft		Soft		Soft	
3. Valve Specification Level (VSL)	VSL-2		VSL-2		VSL-2		VSL-2	
4. Ball Mouting	2" - 4"	Floating	2" - 4"	Floating	2" - 4"	Floating	2" - 4"	Floating
	6" - 30"	Trunnion	6" - 30"	Trunnion	6" - 30"	Trunnion	6" - 30"	Trunnion
5. Standard	API 6D / IOGP S-562		API 6D / IOGP S-562		API 6D / IOGP S-562		API 6D / IOGP S-562	
6. Size Range (NPS)	2" - 30"		2" - 30"		2" - 30"		2" - 30"	
7. End Connection	2" - 24"	ASME B16.5, RF	2" - 24"	ASME B16.5, RF	2" - 24"	ASME B16.5, RF	2" - 24"	ASME B16.5, RF
	26" - 30"	ASME B16.47 Series A, RF	26" - 30"	ASME B16.47 Series A, RF	26" - 30"	ASME B16.47 Series A, RF	26" - 30"	ASME B16.47 Series A, RF
8. Pressure Class	150		150		150		150	
9. Temperature	-29°C to 150°C		0°C to 150°C		0°C to 150°C		0°C to 150°C	
10. Material Class	Carbon Steel		Carbon Steel		Carbon Steel		Carbon Steel	
11. Body Material	ASTM A105 or ASTM A216 Gr WCB + Inconel 625 weld overlay (acc. item A.7.1.7.3)		ASTM A105 or ASTM A216 Gr WCB + Inconel 625 weld overlay (acc. item A.7.1.7.3)		ASTM A105 or ASTM A216 Gr WCB + Inconel 625 weld overlay (acc. item A.7.1.7.3)		ASTM A105 or ASTM A216 Gr WCB + Inconel 625 weld overlay (acc. item A.7.1.7.3)	
12. Obturator Material	ASTM A105 + Inconel 625 weld overlay (acc. item A.7.1.7.3)		ASTM A105 + Inconel 625 weld overlay (acc. item A.7.1.7.3)		ASTM A105 + Inconel 625 weld overlay (acc. item A.7.1.7.3)		ASTM A105 + Inconel 625 weld overlay (acc. item A.7.1.7.3)	
13. Seat Material	ASTM A105 + Inconel 625 weld overlay (acc. item A.7.1.7.3)		ASTM A105 + Inconel 625 weld overlay (acc. item A.7.1.7.3)		ASTM A105 + Inconel 625 weld overlay (acc. item A.7.1.7.3)		ASTM A105 + Inconel 625 weld overlay (acc. item A.7.1.7.3)	
14. Seat Insert	PTFE reinforced with 25% Carbon		PTFE reinforced with 25% Carbon		PTFE reinforced with 25% Carbon		PTFE reinforced with 25% Carbon	
15. Spring (Seat) Material	UNS N07750		UNS N07750		UNS N07750		UNS N07750	
16. Stem Material	ASTM B637 (UNS N07718)		ASTM B637 (UNS N07718)		ASTM B637 (UNS N07718)		ASTM B637 (UNS N07718)	
17. Seat-Stem Seal	Group B (acc. item A.7.1.5.6)		Group C (acc. item A.7.1.5.6)		Group C (acc. item A.7.1.5.6)		Group D (acc. item A.7.1.5.6)	
18. Operator Type	2" - 4"	Lever	2" - 4"	Lever	2" - 4"	Lever	2" - 4"	Lever
	6" - 30"	Gearbox	6" - 30"	Gearbox	6" - 30"	Gearbox	6" - 30"	Gearbox
19. Additional Requirement	N/A		N/A		N/A		N/A	
20. Seat Type	Side A: SPE / Side B: SPE		Side A: SPE / Side B: SPE		Side A: SPE / Side B: DPE; DIB-2 & DBB		Side A: SPE / Side B: SPE	
21. Bore Type	Full Bore		Full Bore		Full Bore		Full Bore	
22. Body Construction	split body, bolted		split body, bolted		split body, bolted		split body, bolted	
23. Cladding or Coating	Full clad - Inconel 625 weld overlay on all wetted parts		Full clad - Inconel 625 weld overlay on all wetted parts		Full clad - Inconel 625 weld overlay on all wetted parts		Full clad - Inconel 625 weld overlay on all wetted parts	
24. Valve Testing	FAT according A.9.3		FAT according A.9.3		FAT according A.9.3		FAT according A.9.3	
25. Notes	N/A		N/A		N/A		N/A	

Valve Code	VES-150-2-C536		VES-150-2-C560		VES-150-2-C562		VES-150-2-C570	
Specs	B30		B30		B30		B30	
1. Valve Type	Ball		Ball		Ball		Ball	
2. Sealing Type	Soft		Metal to Metal		Metal to Metal		Metal to Metal	
3. Valve Specification Level (VSL)	VSL-2		VSL-2		VSL-2		VSL-2	
4. Ball Mouting	2" - 4"	Floating	2" - 4"	Floating	2" - 4"	Floating	2" - 4"	Floating
	6" - 30"	Trunnion	6" - 30"	Trunnion	6" - 30"	Trunnion	6" - 30"	Trunnion
5. Standard	API 6D / IOGP S-562		API 6D		API 6D		API 6D	
6. Size Range (NPS)	2" - 30"		2" - 30"		2" - 30"		2" - 30"	
7. End Connection	2" - 24"	ASME B16.5, RF	2" - 24"	ASME B16.5, RF	2" - 24"	ASME B16.5, RF	2" - 24"	ASME B16.5, RF
	26" - 30"	ASME B16.47 Series A, RF	26" - 30"	ASME B16.47 Series A, RF	26" - 30"	ASME B16.47 Series A, RF	26" - 30"	ASME B16.47 Series A, RF
8. Pressure Class	150		150		150		150	
9. Temperature	0°C to 150°C		0°C to 210°C		0°C to 210°C		0°C to 210°C	
10. Material Class	Carbon Steel		Carbon Steel		Carbon Steel		Carbon Steel	
11. Body Material	ASTM A105 or ASTM A216 Gr WCB + Inconel 625 weld overlay (acc. item A.7.1.7.3)		ASTM A105 or ASTM A216 Gr WCB + Inconel 625 weld overlay (acc. item A.7.1.7.3)		ASTM A105 or ASTM A216 Gr WCB + Inconel 625 weld overlay (acc. item A.7.1.7.3)		ASTM A105 or ASTM A216 Gr WCB + Inconel 625 weld overlay (acc. item A.7.1.7.3)	
12. Obturator Material	ASTM A105 + Inconel 625 weld overlay (acc. item A.7.1.7.3)		ASTM A105 + Inconel 625 weld overlay (acc. item A.7.1.7.3) + Tungsten carbide coating		ASTM A105 + Inconel 625 weld overlay (acc. item A.7.1.7.3) + Tungsten carbide coating		ASTM A105 + Inconel 625 weld overlay (acc. item A.7.1.7.3) + Tungsten carbide coating	
13. Seat Material	ASTM A105 + Inconel 625 weld overlay (acc. item A.7.1.7.3)		ASTM A105 + Inconel 625 weld overlay (acc. item A.7.1.7.3) + Tungsten carbide coating		ASTM A105 + Inconel 625 weld overlay (acc. item A.7.1.7.3) + Tungsten carbide coating		ASTM A105 + Inconel 625 weld overlay (acc. item A.7.1.7.3) + Tungsten carbide coating	
14. Seat Insert	PTFE reinforced with 25% Carbon		N/A		N/A		N/A	
15. Spring (Seat) Material	UNS N07750		UNS N07750		UNS N07750		UNS N07750	
16. Stem Material	ASTM B637 (UNS N07718)		ASTM B637 (UNS N07718)		ASTM B637 (UNS N07718)		ASTM B637 (UNS N07718)	
17. Seat-Stem Seal	Group D (acc. item A.7.1.5.6)		Group C (acc. item A.7.1.5.6)		Group C (acc. item A.7.1.5.6)		Group D (acc. item A.7.1.5.6)	
18. Operator Type	2" - 4"	Lever	2" - 4"	Lever	2" - 4"	Lever	2" - 4"	Lever
	6" - 30"	Gearbox	6" - 30"	Gearbox	6" - 30"	Gearbox	6" - 30"	Gearbox
19. Additional Requirement	N/A		N/A		N/A		N/A	
20. Seat Type	Side A: SPE / Side B: DPE; DIB-2 & DBB		Side A: SPE / Side B: SPE		Side A: SPE / Side B: DPE; DIB-2 & DBB		Side A: SPE / Side B: SPE	
21. Bore Type	Full Bore		Full Bore		Full Bore		Full Bore	
22. Body Construction	split body, bolted		split body, bolted		split body, bolted		split body, bolted	
23. Cladding or Coating	Full clad - Inconel 625 weld overlay on all wetted parts		Full clad - Inconel 625 weld overlay on all wetted parts		Full clad - Inconel 625 weld overlay on all wetted parts		Full clad - Inconel 625 weld overlay on all wetted parts	
24. Valve Testing	FAT according A.9.3		FAT according A.9.3		FAT according A.9.3		FAT according A.9.3	
25. Notes	N/A		N/A		N/A		N/A	

Valve Code	VES-150-2-C572		VES-150-2-C580		VES-150-2-D110		VES-150-2-D200
Specs	B30		B30		B11 B26		B11 B26
1. Valve Type	Ball		Ball		Ball		Ball
2. Sealing Type	Metal to Metal		Metal to Metal		Soft		Soft
3. Valve Specification Level (VSL)	VSL-2		VSL-2		VSL-2		VSL-2
4. Ball Mouting	2" - 4"	Floating	2" - 4"	Floating	2" - 4"	Floating	N/A
	6" - 30"	Trunnion	6" - 30"	Trunnion	6" - 28"	Trunnion	N/A
5. Standard	API 6D		API 6D		API 6D / IOGP S-562		API 6D
6. Size Range (NPS)	2" - 30"		2" - 30"		2" - 28"		1" - 1 1/2"
7. End Connection	2" - 24"	ASME B16.5, RF	2" - 24"	ASME B16.5, RF	2" - 24"	ASME B16.5, RF	N/A
	26" - 30"	ASME B16.47 Series A, RF	26" - 30"	ASME B16.47 Series A, RF	26" - 28"	ASME B16.47 Series A, RF	N/A
8. Pressure Class	150		150		150		150
9. Temperature	0°C to 210°C		0°C to 340°C		-30°C to 150°C		0°C to 150°C
10. Material Class	Carbon Steel		Carbon Steel		Duplex Steel		Duplex Steel
11. Body Material	ASTM A105 or ASTM A216 Gr WCB + Inconel 625 weld overlay (acc. item A.7.1.7.3)		ASTM A105 or ASTM A216 Gr WCB + Inconel 625 weld overlay (acc. item A.7.1.7.3)		ASTM A995 Gr 1b		ASTM A182 Gr F51
12. Obturator Material	ASTM A105 + Inconel 625 weld overlay (acc. item A.7.1.7.3) + Tungsten carbide coating		ASTM A105 + Inconel 625 weld overlay (acc. item A.7.1.7.3) + Chrome-Nickel Spray and Fuse (acc. Item A.8.2.2.4)		Duplex (UNS S32550)		Duplex (UNS S31803)
13. Seat Material	ASTM A105 + Inconel 625 weld overlay (acc. item A.7.1.7.3) + Tungsten carbide coating		ASTM A105 + Inconel 625 weld overlay (acc. item A.7.1.7.3) + Chrome-Nickel Spray and Fuse (acc. Item A.8.2.2.4)		Duplex (UNS S32550)		PTFE reinforced with 25% Carbon
14. Seat Insert	N/A		N/A		PTFE reinforced with 25% Carbon		N/A
15. Spring (Seat) Material	UNS N07750		UNS N07750		UNS N07750		N/A
16. Stem Material	ASTM B637 (UNS N07718)		ASTM B637 (UNS N07718)		ASTM A276 (UNS S32550)		ASTM A276 (UNS S31803)
17. Seat-Stem Seal	Group D (acc. item A.7.1.5.6)		Group F (acc. item A.7.1.5.6)		Group B (acc. item A.7.1.5.6)		Group A (acc. item A.7.1.5.6)
18. Operator Type	2" - 4"	Lever	2" - 4"	Lever	2" - 4"	Lever	N/A
	6" - 30"	Gearbox	6" - 30"	Gearbox	6" - 28"	Gearbox	N/A
19. Additional Requirement	N/A		N/A		N/A		Fire Tested (acc. item A.6.1.4)
20. Seat Type	Side A: SPE / Side B: DPE; DIB-2 & DBB		Side A: SPE / Side B: SPE		Side A: SPE / Side B: SPE		N/A
21. Bore Type	Full Bore		Full Bore		Full Bore		Full Bore
22. Body Construction	split body, bolted		split body, bolted		split body, bolted		split body, bolted
23. Cladding or Coating	Full clad - Inconel 625 weld overlay on all wetted parts		Full clad - Inconel 625 weld overlay on all wetted parts		N/A		N/A
24. Valve Testing	FAT according A.9.3		FAT according A.9.3		FAT according A.9.3		FAT according A.9.3
25. Notes	N/A		N/A		N/A		N/A

Valve Code	VES-150-2-D210		VES-150-2-D216		VES-150-2-D220		VES-150-2-D226	
Specs	B11 B16 B26		B16		B16		B16	
1. Valve Type	Ball		Ball		Ball		Ball	
2. Sealing Type	Soft		Soft		Soft		Soft	
3. Valve Specification Level (VSL)	VSL-2		VSL-2		VSL-2		VSL-2	
4. Ball Mouting	2" - 4"	Floating	2" - 4"	Floating	2" - 4"	Floating	2" - 4"	Floating
	6" - 32"	Trunnion	6" - 32"	Trunnion	6" - 32"	Trunnion	6" - 32"	Trunnion
5. Standard	API 6D / IOGP S-562		API 6D / IOGP S-562		API 6D / IOGP S-562		API 6D / IOGP S-562	
6. Size Range (NPS)	2" - 32"		2" - 32"		2" - 32"		2" - 32"	
7. End Connection	2" - 24"	ASME B16.5, RF	2" - 24"	ASME B16.5, RF	2" - 24"	ASME B16.5, RF	2" - 24"	ASME B16.5, RF
	26" - 32"	ASME B16.47 Series A, RF	26" - 32"	ASME B16.47 Series A, RF	26" - 32"	ASME B16.47 Series A, RF	26" - 32"	ASME B16.47 Series A, RF
8. Pressure Class	150		150		150		150	
9. Temperature	-30°C to 150°C		-30°C to 150°C		0°C to 150°C		0°C to 150°C	
10. Material Class	Duplex Steel		Duplex Steel		Duplex Steel		Duplex Steel	
11. Body Material	ASTM A182 Gr F51 or ASTM A995 Gr 4a		ASTM A182 Gr F51 or ASTM A995 Gr 4a		ASTM A182 Gr F51 or ASTM A995 Gr 4a		ASTM A182 Gr F51 or ASTM A995 Gr 4a	
12. Obturator Material	Duplex (UNS S31803)		Duplex (UNS S31803)		Duplex (UNS S31803)		Duplex (UNS S31803)	
13. Seat Material	Duplex (UNS S31803)		Duplex (UNS S31803)		Duplex (UNS S31803)		Duplex (UNS S31803)	
14. Seat Insert	PTFE reinforced with 25% Carbon		PTFE reinforced with 25% Carbon		PTFE reinforced with 25% Carbon		PTFE reinforced with 25% Carbon	
15. Spring (Seat) Material	UNS N07750		UNS N07750		UNS N07750		UNS N07750	
16. Stem Material	ASTM A276 (UNS S31803)		ASTM A276 (UNS S31803)		ASTM A276 (UNS S31803)		ASTM A276 (UNS S31803)	
17. Seat-Stem Seal	Group B (acc. item A.7.1.5.6)		Group B (acc. item A.7.1.5.6)		Group C (acc. item A.7.1.5.6)		Group C (acc. item A.7.1.5.6)	
18. Operator Type	2" - 4"	Lever	2" - 4"	Lever	2" - 4"	Lever	2" - 4"	Lever
	6" - 32"	Gearbox	6" - 32"	Gearbox	6" - 32"	Gearbox	6" - 32"	Gearbox
19. Additional Requirement	N/A		N/A		N/A		N/A	
20. Seat Type	Side A: SPE / Side B: SPE		Side A: SPE / Side B: DPE; DIB-2 & DBB		Side A: SPE / Side B: SPE		Side A: SPE / Side B: DPE; DIB-2 & DBB	
21. Bore Type	Full Bore		Full Bore		Full Bore		Full Bore	
22. Body Construction	split body, bolted		split body, bolted		split body, bolted		split body, bolted	
23. Cladding or Coating	N/A		N/A		N/A		N/A	
24. Valve Testing	FAT according A.9.3		FAT according A.9.3		FAT according A.9.3		FAT according A.9.3	
25. Notes	N/A		N/A		N/A		N/A	

Valve Code	VES-150-2-D230		VES-150-2-D236		VES-150-2-D310		VES-150-2-D330	
Specs	B11 B16 B26		B16		B12		B12	
1. Valve Type	Ball		Ball		Ball		Ball	
2. Sealing Type	Soft		Soft		Soft		Soft	
3. Valve Specification Level (VSL)	VSL-2		VSL-2		VSL-2		VSL-2	
4. Ball Mouting	2" - 4"	Floating	2" - 4"	Floating	2" - 4"	Floating	2" - 4"	Floating
	6" - 32"	Trunnion	6" - 32"	Trunnion	6" - 36"	Trunnion	6" - 36"	Trunnion
5. Standard	API 6D / IOGP S-562		API 6D / IOGP S-562		API 6D / IOGP S-562		API 6D / IOGP S-562	
6. Size Range (NPS)	2" - 32"		2" - 32"		2" - 36"		2" - 36"	
7. End Connection	2" - 24"	ASME B16.5, RF	2" - 24"	ASME B16.5, RF	2" - 24"	ASME B16.5, RF	2" - 24"	ASME B16.5, RF
	26" - 32"	ASME B16.47 Series A, RF	26" - 32"	ASME B16.47 Series A, RF	26" - 36"	ASME B16.47 Series A, RF	26" - 36"	ASME B16.47 Series A, RF
8. Pressure Class	150		150		150		150	
9. Temperature	-46°C to 150°C		-46°C to 150°C		-30°C to 150°C		0°C to 150°C	
10. Material Class	Duplex Steel		Duplex Steel		Duplex Steel		Duplex Steel	
11. Body Material	ASTM A182 Gr F51 or ASTM A995 Gr 4a		ASTM A182 Gr F51 or ASTM A995 Gr 4a		ASTM A182 Gr F55 or ASTM A995 Gr 6a		ASTM A182 Gr F55 or ASTM A995 Gr 6a	
12. Obturator Material	Duplex (UNS S31803)		Duplex (UNS S31803)		Super Duplex (UNS S32760)		Super Duplex (UNS S32760)	
13. Seat Material	Duplex (UNS S31803)		Duplex (UNS S31803)		Super Duplex (UNS S32760)		Super Duplex (UNS S32760)	
14. Seat Insert	PTFE reinforced with 25% Carbon		PTFE reinforced with 25% Carbon		PTFE reinforced with 25% Carbon		PTFE reinforced with 25% Carbon	
15. Spring (Seat) Material	UNS N07750		UNS N07750		UNS N07750		UNS N07750	
16. Stem Material	ASTM A276 (UNS S31803)		ASTM A276 (UNS S31803)		ASTM A276 (UNS S32760)		ASTM A276 (UNS S32760)	
17. Seat-Stem Seal	Group E (acc. item A.7.1.5.6)		Group E (acc. item A.7.1.5.6)		Group B (acc. item A.7.1.5.6)		Group D (acc. item A.7.1.5.6)	
18. Operator Type	2" - 4"	Lever	2" - 4"	Lever	2" - 4"	Lever	2" - 4"	Lever
	6" - 32"	Gearbox	6" - 32"	Gearbox	6" - 36"	Gearbox	6" - 36"	Gearbox
19. Additional Requirement	N/A		N/A		N/A		N/A	
20. Seat Type	Side A: SPE / Side B: SPE		Side A: SPE / Side B: DPE; DIB-2 & DBB		Side A: SPE / Side B: SPE		Side A: SPE / Side B: SPE	
21. Bore Type	Full Bore		Full Bore		Full Bore		Full Bore	
22. Body Construction	split body, bolted		split body, bolted		split body, bolted		split body, bolted	
23. Cladding or Coating	N/A		N/A		N/A		N/A	
24. Valve Testing	FAT according A.9.3		FAT according A.9.3		FAT according A.9.3		FAT according A.9.3	
25. Notes	N/A		N/A		N/A		N/A	

Valve Code	VES-150-2-S210		VES-150-2-S216		VES-150-2-S220		VES-150-2-S226	
Specs	B3		B3		B3		B3	
1. Valve Type	Ball		Ball		Ball		Ball	
2. Sealing Type	Soft		Soft		Soft		Soft	
3. Valve Specification Level (VSL)	VSL-2		VSL-2		VSL-2		VSL-2	
4. Ball Mouting	2" - 4"	Floating	2" - 4"	Floating	2" - 4"	Floating	2" - 4"	Floating
	6" - 36"	Trunnion	6" - 36"	Trunnion	6" - 36"	Trunnion	6" - 36"	Trunnion
5. Standard	API 6D / IOGP S-562		API 6D / IOGP S-562		API 6D / IOGP S-562		API 6D / IOGP S-562	
6. Size Range (NPS)	2" - 36"		2" - 36"		2" - 36"		2" - 36"	
7. End Connection	2" - 24"	ASME B16.5, RF	2" - 24"	ASME B16.5, RF	2" - 24"	ASME B16.5, RF	2" - 24"	ASME B16.5, RF
	26" - 36"	ASME B16.47 Series A, RF	26" - 36"	ASME B16.47 Series A, RF	26" - 36"	ASME B16.47 Series A, RF	26" - 36"	ASME B16.47 Series A, RF
8. Pressure Class	150		150		150		150	
9. Temperature	-30°C to 150°C		-30°C to 150°C		0°C to 150°C		0°C to 150°C	
10. Material Class	Stainless Steel		Stainless Steel		Stainless Steel		Stainless Steel	
11. Body Material	ASTM A182 Gr F316 or ASTM A351 Gr CF8M		ASTM A182 Gr F316 or ASTM A351 Gr CF8M		ASTM A182 Gr F316 or ASTM A351 Gr CF8M		ASTM A182 Gr F316 or ASTM A351 Gr CF8M	
12. Obturator Material	AISI 316		AISI 316		AISI 316		AISI 316	
13. Seat Material	AISI 316		AISI 316		AISI 316		AISI 316	
14. Seat Insert	PTFE reinforced with 25% Carbon		PTFE reinforced with 25% Carbon		PTFE reinforced with 25% Carbon		PTFE reinforced with 25% Carbon	
15. Spring (Seat) Material	UNS N07750		UNS N07750		UNS N07750		UNS N07750	
16. Stem Material	ASTM A276 (UNS S31600)		ASTM A276 (UNS S31600)		ASTM A276 (UNS S31600)		ASTM A276 (UNS S31600)	
17. Seat-Stem Seal	Group B (acc. item A.7.1.5.6)		Group B (acc. item A.7.1.5.6)		Group C (acc. item A.7.1.5.6)		Group C (acc. item A.7.1.5.6)	
18. Operator Type	2" - 4"	Lever	2" - 4"	Lever	2" - 4"	Lever	2" - 4"	Lever
	6" - 36"	Gearbox	6" - 36"	Gearbox	6" - 36"	Gearbox	6" - 36"	Gearbox
19. Additional Requirement	N/A		N/A		N/A		N/A	
20. Seat Type	Side A: SPE / Side B: SPE		Side A: SPE / Side B: DPE; DIB-2 & DBB		Side A: SPE / Side B: SPE		Side A: SPE / Side B: DPE; DIB-2 & DBB	
21. Bore Type	Full Bore		Full Bore		Full Bore		Full Bore	
22. Body Construction	split body, bolted		split body, bolted		split body, bolted		split body, bolted	
23. Cladding or Coating	N/A		N/A		N/A		N/A	
24. Valve Testing	FAT according A.9.3		FAT according A.9.3		FAT according A.9.3		FAT according A.9.3	
25. Notes	N/A		N/A		N/A		N/A	

Valve Code	VES-150-2-S230		VES-150-2-S236		VES-150-2-S250		VES-150-2-S252	
Specs	B3		B3		B3		B3	
1. Valve Type	Ball		Ball		Ball		Ball	
2. Sealing Type	Soft		Soft		Metal to Metal		Metal to Metal	
3. Valve Specification Level (VSL)	VSL-2		VSL-2		VSL-2		VSL-2	
4. Ball Mouting	2" - 4"	Floating	2" - 4"	Floating	2" - 4"	Floating	2" - 4"	Floating
	6" - 36"	Trunnion	6" - 36"	Trunnion	6" - 36"	Trunnion	6" - 36"	Trunnion
5. Standard	API 6D / IOGP S-562		API 6D / IOGP S-562		API 6D / IOGP S-562		API 6D / IOGP S-562	
6. Size Range (NPS)	2" - 36"		2" - 36"		2" - 36"		2" - 36"	
7. End Connection	2" - 24"	ASME B16.5, RF	2" - 24"	ASME B16.5, RF	2" - 24"	ASME B16.5, RF	2" - 24"	ASME B16.5, RF
	26" - 36"	ASME B16.47 Series A, RF	26" - 36"	ASME B16.47 Series A, RF	26" - 36"	ASME B16.47 Series A, RF	26" - 36"	ASME B16.47 Series A, RF
8. Pressure Class	150		150		150		150	
9. Temperature	-46°C to 150°C		-46°C to 150°C		-30°C to 150°C		-30°C to 150°C	
10. Material Class	Stainless Steel		Stainless Steel		Stainless Steel		Stainless Steel	
11. Body Material	ASTM A182 Gr F316 or ASTM A351 Gr CF8M		ASTM A182 Gr F316 or ASTM A351 Gr CF8M		ASTM A182 Gr F316 or ASTM A351 Gr CF8M		ASTM A182 Gr F316 or ASTM A351 Gr CF8M	
12. Obturator Material	AISI 316		AISI 316		AISI 316 + Tungsten carbide coating		AISI 316 + Tungsten carbide coating	
13. Seat Material	AISI 316		AISI 316		AISI 316 + Tungsten carbide coating		AISI 316 + Tungsten carbide coating	
14. Seat Insert	PTFE reinforced with 25% Carbon		PTFE reinforced with 25% Carbon		N/A		N/A	
15. Spring (Seat) Material	UNS N07750		UNS N07750		UNS N07750		UNS N07750	
16. Stem Material	ASTM A276 (UNS S31600)		ASTM A276 (UNS S31600)		ASTM A276 (UNS S31600)		ASTM A276 (UNS S31600)	
17. Seat-Stem Seal	Group E (acc. item A.7.1.5.6)		Group E (acc. item A.7.1.5.6)		Group B (acc. item A.7.1.5.6)		Group B (acc. item A.7.1.5.6)	
18. Operator Type	2" - 4"	Lever	2" - 4"	Lever	2" - 4"	Lever	2" - 4"	Lever
	6" - 36"	Gearbox	6" - 36"	Gearbox	6" - 36"	Gearbox	6" - 36"	Gearbox
19. Additional Requirement	N/A		N/A		N/A		N/A	
20. Seat Type	Side A: SPE / Side B: SPE		Side A: SPE / Side B: DPE; DIB-2 & DBB		Side A: SPE / Side B: SPE		Side A: SPE / Side B: DPE; DIB-2 & DBB	
21. Bore Type	Full Bore		Full Bore		Full Bore		Full Bore	
22. Body Construction	split body, bolted		split body, bolted		split body, bolted		split body, bolted	
23. Cladding or Coating	N/A		N/A		N/A		N/A	
24. Valve Testing	FAT according A.9.3		FAT according A.9.3		FAT according A.9.3		FAT according A.9.3	
25. Notes	N/A		N/A		N/A		N/A	

Valve Code	VES-150-2-S260		VES-150-2-S262		VES-150-2-S270		VES-150-2-S272	
Specs	B3		B3		B3		B3	
1. Valve Type	Ball		Ball		Ball		Ball	
2. Sealing Type	Metal to Metal		Metal to Metal		Metal to Metal		Metal to Metal	
3. Valve Specification Level (VSL)	VSL-2		VSL-2		VSL-2		VSL-2	
4. Ball Mouting	2" - 4"	Floating	2" - 4"	Floating	2" - 4"	Floating	2" - 4"	Floating
	6" - 36"	Trunnion	6" - 36"	Trunnion	6" - 36"	Trunnion	6" - 36"	Trunnion
5. Standard	API 6D		API 6D		API 6D		API 6D	
6. Size Range (NPS)	2" - 36"		2" - 36"		2" - 36"		2" - 36"	
7. End Connection	2" - 24"	ASME B16.5, RF	2" - 24"	ASME B16.5, RF	2" - 24"	ASME B16.5, RF	2" - 24"	ASME B16.5, RF
	26" - 36"	ASME B16.47 Series A, RF	26" - 36"	ASME B16.47 Series A, RF	26" - 36"	ASME B16.47 Series A, RF	26" - 36"	ASME B16.47 Series A, RF
8. Pressure Class	150		150		150		150	
9. Temperature	0°C to 210°C		0°C to 210°C		-100°C to 200°C		-100°C to 200°C	
10. Material Class	Stainless Steel		Stainless Steel		Stainless Steel		Stainless Steel	
11. Body Material	ASTM A182 Gr F316 or ASTM A351 Gr CF8M		ASTM A182 Gr F316 or ASTM A351 Gr CF8M		ASTM A182 Gr F316 or ASTM A351 Gr CF8M		ASTM A182 Gr F316 or ASTM A351 Gr CF8M	
12. Obturator Material	AISI 316 + Tungsten carbide coating		AISI 316 + Tungsten carbide coating		AISI 316 + Tungsten carbide coating		AISI 316 + Tungsten carbide coating	
13. Seat Material	AISI 316 + Tungsten carbide coating		AISI 316 + Tungsten carbide coating		AISI 316 + Tungsten carbide coating		AISI 316 + Tungsten carbide coating	
14. Seat Insert	N/A		N/A		N/A		N/A	
15. Spring (Seat) Material	UNS N07750		UNS N07750		UNS N07750		UNS N07750	
16. Stem Material	ASTM A276 (UNS S31600)		ASTM A276 (UNS S31600)		ASTM A276 (UNS S31600)		ASTM A276 (UNS S31600)	
17. Seat-Stem Seal	Group C (acc. item A.7.1.5.6)		Group C (acc. item A.7.1.5.6)		Group E (acc. item A.7.1.5.6)		Group E (acc. item A.7.1.5.6)	
18. Operator Type	2" - 4"	Lever	2" - 4"	Lever	2" - 4"	Lever	2" - 4"	Lever
	6" - 36"	Gearbox	6" - 36"	Gearbox	6" - 36"	Gearbox	6" - 36"	Gearbox
19. Additional Requirement	N/A		N/A		N/A		N/A	
20. Seat Type	Side A: SPE / Side B: SPE		Side A: SPE / Side B: DPE; DIB-2 & DBB		Side A: SPE / Side B: SPE		Side A: SPE / Side B: DPE; DIB-2 & DBB	
21. Bore Type	Full Bore		Full Bore		Full Bore		Full Bore	
22. Body Construction	split body, bolted		split body, bolted		split body, bolted		split body, bolted	
23. Cladding or Coating	N/A		N/A		N/A		N/A	
24. Valve Testing	FAT according A.9.3		FAT according A.9.3		FAT according A.9.3		FAT according A.9.3	
25. Notes	N/A		N/A		N/A		N/A	

Valve Code	VES-150-2-S280		VES-150-2-S282		VES-150-2-U300	VES-150-2-U310
Specs	B3		B3		B7R B7 B14 B23	B7R B7 B14 B23
1. Valve Type	Ball		Ball		Ball	Ball
2. Sealing Type	Metal to Metal		Metal to Metal		Soft	Soft
3. Valve Specification Level (VSL)	VSL-2		VSL-2		VSL-2	VSL-2
4. Ball Mouting	2" - 4"	Floating	2" - 4"	Floating	N/A	Floating
	6" - 36"	Trunnion	6" - 36"	Trunnion	N/A	N/A
5. Standard	API 6D		API 6D		API 6D	API 6D / IOGP S-562
6. Size Range (NPS)	2" - 36"		2" - 36"		1" - 1 1/2"	2" - 4"
7. End Connection	2" - 24"	ASME B16.5, RF	2" - 24"	ASME B16.5, RF	ASME B16.5, RF	ASME B16.5, RF
	26" - 36"	ASME B16.47 Series A, RF	26" - 36"	ASME B16.47 Series A, RF	N/A	N/A
8. Pressure Class	150		150		150	150
9. Temperature	-100°C to 400°C		-100°C to 400°C		0°C to 75°C	0°C to 75°C
10. Material Class	Stainless Steel		Stainless Steel		Uncommon Materials	Uncommon Materials
11. Body Material	ASTM A182 Gr F316 or ASTM A351 Gr CF8M		ASTM A182 Gr F316 or ASTM A351 Gr CF8M		ASTM B148 (UNS C95800)	ASTM B148 (UNS C95800)
12. Obturator Material	AISI 316 + Chrome-Nickel Spray and Fuse (acc. Item A.8.2.2.4)		AISI 316 + Chrome-Nickel Spray and Fuse (acc. Item A.8.2.2.4)		ASTM B148 (UNS C95800)	ASTM B148 (UNS C95800)
13. Seat Material	AISI 316 + Chrome-Nickel Spray and Fuse (acc. Item A.8.2.2.4)		AISI 316 + Chrome-Nickel Spray and Fuse (acc. Item A.8.2.2.4)		PTFE reinforced with 25% Carbon	ASTM B148 (UNS C95800)
14. Seat Insert	N/A		N/A		N/A	PTFE reinforced with 25% Carbon
15. Spring (Seat) Material	UNS N07750		UNS N07750		N/A	UNS N07750
16. Stem Material	ASTM A276 (UNS S31600)		ASTM A276 (UNS S31600)		Monel K500	Monel K500
17. Seat-Stem Seal	Group F (acc. item A.7.1.5.6)		Group F (acc. item A.7.1.5.6)		Group A (acc. item A.7.1.5.6)	Group B (acc. item A.7.1.5.6)
18. Operator Type	2" - 4"	Lever	2" - 4"	Lever	N/A	Lever
	6" - 36"	Gearbox	6" - 36"	Gearbox	N/A	N/A
19. Additional Requirement	N/A		N/A		Fire Tested (acc. item A.6.1.4)	N/A
20. Seat Type	Side A: SPE / Side B: SPE		Side A: SPE / Side B: DPE; DIB-2 & DBB		N/A	Side A: SPE / Side B: SPE
21. Bore Type	Full Bore		Full Bore		Full Bore	Full Bore
22. Body Construction	split body, bolted		split body, bolted		split body, bolted	split body, bolted
23. Cladding or Coating	N/A		N/A		N/A	N/A
24. Valve Testing	FAT according A.9.3		FAT according A.9.3		FAT according A.9.3	FAT according A.9.3
25. Notes	N/A		N/A		N/A	N/A

Valve Code	VES-150-2-U311	VES-1503-1-C106	VES-1503-1-C107	VES-1503-1-C206
Specs	B7R B7	F10 G10P	F10 G10P	F6
1. Valve Type	Ball	Ball	Ball	Ball
2. Sealing Type	Soft	Soft	Metal to Metal	Soft
3. Valve Specification Level (VSL)	VSL-2	VSL-1	VSL-1	VSL-1
4. Ball Mouting	Floating	N/A	N/A	N/A
5. Standard	API 6D / IOGP S-562	ASME B16.34 LTD	ASME B16.34 LTD	ASME B16.34 LTD
6. Size Range (NPS)	2" - 4"	½" - 1 ½"	½" - 1 ½"	½" - 1 ½"
7. End Connection	ASME B16.5, RF	N/A	N/A	N/A
8. Pressure Class	150	1500	1500	1500
9. Temperature	0°C to 75°C	0°C to 150°C	0°C to 210°C	-30°C to 150°C
10. Material Class	Uncommon Materials	Carbon Steel	Carbon Steel	Carbon Steel
11. Body Material	ASTM B148 (UNS C95800)	ASTM A105	ASTM A105	ASTM A350 Gr LF2 CL1
12. Obturator Material	ASTM B148 (UNS C95800)	AISI 410	AISI 410 + Hard Coating (acc. Item A.7.1.7.4)	AISI 316
13. Seat Material	ASTM B148 (UNS C95800)	AISI 410	AISI 410 + Hard Coating (acc. Item A.7.1.7.4)	AISI 316
14. Seat Insert	PTFE reinforced with 25% Carbon	PEEK	N/A	PEEK
15. Spring (Seat) Material	UNS N07750	UNS N07750	UNS N07750	UNS N07750
16. Stem Material	Monel K500	ASTM A276 (UNS S41000)	ASTM A276 (UNS S41000)	ASTM A276 (UNS S31803)
17. Seat-Stem Seal	Group B (acc. item A.7.1.5.6)	Group A (acc. item A.7.1.5.6)	Group D (acc. item A.7.1.5.6)	Group B (acc. item A.7.1.5.6)
18. Operator Type	Lever	N/A	N/A	N/A
19. Additional Requirement	Fire Tested (acc. item A.6.1.4)	Fire Tested (acc. item A.6.1.4)	Fire Tested (acc. item A.6.1.4)	Fire Tested (acc. item A.6.1.4)
20. Seat Type	Side A: SPE / Side B: SPE	Side A: SPE / Side B: SPE	Side A: SPE / Side B: SPE	Side A: SPE / Side B: SPE
21. Bore Type	Full Bore	Full Bore	Full Bore	Full Bore
22. Body Construction	split body, bolted	split body, bolted	split body, bolted	split body, bolted
23. Cladding or Coating	N/A	N/A	N/A	N/A
24. Valve Testing	FAT according A.9.3	FAT according A.9.3	FAT according A.9.3	FAT according A.9.3
25. Notes	N/A	N/A	N/A	N/A

Valve Code	VES-1503-1-C207	VES-1503-2-C106	VES-1503-2-C107	VES-1503-2-C206
Specs	F6	F10 G10P	F10 G10P	F6
1. Valve Type	Ball	Ball	Ball	Ball
2. Sealing Type	Metal to Metal	Soft	Metal to Metal	Soft
3. Valve Specification Level (VSL)	VSL-1	VSL-2	VSL-2	VSL-2
4. Ball Mouting	Trunnion	Trunnion	Trunnion	Trunnion
5. Standard	ASME B16.34 LTD	ASME B16.34 LTD	ASME B16.34 LTD	ASME B16.34 LTD
6. Size Range (NPS)	½" - 1 ½"	½" - 1 ½"	½" - 1 ½"	½" - 1 ½"
7. End Connection	socket weld ends ASME B16.11 with nipple SCH 160	socket weld ends ASME B16.11 with nipple SCH 160	socket weld ends ASME B16.11 with nipple SCH 160	socket weld ends ASME B16.11 with nipple SCH 160
8. Pressure Class	1500	1500	1500	1500
9. Temperature	-46°C to 200°C	0°C to 150°C	0°C to 210°C	-30°C to 150°C
10. Material Class	Carbon Steel	Carbon Steel	Carbon Steel	Carbon Steel
11. Body Material	ASTM A350 Gr LF2 CL1	ASTM A105	ASTM A105	ASTM A350 Gr LF2 CL1
12. Obturator Material	AISI 316 + Hard Coating (acc. Item A.7.1.7.4)	AISI 410	AISI 410 + Hard Coating (acc. Item A.7.1.7.4)	AISI 316
13. Seat Material	AISI 316 + Hard Coating (acc. Item A.7.1.7.4)	AISI 410	AISI 410 + Hard Coating (acc. Item A.7.1.7.4)	AISI 316
14. Seat Insert	N/A	PEEK	N/A	PEEK
15. Spring (Seat) Material	UNS N07750	UNS N07750	UNS N07750	UNS N07750
16. Stem Material	ASTM A276 (UNS S31803)	ASTM A276 (UNS S41000)	ASTM A276 (UNS S41000)	ASTM A276 (UNS S31803)
17. Seat-Stem Seal	Group E (acc. item A.7.1.5.6)	Group A (acc. item A.7.1.5.6)	Group D (acc. item A.7.1.5.6)	Group B (acc. item A.7.1.5.6)
18. Operator Type	Lever	Lever	Lever	Lever
19. Additional Requirement	Fire Tested (acc. item A.6.1.4)	Fire Tested (acc. item A.6.1.4)	Fire Tested (acc. item A.6.1.4)	Fire Tested (acc. item A.6.1.4)
20. Seat Type	Side A: SPE / Side B: SPE	Side A: SPE / Side B: SPE	Side A: SPE / Side B: SPE	Side A: SPE / Side B: SPE
21. Bore Type	Full Bore	Full Bore	Full Bore	Full Bore
22. Body Construction	split body, bolted	split body, bolted	split body, bolted	split body, bolted
23. Cladding or Coating	N/A	N/A	N/A	N/A
24. Valve Testing	FAT according A.9.3	FAT according A.9.3	FAT according A.9.3	FAT according A.9.3
25. Notes	N/A	N/A	N/A	N/A

Valve Code	VES-1503-2-C207	VES-1503-2-C210	VES-1503-3-C107	VES-1503-3-C207
Specs	F6	F6	F10 G10P	F6
1. Valve Type	Ball	Ball	Ball	Ball
2. Sealing Type	Metal to Metal	Metal to Metal	Metal to Metal	Metal to Metal
3. Valve Specification Level (VSL)	VSL-2	VSL-2	VSL-3	VSL-3
4. Ball Mouting	Trunnion	Trunnion	Trunnion	Trunnion
5. Standard	ASME B16.34 LTD	ASME B16.34 LTD	ASME B16.34 LTD	ASME B16.34 LTD
6. Size Range (NPS)	½" - 1 ½"	½" - 1 ½"	½" - 1 ½"	½" - 1 ½"
7. End Connection	socket weld ends ASME B16.11 with nipple SCH 160	socket weld ends ASME B16.11 with nipple SCH 160	socket weld ends ASME B16.11 with nipple SCH 160	socket weld ends ASME B16.11 with nipple SCH 160
8. Pressure Class	1500	1500	1500	1500
9. Temperature	-46°C to 200°C	-46°C to 340°C	0°C to 210°C	-46°C to 200°C
10. Material Class	Carbon Steel	Carbon Steel	Carbon Steel	Carbon Steel
11. Body Material	ASTM A350 Gr LF2 CL1	ASTM A350 Gr LF2 CL1	ASTM A105	ASTM A350 Gr LF2 CL1
12. Obturator Material	AISI 316 + Hard Coating (acc. Item A.7.1.7.4)	AISI 316 + Hard Coating (acc. Item A.7.1.7.4)	AISI 410 + Hard Coating (acc. Item A.7.1.7.4)	AISI 316 + Hard Coating (acc. Item A.7.1.7.4)
13. Seat Material	AISI 316 + Hard Coating (acc. Item A.7.1.7.4)	AISI 316 + Hard Coating (acc. Item A.7.1.7.4)	AISI 410 + Hard Coating (acc. Item A.7.1.7.4)	AISI 316 + Hard Coating (acc. Item A.7.1.7.4)
14. Seat Insert	N/A	N/A	N/A	N/A
15. Spring (Seat) Material	UNS N07750	UNS N07750	UNS N07750	UNS N07750
16. Stem Material	ASTM A276 (UNS S31803)	ASTM A276 (UNS S31803)	ASTM A276 (UNS S41000)	ASTM A276 (UNS S31803)
17. Seat-Stem Seal	Group E (acc. item A.7.1.5.6)	Group F (acc. item A.7.1.5.6)	Group D (acc. item A.7.1.5.6)	Group E (acc. item A.7.1.5.6)
18. Operator Type	Lever	Lever	Lever	Lever
19. Additional Requirement	Fire Tested (acc. item A.6.1.4)	Fire Tested (acc. item A.6.1.4)	Fire Tested (acc. item A.6.1.4)	Fire Tested (acc. item A.6.1.4)
20. Seat Type	Side A: SPE / Side B: SPE	Side A: SPE / Side B: SPE	Side A: SPE / Side B: SPE	Side A: SPE / Side B: SPE
21. Bore Type	Full Bore	Full Bore	Full Bore	Full Bore
22. Body Construction	split body, bolted	split body, bolted	split body, bolted	split body, bolted
23. Cladding or Coating	N/A	N/A	N/A	N/A
24. Valve Testing	FAT according A.9.3	FAT according A.9.3	FAT according A.9.3	FAT according A.9.3
25. Notes	N/A	N/A	N/A	N/A

Valve Code	VES-1503-3-C210	VES-150-3-C116	VES-150-3-C117	VES-150-3-C126
Specs	F6	B9 B10	B9 B10	B9 B10
1. Valve Type	Ball	Ball	Ball	Ball
2. Sealing Type	Metal to Metal	Soft	Soft	Soft
3. Valve Specification Level (VSL)	VSL-3	VSL-3	VSL-3	VSL-3
4. Ball Mouting	Trunnion	N/A	N/A	N/A
5. Standard	ASME B16.34 LTD	API 6D / IOGP S-562	API 6D / IOGP S-562	API 6D / IOGP S-562
6. Size Range (NPS)	½" - 1 ½"	2" - 36"	2" - 36"	2" - 36"
7. End Connection	socket weld ends ASME B16.11 with nipple SCH 160	N/A	N/A	N/A
8. Pressure Class	1500	150	150	150
9. Temperature	-46°C to 340°C	-29°C to 150°C	-29°C to 150°C	0°C to 150°C
10. Material Class	Carbon Steel	Carbon Steel	Carbon Steel	Carbon Steel
11. Body Material	ASTM A350 Gr LF2 CL1	ASTM A105	ASTM A105	ASTM A105
12. Obturator Material	AISI 316 + Hard Coating (acc. Item A.7.1.7.4)	AISI 410	AISI 410	AISI 410
13. Seat Material	AISI 316 + Hard Coating (acc. Item A.7.1.7.4)	AISI 410	AISI 410	AISI 410
14. Seat Insert	N/A	PTFE reinforced with 25% Carbon	PTFE reinforced with 25% Carbon	PTFE reinforced with 25% Carbon
15. Spring (Seat) Material	UNS N07750	UNS N07750	UNS N07750	UNS N07750
16. Stem Material	ASTM A276 (UNS S31803)	ASTM A276 (UNS S41000)	ASTM A276 (UNS S41000)	ASTM A276 (UNS S41000)
17. Seat-Stem Seal	Group F (acc. item A.7.1.5.6)	Group B (acc. item A.7.1.5.6)	Group B (acc. item A.7.1.5.6)	Group C (acc. item A.7.1.5.6)
18. Operator Type	Lever	N/A	N/A	N/A
19. Additional Requirement	Fire Tested (acc. item A.6.1.4)	N/A	Fire Tested (acc. item A.6.1.4)	N/A
20. Seat Type	Side A: SPE / Side B: SPE	Side A: SPE / Side B: DPE; DIB-2 & DBB	Side A: SPE / Side B: DPE; DIB-2 & DBB	Side A: SPE / Side B: DPE; DIB-2 & DBB
21. Bore Type	Full Bore	Full Bore	Full Bore	Full Bore
22. Body Construction	split body, bolted	split body, bolted	split body, bolted	split body, bolted
23. Cladding or Coating	N/A	Partial clad - SS316 weld overlay on all body sealing areas	Partial clad - SS316 weld overlay on all body sealing areas	Partial clad - SS316 weld overlay on all body sealing areas
24. Valve Testing	FAT according A.9.3	FAT according A.9.3	FAT according A.9.3	FAT according A.9.3
25. Notes	N/A	N/A	N/A	N/A

Valve Code	VES-150-3-C127		VES-150-3-C136		VES-150-3-C137		VES-150-3-C152	
Specs	B9 B10		B9 B10		B9 B10		B9 B10	
1. Valve Type	Ball		Ball		Ball		Ball	
2. Sealing Type	Soft		Soft		Soft		Metal to Metal	
3. Valve Specification Level (VSL)	VSL-3		VSL-3		VSL-3		VSL-3	
4. Ball Mouting	2" - 4"	Floating	2" - 4"	Floating	2" - 4"	Floating	2" - 4"	Floating
	6" - 36"	Trunnion	6" - 36"	Trunnion	6" - 36"	Trunnion	6" - 36"	Trunnion
5. Standard	API 6D / IOGP S-562		API 6D / IOGP S-562		API 6D / IOGP S-562		API 6D / IOGP S-562	
6. Size Range (NPS)	2" - 36"		2" - 36"		2" - 36"		2" - 36"	
7. End Connection	2" - 24"	ASME B16.5, RF	2" - 24"	ASME B16.5, RF	2" - 24"	ASME B16.5, RF	2" - 24"	ASME B16.5, RF
	26" - 36"	ASME B16.47 Series A, RF	26" - 36"	ASME B16.47 Series A, RF	26" - 36"	ASME B16.47 Series A, RF	26" - 36"	ASME B16.47 Series A, RF
8. Pressure Class	150		150		150		150	
9. Temperature	0°C to 150°C		0°C to 150°C		0°C to 150°C		0°C to 150°C	
10. Material Class	Carbon Steel		Carbon Steel		Carbon Steel		Carbon Steel	
11. Body Material	ASTM A105 + SS316 weld overlay (acc. item A.7.1.7.3)		ASTM A105 + SS316 weld overlay (acc. item A.7.1.7.3)		ASTM A105 + SS316 weld overlay (acc. item A.7.1.7.3)		ASTM A105 + SS316 weld overlay (acc. item A.7.1.7.3)	
12. Obturator Material	AISI 410		AISI 410		AISI 410		AISI 410 + Tungsten carbide coating	
13. Seat Material	AISI 410		AISI 410		AISI 410		AISI 410 + Tungsten carbide coating	
14. Seat Insert	PTFE reinforced with 25% Carbon		PTFE reinforced with 25% Carbon		PTFE reinforced with 25% Carbon		N/A	
15. Spring (Seat) Material	UNS N07750		UNS N07750		UNS N07750		UNS N07750	
16. Stem Material	ASTM A276 (UNS S41000)		ASTM A276 (UNS S41000)		ASTM A276 (UNS S41000)		ASTM A276 (UNS S41000)	
17. Seat-Stem Seal	Group C (acc. item A.7.1.5.6)		Group D (acc. item A.7.1.5.6)		Group D (acc. item A.7.1.5.6)		Group A (acc. item A.7.1.5.6)	
18. Operator Type	2" - 4"	Lever	2" - 4"	Lever	2" - 4"	Lever	2" - 4"	Lever
	6" - 36"	Gearbox	6" - 36"	Gearbox	6" - 36"	Gearbox	6" - 36"	Gearbox
19. Additional Requirement	Fire Tested (acc. item A.6.1.4)		N/A		Fire Tested (acc. item A.6.1.4)		N/A	
20. Seat Type	Side A: SPE / Side B: DPE; DIB-2 & DBB		Side A: SPE / Side B: DPE; DIB-2 & DBB		Side A: SPE / Side B: DPE; DIB-2 & DBB		Side A: SPE / Side B: DPE; DIB-2 & DBB	
21. Bore Type	Full Bore		Full Bore		Full Bore		Full Bore	
22. Body Construction	split body, bolted		split body, bolted		split body, bolted		split body, bolted	
23. Cladding or Coating	Partial clad - SS316 weld overlay on all body sealing areas		Partial clad - SS316 weld overlay on all body sealing areas		Partial clad - SS316 weld overlay on all body sealing areas		Partial clad - SS316 weld overlay on all body sealing areas	
24. Valve Testing	FAT according A.9.3		FAT according A.9.3		FAT according A.9.3		FAT according A.9.3	
25. Notes	N/A		N/A		N/A		Acceptance criteria for sealing tests see Annex A	

Valve Code	VES-150-3-C153		VES-150-3-C162		VES-150-3-C163		VES-150-3-C172	
Specs	B9 B10		B4 B9 B10		B4 B9 B10		B9 B10	
1. Valve Type	Ball		Ball		Ball		Ball	
2. Sealing Type	Metal to Metal		Metal to Metal		Metal to Metal		Metal to Metal	
3. Valve Specification Level (VSL)	VSL-3		VSL-3		VSL-3		VSL-3	
4. Ball Mouting	2" - 4"	Floating	2" - 4"	Floating	2" - 4"	Floating	2" - 4"	Floating
	6" - 36"	Trunnion	6" - 36"	Trunnion	6" - 36"	Trunnion	6" - 36"	Trunnion
5. Standard	API 6D / IOGP S-562		API 6D		API 6D		API 6D	
6. Size Range (NPS)	2" - 36"		2" - 36"		2" - 36"		2" - 36"	
7. End Connection	2" - 24"	ASME B16.5, RF	2" - 24"	ASME B16.5, RF	2" - 24"	ASME B16.5, RF	2" - 24"	ASME B16.5, RF
	26" - 36"	ASME B16.47 Series A, RF	26" - 36"	ASME B16.47 Series A, RF	26" - 36"	ASME B16.47 Series A, RF	26" - 36"	ASME B16.47 Series A, RF
8. Pressure Class	150		150		150		150	
9. Temperature	0°C to 150°C		0°C to 210°C		0°C to 210°C		0°C to 210°C	
10. Material Class	Carbon Steel		Carbon Steel		Carbon Steel		Carbon Steel	
11. Body Material	ASTM A105 + SS316 weld overlay (acc. item A.7.1.7.3)		ASTM A105 + SS316 weld overlay (acc. item A.7.1.7.3)		ASTM A105 + SS316 weld overlay (acc. item A.7.1.7.3)		ASTM A105 + SS316 weld overlay (acc. item A.7.1.7.3)	
12. Obturator Material	AISI 410 + Tungsten carbide coating		AISI 410 + Tungsten carbide coating		AISI 410 + Tungsten carbide coating		AISI 410 + Tungsten carbide coating	
13. Seat Material	AISI 410 + Tungsten carbide coating		AISI 410 + Tungsten carbide coating		AISI 410 + Tungsten carbide coating		AISI 410 + Tungsten carbide coating	
14. Seat Insert	N/A		N/A		N/A		N/A	
15. Spring (Seat) Material	UNS N07750		UNS N07750		UNS N07750		UNS N07750	
16. Stem Material	ASTM A276 (UNS S41000)		ASTM A276 (UNS S41000)		ASTM A276 (UNS S41000)		ASTM A276 (UNS S41000)	
17. Seat-Stem Seal	Group A (acc. item A.7.1.5.6)		Group C (acc. item A.7.1.5.6)		Group C (acc. item A.7.1.5.6)		Group D (acc. item A.7.1.5.6)	
18. Operator Type	2" - 4"	Lever	2" - 4"	Lever	2" - 4"	Lever	2" - 4"	Lever
	6" - 36"	Gearbox	6" - 36"	Gearbox	6" - 36"	Gearbox	6" - 36"	Gearbox
19. Additional Requirement	Fire Tested (acc. item A.6.1.4)		N/A		Fire Tested (acc. item A.6.1.4)		N/A	
20. Seat Type	Side A: SPE / Side B: DPE; DIB-2 & DBB		Side A: SPE / Side B: DPE; DIB-2 & DBB		Side A: SPE / Side B: DPE; DIB-2 & DBB		Side A: SPE / Side B: DPE; DIB-2 & DBB	
21. Bore Type	Full Bore		Full Bore		Full Bore		Full Bore	
22. Body Construction	split body, bolted		split body, bolted		split body, bolted		split body, bolted	
23. Cladding or Coating	Partial clad - SS316 weld overlay on all body sealing areas		Partial clad - SS316 weld overlay on all body sealing areas		Partial clad - SS316 weld overlay on all body sealing areas		Partial clad - SS316 weld overlay on all body sealing areas	
24. Valve Testing	FAT according A.9.3		FAT according A.9.3		FAT according A.9.3		FAT according A.9.3	
25. Notes	Acceptance criteria for sealing tests see Annex A		Acceptance criteria for sealing tests see Annex A		Acceptance criteria for sealing tests see Annex A		Acceptance criteria for sealing tests see Annex A	

Valve Code	VES-150-3-C173		VES-150-3-C182		VES-150-3-C183		VES-150-3-C216	
Specs	B9 B10		B9 B10		B9 B10		B6 B19	
1. Valve Type	Ball		Ball		Ball		Ball	
2. Sealing Type	Metal to Metal		Metal to Metal		Metal to Metal		Soft	
3. Valve Specification Level (VSL)	VSL-3		VSL-3		VSL-3		VSL-3	
4. Ball Mouting	2" - 4"	Floating	2" - 4"	Floating	2" - 4"	Floating	2" - 4"	Floating
	6" - 36"	Trunnion	6" - 36"	Trunnion	6" - 36"	Trunnion	6" - 36"	Trunnion
5. Standard	API 6D		API 6D		API 6D		API 6D / IOGP S-562	
6. Size Range (NPS)	2" - 36"		2" - 36"		2" - 36"		2" - 36"	
7. End Connection	2" - 24"	ASME B16.5, RF	2" - 24"	ASME B16.5, RF	2" - 24"	ASME B16.5, RF	2" - 24"	ASME B16.5, RF
	26" - 36"	ASME B16.47 Series A, RF	26" - 36"	ASME B16.47 Series A, RF	26" - 36"	ASME B16.47 Series A, RF	26" - 36"	ASME B16.47 Series A, RF
8. Pressure Class	150		150		150		150	
9. Temperature	0°C to 210°C		0°C to 400°C		0°C to 400°C		-30°C to 150°C	
10. Material Class	Carbon Steel		Carbon Steel		Carbon Steel		Carbon Steel	
11. Body Material	ASTM A105 + SS316 weld overlay (acc. item A.7.1.7.3)		ASTM A105 + SS316 weld overlay (acc. item A.7.1.7.3)		ASTM A105 + SS316 weld overlay (acc. item A.7.1.7.3)		ASTM A350 Gr LF2 CL1 + Inconel 625 weld overlay (acc. item A.7.1.7.3)	
12. Obturator Material	AISI 410 + Tungsten carbide coating		AISI 410 + Chrome-Nickel Spray and Fuse (acc. Item A.8.2.2.4)		AISI 410 + Chrome-Nickel Spray and Fuse (acc. Item A.8.2.2.4)		AISI 316	
13. Seat Material	AISI 410 + Tungsten carbide coating		AISI 410 + Chrome-Nickel Spray and Fuse (acc. Item A.8.2.2.4)		AISI 410 + Chrome-Nickel Spray and Fuse (acc. Item A.8.2.2.4)		AISI 316	
14. Seat Insert	N/A		N/A		N/A		PTFE reinforced with 25% Carbon	
15. Spring (Seat) Material	UNS N07750		UNS N07750		UNS N07750		UNS N07750	
16. Stem Material	ASTM A276 (UNS S41000)		ASTM A276 (UNS S41000)		ASTM A276 (UNS S41000)		ASTM A276 (UNS S31600)	
17. Seat-Stem Seal	Group D (acc. item A.7.1.5.6)		Group F (acc. item A.7.1.5.6)		Group F (acc. item A.7.1.5.6)		Group B (acc. item A.7.1.5.6)	
18. Operator Type	2" - 4"	Lever	2" - 4"	Lever	2" - 4"	Lever	2" - 4"	Lever
	6" - 36"	Gearbox	6" - 36"	Gearbox	6" - 36"	Gearbox	6" - 36"	Gearbox
19. Additional Requirement	Fire Tested (acc. item A.6.1.4)		N/A		Fire Tested (acc. item A.6.1.4)		N/A	
20. Seat Type	Side A: SPE / Side B: DPE; DIB-2 & DBB		Side A: SPE / Side B: DPE; DIB-2 & DBB		Side A: SPE / Side B: DPE; DIB-2 & DBB		Side A: SPE / Side B: DPE; DIB-2 & DBB	
21. Bore Type	Full Bore		Full Bore		Full Bore		Full Bore	
22. Body Construction	split body, bolted		split body, bolted		split body, bolted		split body, bolted	
23. Cladding or Coating	Partial clad - SS316 weld overlay on all body sealing areas		Partial clad - SS316 weld overlay on all body sealing areas		Partial clad - SS316 weld overlay on all body sealing areas		Partial clad - Inconel 625 weld overlay on all body sealing areas	
24. Valve Testing	FAT according A.9.3		FAT according A.9.3		FAT according A.9.3		FAT according A.9.3	
25. Notes	Acceptance criteria for sealing tests see Annex A		Acceptance criteria for sealing tests see Annex A		Acceptance criteria for sealing tests see Annex A		N/A	

Valve Code	VES-150-3-C217		VES-150-3-C236		VES-150-3-C237		VES-150-3-C252	
Specs	B6 B19		B6 B19		B6 B19		B6 B19	
1. Valve Type	Ball		Ball		Ball		Ball	
2. Sealing Type	Soft		Soft		Soft		Metal to Metal	
3. Valve Specification Level (VSL)	VSL-3		VSL-3		VSL-3		VSL-3	
4. Ball Mouting	2" - 4"	Floating	2" - 4"	Floating	2" - 4"	Floating	2" - 4"	Floating
	6" - 36"	Trunnion	6" - 36"	Trunnion	6" - 36"	Trunnion	6" - 36"	Trunnion
5. Standard	API 6D / IOGP S-562		API 6D / IOGP S-562		API 6D / IOGP S-562		API 6D / IOGP S-562	
6. Size Range (NPS)	2" - 36"		2" - 36"		2" - 36"		2" - 36"	
7. End Connection	2" - 24"	ASME B16.5, RF	2" - 24"	ASME B16.5, RF	2" - 24"	ASME B16.5, RF	2" - 24"	ASME B16.5, RF
	26" - 36"	ASME B16.47 Series A, RF	26" - 36"	ASME B16.47 Series A, RF	26" - 36"	ASME B16.47 Series A, RF	26" - 36"	ASME B16.47 Series A, RF
8. Pressure Class	150		150		150		150	
9. Temperature	-30°C to 150°C		-46°C to 150°C		-46°C to 150°C		-30°C to 150°C	
10. Material Class	Carbon Steel		Carbon Steel		Carbon Steel		Carbon Steel	
11. Body Material	ASTM A350 Gr LF2 CL1 + Inconel 625 weld overlay (acc. item A.7.1.7.3)		ASTM A350 Gr LF2 CL1 + Inconel 625 weld overlay (acc. item A.7.1.7.3)		ASTM A350 Gr LF2 CL1 + Inconel 625 weld overlay (acc. item A.7.1.7.3)		ASTM A350 Gr LF2 CL1 + Inconel 625 weld overlay (acc. item A.7.1.7.3)	
12. Obturator Material	AISI 316		AISI 316		AISI 316		AISI 316 + Tungsten carbide coating	
13. Seat Material	AISI 316		AISI 316		AISI 316		AISI 316 + Tungsten carbide coating	
14. Seat Insert	PTFE reinforced with 25% Carbon		PTFE reinforced with 25% Carbon		PTFE reinforced with 25% Carbon		N/A	
15. Spring (Seat) Material	UNS N07750		UNS N07750		UNS N07750		UNS N07750	
16. Stem Material	ASTM A276 (UNS S31600)		ASTM A276 (UNS S31600)		ASTM A276 (UNS S31600)		ASTM A276 (UNS S31600)	
17. Seat-Stem Seal	Group B (acc. item A.7.1.5.6)		Group E (acc. item A.7.1.5.6)		Group E (acc. item A.7.1.5.6)		Group B (acc. item A.7.1.5.6)	
18. Operator Type	2" - 4"	Lever	2" - 4"	Lever	2" - 4"	Lever	2" - 4"	Lever
	6" - 36"	Gearbox	6" - 36"	Gearbox	6" - 36"	Gearbox	6" - 36"	Gearbox
19. Additional Requirement	Fire Tested (acc. item A.6.1.4)		N/A		Fire Tested (acc. item A.6.1.4)		N/A	
20. Seat Type	Side A: SPE / Side B: DPE; DIB-2 & DBB		Side A: SPE / Side B: DPE; DIB-2 & DBB		Side A: SPE / Side B: DPE; DIB-2 & DBB		Side A: SPE / Side B: DPE; DIB-2 & DBB	
21. Bore Type	Full Bore		Full Bore		Full Bore		Full Bore	
22. Body Construction	split body, bolted		split body, bolted		split body, bolted		split body, bolted	
23. Cladding or Coating	Partial clad - Inconel 625 weld overlay on all body sealing areas		Partial clad - Inconel 625 weld overlay on all body sealing areas		Partial clad - Inconel 625 weld overlay on all body sealing areas		Partial clad - Inconel 625 weld overlay on all body sealing areas	
24. Valve Testing	FAT according A.9.3		FAT according A.9.3		FAT according A.9.3		FAT according A.9.3	
25. Notes	N/A		N/A		N/A		Acceptance criteria for sealing tests see Annex A	

Valve Code	VES-150-3-C253		VES-150-3-C272		VES-150-3-C273		VES-150-3-C282	
Specs	B6 B19		B6 B19		B6 B19		B6 B19	
1. Valve Type	Ball		Ball		Ball		Ball	
2. Sealing Type	Metal to Metal		Metal to Metal		Metal to Metal		Metal to Metal	
3. Valve Specification Level (VSL)	VSL-3		VSL-3		VSL-3		VSL-3	
4. Ball Mouting	2" - 4"	Floating	2" - 4"	Floating	2" - 4"	Floating	2" - 4"	Floating
	6" - 36"	Trunnion	6" - 36"	Trunnion	6" - 36"	Trunnion	6" - 36"	Trunnion
5. Standard	API 6D / IOGP S-562		API 6D		API 6D		API 6D	
6. Size Range (NPS)	2" - 36"		2" - 36"		2" - 36"		2" - 36"	
7. End Connection	2" - 24"	ASME B16.5, RF	2" - 24"	ASME B16.5, RF	2" - 24"	ASME B16.5, RF	2" - 24"	ASME B16.5, RF
	26" - 36"	ASME B16.47 Series A, RF	26" - 36"	ASME B16.47 Series A, RF	26" - 36"	ASME B16.47 Series A, RF	26" - 36"	ASME B16.47 Series A, RF
8. Pressure Class	150		150		150		150	
9. Temperature	-30°C to 150°C		-100°C to 200°C		-100°C to 200°C		-100°C to 345°C	
10. Material Class	Carbon Steel		Carbon Steel		Carbon Steel		Carbon Steel	
11. Body Material	ASTM A350 Gr LF2 CL1 + Inconel 625 weld overlay (acc. item A.7.1.7.3)		ASTM A350 Gr LF2 CL1 + Inconel 625 weld overlay (acc. item A.7.1.7.3)		ASTM A350 Gr LF2 CL1 + Inconel 625 weld overlay (acc. item A.7.1.7.3)		ASTM A350 Gr LF2 CL1 + Inconel 625 weld overlay (acc. item A.7.1.7.3)	
12. Obturator Material	AISI 316 + Tungsten carbide coating		AISI 316 + Tungsten carbide coating		AISI 316 + Tungsten carbide coating		AISI 316 + Chrome-Nickel Spray and Fuse (acc. Item A.8.2.2.4)	
13. Seat Material	AISI 316 + Tungsten carbide coating		AISI 316 + Tungsten carbide coating		AISI 316 + Tungsten carbide coating		AISI 316 + Chrome-Nickel Spray and Fuse (acc. Item A.8.2.2.4)	
14. Seat Insert	N/A		N/A		N/A		N/A	
15. Spring (Seat) Material	UNS N07750		UNS N07750		UNS N07750		UNS N07750	
16. Stem Material	ASTM A276 (UNS S31600)		ASTM A276 (UNS S31600)		ASTM A276 (UNS S31600)		ASTM A276 (UNS S31600)	
17. Seat-Stem Seal	Group B (acc. item A.7.1.5.6)		Group E (acc. item A.7.1.5.6)		Group E (acc. item A.7.1.5.6)		Group F (acc. item A.7.1.5.6)	
18. Operator Type	2" - 4"	Lever	2" - 4"	Lever	2" - 4"	Lever	2" - 4"	Lever
	6" - 36"	Gearbox	6" - 36"	Gearbox	6" - 36"	Gearbox	6" - 36"	Gearbox
19. Additional Requirement	Fire Tested (acc. item A.6.1.4)		N/A		Fire Tested (acc. item A.6.1.4)		N/A	
20. Seat Type	Side A: SPE / Side B: DPE; DIB-2 & DBB		Side A: SPE / Side B: DPE; DIB-2 & DBB		Side A: SPE / Side B: DPE; DIB-2 & DBB		Side A: SPE / Side B: DPE; DIB-2 & DBB	
21. Bore Type	Full Bore		Full Bore		Full Bore		Full Bore	
22. Body Construction	split body, bolted		split body, bolted		split body, bolted		split body, bolted	
23. Cladding or Coating	Partial clad - Inconel 625 weld overlay on all body sealing areas		Partial clad - Inconel 625 weld overlay on all body sealing areas		Partial clad - Inconel 625 weld overlay on all body sealing areas		Partial clad - Inconel 625 weld overlay on all body sealing areas	
24. Valve Testing	FAT according A.9.3		FAT according A.9.3		FAT according A.9.3		FAT according A.9.3	
25. Notes	Acceptance criteria for sealing tests see Annex A		Acceptance criteria for sealing tests see Annex A		Acceptance criteria for sealing tests see Annex A		Acceptance criteria for sealing tests see Annex A	

Valve Code	VES-150-3-C283		VES-150-3-C526		VES-150-3-C527		VES-150-3-C536	
Specs	B6 B19		B30		B30		B30	
1. Valve Type	Ball		Ball		Ball		Ball	
2. Sealing Type	Metal to Metal		Soft		Soft		Soft	
3. Valve Specification Level (VSL)	VSL-3		VSL-3		VSL-3		VSL-3	
4. Ball Mouting	2" - 4"	Floating	2" - 4"	Floating	2" - 4"	Floating	2" - 4"	Floating
	6" - 36"	Trunnion	6" - 30"	Trunnion	6" - 30"	Trunnion	6" - 30"	Trunnion
5. Standard	API 6D		API 6D / IOGP S-562		API 6D / IOGP S-562		API 6D / IOGP S-562	
6. Size Range (NPS)	2" - 36"		2" - 30"		2" - 30"		2" - 30"	
7. End Connection	2" - 24"	ASME B16.5, RF	2" - 24"	ASME B16.5, RF	2" - 24"	ASME B16.5, RF	2" - 24"	ASME B16.5, RF
	26" - 36"	ASME B16.47 Series A, RF	26" - 30"	ASME B16.47 Series A, RF	26" - 30"	ASME B16.47 Series A, RF	26" - 30"	ASME B16.47 Series A, RF
8. Pressure Class	150		150		150		150	
9. Temperature	-100°C to 345°C		0°C to 150°C		0°C to 150°C		0°C to 150°C	
10. Material Class	Carbon Steel		Carbon Steel		Carbon Steel		Carbon Steel	
11. Body Material	ASTM A350 Gr LF2 CL1 + Inconel 625 weld overlay (acc. item A.7.1.7.3)		ASTM A105 + Inconel 625 weld overlay (acc. item A.7.1.7.3)		ASTM A105 + Inconel 625 weld overlay (acc. item A.7.1.7.3)		ASTM A105 + Inconel 625 weld overlay (acc. item A.7.1.7.3)	
12. Obturator Material	AISI 316 + Chrome-Nickel Spray and Fuse (acc. Item A.8.2.2.4)		ASTM A105 + Inconel 625 weld overlay (acc. item A.7.1.7.3)		ASTM A105 + Inconel 625 weld overlay (acc. item A.7.1.7.3)		ASTM A105 + Inconel 625 weld overlay (acc. item A.7.1.7.3)	
13. Seat Material	AISI 316 + Chrome-Nickel Spray and Fuse (acc. Item A.8.2.2.4)		ASTM A105 + Inconel 625 weld overlay (acc. item A.7.1.7.3)		ASTM A105 + Inconel 625 weld overlay (acc. item A.7.1.7.3)		ASTM A105 + Inconel 625 weld overlay (acc. item A.7.1.7.3)	
14. Seat Insert	N/A		PTFE reinforced with 25% Carbon		PTFE reinforced with 25% Carbon		PTFE reinforced with 25% Carbon	
15. Spring (Seat) Material	UNS N07750		UNS N07750		UNS N07750		UNS N07750	
16. Stem Material	ASTM A276 (UNS S31600)		ASTM B637 (UNS N07718)		ASTM B637 (UNS N07718)		ASTM B637 (UNS N07718)	
17. Seat-Stem Seal	Group F (acc. item A.7.1.5.6)		Group C (acc. item A.7.1.5.6)		Group C (acc. item A.7.1.5.6)		Group D (acc. item A.7.1.5.6)	
18. Operator Type	2" - 4"	Lever	2" - 4"	Lever	2" - 4"	Lever	2" - 4"	Lever
	6" - 36"	Gearbox	6" - 30"	Gearbox	6" - 30"	Gearbox	6" - 30"	Gearbox
19. Additional Requirement	Fire Tested (acc. item A.6.1.4)		N/A		Fire Tested (acc. item A.6.1.4)		N/A	
20. Seat Type	Side A: SPE / Side B: DPE; DIB-2 & DBB		Side A: SPE / Side B: DPE; DIB-2 & DBB		Side A: SPE / Side B: DPE; DIB-2 & DBB		Side A: SPE / Side B: DPE; DIB-2 & DBB	
21. Bore Type	Full Bore		Full Bore		Full Bore		Full Bore	
22. Body Construction	split body, bolted		split body, bolted		split body, bolted		split body, bolted	
23. Cladding or Coating	Partial clad - Inconel 625 weld overlay on all body sealing areas		Full clad - Inconel 625 weld overlay on all wetted parts		Full clad - Inconel 625 weld overlay on all wetted parts		Full clad - Inconel 625 weld overlay on all wetted parts	
24. Valve Testing	FAT according A.9.3		FAT according A.9.3		FAT according A.9.3		FAT according A.9.3	
25. Notes	Acceptance criteria for sealing tests see Annex A		N/A		N/A		N/A	

Valve Code	VES-150-3-C537		VES-150-3-C553		VES-150-3-C562		VES-150-3-C563	
Specs	B30		B30		B30		B30	
1. Valve Type	Ball		Ball		Ball		Ball	
2. Sealing Type	Soft		Metal to Metal		Metal to Metal		Metal to Metal	
3. Valve Specification Level (VSL)	VSL-3		VSL-3		VSL-3		VSL-3	
4. Ball Mouting	2" - 4"	Floating	2" - 4"	Floating	2" - 4"	Floating	2" - 4"	Floating
	6" - 30"	Trunnion	6" - 30"	Trunnion	6" - 30"	Trunnion	6" - 30"	Trunnion
5. Standard	API 6D / IOGP S-562		API 6D / IOGP S-562		API 6D		API 6D	
6. Size Range (NPS)	2" - 30"		2" - 30"		2" - 30"		2" - 30"	
7. End Connection	2" - 24"	ASME B16.5, RF	2" - 24"	ASME B16.5, RF	2" - 24"	ASME B16.5, RF	2" - 24"	ASME B16.5, RF
	26" - 30"	ASME B16.47 Series A, RF	26" - 30"	ASME B16.47 Series A, RF	26" - 30"	ASME B16.47 Series A, RF	26" - 30"	ASME B16.47 Series A, RF
8. Pressure Class	150		150		150		150	
9. Temperature	0°C to 150°C		-29°C to 150°C		0°C to 210°C		0°C to 210°C	
10. Material Class	Carbon Steel		Carbon Steel		Carbon Steel		Carbon Steel	
11. Body Material	ASTM A105 + Inconel 625 weld overlay (acc. item A.7.1.7.3)		ASTM A105 + Inconel 625 weld overlay (acc. item A.7.1.7.3)		ASTM A105 + Inconel 625 weld overlay (acc. item A.7.1.7.3)		ASTM A105 + Inconel 625 weld overlay (acc. item A.7.1.7.3)	
12. Obturator Material	ASTM A105 + Inconel 625 weld overlay (acc. item A.7.1.7.3)		ASTM A105 + Inconel 625 weld overlay (acc. item A.7.1.7.3) + Tungsten carbide coating		ASTM A105 + Inconel 625 weld overlay (acc. item A.7.1.7.3) + Tungsten carbide coating		ASTM A105 + Inconel 625 weld overlay (acc. item A.7.1.7.3) + Tungsten carbide coating	
13. Seat Material	ASTM A105 + Inconel 625 weld overlay (acc. item A.7.1.7.3)		ASTM A105 + Inconel 625 weld overlay (acc. item A.7.1.7.3) + Tungsten carbide coating		ASTM A105 + Inconel 625 weld overlay (acc. item A.7.1.7.3) + Tungsten carbide coating		ASTM A105 + Inconel 625 weld overlay (acc. item A.7.1.7.3) + Tungsten carbide coating	
14. Seat Insert	PTFE reinforced with 25% Carbon		N/A		N/A		N/A	
15. Spring (Seat) Material	UNS N07750		UNS N07750		UNS N07750		UNS N07750	
16. Stem Material	ASTM B637 (UNS N07718)		ASTM B637 (UNS N07718)		ASTM B637 (UNS N07718)		ASTM B637 (UNS N07718)	
17. Seat-Stem Seal	Group D (acc. item A.7.1.5.6)		Group B (acc. item A.7.1.5.6)		Group C (acc. item A.7.1.5.6)		Group C (acc. item A.7.1.5.6)	
18. Operator Type	2" - 4"	Lever	2" - 4"	Lever	2" - 4"	Lever	2" - 4"	Lever
	6" - 30"	Gearbox	6" - 30"	Gearbox	6" - 30"	Gearbox	6" - 30"	Gearbox
19. Additional Requirement	Fire Tested (acc. item A.6.1.4)		Fire Tested (acc. item A.6.1.4)		N/A		Fire Tested (acc. item A.6.1.4)	
20. Seat Type	Side A: SPE / Side B: DPE; DIB-2 & DBB		Side A: SPE / Side B: DPE; DIB-2 & DBB		Side A: SPE / Side B: DPE; DIB-2 & DBB		Side A: SPE / Side B: DPE; DIB-2 & DBB	
21. Bore Type	Full Bore		Full Bore		Full Bore		Full Bore	
22. Body Construction	split body, bolted		split body, bolted		split body, bolted		split body, bolted	
23. Cladding or Coating	Full clad - Inconel 625 weld overlay on all wetted parts		Full clad - Inconel 625 weld overlay on all wetted parts		Full clad - Inconel 625 weld overlay on all wetted parts		Full clad - Inconel 625 weld overlay on all wetted parts	
24. Valve Testing	FAT according A.9.3		FAT according A.9.3		FAT according A.9.3		FAT according A.9.3	
25. Notes	N/A		Acceptance criteria for sealing tests see Annex A		Acceptance criteria for sealing tests see Annex A		Acceptance criteria for sealing tests see Annex A	

Valve Code	VES-150-3-C572		VES-150-3-C573		VES-150-3-C582		VES-150-3-D216	
Specs	B30		B30		B30		B16 B26	
1. Valve Type	Ball		Ball		Ball		Ball	
2. Sealing Type	Metal to Metal		Metal to Metal		Metal to Metal		Soft	
3. Valve Specification Level (VSL)	VSL-3		VSL-3		VSL-3		VSL-3	
4. Ball Mouting	2" - 4"	Floating	2" - 4"	Floating	2" - 4"	Floating	2" - 4"	Floating
	6" - 30"	Trunnion	6" - 30"	Trunnion	6" - 30"	Trunnion	6" - 32"	Trunnion
5. Standard	API 6D		API 6D		API 6D		API 6D / IOGP S-562	
6. Size Range (NPS)	2" - 30"		2" - 30"		2" - 30"		2" - 32"	
7. End Connection	2" - 24"	ASME B16.5, RF	2" - 24"	ASME B16.5, RF	2" - 24"	ASME B16.5, RF	2" - 24"	ASME B16.5, RF
	26" - 30"	ASME B16.47 Series A, RF	26" - 30"	ASME B16.47 Series A, RF	26" - 30"	ASME B16.47 Series A, RF	26" - 32"	ASME B16.47 Series A, RF
8. Pressure Class	150		150		150		150	
9. Temperature	0°C to 210°C		0°C to 210°C		-29°C to 340°C		-30°C to 150°C	
10. Material Class	Carbon Steel		Carbon Steel		Carbon Steel		Duplex Steel	
11. Body Material	ASTM A105 + Inconel 625 weld overlay (acc. item A.7.1.7.3)		ASTM A105 + Inconel 625 weld overlay (acc. item A.7.1.7.3)		ASTM A105 or ASTM A216 Gr WCB + Inconel 625 weld overlay (acc. item A.7.1.7.3)		ASTM A182 Gr F51	
12. Obturator Material	ASTM A105 + Inconel 625 weld overlay (acc. item A.7.1.7.3) + Tungsten carbide coating		ASTM A105 + Inconel 625 weld overlay (acc. item A.7.1.7.3) + Tungsten carbide coating		ASTM A105 + Inconel 625 weld overlay (acc. item A.7.1.7.3) + Chrome-Nickel Spray and Fuse (acc. Item A.8.2.2.4)		Duplex (UNS S31803)	
13. Seat Material	ASTM A105 + Inconel 625 weld overlay (acc. item A.7.1.7.3) + Tungsten carbide coating		ASTM A105 + Inconel 625 weld overlay (acc. item A.7.1.7.3) + Tungsten carbide coating		ASTM A105 + Inconel 625 weld overlay (acc. item A.7.1.7.3) + Chrome-Nickel Spray and Fuse (acc. Item A.8.2.2.4)		Duplex (UNS S31803)	
14. Seat Insert	N/A		N/A		N/A		PTFE reinforced with 25% Carbon	
15. Spring (Seat) Material	UNS N07750		UNS N07750		UNS N07750		UNS N07750	
16. Stem Material	ASTM B637 (UNS N07718)		ASTM B637 (UNS N07718)		ASTM B637 (UNS N07718)		ASTM A276 (UNS S31803)	
17. Seat-Stem Seal	Group D (acc. item A.7.1.5.6)		Group D (acc. item A.7.1.5.6)		Group F (acc. item A.7.1.5.6)		Group B (acc. item A.7.1.5.6)	
18. Operator Type	2" - 4"	Lever	2" - 4"	Lever	2" - 4"	Lever	2" - 4"	Lever
	6" - 30"	Gearbox	6" - 30"	Gearbox	6" - 30"	Gearbox	6" - 32"	Gearbox
19. Additional Requirement	N/A		Fire Tested (acc. item A.6.1.4)		N/A		N/A	
20. Seat Type	Side A: SPE / Side B: DPE; DIB-2 & DBB		Side A: SPE / Side B: DPE; DIB-2 & DBB		Side A: SPE / Side B: DPE; DIB-2 & DBB		Side A: SPE / Side B: DPE; DIB-2 & DBB	
21. Bore Type	Full Bore		Full Bore		Full Bore		Full Bore	
22. Body Construction	split body, bolted		split body, bolted		split body, bolted		split body, bolted	
23. Cladding or Coating	Full clad - Inconel 625 weld overlay on all wetted parts		Full clad - Inconel 625 weld overlay on all wetted parts		Full clad - Inconel 625 weld overlay on all wetted parts		N/A	
24. Valve Testing	FAT according A.9.3		FAT according A.9.3		FAT according A.9.3		FAT according A.9.3	
25. Notes	Acceptance criteria for sealing tests see Annex A		Acceptance criteria for sealing tests see Annex A		N/A		N/A	

Valve Code	VES-150-3-D217		VES-150-3-D226		VES-150-3-D227		VES-150-3-D236	
Specs	B11 B16		B11 B16 B26		B16		B16	
1. Valve Type	Ball		Ball		Ball		Ball	
2. Sealing Type	Soft		Soft		Soft		Soft	
3. Valve Specification Level (VSL)	VSL-3		VSL-3		VSL-3		VSL-3	
4. Ball Mouting	2" - 4"	Floating	2" - 4"	Floating	2" - 4"	Floating	2" - 4"	Floating
	6" - 32"	Trunnion	6" - 32"	Trunnion	6" - 32"	Trunnion	6" - 32"	Trunnion
5. Standard	API 6D / IOGP S-562		API 6D / IOGP S-562		API 6D / IOGP S-562		API 6D / IOGP S-562	
6. Size Range (NPS)	2" - 32"		2" - 32"		2" - 32"		2" - 32"	
7. End Connection	2" - 24"	ASME B16.5, RF	2" - 24"	ASME B16.5, RF	2" - 24"	ASME B16.5, RF	2" - 24"	ASME B16.5, RF
	26" - 32"	ASME B16.47 Series A, RF	26" - 32"	ASME B16.47 Series A, RF	26" - 32"	ASME B16.47 Series A, RF	26" - 32"	ASME B16.47 Series A, RF
8. Pressure Class	150		150		150		150	
9. Temperature	-30°C to 150°C		0°C to 150°C		0°C to 150°C		-46°C to 150°C	
10. Material Class	Duplex Steel		Duplex Steel		Duplex Steel		Duplex Steel	
11. Body Material	ASTM A182 Gr F51		ASTM A182 Gr F51		ASTM A182 Gr F51		ASTM A182 Gr F51	
12. Obturator Material	Duplex (UNS S31803)		Duplex (UNS S31803)		Duplex (UNS S31803)		Duplex (UNS S31803)	
13. Seat Material	Duplex (UNS S31803)		Duplex (UNS S31803)		Duplex (UNS S31803)		Duplex (UNS S31803)	
14. Seat Insert	PTFE reinforced with 25% Carbon		PTFE reinforced with 25% Carbon		PTFE reinforced with 25% Carbon		PTFE reinforced with 25% Carbon	
15. Spring (Seat) Material	UNS N07750		UNS N07750		UNS N07750		UNS N07750	
16. Stem Material	ASTM A276 (UNS S31803)		ASTM A276 (UNS S31803)		ASTM A276 (UNS S31803)		ASTM A276 (UNS S31803)	
17. Seat-Stem Seal	Group B (acc. item A.7.1.5.6)		Group C (acc. item A.7.1.5.6)		Group C (acc. item A.7.1.5.6)		Group E (acc. item A.7.1.5.6)	
18. Operator Type	2" - 4"	Lever	2" - 4"	Lever	2" - 4"	Lever	2" - 4"	Lever
	6" - 32"	Gearbox	6" - 32"	Gearbox	6" - 32"	Gearbox	6" - 32"	Gearbox
19. Additional Requirement	Fire Tested (acc. item A.6.1.4)		N/A		Fire Tested (acc. item A.6.1.4)		N/A	
20. Seat Type	Side A: SPE / Side B: DPE; DIB-2 & DBB		Side A: SPE / Side B: DPE; DIB-2 & DBB		Side A: SPE / Side B: DPE; DIB-2 & DBB		Side A: SPE / Side B: DPE; DIB-2 & DBB	
21. Bore Type	Full Bore		Full Bore		Full Bore		Full Bore	
22. Body Construction	split body, bolted		split body, bolted		split body, bolted		split body, bolted	
23. Cladding or Coating	N/A		N/A		N/A		N/A	
24. Valve Testing	FAT according A.9.3		FAT according A.9.3		FAT according A.9.3		FAT according A.9.3	
25. Notes	N/A		N/A		N/A		N/A	

Valve Code	VES-150-3-D237		VES-150-3-D252		VES-150-3-D253		VES-150-3-D262	
Specs	B16		B16		B16		B16	
1. Valve Type	Ball		Ball		Ball		Ball	
2. Sealing Type	Soft		Metal to Metal		Metal to Metal		Metal to Metal	
3. Valve Specification Level (VSL)	VSL-3		VSL-3		VSL-3		VSL-3	
4. Ball Mouting	2" - 4"	Floating	2" - 4"	Floating	2" - 4"	Floating	2" - 4"	Floating
	6" - 32"	Trunnion	6" - 32"	Trunnion	6" - 32"	Trunnion	6" - 32"	Trunnion
5. Standard	API 6D / IOGP S-562		API 6D / IOGP S-562		API 6D / IOGP S-562		API 6D / IOGP S-562	
6. Size Range (NPS)	2" - 32"		2" - 32"		2" - 32"		2" - 32"	
7. End Connection	2" - 24"	ASME B16.5, RF	2" - 24"	ASME B16.5, RF	2" - 24"	ASME B16.5, RF	2" - 24"	ASME B16.5, RF
	26" - 32"	ASME B16.47 Series A, RF	26" - 32"	ASME B16.47 Series A, RF	26" - 32"	ASME B16.47 Series A, RF	26" - 32"	ASME B16.47 Series A, RF
8. Pressure Class	150		150		150		150	
9. Temperature	-46°C to 150°C		-30°C to 150°C		-30°C to 150°C		0°C to 150°C	
10. Material Class	Duplex Steel		Duplex Steel		Duplex Steel		Duplex Steel	
11. Body Material	ASTM A182 Gr F51		ASTM A182 Gr F51		ASTM A182 Gr F51		ASTM A182 Gr F51	
12. Obturator Material	Duplex (UNS S31803)		Duplex (UNS S31803) + Tungsten carbide coating		Duplex (UNS S31803) + Tungsten carbide coating		Duplex (UNS S31803) + Tungsten carbide coating	
13. Seat Material	Duplex (UNS S31803)		Duplex (UNS S31803) + Tungsten carbide coating		Duplex (UNS S31803) + Tungsten carbide coating		Duplex (UNS S31803) + Tungsten carbide coating	
14. Seat Insert	PTFE reinforced with 25% Carbon		N/A		N/A		N/A	
15. Spring (Seat) Material	UNS N07750		UNS N07750		UNS N07750		UNS N07750	
16. Stem Material	ASTM A276 (UNS S31803)		ASTM A276 (UNS S31803)		ASTM A276 (UNS S31803)		ASTM A276 (UNS S31803)	
17. Seat-Stem Seal	Group E (acc. item A.7.1.5.6)		Group B (acc. item A.7.1.5.6)		Group B (acc. item A.7.1.5.6)		Group C (acc. item A.7.1.5.6)	
18. Operator Type	2" - 4"	Lever	2" - 4"	Lever	2" - 4"	Lever	2" - 4"	Lever
	6" - 32"	Gearbox	6" - 32"	Gearbox	6" - 32"	Gearbox	6" - 32"	Gearbox
19. Additional Requirement	Fire Tested (acc. item A.6.1.4)		N/A		Fire Tested (acc. item A.6.1.4)		N/A	
20. Seat Type	Side A: SPE / Side B: DPE; DIB-2 & DBB		Side A: SPE / Side B: DPE; DIB-2 & DBB		Side A: SPE / Side B: DPE; DIB-2 & DBB		Side A: SPE / Side B: DPE; DIB-2 & DBB	
21. Bore Type	Full Bore		Full Bore		Full Bore		Full Bore	
22. Body Construction	split body, bolted		split body, bolted		split body, bolted		split body, bolted	
23. Cladding or Coating	N/A		N/A		N/A		N/A	
24. Valve Testing	FAT according A.9.3		FAT according A.9.3		FAT according A.9.3		FAT according A.9.3	
25. Notes	N/A		Acceptance criteria for sealing tests see Annex A		Acceptance criteria for sealing tests see Annex A		Acceptance criteria for sealing tests see Annex A	

Valve Code	VES-150-3-D263		VES-150-3-D272		VES-150-3-D273		VES-150-3-D317	
Specs	B16		B16		B16		B12	
1. Valve Type	Ball		Ball		Ball		Ball	
2. Sealing Type	Metal to Metal		Metal to Metal		Metal to Metal		Soft	
3. Valve Specification Level (VSL)	VSL-3		VSL-3		VSL-3		VSL-3	
4. Ball Mouting	2" - 4"	Floating	2" - 4"	Floating	2" - 4"	Floating	2" - 4"	Floating
	6" - 32"	Trunnion	6" - 32"	Trunnion	6" - 32"	Trunnion	6" - 36"	Trunnion
5. Standard	API 6D / IOGP S-562		API 6D / IOGP S-562		API 6D / IOGP S-562		API 6D / IOGP S-562	
6. Size Range (NPS)	2" - 32"		2" - 32"		2" - 32"		2" - 36"	
7. End Connection	2" - 24"	ASME B16.5, RF	2" - 24"	ASME B16.5, RF	2" - 24"	ASME B16.5, RF	2" - 24"	ASME B16.5, RF
	26" - 32"	ASME B16.47 Series A, RF	26" - 32"	ASME B16.47 Series A, RF	26" - 32"	ASME B16.47 Series A, RF	26" - 36"	ASME B16.47 Series A, RF
8. Pressure Class	150		150		150		150	
9. Temperature	0°C to 150°C		-46°C to 150°C		-46°C to 150°C		-30°C to 150°C	
10. Material Class	Duplex Steel		Duplex Steel		Duplex Steel		Duplex Steel	
11. Body Material	ASTM A182 Gr F51		ASTM A182 Gr F51		ASTM A182 Gr F51		ASTM A182 Gr F55	
12. Obturator Material	Duplex (UNS S31803) + Tungsten carbide coating		Duplex (UNS S31803) + Tungsten carbide coating		Duplex (UNS S31803) + Tungsten carbide coating		Super Duplex (UNS S32760)	
13. Seat Material	Duplex (UNS S31803) + Tungsten carbide coating		Duplex (UNS S31803) + Tungsten carbide coating		Duplex (UNS S31803) + Tungsten carbide coating		Super Duplex (UNS S32760)	
14. Seat Insert	N/A		N/A		N/A		PTFE reinforced with 25% Carbon	
15. Spring (Seat) Material	UNS N07750		UNS N07750		UNS N07750		UNS N07750	
16. Stem Material	ASTM A276 (UNS S31803)		ASTM A276 (UNS S31803)		ASTM A276 (UNS S31803)		ASTM A276 (UNS S32760)	
17. Seat-Stem Seal	Group C (acc. item A.7.1.5.6)		Group E (acc. item A.7.1.5.6)		Group E (acc. item A.7.1.5.6)		Group B (acc. item A.7.1.5.6)	
18. Operator Type	2" - 4"	Lever	2" - 4"	Lever	2" - 4"	Lever	2" - 4"	Lever
	6" - 32"	Gearbox	6" - 32"	Gearbox	6" - 32"	Gearbox	6" - 36"	Gearbox
19. Additional Requirement	Fire Tested (acc. item A.6.1.4)		N/A		Fire Tested (acc. item A.6.1.4)		Fire Tested (acc. item A.6.1.4)	
20. Seat Type	Side A: SPE / Side B: DPE; DIB-2 & DBB		Side A: SPE / Side B: DPE; DIB-2 & DBB		Side A: SPE / Side B: DPE; DIB-2 & DBB		Side A: SPE / Side B: DPE; DIB-2 & DBB	
21. Bore Type	Full Bore		Full Bore		Full Bore		Full Bore	
22. Body Construction	split body, bolted		split body, bolted		split body, bolted		split body, bolted	
23. Cladding or Coating	N/A		N/A		N/A		N/A	
24. Valve Testing	FAT according A.9.3		FAT according A.9.3		FAT according A.9.3		FAT according A.9.3	
25. Notes	Acceptance criteria for sealing tests see Annex A		Acceptance criteria for sealing tests see Annex A		Acceptance criteria for sealing tests see Annex A		N/A	

Valve Code	VES-150-3-D337		VES-150-3-D352		VES-150-3-D353		VES-150-3-D372	
Specs	B12		B12		B12		B12	
1. Valve Type	Ball		Ball		Ball		Ball	
2. Sealing Type	Soft		Metal to Metal		Metal to Metal		Metal to Metal	
3. Valve Specification Level (VSL)	VSL-3		VSL-3		VSL-3		VSL-3	
4. Ball Mouting	2" - 4"	Floating	2" - 4"	Floating	2" - 4"	Floating	2" - 4"	Floating
	6" - 36"	Trunnion	6" - 36"	Trunnion	6" - 36"	Trunnion	6" - 36"	Trunnion
5. Standard	API 6D / IOGP S-562		API 6D / IOGP S-562		API 6D / IOGP S-562		API 6D / IOGP S-562	
6. Size Range (NPS)	2" - 36"		2" - 36"		2" - 36"		2" - 36"	
7. End Connection	2" - 24"	ASME B16.5, RF	2" - 24"	ASME B16.5, RF	2" - 24"	ASME B16.5, RF	2" - 24"	ASME B16.5, RF
	26" - 36"	ASME B16.47 Series A, RF	26" - 36"	ASME B16.47 Series A, RF	26" - 36"	ASME B16.47 Series A, RF	26" - 36"	ASME B16.47 Series A, RF
8. Pressure Class	150		150		150		150	
9. Temperature	0°C to 150°C		0°C to 150°C		0°C to 150°C		0°C to 150°C	
10. Material Class	Duplex Steel		Duplex Steel		Duplex Steel		Duplex Steel	
11. Body Material	ASTM A182 Gr F55		ASTM A182 Gr F55		ASTM A182 Gr F55		ASTM A182 Gr F55	
12. Obturator Material	Super Duplex (UNS S32760)		Super Duplex (UNS S32760) + Tungsten carbide coating		Super Duplex (UNS S32760) + Tungsten carbide coating		Super Duplex (UNS S32760) + Tungsten carbide coating	
13. Seat Material	Super Duplex (UNS S32760)		Super Duplex (UNS S32760) + Tungsten carbide coating		Super Duplex (UNS S32760) + Tungsten carbide coating		Super Duplex (UNS S32760) + Tungsten carbide coating	
14. Seat Insert	PTFE reinforced with 25% Carbon		N/A		N/A		N/A	
15. Spring (Seat) Material	UNS N07750		UNS N07750		UNS N07750		UNS N07750	
16. Stem Material	ASTM A276 (UNS S32760)		ASTM A276 (UNS S32760)		ASTM A276 (UNS S32760)		ASTM A276 (UNS S32760)	
17. Seat-Stem Seal	Group D (acc. item A.7.1.5.6)		Group A (acc. item A.7.1.5.6)		Group A (acc. item A.7.1.5.6)		Group D (acc. item A.7.1.5.6)	
18. Operator Type	2" - 4"	Lever	2" - 4"	Lever	2" - 4"	Lever	2" - 4"	Lever
	6" - 36"	Gearbox	6" - 36"	Gearbox	6" - 36"	Gearbox	6" - 36"	Gearbox
19. Additional Requirement	Fire Tested (acc. item A.6.1.4)		N/A		Fire Tested (acc. item A.6.1.4)		N/A	
20. Seat Type	Side A: SPE / Side B: DPE; DIB-2 & DBB		Side A: SPE / Side B: DPE; DIB-2 & DBB		Side A: SPE / Side B: DPE; DIB-2 & DBB		Side A: SPE / Side B: DPE; DIB-2 & DBB	
21. Bore Type	Full Bore		Full Bore		Full Bore		Full Bore	
22. Body Construction	split body, bolted		split body, bolted		split body, bolted		split body, bolted	
23. Cladding or Coating	N/A		N/A		N/A		N/A	
24. Valve Testing	FAT according A.9.3		FAT according A.9.3		FAT according A.9.3		FAT according A.9.3	
25. Notes	N/A		Acceptance criteria for sealing tests see Annex A, DBB tests to be performed at both conditions, fully opened and closed, Vent and drain connections according Annex A		Acceptance criteria for sealing tests see Annex A, DBB tests to be performed at both conditions, fully opened and closed, Vent and drain connections according Annex A		Acceptance criteria for sealing tests see Annex A, DBB tests to be performed at both conditions, fully opened and closed, Vent and drain connections according Annex A	

Valve Code	VES-150-3-D373		VES-150-3-S216		VES-150-3-S217		VES-150-3-S226	
Specs	B12		B3		B3		B3	
1. Valve Type	Ball		Ball		Ball		Ball	
2. Sealing Type	Metal to Metal		Soft		Soft		Soft	
3. Valve Specification Level (VSL)	VSL-3		VSL-3		VSL-3		VSL-3	
4. Ball Mouting	2" - 4"	Floating	2" - 4"	Floating	2" - 4"	Floating	2" - 4"	Floating
	6" - 36"	Trunnion	6" - 36"	Trunnion	6" - 36"	Trunnion	6" - 36"	Trunnion
5. Standard	API 6D / IOGP S-562		API 6D / IOGP S-562		API 6D / IOGP S-562		API 6D / IOGP S-562	
6. Size Range (NPS)	2" - 36"		2" - 36"		2" - 36"		2" - 36"	
7. End Connection	2" - 24"	ASME B16.5, RF	2" - 24"	ASME B16.5, RF	2" - 24"	ASME B16.5, RF	2" - 24"	ASME B16.5, RF
	26" - 36"	ASME B16.47 Series A, RF	26" - 36"	ASME B16.47 Series A, RF	26" - 36"	ASME B16.47 Series A, RF	26" - 36"	ASME B16.47 Series A, RF
8. Pressure Class	150		150		150		150	
9. Temperature	0°C to 150°C		-30°C to 150°C		-30°C to 150°C		0°C to 150°C	
10. Material Class	Duplex Steel		Stainless Steel		Stainless Steel		Stainless Steel	
11. Body Material	ASTM A182 Gr F55		ASTM A182 Gr F316		ASTM A182 Gr F316		ASTM A182 Gr F316	
12. Obturator Material	Super Duplex (UNS S32760) + Tungsten carbide coating		AISI 316		AISI 316		AISI 316	
13. Seat Material	Super Duplex (UNS S32760) + Tungsten carbide coating		AISI 316		AISI 316		AISI 316	
14. Seat Insert	N/A		PTFE reinforced with 25% Carbon		PTFE reinforced with 25% Carbon		PTFE reinforced with 25% Carbon	
15. Spring (Seat) Material	UNS N07750		UNS N07750		UNS N07750		UNS N07750	
16. Stem Material	ASTM A276 (UNS S32760)		ASTM A276 (UNS S31600)		ASTM A276 (UNS S31600)		ASTM A276 (UNS S31600)	
17. Seat-Stem Seal	Group D (acc. item A.7.1.5.6)		Group B (acc. item A.7.1.5.6)		Group B (acc. item A.7.1.5.6)		Group C (acc. item A.7.1.5.6)	
18. Operator Type	2" - 4"	Lever	2" - 4"	Lever	2" - 4"	Lever	2" - 4"	Lever
	6" - 36"	Gearbox	6" - 36"	Gearbox	6" - 36"	Gearbox	6" - 36"	Gearbox
19. Additional Requirement	Fire Tested (acc. item A.6.1.4)		N/A		Fire Tested (acc. item A.6.1.4)		N/A	
20. Seat Type	Side A: SPE / Side B: DPE; DIB-2 & DBB		Side A: SPE / Side B: DPE; DIB-2 & DBB		Side A: SPE / Side B: DPE; DIB-2 & DBB		Side A: SPE / Side B: DPE; DIB-2 & DBB	
21. Bore Type	Full Bore		Full Bore		Full Bore		Full Bore	
22. Body Construction	split body, bolted		split body, bolted		split body, bolted		split body, bolted	
23. Cladding or Coating	N/A		N/A		N/A		N/A	
24. Valve Testing	FAT according A.9.3		FAT according A.9.3		FAT according A.9.3		FAT according A.9.3	
25. Notes	Acceptance criteria for sealing tests see Annex A, DBB tests to be performed at both conditions, fully opened and closed, Vent and drain connections according Annex A		N/A		N/A		N/A	

Valve Code	VES-150-3-S227		VES-150-3-S236		VES-150-3-S237		VES-150-3-S252	
Specs	B3		B3		B3		B3	
1. Valve Type	Ball		Ball		Ball		Ball	
2. Sealing Type	Soft		Soft		Soft		Metal to Metal	
3. Valve Specification Level (VSL)	VSL-3		VSL-3		VSL-3		VSL-3	
4. Ball Mouting	2" - 4"	Floating	2" - 4"	Floating	2" - 4"	Floating	2" - 4"	Floating
	6" - 36"	Trunnion	6" - 36"	Trunnion	6" - 36"	Trunnion	6" - 36"	Trunnion
5. Standard	API 6D / IOGP S-562		API 6D / IOGP S-562		API 6D / IOGP S-562		API 6D / IOGP S-562	
6. Size Range (NPS)	2" - 36"		2" - 36"		2" - 36"		2" - 36"	
7. End Connection	2" - 24"	ASME B16.5, RF	2" - 24"	ASME B16.5, RF	2" - 24"	ASME B16.5, RF	2" - 24"	ASME B16.5, RF
	26" - 36"	ASME B16.47 Series A, RF	26" - 36"	ASME B16.47 Series A, RF	26" - 36"	ASME B16.47 Series A, RF	26" - 36"	ASME B16.47 Series A, RF
8. Pressure Class	150		150		150		150	
9. Temperature	0°C to 150°C		-46°C to 150°C		-46°C to 150°C		-30°C to 150°C	
10. Material Class	Stainless Steel		Stainless Steel		Stainless Steel		Stainless Steel	
11. Body Material	ASTM A182 Gr F316		ASTM A182 Gr F316		ASTM A182 Gr F316		ASTM A182 Gr F316	
12. Obturator Material	AISI 316		AISI 316		AISI 316		AISI 316 + Tungsten carbide coating	
13. Seat Material	AISI 316		AISI 316		AISI 316		AISI 316 + Tungsten carbide coating	
14. Seat Insert	PTFE reinforced with 25% Carbon		PTFE reinforced with 25% Carbon		PTFE reinforced with 25% Carbon		N/A	
15. Spring (Seat) Material	UNS N07750		UNS N07750		UNS N07750		UNS N07750	
16. Stem Material	ASTM A276 (UNS S31600)		ASTM A276 (UNS S31600)		ASTM A276 (UNS S31600)		ASTM A276 (UNS S31600)	
17. Seat-Stem Seal	Group C (acc. item A.7.1.5.6)		Group E (acc. item A.7.1.5.6)		Group E (acc. item A.7.1.5.6)		Group B (acc. item A.7.1.5.6)	
18. Operator Type	2" - 4"	Lever	2" - 4"	Lever	2" - 4"	Lever	2" - 4"	Lever
	6" - 36"	Gearbox	6" - 36"	Gearbox	6" - 36"	Gearbox	6" - 36"	Gearbox
19. Additional Requirement	Fire Tested (acc. item A.6.1.4)		N/A		Fire Tested (acc. item A.6.1.4)		N/A	
20. Seat Type	Side A: SPE / Side B: DPE; DIB-2 & DBB		Side A: SPE / Side B: DPE; DIB-2 & DBB		Side A: SPE / Side B: DPE; DIB-2 & DBB		Side A: SPE / Side B: DPE; DIB-2 & DBB	
21. Bore Type	Full Bore		Full Bore		Full Bore		Full Bore	
22. Body Construction	split body, bolted		split body, bolted		split body, bolted		split body, bolted	
23. Cladding or Coating	N/A		N/A		N/A		N/A	
24. Valve Testing	FAT according A.9.3		FAT according A.9.3		FAT according A.9.3		FAT according A.9.3	
25. Notes	N/A		N/A		N/A		Acceptance criteria for sealing tests see Annex A	

Valve Code	VES-150-3-S253		VES-150-3-S262		VES-150-3-S263		VES-150-3-S272	
Specs	B3		B3		B3		B3	
1. Valve Type	Ball		Ball		Ball		Ball	
2. Sealing Type	Metal to Metal		Metal to Metal		Metal to Metal		Metal to Metal	
3. Valve Specification Level (VSL)	VSL-3		VSL-3		VSL-3		VSL-3	
4. Ball Mouting	2" - 4"	Floating	2" - 4"	Floating	2" - 4"	Floating	2" - 4"	Floating
	6" - 36"	Trunnion	6" - 36"	Trunnion	6" - 36"	Trunnion	6" - 36"	Trunnion
5. Standard	API 6D / IOGP S-562		API 6D		API 6D		API 6D	
6. Size Range (NPS)	2" - 36"		2" - 36"		2" - 36"		2" - 36"	
7. End Connection	2" - 24"	ASME B16.5, RF	2" - 24"	ASME B16.5, RF	2" - 24"	ASME B16.5, RF	2" - 24"	ASME B16.5, RF
	26" - 36"	ASME B16.47 Series A, RF	26" - 36"	ASME B16.47 Series A, RF	26" - 36"	ASME B16.47 Series A, RF	26" - 36"	ASME B16.47 Series A, RF
8. Pressure Class	150		150		150		150	
9. Temperature	-30°C to 150°C		0°C to 210°C		0°C to 210°C		-100°C to 200°C	
10. Material Class	Stainless Steel		Stainless Steel		Stainless Steel		Stainless Steel	
11. Body Material	ASTM A182 Gr F316		ASTM A182 Gr F316		ASTM A182 Gr F316		ASTM A182 Gr F316	
12. Obturator Material	AISI 316 + Tungsten carbide coating		AISI 316 + Tungsten carbide coating		AISI 316 + Tungsten carbide coating		AISI 316 + Tungsten carbide coating	
13. Seat Material	AISI 316 + Tungsten carbide coating		AISI 316 + Tungsten carbide coating		AISI 316 + Tungsten carbide coating		AISI 316 + Tungsten carbide coating	
14. Seat Insert	N/A		N/A		N/A		N/A	
15. Spring (Seat) Material	UNS N07750		UNS N07750		UNS N07750		UNS N07750	
16. Stem Material	ASTM A276 (UNS S31600)		ASTM A276 (UNS S31600)		ASTM A276 (UNS S31600)		ASTM A276 (UNS S31600)	
17. Seat-Stem Seal	Group B (acc. item A.7.1.5.6)		Group C (acc. item A.7.1.5.6)		Group C (acc. item A.7.1.5.6)		Group E (acc. item A.7.1.5.6)	
18. Operator Type	2" - 4"	Lever	2" - 4"	Lever	2" - 4"	Lever	2" - 4"	Lever
	6" - 36"	Gearbox	6" - 36"	Gearbox	6" - 36"	Gearbox	6" - 36"	Gearbox
19. Additional Requirement	Fire Tested (acc. item A.6.1.4)		N/A		Fire Tested (acc. item A.6.1.4)		N/A	
20. Seat Type	Side A: SPE / Side B: DPE; DIB-2 & DBB		Side A: SPE / Side B: DPE; DIB-2 & DBB		Side A: SPE / Side B: DPE; DIB-2 & DBB		Side A: SPE / Side B: DPE; DIB-2 & DBB	
21. Bore Type	Full Bore		Full Bore		Full Bore		Full Bore	
22. Body Construction	split body, bolted		split body, bolted		split body, bolted		split body, bolted	
23. Cladding or Coating	N/A		N/A		N/A		N/A	
24. Valve Testing	FAT according A.9.3		FAT according A.9.3		FAT according A.9.3		FAT according A.9.3	
25. Notes	Acceptance criteria for sealing tests see Annex A		Acceptance criteria for sealing tests see Annex A		Acceptance criteria for sealing tests see Annex A		Acceptance criteria for sealing tests see Annex A	

Valve Code	VES-150-3-S273		VES-150-3-S282		VES-150-3-S283		VES-150-4-C154	
Specs	B3		B3		B3		B9 B10	
1. Valve Type	Ball		Ball		Ball		Ball	
2. Sealing Type	Metal to Metal		Metal to Metal		Metal to Metal		Metal to Metal	
3. Valve Specification Level (VSL)	VSL-3		VSL-3		VSL-3		VSL-4	
4. Ball Mouting	2" - 4"	Floating	2" - 4"	Floating	2" - 4"	Floating	2" - 4"	Floating
	6" - 36"	Trunnion	6" - 36"	Trunnion	6" - 36"	Trunnion	6" - 36"	Trunnion
5. Standard	API 6D		API 6D		API 6D		API 6D / IOGP S-562	
6. Size Range (NPS)	2" - 36"		2" - 36"		2" - 36"		2" - 36"	
7. End Connection	2" - 24"	ASME B16.5, RF	2" - 24"	ASME B16.5, RF	2" - 24"	ASME B16.5, RF	2" - 24"	ASME B16.5, RF
	26" - 36"	ASME B16.47 Series A, RF	26" - 36"	ASME B16.47 Series A, RF	26" - 36"	ASME B16.47 Series A, RF	26" - 36"	ASME B16.47 Series A, RF
8. Pressure Class	150		150		150		150	
9. Temperature	-100°C to 200°C		-100°C to 400°C		-100°C to 400°C		0°C to 150°C	
10. Material Class	Stainless Steel		Stainless Steel		Stainless Steel		Carbon Steel	
11. Body Material	ASTM A182 Gr F316		ASTM A182 Gr F316		ASTM A182 Gr F316		ASTM A105 + SS316 weld overlay (acc. item A.7.1.7.3)	
12. Obturator Material	AISI 316 + Tungsten carbide coating		AISI 316 + Chrome-Nickel Spray and Fuse (acc. Item A.8.2.2.4)		AISI 316 + Chrome-Nickel Spray and Fuse (acc. Item A.8.2.2.4)		AISI 410 + Tungsten carbide coating	
13. Seat Material	AISI 316 + Tungsten carbide coating		AISI 316 + Chrome-Nickel Spray and Fuse (acc. Item A.8.2.2.4)		AISI 316 + Chrome-Nickel Spray and Fuse (acc. Item A.8.2.2.4)		AISI 410 + Tungsten carbide coating	
14. Seat Insert	N/A		N/A		N/A		N/A	
15. Spring (Seat) Material	UNS N07750		UNS N07750		UNS N07750		UNS N07750	
16. Stem Material	ASTM A276 (UNS S31600)		ASTM A276 (UNS S31600)		ASTM A276 (UNS S31600)		ASTM A276 (UNS S41000)	
17. Seat-Stem Seal	Group E (acc. item A.7.1.5.6)		Group F (acc. item A.7.1.5.6)		Group F (acc. item A.7.1.5.6)		Group A (acc. item A.7.1.5.6)	
18. Operator Type	2" - 4"	Lever	2" - 4"	Lever	2" - 4"	Lever	Actuated	
	6" - 36"	Gearbox	6" - 36"	Gearbox	6" - 36"	Gearbox	N/A	
19. Additional Requirement	Fire Tested (acc. item A.6.1.4)		N/A		Fire Tested (acc. item A.6.1.4)		Fire Tested (acc. item A.6.1.4)	
20. Seat Type	Side A: SPE / Side B: DPE; DIB-2 & DBB		Side A: SPE / Side B: DPE; DIB-2 & DBB		Side A: SPE / Side B: DPE; DIB-2 & DBB		Side A: SPE / Side B: DPE; DIB-2 & DBB (notes)	
21. Bore Type	Full Bore		Full Bore		Full Bore		Full Bore	
22. Body Construction	split body, bolted		split body, bolted		split body, bolted		split body, bolted	
23. Cladding or Coating	N/A		N/A		N/A		Partial clad - SS316 weld overlay on all body sealing areas	
24. Valve Testing	FAT according A.9.3		FAT according A.9.3		FAT according A.9.3		FAT according A.9.3	
25. Notes	Acceptance criteria for sealing tests see Annex A		Acceptance criteria for sealing tests see Annex A		Acceptance criteria for sealing tests see Annex A		Acceptance criteria for sealing tests see Annex A, DBB tests to be performed at both conditions, fully opened and closed, Vent and drain connections according Annex A	

Valve Code	VES-150-4-C164		VES-150-4-C174		VES-150-4-C184		VES-150-4-S254	
Specs	B9 B10		B9 B10		B9 B10		B3	
1. Valve Type	Ball		Ball		Ball		Ball	
2. Sealing Type	Metal to Metal		Metal to Metal		Metal to Metal		Metal to Metal	
3. Valve Specification Level (VSL)	VSL-4		VSL-4		VSL-4		VSL-4	
4. Ball Mouting	Trunnion		2" - 4"	Floating	Trunnion		Trunnion	
	N/A		6" - 36"	Trunnion	N/A		N/A	
5. Standard	API 6D		API 6D		API 6D		API 6D / IOGP S-562	
6. Size Range (NPS)	6" - 36"		2" - 36"		6" - 36"		6" - 36"	
7. End Connection	6" - 24"	ASME B16.5, RF	2" - 24"	ASME B16.5, RF	6" - 24"	ASME B16.5, RF	6" - 24"	ASME B16.5, RF
	26" - 36"	ASME B16.47 Series A, RF	26" - 36"	ASME B16.47 Series A, RF	26" - 36"	ASME B16.47 Series A, RF	26" - 36"	ASME B16.47 Series A, RF
8. Pressure Class	150		150		150		150	
9. Temperature	0°C to 210°C		0°C to 210°C		0°C to 400°C		-30°C to 150°C	
10. Material Class	Carbon Steel		Carbon Steel		Carbon Steel		Stainless Steel	
11. Body Material	ASTM A105 + SS316 weld overlay (acc. item A.7.1.7.3)		ASTM A105 + SS316 weld overlay (acc. item A.7.1.7.3)		ASTM A105 + SS316 weld overlay (acc. item A.7.1.7.3)		ASTM A182 Gr F316	
12. Obturator Material	AISI 410 + Tungsten carbide coating		AISI 410 + Tungsten carbide coating		AISI 410 + Chrome-Nickel Spray and Fuse (acc. Item A.8.2.2.4)		AISI 316 + Tungsten carbide coating	
13. Seat Material	AISI 410 + Tungsten carbide coating		AISI 410 + Tungsten carbide coating		AISI 410 + Chrome-Nickel Spray and Fuse (acc. Item A.8.2.2.4)		AISI 316 + Tungsten carbide coating	
14. Seat Insert	N/A		N/A		N/A		N/A	
15. Spring (Seat) Material	UNS N07750		UNS N07750		UNS N07750		UNS N07750	
16. Stem Material	ASTM A276 (UNS S41000)		ASTM A276 (UNS S41000)		ASTM A276 (UNS S41000)		ASTM A276 (UNS S31600)	
17. Seat-Stem Seal	Group C (acc. item A.7.1.5.6)		Group D (acc. item A.7.1.5.6)		Group F (acc. item A.7.1.5.6)		Group B (acc. item A.7.1.5.6)	
18. Operator Type	Actuated		Actuated		Actuated		Actuated	
19. Additional Requirement	Fire Tested (acc. item A.6.1.4)		Fire Tested (acc. item A.6.1.4)		Fire Tested (acc. item A.6.1.4)		Fire Tested (acc. item A.6.1.4)	
20. Seat Type	Side A: SPE / Side B: DPE; DIB-2 & DBB (notes)		Side A: SPE / Side B: DPE; DIB-2 & DBB (notes)		Side A: SPE / Side B: DPE; DIB-2 & DBB (notes)		Side A: SPE / Side B: DPE; DIB-2 & DBB (notes)	
21. Bore Type	Full Bore		Full Bore		Full Bore		Full Bore	
22. Body Construction	split body, bolted		split body, bolted		split body, bolted		split body, bolted	
23. Cladding or Coating	Partial clad - SS316 weld overlay on all body sealing areas		Partial clad - SS316 weld overlay on all body sealing areas		Partial clad - SS316 weld overlay on all body sealing areas		N/A	
24. Valve Testing	FAT according A.9.3		FAT according A.9.3		FAT according A.9.3		FAT according A.9.3	
25. Notes	Acceptance criteria for sealing tests see Annex A, DBB tests to be performed at both conditions, fully opened and closed, Vent and drain connections according Annex A		Acceptance criteria for sealing tests see Annex A, DBB tests to be performed at both conditions, fully opened and closed, Vent and drain connections according Annex A		Acceptance criteria for sealing tests see Annex A, DBB tests to be performed at both conditions, fully opened and closed, Vent and drain connections according Annex A		Acceptance criteria for sealing tests see Annex A, DBB tests to be performed at both conditions, fully opened and closed, Vent and drain connections according Annex A	

Valve Code	VES-150-4-S264		VES-150-4-S274		VES-150-4-S284		VES-2500-2-C114	
Specs	B3		B3		B3		H10	
1. Valve Type	Ball		Ball		Ball		Ball	
2. Sealing Type	Metal to Metal		Metal to Metal		Metal to Metal		Soft	
3. Valve Specification Level (VSL)	VSL-4		VSL-4		VSL-4		VSL-2	
4. Ball Mouting	Trunnion		Trunnion		Trunnion		N/A	
5. Standard	API 6D		API 6D		API 6D		API 6D / IOGP S-562	
6. Size Range (NPS)	6" - 36"		6" - 36"		6" - 36"		2" - 20"	
7. End Connection	6" - 24"	ASME B16.5, RF	6" - 24"	ASME B16.5, RF	6" - 24"	ASME B16.5, RF	2" - 12"	ASME B16.5
	26" - 36"	ASME B16.47 Series A, RF	26" - 36"	ASME B16.47 Series A, RF	26" - 36"	ASME B16.47 Series A, RF	14" - 20"	ISO 27509
8. Pressure Class	150		150		150		2500	
9. Temperature	0°C to 210°C		-100°C to 200°C		-100°C to 400°C		-29°C to 120°C	
10. Material Class	Stainless Steel		Stainless Steel		Stainless Steel		Carbon Steel	
11. Body Material	ASTM A182 Gr F316		ASTM A182 Gr F316		ASTM A182 Gr F316		ASTM A105 + SS316 weld overlay (acc. item A.7.1.7.3)	
12. Obturator Material	AISI 316 + Tungsten carbide coating		AISI 316 + Tungsten carbide coating		AISI 316 + Chrome-Nickel Spray and Fuse (acc. Item A.8.2.2.4)		AISI 410 + Hard Coating (acc. Item A.7.1.7.4)	
13. Seat Material	AISI 316 + Tungsten carbide coating		AISI 316 + Tungsten carbide coating		AISI 316 + Chrome-Nickel Spray and Fuse (acc. Item A.8.2.2.4)		AISI 410	
14. Seat Insert	N/A		N/A		N/A		PEEK	
15. Spring (Seat) Material	UNS N07750		UNS N07750		UNS N07750		UNS N07750	
16. Stem Material	ASTM A276 (UNS S31600)		ASTM A276 (UNS S31600)		ASTM A276 (UNS S31600)		ASTM A276 (UNS S41000)	
17. Seat-Stem Seal	Group C (acc. item A.7.1.5.6)		Group E (acc. item A.7.1.5.6)		Group F (acc. item A.7.1.5.6)		Group B (acc. item A.7.1.5.6)	
18. Operator Type	Actuated		Actuated		Actuated		N/A	
19. Additional Requirement	Fire Tested (acc. item A.6.1.4)		Fire Tested (acc. item A.6.1.4)		Fire Tested (acc. item A.6.1.4)		N/A	
20. Seat Type	Side A: SPE / Side B: DPE; DIB-2 & DBB (notes)		Side A: SPE / Side B: DPE; DIB-2 & DBB (notes)		Side A: SPE / Side B: DPE; DIB-2 & DBB (notes)		Side A: SPE / Side B: SPE; DBB	
21. Bore Type	Full Bore		Full Bore		Full Bore		Full Bore	
22. Body Construction	split body, bolted		split body, bolted		split body, bolted		split body, bolted	
23. Cladding or Coating	N/A		N/A		N/A		Partial clad - SS316 weld overlay on all body sealing areas	
24. Valve Testing	FAT according A.9.3		FAT according A.9.3		FAT according A.9.3		FAT according A.9.3	
25. Notes	Acceptance criteria for sealing tests see Annex A, DBB tests to be performed at both conditions, fully opened and closed, Vent and drain connections according Annex A		Acceptance criteria for sealing tests see Annex A, DBB tests to be performed at both conditions, fully opened and closed, Vent and drain connections according Annex A		Acceptance criteria for sealing tests see Annex A, DBB tests to be performed at both conditions, fully opened and closed, Vent and drain connections according Annex A		N/A	

Valve Code	VES-2500-2-C118		VES-2500-2-C134		VES-2500-2-C138		VES-2500-2-C150	
Specs	H10		H10		H10		H10	
1. Valve Type	Ball		Ball		Ball		Ball	
2. Sealing Type	Soft		Soft		Soft		Metal to Metal	
3. Valve Specification Level (VSL)	VSL-2		VSL-2		VSL-2		VSL-2	
4. Ball Mouting	Trunnion		Trunnion		Trunnion		Trunnion	
5. Standard	API 6D / IOGP S-562		API 6D / IOGP S-562		API 6D / IOGP S-562		API 6D / IOGP S-562	
6. Size Range (NPS)	2" - 20"		2" - 20"		2" - 20"		2" - 20"	
7. End Connection	2" - 12"	ASME B16.5, RTJ	2" - 12"	ASME B16.5, RTJ	2" - 12"	ASME B16.5, RTJ	2" - 12"	ASME B16.5, RTJ
	14" - 20"	ISO 27509, IX	14" - 20"	ISO 27509, IX	14" - 20"	ISO 27509, IX	14" - 20"	ISO 27509, IX
8. Pressure Class	2500		2500		2500		2500	
9. Temperature	0°C to 120°C		0°C to 120°C		0°C to 120°C		-29°C to 150°C	
10. Material Class	Carbon Steel		Carbon Steel		Carbon Steel		Carbon Steel	
11. Body Material	ASTM A105 + SS316 weld overlay (acc. item A.7.1.7.3)		ASTM A105 + SS316 weld overlay (acc. item A.7.1.7.3)		ASTM A105 + SS316 weld overlay (acc. item A.7.1.7.3)		ASTM A105 + SS316 weld overlay (acc. item A.7.1.7.3)	
12. Obturator Material	AISI 410 + Hard Coating (acc. Item A.7.1.7.4)		AISI 410 + Hard Coating (acc. Item A.7.1.7.4)		AISI 410 + Hard Coating (acc. Item A.7.1.7.4)		AISI 410 + Tungsten carbide coating	
13. Seat Material	AISI 410		AISI 410		AISI 410		AISI 410 + Tungsten carbide coating	
14. Seat Insert	PEEK		PEEK		PEEK		N/A	
15. Spring (Seat) Material	UNS N07750		UNS N07750		UNS N07750		UNS N07750	
16. Stem Material	ASTM A276 (UNS S41000)		ASTM A276 (UNS S41000)		ASTM A276 (UNS S41000)		ASTM A276 (UNS S41000)	
17. Seat-Stem Seal	Group A (acc. item A.7.1.5.6)		Group D (acc. item A.7.1.5.6)		Group D (acc. item A.7.1.5.6)		Group B (acc. item A.7.1.5.6)	
18. Operator Type	Gearbox		Gearbox		Gearbox		Gearbox	
19. Additional Requirement	N/A		N/A		N/A		N/A	
20. Seat Type	Side A: SPE / Side B: DPE; DIB-2 & DBB		Side A: SPE / Side B: SPE; DBB		Side A: SPE / Side B: DPE; DIB-2 & DBB		Side A: SPE / Side B: SPE	
21. Bore Type	Full Bore		Full Bore		Full Bore		Full Bore	
22. Body Construction	split body, bolted		split body, bolted		split body, bolted		split body, bolted	
23. Cladding or Coating	Partial clad - SS316 weld overlay on all body sealing areas		Partial clad - SS316 weld overlay on all body sealing areas		Partial clad - SS316 weld overlay on all body sealing areas		Partial clad - SS316 weld overlay on all body sealing areas	
24. Valve Testing	FAT according A.9.3		FAT according A.9.3		FAT according A.9.3		FAT according A.9.3	
25. Notes	N/A		N/A		N/A		N/A	

Valve Code	VES-2500-2-C152		VES-2500-2-C160		VES-2500-2-C162		VES-2500-2-C170	
Specs	H10		H10		H10		H10	
1. Valve Type	Ball		Ball		Ball		Ball	
2. Sealing Type	Metal to Metal		Metal to Metal		Metal to Metal		Metal to Metal	
3. Valve Specification Level (VSL)	VSL-2		VSL-2		VSL-2		VSL-2	
4. Ball Mouting	Trunnion		Trunnion		Trunnion		Trunnion	
5. Standard	API 6D / IOGP S-562		API 6D		API 6D		API 6D	
6. Size Range (NPS)	2" - 20"		2" - 20"		2" - 20"		2" - 20"	
7. End Connection	2" - 12"	ASME B16.5, RTJ	2" - 12"	ASME B16.5, RTJ	2" - 12"	ASME B16.5, RTJ	2" - 12"	ASME B16.5, RTJ
	14" - 20"	ISO 27509, IX	14" - 20"	ISO 27509, IX	14" - 20"	ISO 27509, IX	14" - 20"	ISO 27509, IX
8. Pressure Class	2500		2500		2500		2500	
9. Temperature	0°C to 150°C		0°C to 210°C		0°C to 210°C		0°C to 210°C	
10. Material Class	Carbon Steel		Carbon Steel		Carbon Steel		Carbon Steel	
11. Body Material	ASTM A105 + SS316 weld overlay (acc. item A.7.1.7.3)		ASTM A105 + SS316 weld overlay (acc. item A.7.1.7.3)		ASTM A105 + SS316 weld overlay (acc. item A.7.1.7.3)		ASTM A105 + SS316 weld overlay (acc. item A.7.1.7.3)	
12. Obturator Material	AISI 410 + Tungsten carbide coating		AISI 410 + Tungsten carbide coating		AISI 410 + Tungsten carbide coating		AISI 410 + Tungsten carbide coating	
13. Seat Material	AISI 410 + Tungsten carbide coating		AISI 410 + Tungsten carbide coating		AISI 410 + Tungsten carbide coating		AISI 410 + Tungsten carbide coating	
14. Seat Insert	N/A		N/A		N/A		N/A	
15. Spring (Seat) Material	UNS N07750		UNS N07750		UNS N07750		UNS N07750	
16. Stem Material	ASTM A276 (UNS S41000)		ASTM A276 (UNS S41000)		ASTM A276 (UNS S41000)		ASTM A276 (UNS S41000)	
17. Seat-Stem Seal	Group A (acc. item A.7.1.5.6)		Group C (acc. item A.7.1.5.6)		Group C (acc. item A.7.1.5.6)		Group D (acc. item A.7.1.5.6)	
18. Operator Type	Gearbox		Gearbox		Gearbox		Gearbox	
19. Additional Requirement	N/A		N/A		N/A		N/A	
20. Seat Type	Side A: SPE / Side B: DPE; DIB-2 & DBB		Side A: SPE / Side B: SPE		Side A: SPE / Side B: DPE; DIB-2 & DBB		Side A: SPE / Side B: SPE	
21. Bore Type	Full Bore		Full Bore		Full Bore		Full Bore	
22. Body Construction	split body, bolted		split body, bolted		split body, bolted		split body, bolted	
23. Cladding or Coating	Partial clad - SS316 weld overlay on all body sealing areas		Partial clad - SS316 weld overlay on all body sealing areas		Partial clad - SS316 weld overlay on all body sealing areas		Partial clad - SS316 weld overlay on all body sealing areas	
24. Valve Testing	FAT according A.9.3		FAT according A.9.3		FAT according A.9.3		FAT according A.9.3	
25. Notes	N/A		N/A		N/A		N/A	

Valve Code	VES-2500-2-C172		VES-2500-2-C214		VES-2500-2-C218		VES-2500-2-C234	
Specs	H10		H6		H6		H6	
1. Valve Type	Ball		Ball		Ball		Ball	
2. Sealing Type	Metal to Metal		Soft		Soft		Soft	
3. Valve Specification Level (VSL)	VSL-2		VSL-2		VSL-2		VSL-2	
4. Ball Mouting	Trunnion		Trunnion		Trunnion		Trunnion	
5. Standard	API 6D		API 6D / IOGP S-562		API 6D / IOGP S-562		API 6D / IOGP S-562	
6. Size Range (NPS)	2" - 20"		2" - 18"		2" - 18"		2" - 18"	
7. End Connection	2" - 12"	ASME B16.5, RTJ	2" - 12"	ASME B16.5, RTJ	2" - 12"	ASME B16.5, RTJ	2" - 12"	ASME B16.5, RTJ
	14" - 20"	ISO 27509, IX	14" - 18"	ISO 27509, IX	14" - 18"	ISO 27509, IX	14" - 18"	ISO 27509, IX
8. Pressure Class	2500		2500		2500		2500	
9. Temperature	0°C to 210°C		-30°C to 120°C		-30°C to 120°C		-46°C to 120°C	
10. Material Class	Carbon Steel		Carbon Steel		Carbon Steel		Carbon Steel	
11. Body Material	ASTM A105 + SS316 weld overlay (acc. item A.7.1.7.3)		ASTM A350 Gr LF2 CL1 + Inconel 625 weld overlay (acc. item A.7.1.7.3)		ASTM A350 Gr LF2 CL1 + Inconel 625 weld overlay (acc. item A.7.1.7.3)		ASTM A350 Gr LF2 CL1 + Inconel 625 weld overlay (acc. item A.7.1.7.3)	
12. Obturator Material	AISI 410 + Tungsten carbide coating		AISI 316		AISI 316		AISI 316	
13. Seat Material	AISI 410 + Tungsten carbide coating		AISI 316		AISI 316		AISI 316	
14. Seat Insert	N/A		PEEK		PEEK		PEEK	
15. Spring (Seat) Material	UNS N07750		UNS N07750		UNS N07750		UNS N07750	
16. Stem Material	ASTM A276 (UNS S41000)		ASTM A276 (UNS S31803)		ASTM A276 (UNS S31803)		ASTM A276 (UNS S31803)	
17. Seat-Stem Seal	Group D (acc. item A.7.1.5.6)		Group B (acc. item A.7.1.5.6)		Group B (acc. item A.7.1.5.6)		Group E (acc. item A.7.1.5.6)	
18. Operator Type	Gearbox		Gearbox		Gearbox		Gearbox	
19. Additional Requirement	N/A		N/A		N/A		N/A	
20. Seat Type	Side A: SPE / Side B: DPE; DIB-2 & DBB		Side A: SPE / Side B: SPE; DBB		Side A: SPE / Side B: DPE; DIB-2 & DBB		Side A: SPE / Side B: SPE; DBB	
21. Bore Type	Full Bore		Full Bore		Full Bore		Full Bore	
22. Body Construction	split body, bolted		split body, bolted		split body, bolted		split body, bolted	
23. Cladding or Coating	Partial clad - SS316 weld overlay on all body sealing areas		Partial clad - Inconel 625 weld overlay on all body sealing areas		Partial clad - Inconel 625 weld overlay on all body sealing areas		Partial clad - Inconel 625 weld overlay on all body sealing areas	
24. Valve Testing	FAT according A.9.3		FAT according A.9.3		FAT according A.9.3		FAT according A.9.3	
25. Notes	N/A		N/A		N/A		N/A	

Valve Code	VES-2500-2-C238		VES-2500-2-C250		VES-2500-2-C252		VES-2500-2-C270	
Specs	H6		H6		H6		H6	
1. Valve Type	Ball		Ball		Ball		Ball	
2. Sealing Type	Soft		Metal to Metal		Metal to Metal		Metal to Metal	
3. Valve Specification Level (VSL)	VSL-2		VSL-2		VSL-2		VSL-2	
4. Ball Mouting	Trunnion		Trunnion		Trunnion		Trunnion	
5. Standard	API 6D / IOGP S-562		API 6D / IOGP S-562		API 6D / IOGP S-562		API 6D	
6. Size Range (NPS)	2" - 18"		2" - 18"		2" - 18"		2" - 18"	
7. End Connection	2" - 12"	ASME B16.5, RTJ	2" - 12"	ASME B16.5, RTJ	2" - 12"	ASME B16.5, RTJ	2" - 12"	ASME B16.5, RTJ
	14" - 18"	ISO 27509, IX	14" - 18"	ISO 27509, IX	14" - 18"	ISO 27509, IX	14" - 18"	ISO 27509, IX
8. Pressure Class	2500		2500		2500		2500	
9. Temperature	-46°C to 120°C		-30°C to 150°C		-30°C to 150°C		-46°C to 200°C	
10. Material Class	Carbon Steel		Carbon Steel		Carbon Steel		Carbon Steel	
11. Body Material	ASTM A350 Gr LF2 CL1 + Inconel 625 weld overlay (acc. item A.7.1.7.3)		ASTM A350 Gr LF2 CL1 + Inconel 625 weld overlay (acc. item A.7.1.7.3)		ASTM A350 Gr LF2 CL1 + Inconel 625 weld overlay (acc. item A.7.1.7.3)		ASTM A350 Gr LF2 CL1 + Inconel 625 weld overlay (acc. item A.7.1.7.3)	
12. Obturator Material	AISI 316		AISI 316 + Tungsten carbide coating		AISI 316 + Tungsten carbide coating		AISI 316 + Tungsten carbide coating	
13. Seat Material	AISI 316		AISI 316 + Tungsten carbide coating		AISI 316 + Tungsten carbide coating		AISI 316 + Tungsten carbide coating	
14. Seat Insert	PEEK		N/A		N/A		N/A	
15. Spring (Seat) Material	UNS N07750		UNS N07750		UNS N07750		UNS N07750	
16. Stem Material	ASTM A276 (UNS S31803)		ASTM B637 (UNS N07718)		ASTM B637 (UNS N07718)		ASTM B637 (UNS N07718)	
17. Seat-Stem Seal	Group E (acc. item A.7.1.5.6)		Group B (acc. item A.7.1.5.6)		Group B (acc. item A.7.1.5.6)		Group E (acc. item A.7.1.5.6)	
18. Operator Type	Gearbox		Gearbox		Gearbox		Gearbox	
19. Additional Requirement	N/A		N/A		N/A		N/A	
20. Seat Type	Side A: SPE / Side B: DPE; DIB-2 & DBB		Side A: SPE / Side B: SPE		Side A: SPE / Side B: DPE; DIB-2 & DBB		Side A: SPE / Side B: SPE	
21. Bore Type	Full Bore		Full Bore		Full Bore		Full Bore	
22. Body Construction	split body, bolted		split body, bolted		split body, bolted		split body, bolted	
23. Cladding or Coating	Partial clad - Inconel 625 weld overlay on all body sealing areas		Partial clad - Inconel 625 weld overlay on all body sealing areas		Partial clad - Inconel 625 weld overlay on all body sealing areas		Partial clad - Inconel 625 weld overlay on all body sealing areas	
24. Valve Testing	FAT according A.9.3		FAT according A.9.3		FAT according A.9.3		FAT according A.9.3	
25. Notes	N/A		N/A		N/A		N/A	

Valve Code	VES-2500-2-C272		VES-2500-2-C534		VES-2500-2-C538		VES-2500-2-C570	
Specs	H6		H30P H30		H30P H30		H30P H30	
1. Valve Type	Ball		Ball		Ball		Ball	
2. Sealing Type	Metal to Metal		Soft		Soft		Metal to Metal	
3. Valve Specification Level (VSL)	VSL-2		VSL-2		VSL-2		VSL-2	
4. Ball Mouting	Trunnion		Trunnion		Trunnion		Trunnion	
5. Standard	API 6D		API 6D / IOGP S-562		API 6D / IOGP S-562		API 6D	
6. Size Range (NPS)	2" - 18"		2" - 24"		2" - 24"		2" - 24"	
7. End Connection	2" - 12"	ASME B16.5, RTJ	2" - 12"	ASME B16.5, RTJ	2" - 12"	ASME B16.5, RTJ	2" - 12"	ASME B16.5, RTJ
	14" - 18"	ISO 27509, IX	14" - 24"	ISO 27509, IX	14" - 24"	ISO 27509, IX	14" - 24"	ISO 27509, IX
8. Pressure Class	2500		2500		2500		2500	
9. Temperature	-46°C to 200°C		-29°C to 120°C		-29°C to 120°C		-29°C to 200°C	
10. Material Class	Carbon Steel		Carbon Steel		Carbon Steel		Carbon Steel	
11. Body Material	ASTM A350 Gr LF2 CL1 + Inconel 625 weld overlay (acc. item A.7.1.7.3)		ASTM A105 + Inconel 625 weld overlay (acc. item A.7.1.7.3)		ASTM A105 + Inconel 625 weld overlay (acc. item A.7.1.7.3)		ASTM A105 + Inconel 625 weld overlay (acc. item A.7.1.7.3)	
12. Obturator Material	AISI 316 + Tungsten carbide coating		ASTM A105 + Inconel 625 weld overlay (acc. item A.7.1.7.3)		ASTM A105 + Inconel 625 weld overlay (acc. item A.7.1.7.3)		ASTM A105 + Inconel 625 weld overlay (acc. item A.7.1.7.3) + Tungsten carbide coating	
13. Seat Material	AISI 316 + Tungsten carbide coating		ASTM A105 + Inconel 625 weld overlay (acc. item A.7.1.7.3)		ASTM A105 + Inconel 625 weld overlay (acc. item A.7.1.7.3)		ASTM A105 + Inconel 625 weld overlay (acc. item A.7.1.7.3) + Tungsten carbide coating	
14. Seat Insert	N/A		PEEK		PEEK		N/A	
15. Spring (Seat) Material	UNS N07750		UNS N07750		UNS N07750		UNS N07750	
16. Stem Material	ASTM B637 (UNS N07718)		ASTM B637 (UNS N07718)		ASTM B637 (UNS N07718)		ASTM B637 (UNS N07718)	
17. Seat-Stem Seal	Group E (acc. item A.7.1.5.6)		Group E (acc. item A.7.1.5.6)		Group E (acc. item A.7.1.5.6)		Group E (acc. item A.7.1.5.6)	
18. Operator Type	Gearbox		Gearbox		Gearbox		Gearbox	
19. Additional Requirement	N/A		N/A		N/A		N/A	
20. Seat Type	Side A: SPE / Side B: DPE; DIB-2 & DBB		Side A: SPE / Side B: SPE; DBB		Side A: SPE / Side B: DPE; DIB-2 & DBB		Side A: SPE / Side B: SPE	
21. Bore Type	Full Bore		Full Bore		Full Bore		Full Bore	
22. Body Construction	split body, bolted		split body, bolted		split body, bolted		split body, bolted	
23. Cladding or Coating	Partial clad - Inconel 625 weld overlay on all body sealing areas		Full clad - Inconel 625 weld overlay on all wetted parts		Full clad - Inconel 625 weld overlay on all wetted parts		Full clad - Inconel 625 weld overlay on all wetted parts	
24. Valve Testing	FAT according A.9.3		FAT according A.9.3		FAT according A.9.3		FAT according A.9.3	
25. Notes	N/A		N/A		N/A		N/A	

Valve Code	VES-2500-2-C572		VES-2500-2-D214		VES-2500-2-D218	VES-2500-2-D234
Specs	H30P H30		H16		H16	H16
1. Valve Type	Ball		Ball		Ball	Ball
2. Sealing Type	Metal to Metal		Soft		Soft	Soft
3. Valve Specification Level (VSL)	VSL-2		VSL-2		VSL-2	VSL-2
4. Ball Mouting	Trunnion		Trunnion		N/A	N/A
5. Standard	API 6D		API 6D / IOGP S-562		API 6D / IOGP S-562	API 6D / IOGP S-562
6. Size Range (NPS)	2" - 24"		2" - 16"		2" - 12"	2" - 12"
7. End Connection	2" - 12"	ASME B16.5, RTJ	2" - 12"	ASME B16.5, RTJ	ASME B16.5, RTJ	ASME B16.5, RTJ
	14" - 24"	ISO 27509, IX	14" - 16"	ISO 27509, IX	N/A	N/A
8. Pressure Class	2500		2500		2500	2500
9. Temperature	-29°C to 200°C		-30°C to 150°C		-30°C to 120°C	-46°C to 120°C
10. Material Class	Carbon Steel		Duplex Steel		Duplex Steel	Duplex Steel
11. Body Material	ASTM A105 + Inconel 625 weld overlay (acc. item A.7.1.7.3)		ASTM A182 Gr F51		ASTM A182 Gr F51	ASTM A182 Gr F51
12. Obturator Material	ASTM A105 + Inconel 625 weld overlay (acc. item A.7.1.7.3) + Tungsten carbide coating		Duplex (UNS S31803)		Duplex (UNS S31803)	Duplex (UNS S31803)
13. Seat Material	ASTM A105 + Inconel 625 weld overlay (acc. item A.7.1.7.3) + Tungsten carbide coating		Duplex (UNS S31803)		Super Duplex (UNS S32760)	Super Duplex (UNS S32760)
14. Seat Insert	N/A		PEEK		PEEK	PEEK
15. Spring (Seat) Material	UNS N07750		UNS N07750		UNS N07750	UNS N07750
16. Stem Material	ASTM B637 (UNS N07718)		ASTM A276 (UNS S31803)		ASTM A276 (UNS S31803)	ASTM A276 (UNS S31803)
17. Seat-Stem Seal	Group E (acc. item A.7.1.5.6)		Group B (acc. item A.7.1.5.6)		Group B (acc. item A.7.1.5.6)	Group E (acc. item A.7.1.5.6)
18. Operator Type	Gearbox		Gearbox		Gearbox	Gearbox
19. Additional Requirement	N/A		N/A		N/A	N/A
20. Seat Type	Side A: SPE / Side B: DPE; DIB-2 & DBB		Side A: SPE / Side B: SPE; DBB		Side A: SPE / Side B: DPE; DIB-2 & DBB	Side A: SPE / Side B: SPE; DBB
21. Bore Type	Full Bore		Full Bore		Full Bore	Full Bore
22. Body Construction	split body, bolted		split body, bolted		split body, bolted	split body, bolted
23. Cladding or Coating	Full clad - Inconel 625 weld overlay on all wetted parts		N/A		N/A	N/A
24. Valve Testing	FAT according A.9.3		FAT according A.9.3		FAT according A.9.3	FAT according A.9.3
25. Notes	N/A		N/A		N/A	N/A

Valve Code	VES-2500-2-D238	VES-2500-2-D270	VES-2500-2-D272	VES-2500-2-D314
Specs	H16	H16	H16	H12P H12
1. Valve Type	Ball	Ball	Ball	Ball
2. Sealing Type	Soft	Metal to Metal	Metal to Metal	Soft
3. Valve Specification Level (VSL)	VSL-2	VSL-2	VSL-2	VSL-2
4. Ball Mouting	N/A	N/A	N/A	Trunnion
5. Standard	API 6D / IOGP S-562	API 6D	API 6D	API 6D / IOGP S-562
6. Size Range (NPS)	2" - 12"	2" - 12"	2" - 12"	2" - 18"
7. End Connection	ASME B16.5, RTJ	ASME B16.5, RTJ	ASME B16.5, RTJ	2" - 12" ASME B16.5, RTJ
	N/A	N/A	N/A	14" - 18" ISO 27509, IX
8. Pressure Class	2500	2500	2500	2500
9. Temperature	-46°C to 120°C	-50°C to 200°C	-50°C to 200°C	-30°C to 150°C
10. Material Class	Duplex Steel	Duplex Steel	Duplex Steel	Duplex Steel
11. Body Material	ASTM A182 Gr F51	ASTM A182 Gr F51	ASTM A182 Gr F51	ASTM A182 Gr F55
12. Obturator Material	Duplex (UNS S31803)	Duplex (UNS S31803) + Tungsten carbide coating	Duplex (UNS S31803) + Tungsten carbide coating	Super Duplex (UNS S32760)
13. Seat Material	Super Duplex (UNS S32760)	Super Duplex (UNS S32760) + Tungsten carbide coating	Super Duplex (UNS S32760) + Tungsten carbide coating	Super Duplex (UNS S32760)
14. Seat Insert	PEEK	N/A	N/A	PEEK
15. Spring (Seat) Material	UNS N07750	UNS N07750	UNS N07750	UNS N07750
16. Stem Material	ASTM A276 (UNS S31803)	ASTM A276 (UNS S31803)	ASTM A276 (UNS S31803)	ASTM A276 (UNS S32760)
17. Seat-Stem Seal	Group E (acc. item A.7.1.5.6)	Group E (acc. item A.7.1.5.6)	Group E (acc. item A.7.1.5.6)	Group B (acc. item A.7.1.5.6)
18. Operator Type	Gearbox	Gearbox	Gearbox	Gearbox
19. Additional Requirement	N/A	N/A	N/A	N/A
20. Seat Type	Side A: SPE / Side B: DPE; DIB-2 & DBB	Side A: SPE / Side B: SPE	Side A: SPE / Side B: DPE; DIB-2 & DBB	Side A: SPE / Side B: SPE; DBB
21. Bore Type	Full Bore	Full Bore	Full Bore	Full Bore
22. Body Construction	split body, bolted	split body, bolted	split body, bolted	split body, bolted
23. Cladding or Coating	N/A	N/A	N/A	N/A
24. Valve Testing	FAT according A.9.3	FAT according A.9.3	FAT according A.9.3	FAT according A.9.3
25. Notes	N/A	N/A	N/A	N/A

Valve Code	VES-2500-2-D318		VES-2500-2-D334		VES-2500-2-D338		VES-2500-2-D350	
Specs	H12P H12		H12P H12		H12P H12		H12P H12	
1. Valve Type	Ball		Ball		Ball		Ball	
2. Sealing Type	Soft		Soft		Soft		Metal to Metal	
3. Valve Specification Level (VSL)	VSL-2		VSL-2		VSL-2		VSL-2	
4. Ball Mouting	Trunnion		Trunnion		Trunnion		Trunnion	
5. Standard	API 6D / IOGP S-562		API 6D / IOGP S-562		API 6D / IOGP S-562		API 6D / IOGP S-562	
6. Size Range (NPS)	2" - 18"		2" - 18"		2" - 18"		2" - 18"	
7. End Connection	2" - 12"	ASME B16.5, RTJ	2" - 12"	ASME B16.5, RTJ	2" - 12"	ASME B16.5, RTJ	2" - 12"	ASME B16.5, RTJ
	14" - 18"	ISO 27509, IX	14" - 18"	ISO 27509, IX	14" - 18"	ISO 27509, IX	14" - 18"	ISO 27509, IX
8. Pressure Class	2500		2500		2500		2500	
9. Temperature	-30°C to 120°C		-46°C to 120°C		-46°C to 120°C		-30°C to 150°C	
10. Material Class	Duplex Steel		Duplex Steel		Duplex Steel		Duplex Steel	
11. Body Material	ASTM A182 Gr F55		ASTM A182 Gr F55		ASTM A182 Gr F55		ASTM A182 Gr F55	
12. Obturator Material	Super Duplex (UNS S32760)		Super Duplex (UNS S32760)		Super Duplex (UNS S32760)		Super Duplex (UNS S32760) + Tungsten carbide coating	
13. Seat Material	Super Duplex (UNS S32760)		Super Duplex (UNS S32760)		Super Duplex (UNS S32760)		Super Duplex (UNS S32760) + Tungsten carbide coating	
14. Seat Insert	PEEK		PEEK		PEEK		N/A	
15. Spring (Seat) Material	UNS N07750		UNS N07750		UNS N07750		UNS N07750	
16. Stem Material	ASTM A276 (UNS S32760)		ASTM A276 (UNS S32760)		ASTM A276 (UNS S32760)		ASTM A276 (UNS S32760)	
17. Seat-Stem Seal	Group B (acc. item A.7.1.5.6)		Group E (acc. item A.7.1.5.6)		Group E (acc. item A.7.1.5.6)		Group B (acc. item A.7.1.5.6)	
18. Operator Type	Gearbox		Gearbox		Gearbox		Gearbox	
19. Additional Requirement	N/A		N/A		N/A		N/A	
20. Seat Type	Side A: SPE / Side B: DPE; DIB-2 & DBB		Side A: SPE / Side B: SPE; DBB		Side A: SPE / Side B: DPE; DIB-2 & DBB		Side A: SPE / Side B: SPE	
21. Bore Type	Full Bore		Full Bore		Full Bore		Full Bore	
22. Body Construction	split body, bolted		split body, bolted		split body, bolted		split body, bolted	
23. Cladding or Coating	N/A		N/A		N/A		N/A	
24. Valve Testing	FAT according A.9.3		FAT according A.9.3		FAT according A.9.3		FAT according A.9.3	
25. Notes	N/A		N/A		N/A		N/A	

Valve Code	VES-2500-2-D352		VES-2500-2-D370		VES-2500-2-D372		VES-2500-2-S214
Specs	H12P H12		H12P H12		H12P H12		H3
1. Valve Type	Ball		Ball		Ball		Ball
2. Sealing Type	Metal to Metal		Metal to Metal		Metal to Metal		Soft
3. Valve Specification Level (VSL)	VSL-2		VSL-2		VSL-2		VSL-2
4. Ball Mouting	Trunnion		Trunnion		Trunnion		Trunnion
5. Standard	API 6D / IOGP S-562		API 6D		API 6D		API 6D / IOGP S-562
6. Size Range (NPS)	2" - 18"		2" - 18"		2" - 18"		N/A
7. End Connection	2" - 12"	ASME B16.5, RTJ	2" - 12"	ASME B16.5, RTJ	2" - 12"	ASME B16.5, RTJ	N/A
	14" - 18"	ISO 27509, IX	14" - 18"	ISO 27509, IX	14" - 18"	ISO 27509, IX	N/A
8. Pressure Class	2500		2500		2500		2500
9. Temperature	-30°C to 150°C		-50°C to 200°C		-50°C to 200°C		-30°C to 120°C
10. Material Class	Duplex Steel		Duplex Steel		Duplex Steel		Stainless Steel
11. Body Material	ASTM A182 Gr F55		ASTM A182 Gr F55		ASTM A182 Gr F55		ASTM A182 Gr F316
12. Obturator Material	Super Duplex (UNS S32760) + Tungsten carbide coating		Super Duplex (UNS S32760) + Tungsten carbide coating		Super Duplex (UNS S32760) + Tungsten carbide coating		Duplex (UNS S31803)
13. Seat Material	Super Duplex (UNS S32760) + Tungsten carbide coating		Super Duplex (UNS S32760) + Tungsten carbide coating		Super Duplex (UNS S32760) + Tungsten carbide coating		Duplex (UNS S31803)
14. Seat Insert	N/A		N/A		N/A		PEEK
15. Spring (Seat) Material	UNS N07750		UNS N07750		UNS N07750		UNS N07750
16. Stem Material	ASTM A276 (UNS S32760)		ASTM A276 (UNS S32760)		ASTM A276 (UNS S32760)		ASTM A276 (UNS S31803)
17. Seat-Stem Seal	Group B (acc. item A.7.1.5.6)		Group E (acc. item A.7.1.5.6)		Group E (acc. item A.7.1.5.6)		Group B (acc. item A.7.1.5.6)
18. Operator Type	Gearbox		Gearbox		Gearbox		Gearbox
19. Additional Requirement	N/A		N/A		N/A		N/A
20. Seat Type	Side A: SPE / Side B: DPE; DIB-2 & DBB		Side A: SPE / Side B: SPE		Side A: SPE / Side B: DPE; DIB-2 & DBB		Side A: SPE / Side B: SPE; DBB
21. Bore Type	Full Bore		Full Bore		Full Bore		Full Bore
22. Body Construction	split body, bolted		split body, bolted		split body, bolted		split body, bolted
23. Cladding or Coating	N/A		N/A		N/A		N/A
24. Valve Testing	FAT according A.9.3		FAT according A.9.3		FAT according A.9.3		FAT according A.9.3
25. Notes	N/A		N/A		N/A		N/A

Valve Code	VES-2500-2-S215		VES-2500-2-S218		VES-2500-2-S219		VES-2500-2-S224	
Specs	H3		H3		H3		H3	
1. Valve Type	Ball		Ball		Ball		Ball	
2. Sealing Type	Soft		Soft		Soft		Soft	
3. Valve Specification Level (VSL)	VSL-2		VSL-2		VSL-2		VSL-2	
4. Ball Mouting	Trunnion		Trunnion		Trunnion		Trunnion	
5. Standard	API 6D / IOGP S-562		API 6D / IOGP S-562		API 6D / IOGP S-562		API 6D / IOGP S-562	
6. Size Range (NPS)	2" - 16"		2" - 16"		2" - 16"		2" - 16"	
7. End Connection	2" - 12"	ASME B16.5, RTJ	2" - 12"	ASME B16.5, RTJ	2" - 12"	ASME B16.5, RTJ	2" - 12"	ASME B16.5, RTJ
	14" - 16"	ISO 27509, IX	14" - 16"	ISO 27509, IX	14" - 16"	ISO 27509, IX	14" - 16"	ISO 27509, IX
8. Pressure Class	2500		2500		2500		2500	
9. Temperature	-30°C to 150°C		-30°C to 120°C		-30°C to 120°C		0°C to 120°C	
10. Material Class	Stainless Steel		Stainless Steel		Stainless Steel		Stainless Steel	
11. Body Material	ASTM A182 Gr F316		ASTM A182 Gr F316		ASTM A182 Gr F316		ASTM A182 Gr F316	
12. Obturator Material	Duplex (UNS S31803)		Duplex (UNS S31803)		Duplex (UNS S31803)		Duplex (UNS S31803)	
13. Seat Material	Duplex (UNS S31803)		Duplex (UNS S31803)		Duplex (UNS S31803)		Duplex (UNS S31803)	
14. Seat Insert	PEEK		PEEK		PEEK		PEEK	
15. Spring (Seat) Material	UNS N07750		UNS N07750		UNS N07750		UNS N07750	
16. Stem Material	ASTM A276 (UNS S31803)		ASTM A276 (UNS S31803)		ASTM A276 (UNS S31803)		ASTM A276 (UNS S31803)	
17. Seat-Stem Seal	Group B (acc. item A.7.1.5.6)		Group B (acc. item A.7.1.5.6)		Group B (acc. item A.7.1.5.6)		Group C (acc. item A.7.1.5.6)	
18. Operator Type	Gearbox		Gearbox		Gearbox		Gearbox	
19. Additional Requirement	Fire Tested (acc. item A.6.1.4)		N/A		Fire Tested (acc. item A.6.1.4)		N/A	
20. Seat Type	Side A: SPE / Side B: SPE; DBB		Side A: SPE / Side B: DPE; DIB-2 & DBB		Side A: SPE / Side B: DPE; DIB-2 & DBB		Side A: SPE / Side B: SPE; DBB	
21. Bore Type	Full Bore		Full Bore		Full Bore		Full Bore	
22. Body Construction	split body, bolted		split body, bolted		split body, bolted		split body, bolted	
23. Cladding or Coating	N/A		N/A		N/A		N/A	
24. Valve Testing	FAT according A.9.3		FAT according A.9.3		FAT according A.9.3		FAT according A.9.3	
25. Notes	N/A		N/A		N/A		N/A	

Valve Code	VES-2500-2-S228		VES-2500-2-S234		VES-2500-2-S238		VES-2500-2-S250	
Specs	H3		H3		H3		H3	
1. Valve Type	Ball		Ball		Ball		Ball	
2. Sealing Type	Soft		Soft		Soft		Metal to Metal	
3. Valve Specification Level (VSL)	VSL-2		VSL-2		VSL-2		VSL-2	
4. Ball Mouting	Trunnion		Trunnion		Trunnion		Trunnion	
5. Standard	API 6D / IOGP S-562		API 6D / IOGP S-562		API 6D / IOGP S-562		API 6D / IOGP S-562	
6. Size Range (NPS)	2" - 16"		2" - 16"		2" - 16"		2" - 16"	
7. End Connection	2" - 12"	ASME B16.5, RTJ	2" - 12"	ASME B16.5, RTJ	2" - 12"	ASME B16.5, RTJ	2" - 12"	ASME B16.5, RTJ
	14" - 16"	ISO 27509, IX	14" - 16"	ISO 27509, IX	14" - 16"	ISO 27509, IX	14" - 16"	ISO 27509, IX
8. Pressure Class	2500		2500		2500		2500	
9. Temperature	0°C to 120°C		-46°C to 120°C		-46°C to 120°C		-30°C to 150°C	
10. Material Class	Stainless Steel		Stainless Steel		Stainless Steel		Stainless Steel	
11. Body Material	ASTM A182 Gr F316		ASTM A182 Gr F316		ASTM A182 Gr F316		ASTM A182 Gr F316	
12. Obturator Material	Duplex (UNS S31803)		Duplex (UNS S31803)		Duplex (UNS S31803)		AISI 316 + Tungsten carbide coating	
13. Seat Material	Duplex (UNS S31803)		Duplex (UNS S31803)		Duplex (UNS S31803)		AISI 316 + Tungsten carbide coating	
14. Seat Insert	PEEK		PEEK		PEEK		N/A	
15. Spring (Seat) Material	UNS N07750		UNS N07750		UNS N07750		UNS N07750	
16. Stem Material	ASTM A276 (UNS S31803)		ASTM A276 (UNS S31803)		ASTM A276 (UNS S31803)		ASTM A276 (UNS S31803)	
17. Seat-Stem Seal	Group C (acc. item A.7.1.5.6)		Group E (acc. item A.7.1.5.6)		Group E (acc. item A.7.1.5.6)		Group B (acc. item A.7.1.5.6)	
18. Operator Type	Gearbox		Gearbox		Gearbox		Gearbox	
19. Additional Requirement	N/A		N/A		N/A		N/A	
20. Seat Type	Side A: SPE / Side B: DPE; DIB-2 & DBB		Side A: SPE / Side B: SPE; DBB		Side A: SPE / Side B: DPE; DIB-2 & DBB		Side A: SPE / Side B: SPE	
21. Bore Type	Full Bore		Full Bore		Full Bore		Full Bore	
22. Body Construction	split body, bolted		split body, bolted		split body, bolted		split body, bolted	
23. Cladding or Coating	N/A		N/A		N/A		N/A	
24. Valve Testing	FAT according A.9.3		FAT according A.9.3		FAT according A.9.3		FAT according A.9.3	
25. Notes	N/A		N/A		N/A		N/A	

Valve Code	VES-2500-2-S252		VES-2500-2-S260		VES-2500-2-S262		VES-2500-2-S270	
Specs	H3		H3		H3		H3	
1. Valve Type	Ball		Ball		Ball		Ball	
2. Sealing Type	Metal to Metal		Metal to Metal		Metal to Metal		Metal to Metal	
3. Valve Specification Level (VSL)	VSL-2		VSL-2		VSL-2		VSL-2	
4. Ball Mouting	Trunnion		Trunnion		Trunnion		Trunnion	
5. Standard	API 6D / IOGP S-562		API 6D		API 6D		API 6D	
6. Size Range (NPS)	2" - 16"		2" - 16"		2" - 16"		2" - 16"	
7. End Connection	2" - 12"	ASME B16.5, RTJ	2" - 12"	ASME B16.5, RTJ	2" - 12"	ASME B16.5, RTJ	2" - 12"	ASME B16.5, RTJ
	14" - 16"	ISO 27509, IX	14" - 16"	ISO 27509, IX	14" - 16"	ISO 27509, IX	14" - 16"	ISO 27509, IX
8. Pressure Class	2500		2500		2500		2500	
9. Temperature	-30°C to 150°C		0°C to 210°C		0°C to 210°C		-100°C to 200°C	
10. Material Class	Stainless Steel		Stainless Steel		Stainless Steel		Stainless Steel	
11. Body Material	ASTM A182 Gr F316		ASTM A182 Gr F316		ASTM A182 Gr F316		ASTM A182 Gr F316	
12. Obturator Material	AISI 316 + Tungsten carbide coating		AISI 316 + Tungsten carbide coating		AISI 316 + Tungsten carbide coating		AISI 316 + Tungsten carbide coating	
13. Seat Material	AISI 316 + Tungsten carbide coating		AISI 316 + Tungsten carbide coating		AISI 316 + Tungsten carbide coating		AISI 316 + Tungsten carbide coating	
14. Seat Insert	N/A		N/A		N/A		N/A	
15. Spring (Seat) Material	UNS N07750		UNS N07750		UNS N07750		UNS N07750	
16. Stem Material	ASTM A276 (UNS S31803)		ASTM A276 (UNS S31803)		ASTM A276 (UNS S31803)		ASTM B637 (UNS N07718)	
17. Seat-Stem Seal	Group B (acc. item A.7.1.5.6)		Group C (acc. item A.7.1.5.6)		Group C (acc. item A.7.1.5.6)		Group E (acc. item A.7.1.5.6)	
18. Operator Type	Gearbox		Gearbox		Gearbox		Gearbox	
19. Additional Requirement	N/A		N/A		N/A		N/A	
20. Seat Type	Side A: SPE / Side B: DPE; DIB-2 & DBB		Side A: SPE / Side B: SPE		Side A: SPE / Side B: DPE; DIB-2 & DBB		Side A: SPE / Side B: SPE	
21. Bore Type	Full Bore		Full Bore		Full Bore		Full Bore	
22. Body Construction	split body, bolted		split body, bolted		split body, bolted		split body, bolted	
23. Cladding or Coating	N/A		N/A		N/A		N/A	
24. Valve Testing	FAT according A.9.3		FAT according A.9.3		FAT according A.9.3		FAT according A.9.3	
25. Notes	N/A		N/A		N/A		N/A	

Valve Code	VES-2500-2-S272		VES-2500-3-C152		VES-2500-3-C153		VES-2500-3-C162	
Specs	H3		H10		H10		H10	
1. Valve Type	Ball		Ball		Ball		Ball	
2. Sealing Type	Metal to Metal		Metal to Metal		Metal to Metal		Metal to Metal	
3. Valve Specification Level (VSL)	VSL-2		VSL-3		VSL-3		VSL-3	
4. Ball Mouting	Trunnion		Trunnion		Trunnion		Trunnion	
5. Standard	API 6D		API 6D / IOGP S-562		API 6D / IOGP S-562		API 6D	
6. Size Range (NPS)	2" - 16"		2" - 20"		2" - 20"		2" - 20"	
7. End Connection	2" - 12"	ASME B16.5, RTJ	2" - 12"	ASME B16.5, RTJ	2" - 12"	ASME B16.5, RTJ	2" - 12"	ASME B16.5, RTJ
	14" - 16"	ISO 27509, IX	14" - 20"	ISO 27509, IX	14" - 20"	ISO 27509, IX	14" - 20"	ISO 27509, IX
8. Pressure Class	2500		2500		2500		2500	
9. Temperature	-100°C to 200°C		0°C to 150°C		-29°C to 150°C		0°C to 210°C	
10. Material Class	Stainless Steel		Carbon Steel		Carbon Steel		Carbon Steel	
11. Body Material	ASTM A182 Gr F316		ASTM A105 + SS316 weld overlay (acc. item A.7.1.7.3)		ASTM A105 + SS316 weld overlay (acc. item A.7.1.7.3)		ASTM A105 + SS316 weld overlay (acc. item A.7.1.7.3)	
12. Obturator Material	AISI 316 + Tungsten carbide coating		AISI 410 + Tungsten carbide coating		AISI 410 + Tungsten carbide coating		AISI 410 + Tungsten carbide coating	
13. Seat Material	AISI 316 + Tungsten carbide coating		AISI 410 + Tungsten carbide coating		AISI 410 + Tungsten carbide coating		AISI 410 + Tungsten carbide coating	
14. Seat Insert	N/A		N/A		N/A		N/A	
15. Spring (Seat) Material	UNS N07750		UNS N07750		UNS N07750		UNS N07750	
16. Stem Material	ASTM B637 (UNS N07718)		ASTM A276 (UNS S41000)		ASTM A276 (UNS S41000)		ASTM A276 (UNS S41000)	
17. Seat-Stem Seal	Group E (acc. item A.7.1.5.6)		Group A (acc. item A.7.1.5.6)		Group B (acc. item A.7.1.5.6)		Group C (acc. item A.7.1.5.6)	
18. Operator Type	Gearbox		Gearbox		Gearbox		Gearbox	
19. Additional Requirement	N/A		N/A		Fire Tested (acc. item A.6.1.4)		N/A	
20. Seat Type	Side A: SPE / Side B: DPE; DIB-2 & DBB		Side A: SPE / Side B: DPE; DIB-2 & DBB		Side A: SPE / Side B: DPE; DIB-2 & DBB		Side A: SPE / Side B: DPE; DIB-2 & DBB	
21. Bore Type	Full Bore		Full Bore		Full Bore		Full Bore	
22. Body Construction	split body, bolted		split body, bolted		split body, bolted		split body, bolted	
23. Cladding or Coating	N/A		Partial clad - SS316 weld overlay on all body sealing areas		Partial clad - SS316 weld overlay on all body sealing areas		Partial clad - SS316 weld overlay on all body sealing areas	
24. Valve Testing	FAT according A.9.3		FAT according A.9.3		FAT according A.9.3		FAT according A.9.3	
25. Notes	N/A		Acceptance criteria for sealing tests see Annex A		Acceptance criteria for sealing tests see Annex A		Acceptance criteria for sealing tests see Annex A	

Valve Code	VES-2500-3-C163		VES-2500-3-C172		VES-2500-3-C173		VES-2500-3-C252	
Specs	H10		H10		H10		H6	
1. Valve Type	Ball		Ball		Ball		Ball	
2. Sealing Type	Metal to Metal		Metal to Metal		Metal to Metal		Metal to Metal	
3. Valve Specification Level (VSL)	VSL-3		VSL-3		VSL-3		VSL-3	
4. Ball Mouting	Trunnion		Trunnion		Trunnion		Trunnion	
5. Standard	API 6D		API 6D		API 6D		API 6D / IOGP S-562	
6. Size Range (NPS)	2" - 20"		2" - 20"		2" - 20"		2" - 18"	
7. End Connection	2" - 12"	ASME B16.5, RTJ	2" - 12"	ASME B16.5, RTJ	2" - 12"	ASME B16.5, RTJ	2" - 12"	ASME B16.5, RTJ
	14" - 20"	ISO 27509, IX	14" - 20"	ISO 27509, IX	14" - 20"	ISO 27509, IX	14" - 18"	ISO 27509, IX
8. Pressure Class	2500		2500		2500		2500	
9. Temperature	0°C to 210°C		0°C to 210°C		-29°C to 200°C		-30°C to 150°C	
10. Material Class	Carbon Steel		Carbon Steel		Carbon Steel		Carbon Steel	
11. Body Material	ASTM A105 + SS316 weld overlay (acc. item A.7.1.7.3)		ASTM A105 + SS316 weld overlay (acc. item A.7.1.7.3)		ASTM A105 + SS316 weld overlay (acc. item A.7.1.7.3)		ASTM A350 Gr LF2 CL1 + Inconel 625 weld overlay (acc. item A.7.1.7.3)	
12. Obturator Material	AISI 410 + Tungsten carbide coating		AISI 410 + Tungsten carbide coating		AISI 410 + Tungsten carbide coating		AISI 316 + Tungsten carbide coating	
13. Seat Material	AISI 410 + Tungsten carbide coating		AISI 410 + Tungsten carbide coating		AISI 410 + Tungsten carbide coating		AISI 316 + Tungsten carbide coating	
14. Seat Insert	N/A		N/A		N/A		N/A	
15. Spring (Seat) Material	UNS N07750		UNS N07750		UNS N07750		UNS N07750	
16. Stem Material	ASTM A276 (UNS S41000)		ASTM A276 (UNS S41000)		ASTM A276 (UNS S41000)		ASTM B637 (UNS N07718)	
17. Seat-Stem Seal	Group C (acc. item A.7.1.5.6)		Group D (acc. item A.7.1.5.6)		Group E (acc. item A.7.1.5.6)		Group B (acc. item A.7.1.5.6)	
18. Operator Type	Gearbox		Gearbox		Gearbox		Gearbox	
19. Additional Requirement	Fire Tested (acc. item A.6.1.4)		N/A		Fire Tested (acc. item A.6.1.4)		N/A	
20. Seat Type	Side A: SPE / Side B: DPE; DIB-2 & DBB		Side A: SPE / Side B: DPE; DIB-2 & DBB		Side A: SPE / Side B: DPE; DIB-2 & DBB		Side A: SPE / Side B: DPE; DIB-2 & DBB	
21. Bore Type	Full Bore		Full Bore		Full Bore		Full Bore	
22. Body Construction	split body, bolted		split body, bolted		split body, bolted		split body, bolted	
23. Cladding or Coating	Partial clad - SS316 weld overlay on all body sealing areas		Partial clad - SS316 weld overlay on all body sealing areas		Partial clad - SS316 weld overlay on all body sealing areas		Partial clad - Inconel 625 weld overlay on all body sealing areas	
24. Valve Testing	FAT according A.9.3		FAT according A.9.3		FAT according A.9.3		FAT according A.9.3	
25. Notes	Acceptance criteria for sealing tests see Annex A		Acceptance criteria for sealing tests see Annex A		Acceptance criteria for sealing tests see Annex A		Acceptance criteria for sealing tests see Annex A	

Valve Code	VES-2500-3-C253		VES-2500-3-C272		VES-2500-3-C273		VES-2500-3-C572	
Specs	H6		H6		H6		H30P H30	
1. Valve Type	Ball		Ball		Ball		Ball	
2. Sealing Type	Metal to Metal		Metal to Metal		Metal to Metal		Metal to Metal	
3. Valve Specification Level (VSL)	VSL-3		VSL-3		VSL-3		VSL-3	
4. Ball Mouting	Trunnion		Trunnion		Trunnion		Trunnion	
5. Standard	API 6D / IOGP S-562		API 6D		API 6D		API 6D	
6. Size Range (NPS)	2" - 18"		2" - 18"		2" - 18"		2" - 24"	
7. End Connection	2" - 12"	ASME B16.5, RTJ	2" - 12"	ASME B16.5, RTJ	2" - 12"	ASME B16.5, RTJ	2" - 12"	ASME B16.5, RTJ
	14" - 18"	ISO 27509, IX	14" - 18"	ISO 27509, IX	14" - 18"	ISO 27509, IX	14" - 24"	ISO 27509, IX
8. Pressure Class	2500		2500		2500		2500	
9. Temperature	-30°C to 150°C		-46°C to 200°C		-46°C to 200°C		-29°C to 200°C	
10. Material Class	Carbon Steel		Carbon Steel		Carbon Steel		Carbon Steel	
11. Body Material	ASTM A350 Gr LF2 CL1 + Inconel 625 weld overlay (acc. item A.7.1.7.3)		ASTM A350 Gr LF2 CL1 + Inconel 625 weld overlay (acc. item A.7.1.7.3)		ASTM A350 Gr LF2 CL1 + Inconel 625 weld overlay (acc. item A.7.1.7.3)		ASTM A105 + Inconel 625 weld overlay (acc. item A.7.1.7.3)	
12. Obturator Material	AISI 316 + Tungsten carbide coating		AISI 316 + Tungsten carbide coating		AISI 316 + Tungsten carbide coating		ASTM A105 + Inconel 625 weld overlay (acc. item A.7.1.7.3) + Tungsten carbide coating	
13. Seat Material	AISI 316 + Tungsten carbide coating		AISI 316 + Tungsten carbide coating		AISI 316 + Tungsten carbide coating		ASTM A105 + Inconel 625 weld overlay (acc. item A.7.1.7.3) + Tungsten carbide coating	
14. Seat Insert	N/A		N/A		N/A		N/A	
15. Spring (Seat) Material	UNS N07750		UNS N07750		UNS N07750		UNS N07750	
16. Stem Material	ASTM B637 (UNS N07718)		ASTM B637 (UNS N07718)		ASTM B637 (UNS N07718)		ASTM B637 (UNS N07718)	
17. Seat-Stem Seal	Group B (acc. item A.7.1.5.6)		Group E (acc. item A.7.1.5.6)		Group E (acc. item A.7.1.5.6)		Group E (acc. item A.7.1.5.6)	
18. Operator Type	Gearbox		Gearbox		Gearbox		Gearbox	
19. Additional Requirement	Fire Tested (acc. item A.6.1.4)		N/A		Fire Tested (acc. item A.6.1.4)		N/A	
20. Seat Type	Side A: SPE / Side B: DPE; DIB-2 & DBB		Side A: SPE / Side B: DPE; DIB-2 & DBB		Side A: SPE / Side B: DPE; DIB-2 & DBB		Side A: SPE / Side B: DPE; DIB-2 & DBB	
21. Bore Type	Full Bore		Full Bore		Full Bore		Full Bore	
22. Body Construction	split body, bolted		split body, bolted		split body, bolted		split body, bolted	
23. Cladding or Coating	Partial clad - Inconel 625 weld overlay on all body sealing areas		Partial clad - Inconel 625 weld overlay on all body sealing areas		Partial clad - Inconel 625 weld overlay on all body sealing areas		Full clad - Inconel 625 weld overlay on all wetted parts	
24. Valve Testing	FAT according A.9.3		FAT according A.9.3		FAT according A.9.3		FAT according A.9.3	
25. Notes	Acceptance criteria for sealing tests see Annex A		Acceptance criteria for sealing tests see Annex A		Acceptance criteria for sealing tests see Annex A		Acceptance criteria for sealing tests see Annex A	

Valve Code	VES-2500-3-C573		VES-2500-3-D352		VES-2500-3-D353		VES-2500-3-D372	
Specs	H30P H30		H12P H12		H12P H12		H12P H12	
1. Valve Type	Ball		Ball		Ball		Ball	
2. Sealing Type	Metal to Metal		Metal to Metal		Metal to Metal		Metal to Metal	
3. Valve Specification Level (VSL)	VSL-3		VSL-3		VSL-3		VSL-3	
4. Ball Mouting	Trunnion		Trunnion		Trunnion		Trunnion	
5. Standard	API 6D		API 6D / IOGP S-562		API 6D / IOGP S-562		API 6D	
6. Size Range (NPS)	2" - 24"		2" - 18"		2" - 18"		2" - 18"	
7. End Connection	2" - 12"	ASME B16.5, RTJ	2" - 12"	ASME B16.5, RTJ	2" - 12"	ASME B16.5, RTJ	2" - 12"	ASME B16.5, RTJ
	14" - 24"	ISO 27509, IX	14" - 18"	ISO 27509, IX	14" - 18"	ISO 27509, IX	14" - 18"	ISO 27509, IX
8. Pressure Class	2500		2500		2500		2500	
9. Temperature	-29°C to 200°C		-30°C to 150°C		-30°C to 150°C		-50°C to 200°C	
10. Material Class	Carbon Steel		Duplex Steel		Duplex Steel		Duplex Steel	
11. Body Material	ASTM A105 + Inconel 625 weld overlay (acc. item A.7.1.7.3)		ASTM A182 Gr F55		ASTM A182 Gr F55		ASTM A182 Gr F55	
12. Obturator Material	ASTM A105 + Inconel 625 weld overlay (acc. item A.7.1.7.3) + Tungsten carbide coating		Super Duplex (UNS S32760) + Tungsten carbide coating		Super Duplex (UNS S32760) + Tungsten carbide coating		Super Duplex (UNS S32760) + Tungsten carbide coating	
13. Seat Material	ASTM A105 + Inconel 625 weld overlay (acc. item A.7.1.7.3) + Tungsten carbide coating		Super Duplex (UNS S32760) + Tungsten carbide coating		Super Duplex (UNS S32760) + Tungsten carbide coating		Super Duplex (UNS S32760) + Tungsten carbide coating	
14. Seat Insert	N/A		N/A		N/A		N/A	
15. Spring (Seat) Material	UNS N07750		UNS N07750		UNS N07750		UNS N07750	
16. Stem Material	ASTM B637 (UNS N07718)		ASTM A276 (UNS S32760)		ASTM A276 (UNS S32760)		ASTM A276 (UNS S32760)	
17. Seat-Stem Seal	Group E (acc. item A.7.1.5.6)		Group B (acc. item A.7.1.5.6)		Group B (acc. item A.7.1.5.6)		Group E (acc. item A.7.1.5.6)	
18. Operator Type	Gearbox		Gearbox		Gearbox		Gearbox	
19. Additional Requirement	Fire Tested (acc. item A.6.1.4)		N/A		Fire Tested (acc. item A.6.1.4)		N/A	
20. Seat Type	Side A: SPE / Side B: DPE; DIB-2 & DBB		Side A: SPE / Side B: DPE; DIB-2 & DBB		Side A: SPE / Side B: DPE; DIB-2 & DBB		Side A: SPE / Side B: DPE; DIB-2 & DBB	
21. Bore Type	Full Bore		Full Bore		Full Bore		Full Bore	
22. Body Construction	split body, bolted		split body, bolted		split body, bolted		split body, bolted	
23. Cladding or Coating	Full clad - Inconel 625 weld overlay on all wetted parts		N/A		N/A		N/A	
24. Valve Testing	FAT according A.9.3		FAT according A.9.3		FAT according A.9.3		FAT according A.9.3	
25. Notes	Acceptance criteria for sealing tests see Annex A		Acceptance criteria for sealing tests see Annex A		Acceptance criteria for sealing tests see Annex A		Acceptance criteria for sealing tests see Annex A	

Valve Code	VES-2500-3-D373		VES-2500-3-S252		VES-2500-3-S253		VES-2500-3-S262	
Specs	H12P H12		H3		H3		H3	
1. Valve Type	Ball		Ball		Ball		Ball	
2. Sealing Type	Metal to Metal		Metal to Metal		Metal to Metal		Metal to Metal	
3. Valve Specification Level (VSL)	VSL-3		VSL-3		VSL-3		VSL-3	
4. Ball Mouting	Trunnion		Trunnion		Trunnion		Trunnion	
5. Standard	API 6D		API 6D / IOGP S-562		API 6D / IOGP S-562		API 6D	
6. Size Range (NPS)	2" - 18"		2" - 16"		2" - 16"		2" - 16"	
7. End Connection	2" - 12"	ASME B16.5, RTJ	2" - 12"	ASME B16.5, RTJ	2" - 12"	ASME B16.5, RTJ	2" - 12"	ASME B16.5, RTJ
	14" - 18"	ISO 27509, IX	14" - 16"	ISO 27509, IX	14" - 16"	ISO 27509, IX	14" - 16"	ISO 27509, IX
8. Pressure Class	2500		2500		2500		2500	
9. Temperature	-50°C to 200°C		-30°C to 150°C		-30°C to 150°C		0°C to 210°C	
10. Material Class	Duplex Steel		Stainless Steel		Stainless Steel		Stainless Steel	
11. Body Material	ASTM A182 Gr F55		ASTM A182 Gr F316		ASTM A182 Gr F316		ASTM A182 Gr F316	
12. Obturator Material	Super Duplex (UNS S32760) + Tungsten carbide coating		AISI 316 + Tungsten carbide coating		AISI 316 + Tungsten carbide coating		AISI 316 + Tungsten carbide coating	
13. Seat Material	Super Duplex (UNS S32760) + Tungsten carbide coating		AISI 316 + Tungsten carbide coating		AISI 316 + Tungsten carbide coating		AISI 316 + Tungsten carbide coating	
14. Seat Insert	N/A		N/A		N/A		N/A	
15. Spring (Seat) Material	UNS N07750		UNS N07750		UNS N07750		UNS N07750	
16. Stem Material	ASTM A276 (UNS S32760)		ASTM A276 (UNS S31803)		ASTM B637 (UNS N07718)		ASTM A276 (UNS S31803)	
17. Seat-Stem Seal	Group E (acc. item A.7.1.5.6)		Group B (acc. item A.7.1.5.6)		Group B (acc. item A.7.1.5.6)		Group C (acc. item A.7.1.5.6)	
18. Operator Type	Gearbox		Gearbox		Gearbox		Gearbox	
19. Additional Requirement	Fire Tested (acc. item A.6.1.4)		N/A		Fire Tested (acc. item A.6.1.4)		N/A	
20. Seat Type	Side A: SPE / Side B: DPE; DIB-2 & DBB		Side A: SPE / Side B: DPE; DIB-2 & DBB		Side A: SPE / Side B: DPE; DIB-2 & DBB		Side A: SPE / Side B: DPE; DIB-2 & DBB	
21. Bore Type	Full Bore		Full Bore		Full Bore		Full Bore	
22. Body Construction	split body, bolted		split body, bolted		split body, bolted		split body, bolted	
23. Cladding or Coating	N/A		N/A		N/A		N/A	
24. Valve Testing	FAT according A.9.3		FAT according A.9.3		FAT according A.9.3		FAT according A.9.3	
25. Notes	Acceptance criteria for sealing tests see Annex A		Acceptance criteria for sealing tests see Annex A		Acceptance criteria for sealing tests see Annex A		Acceptance criteria for sealing tests see Annex A	

Valve Code	VES-2500-3-S263		VES-2500-3-S272		VES-2500-3-S273		VES-2502-1-D208
Specs	H3		H3		H3		H16
1. Valve Type	Ball		Ball		Ball		Ball
2. Sealing Type	Metal to Metal		Metal to Metal		Metal to Metal		Soft
3. Valve Specification Level (VSL)	VSL-3		VSL-3		VSL-3		VSL-1
4. Ball Mouting	Trunnion		Trunnion		Trunnion		Trunnion
5. Standard	API 6D		API 6D		API 6D		ASME B16.34 LTD
6. Size Range (NPS)	2" - 16"		2" - 16"		2" - 16"		1" - 1 ½"
7. End Connection	2" - 12"	ASME B16.5, RTJ	2" - 12"	ASME B16.5, RTJ	2" - 12"	ASME B16.5, RTJ	N/A
	14" - 16"	ISO 27509, IX	14" - 16"	ISO 27509, IX	14" - 16"	ISO 27509, IX	N/A
8. Pressure Class	2500		2500		2500		2500
9. Temperature	0°C to 210°C		-100°C to 200°C		-100°C to 200°C		-30°C to 120°C
10. Material Class	Stainless Steel		Stainless Steel		Stainless Steel		Duplex Steel
11. Body Material	ASTM A182 Gr F316		ASTM A182 Gr F316		ASTM A182 Gr F316		ASTM A182 Gr F51
12. Obturator Material	AISI 316 + Tungsten carbide coating		AISI 316 + Tungsten carbide coating		AISI 316 + Tungsten carbide coating		Duplex (UNS S31803)
13. Seat Material	AISI 316 + Tungsten carbide coating		AISI 316 + Tungsten carbide coating		AISI 316 + Tungsten carbide coating		Duplex (UNS S31803)
14. Seat Insert	N/A		N/A		N/A		PEEK
15. Spring (Seat) Material	UNS N07750		UNS N07750		UNS N07750		UNS N07750
16. Stem Material	ASTM B637 (UNS N07718)		ASTM B637 (UNS N07718)		ASTM B637 (UNS N07718)		ASTM A276 (UNS S31803)
17. Seat-Stem Seal	Group C (acc. item A.7.1.5.6)		Group E (acc. item A.7.1.5.6)		Group E (acc. item A.7.1.5.6)		Group B (acc. item A.7.1.5.6)
18. Operator Type	Gearbox		Gearbox		Gearbox		Lever
19. Additional Requirement	Fire Tested (acc. item A.6.1.4)		N/A		Fire Tested (acc. item A.6.1.4)		Fire Tested (acc. item A.6.1.4)
20. Seat Type	Side A: SPE / Side B: DPE; DIB-2 & DBB		Side A: SPE / Side B: DPE; DIB-2 & DBB		Side A: SPE / Side B: DPE; DIB-2 & DBB		Side A: SPE / Side B: SPE
21. Bore Type	Full Bore		Full Bore		Full Bore		Full Bore
22. Body Construction	split body, bolted		split body, bolted		split body, bolted		split body, bolted
23. Cladding or Coating	N/A		N/A		N/A		N/A
24. Valve Testing	FAT according A.9.3		FAT according A.9.3		FAT according A.9.3		FAT according A.9.3
25. Notes	Acceptance criteria for sealing tests see Annex A		Acceptance criteria for sealing tests see Annex A		Acceptance criteria for sealing tests see Annex A		N/A

Valve Code	VES-2502-1-D209	VES-2502-1-N108	VES-2502-1-N109	VES-2502-2-D208
Specs	H16	H30P H30	H30P H30	H16
1. Valve Type	Ball	Ball	Ball	Ball
2. Sealing Type	Metal to Metal	Soft	Metal to Metal	Soft
3. Valve Specification Level (VSL)	VSL-1	VSL-1	VSL-1	VSL-2
4. Ball Mouting	Trunnion	Trunnion	Trunnion	Trunnion
5. Standard	ASME B16.34 LTD	ASME B16.34 LTD	ASME B16.34 LTD	ASME B16.34 LTD
6. Size Range (NPS)	1" - 1 ½"	1" - 1 ½"	1" - 1 ½"	1" - 1 ½"
7. End Connection	butt weld ASME B16.25 with nipple SCH 80S	butt weld ASME B16.25 with nipple SCH 80S	butt weld ASME B16.25 with nipple SCH 80S	butt weld ASME B16.25 with nipple SCH 80S
8. Pressure Class	2500	2500	2500	2500
9. Temperature	-46°C to 150°C	-30°C to 120°C	-46°C to 200°C	-30°C to 120°C
10. Material Class	Duplex Steel	Nickel Alloys	Nickel Alloys	Duplex Steel
11. Body Material	ASTM A182 Gr F51	ASTM B564 (UNS N06625)	ASTM B564 (UNS N06625)	ASTM A182 Gr F51
12. Obturator Material	Duplex (UNS S31803) + Hard Coating (acc. Item A.7.1.7.4)	ASTM B564 (UNS N06625)	ASTM B564 (UNS N06625) + Hard Coating (acc. Item A.7.1.7.4)	Duplex (UNS S31803)
13. Seat Material	Duplex (UNS S31803) + Hard Coating (acc. Item A.7.1.7.4)	ASTM B564 (UNS N06625)	ASTM B564 (UNS N06625) + Hard Coating (acc. Item A.7.1.7.4)	Duplex (UNS S31803)
14. Seat Insert	N/A	PEEK	N/A	PEEK
15. Spring (Seat) Material	UNS N07750	UNS N07750	UNS N07750	UNS N07750
16. Stem Material	ASTM A276 (UNS S31803)	ASTM B637 (UNS N07718)	ASTM B637 (UNS N07718)	ASTM A276 (UNS S31803)
17. Seat-Stem Seal	Group E (acc. item A.7.1.5.6)	Group B (acc. item A.7.1.5.6)	Group E (acc. item A.7.1.5.6)	Group B (acc. item A.7.1.5.6)
18. Operator Type	Lever	Lever	Lever	Lever
19. Additional Requirement	Fire Tested (acc. item A.6.1.4)	Fire Tested (acc. item A.6.1.4)	Fire Tested (acc. item A.6.1.4)	Fire Tested (acc. item A.6.1.4)
20. Seat Type	Side A: SPE / Side B: SPE	Side A: SPE / Side B: SPE	Side A: SPE / Side B: SPE	Side A: SPE / Side B: SPE
21. Bore Type	Full Bore	Full Bore	Full Bore	Full Bore
22. Body Construction	split body, bolted	split body, bolted	split body, bolted	split body, bolted
23. Cladding or Coating	N/A	N/A	N/A	N/A
24. Valve Testing	FAT according A.9.3	FAT according A.9.3	FAT according A.9.3	FAT according A.9.3
25. Notes	N/A	N/A	N/A	N/A

Valve Code	VES-2502-2-D209	VES-2502-2-D308	VES-2502-2-D309	VES-2502-2-N108
Specs	H16	H12P H12	H12P H12	H30P H30
1. Valve Type	Ball	Ball	Ball	Ball
2. Sealing Type	Metal to Metal	Soft	Metal to Metal	Soft
3. Valve Specification Level (VSL)	VSL-2	VSL-2	VSL-2	VSL-2
4. Ball Mouting	Trunnion	Trunnion	Trunnion	Trunnion
5. Standard	ASME B16.34 LTD	ASME B16.34 LTD	ASME B16.34 LTD	ASME B16.34 LTD
6. Size Range (NPS)	1" - 1 ½"	1" - 1 ½"	1" - 1 ½"	1" - 1 ½"
7. End Connection	butt weld ASME B16.25 with nipple SCH 80S	butt weld ASME B16.25 with nipple SCH 80S	butt weld ASME B16.25 with nipple SCH 80S	butt weld ASME B16.25 with nipple SCH 80S
8. Pressure Class	2500	2500	2500	2500
9. Temperature	-46°C to 150°C	0°C to 120°C	-50°C to 200°C	-30°C to 120°C
10. Material Class	Duplex Steel	Duplex Steel	Duplex Steel	Nickel Alloys
11. Body Material	ASTM A182 Gr F51	ASTM A182 Gr F55	ASTM A182 Gr F55	ASTM B564 (UNS N06625)
12. Obturator Material	Duplex (UNS S31803) + Hard Coating (acc. Item A.7.1.7.4)	Super Duplex (UNS S32760)	Super Duplex (UNS S32760) + Hard Coating (acc. Item A.7.1.7.4)	ASTM B564 (UNS N06625)
13. Seat Material	Duplex (UNS S31803) + Hard Coating (acc. Item A.7.1.7.4)	Super Duplex (UNS S32760)	Super Duplex (UNS S32760) + Hard Coating (acc. Item A.7.1.7.4)	ASTM B564 (UNS N06625)
14. Seat Insert	N/A	PEEK	N/A	PEEK
15. Spring (Seat) Material	UNS N07750	UNS N07750	UNS N07750	UNS N07750
16. Stem Material	ASTM A276 (UNS S31803)	ASTM A276 (UNS S32760)	ASTM A276 (UNS S32760)	ASTM B637 (UNS N07718)
17. Seat-Stem Seal	Group E (acc. item A.7.1.5.6)	Group A (acc. item A.7.1.5.6)	Group E (acc. item A.7.1.5.6)	Group B (acc. item A.7.1.5.6)
18. Operator Type	Lever	Lever	Lever	Lever
19. Additional Requirement	Fire Tested (acc. item A.6.1.4)	Fire Tested (acc. item A.6.1.4)	Fire Tested (acc. item A.6.1.4)	Fire Tested (acc. item A.6.1.4)
20. Seat Type	Side A: SPE / Side B: SPE	Side A: SPE / Side B: SPE	Side A: SPE / Side B: SPE	Side A: SPE / Side B: SPE
21. Bore Type	Full Bore	Full Bore	Full Bore	Full Bore
22. Body Construction	split body, bolted	split body, bolted	split body, bolted	split body, bolted
23. Cladding or Coating	N/A	N/A	N/A	N/A
24. Valve Testing	FAT according A.9.3	FAT according A.9.3	FAT according A.9.3	FAT according A.9.3
25. Notes	N/A	N/A	N/A	N/A

Valve Code	VES-2502-2-N109	VES-2502-2-S208	VES-2502-2-S209	VES-2502-3-D209
Specs	H30P H30	H3	H3	H16
1. Valve Type	Ball	Ball	Ball	Ball
2. Sealing Type	Metal to Metal	Soft	Metal to Metal	Metal to Metal
3. Valve Specification Level (VSL)	VSL-2	VSL-2	VSL-2	VSL-3
4. Ball Mouting	Trunnion	Trunnion	Trunnion	Trunnion
5. Standard	ASME B16.34 LTD	ASME B16.34 LTD	ASME B16.34 LTD	ASME B16.34 LTD
6. Size Range (NPS)	1" - 1 ½"	1"	1"	1" - 1 ½"
7. End Connection	butt weld ASME B16.25 with nipple SCH 80S	butt weld ASME B16.25 with nipple SCH 80S	butt weld ASME B16.25 with nipple SCH 80S	butt weld ASME B16.25 with nipple SCH 80S
8. Pressure Class	2500	2500	2500	2500
9. Temperature	-46°C to 200°C	-30°C to 120°C	-100°C to 200°C	-46°C to 150°C
10. Material Class	Nickel Alloys	Stainless Steel	Stainless Steel	Duplex Steel
11. Body Material	ASTM B564 (UNS N06625)	ASTM A182 Gr F316/316L	ASTM A182 Gr F316/316L	ASTM A182 Gr F51
12. Obturator Material	ASTM B564 (UNS N06625) + Hard Coating (acc. Item A.7.1.7.4)	AISI 316	AISI 316 + Hard Coating (acc. Item A.7.1.7.4)	Duplex (UNS S31803) + Hard Coating (acc. Item A.7.1.7.4)
13. Seat Material	ASTM B564 (UNS N06625) + Hard Coating (acc. Item A.7.1.7.4)	AISI 316	AISI 316 + Hard Coating (acc. Item A.7.1.7.4)	Duplex (UNS S31803) + Hard Coating (acc. Item A.7.1.7.4)
14. Seat Insert	N/A	PEEK	N/A	N/A
15. Spring (Seat) Material	UNS N07750	UNS N07750	UNS N07750	UNS N07750
16. Stem Material	ASTM B637 (UNS N07718)	ASTM A564 Type 630 H1150 (UNS S17400)	ASTM A276 (UNS S31600)	ASTM A276 (UNS S31803)
17. Seat-Stem Seal	Group E (acc. item A.7.1.5.6)	Group B (acc. item A.7.1.5.6)	Group E (acc. item A.7.1.5.6)	Group E (acc. item A.7.1.5.6)
18. Operator Type	Lever	Lever	Lever	Lever
19. Additional Requirement	Fire Tested (acc. item A.6.1.4)	Fire Tested (acc. item A.6.1.4)	Fire Tested (acc. item A.6.1.4)	Fire Tested (acc. item A.6.1.4)
20. Seat Type	Side A: SPE / Side B: SPE	Side A: SPE / Side B: SPE	Side A: SPE / Side B: SPE	Side A: SPE / Side B: SPE
21. Bore Type	Full Bore	Full Bore	Full Bore	Full Bore
22. Body Construction	split body, bolted	split body, bolted	split body, bolted	split body, bolted
23. Cladding or Coating	N/A	N/A	N/A	N/A
24. Valve Testing	FAT according A.9.3	FAT according A.9.3	FAT according A.9.3	FAT according A.9.3
25. Notes	N/A	N/A	N/A	N/A

Valve Code	VES-2502-3-D309	VES-2502-3-N109	VES-2502-3-S209	VES-2503-2-C208
Specs	H12P H12	H30P H30	H3	H6
1. Valve Type	Ball	Ball	Ball	Ball
2. Sealing Type	Metal to Metal	Metal to Metal	Metal to Metal	Soft
3. Valve Specification Level (VSL)	VSL-3	VSL-3	VSL-3	VSL-2
4. Ball Mouting	Trunnion	Trunnion	Trunnion	Trunnion
5. Standard	ASME B16.34 LTD	ASME B16.34 LTD	ASME B16.34 LTD	ASME B16.34 LTD
6. Size Range (NPS)	1" - 1 ½"	1" - 1 ½"	1"	1" - 1 ½"
7. End Connection	butt weld ASME B16.25 with nipple SCH 80S	butt weld ASME B16.25 with nipple SCH 80S	butt weld ASME B16.25 with nipple SCH 80S	butt weld ASME B16.25 with nipple SCH 160
8. Pressure Class	2500	2500	2500	2500
9. Temperature	-50°C to 200°C	-46°C to 200°C	-46°C to 200°C	-30°C to 120°C
10. Material Class	Duplex Steel	Nickel Alloys	Stainless Steel	Carbon Steel
11. Body Material	ASTM A182 Gr F55	ASTM B564 (UNS N06625)	ASTM A182 Gr F316/316L	ASTM A350 Gr LF2 CL1
12. Obturator Material	Super Duplex (UNS S32760) + Hard Coating (acc. Item A.7.1.7.4)	ASTM B564 (UNS N06625) + Hard Coating (acc. Item A.7.1.7.4)	AISI 316 + Hard Coating (acc. Item A.7.1.7.4)	AISI 316
13. Seat Material	Super Duplex (UNS S32760) + Hard Coating (acc. Item A.7.1.7.4)	ASTM B564 (UNS N06625) + Hard Coating (acc. Item A.7.1.7.4)	AISI 316 + Hard Coating (acc. Item A.7.1.7.4)	AISI 316
14. Seat Insert	N/A	N/A	N/A	PEEK
15. Spring (Seat) Material	UNS N07750	UNS N07750	UNS N07750	UNS N07750
16. Stem Material	ASTM A276 (UNS S32760)	ASTM B637 (UNS N07718)	ASTM A564 Type 630 H1150 (UNS S17400)	ASTM A276 (UNS S31803)
17. Seat-Stem Seal	Group E (acc. item A.7.1.5.6)	Group E (acc. item A.7.1.5.6)	Group E (acc. item A.7.1.5.6)	Group B (acc. item A.7.1.5.6)
18. Operator Type	Lever	Lever	Lever	Lever
19. Additional Requirement	Fire Tested (acc. item A.6.1.4)	Fire Tested (acc. item A.6.1.4)	Fire Tested (acc. item A.6.1.4)	Fire Tested (acc. item A.6.1.4)
20. Seat Type	Side A: SPE / Side B: SPE	Side A: SPE / Side B: SPE	Side A: SPE / Side B: SPE	Side A: SPE / Side B: SPE
21. Bore Type	Full Bore	Full Bore	Full Bore	Full Bore
22. Body Construction	split body, bolted	split body, bolted	split body, bolted	split body, bolted
23. Cladding or Coating	N/A	N/A	N/A	N/A
24. Valve Testing	FAT according A.9.3	FAT according A.9.3	FAT according A.9.3	FAT according A.9.3
25. Notes	N/A	N/A	N/A	N/A

Valve Code	VES-2503-2-C209	VES-2503-2-S208	VES-2503-2-S209	VES-2503-3-C209
Specs	H6	H3	H3	H6
1. Valve Type	Ball	Ball	Ball	Ball
2. Sealing Type	Metal to Metal	Soft	Metal to Metal	Metal to Metal
3. Valve Specification Level (VSL)	VSL-2	VSL-2	VSL-2	VSL-3
4. Ball Mouting	Trunnion	Trunnion	Trunnion	Trunnion
5. Standard	ASME B16.34 LTD	ASME B16.34 LTD	ASME B16.34 LTD	ASME B16.34 LTD
6. Size Range (NPS)	1" - 1 ½"	1" - 1 ½"	1" - 1 ½"	1" - 1 ½"
7. End Connection	butt weld ASME B16.25 with nipple SCH 160	butt weld ASME B16.25 with nipple SCH 160	butt weld ASME B16.25 with nipple SCH 160	butt weld ASME B16.25 with nipple SCH 160
8. Pressure Class	2500	2500	2500	2500
9. Temperature	-46°C to 200°C	-30°C to 120°C	-46°C to 200°C	-46°C to 200°C
10. Material Class	Carbon Steel	Stainless Steel	Stainless Steel	Carbon Steel
11. Body Material	ASTM A350 Gr LF2 CL1	ASTM A182 Gr F316/316L	ASTM A182 Gr F316/316L	ASTM A350 Gr LF2 CL1
12. Obturator Material	AISI 316 + Hard Coating (acc. Item A.7.1.7.4)	AISI 316	AISI 316 + Hard Coating (acc. Item A.7.1.7.4)	AISI 316 + Hard Coating (acc. Item A.7.1.7.4)
13. Seat Material	AISI 316 + Hard Coating (acc. Item A.7.1.7.4)	AISI 316	AISI 316 + Hard Coating (acc. Item A.7.1.7.4)	AISI 316 + Hard Coating (acc. Item A.7.1.7.4)
14. Seat Insert	N/A	PEEK	N/A	N/A
15. Spring (Seat) Material	UNS N07750	UNS N07750	UNS N07750	UNS N07750
16. Stem Material	ASTM A276 (UNS S31803)	ASTM A276 (UNS S31803)	ASTM A276 (UNS S31803)	ASTM A276 (UNS S31803)
17. Seat-Stem Seal	Group E (acc. item A.7.1.5.6)	Group B (acc. item A.7.1.5.6)	Group E (acc. item A.7.1.5.6)	Group E (acc. item A.7.1.5.6)
18. Operator Type	Lever	Lever	Lever	Lever
19. Additional Requirement	Fire Tested (acc. item A.6.1.4)	Fire Tested (acc. item A.6.1.4)	Fire Tested (acc. item A.6.1.4)	Fire Tested (acc. item A.6.1.4)
20. Seat Type	Side A: SPE / Side B: SPE	Side A: SPE / Side B: SPE	Side A: SPE / Side B: SPE	Side A: SPE / Side B: SPE
21. Bore Type	Full Bore	Full Bore	Full Bore	Full Bore
22. Body Construction	split body, bolted	split body, bolted	split body, bolted	split body, bolted
23. Cladding or Coating	N/A	N/A	N/A	N/A
24. Valve Testing	FAT according A.9.3	FAT according A.9.3	FAT according A.9.3	FAT according A.9.3
25. Notes	N/A	N/A	N/A	N/A

Valve Code	VES-2503-3-S209	VES-2504-2-C108	VES-2510-2-C114	VES-2510-2-C118
Specs	H3	H10	H10	H10
1. Valve Type	Ball	Ball	Ball	Ball
2. Sealing Type	Metal to Metal	Soft	Soft	Soft
3. Valve Specification Level (VSL)	VSL-3	VSL-2	VSL-2	VSL-2
4. Ball Mouting	Trunnion	Trunnion	N/A	N/A
5. Standard	ASME B16.34 LTD	ASME B16.34 LTD	API 6D / IOGP S-562	API 6D / IOGP S-562
6. Size Range (NPS)	1" - 1 ½"	1" - 1 ½"	2" - 20"	2" - 20"
7. End Connection	butt weld ASME B16.25 with nipple SCH 160	butt weld ASME B16.25 with nipple SCH XXS	N/A	N/A
8. Pressure Class	2500	2500	2500	2500
9. Temperature	-100°C to 200°C	-29°C to 120°C	-29°C to 120°C	0°C to 120°C
10. Material Class	Stainless Steel	Carbon Steel	Carbon Steel	Carbon Steel
11. Body Material	ASTM A182 Gr F316/316L	ASTM A105	ASTM A105	ASTM A105
12. Obturator Material	AISI 316 + Hard Coating (acc. Item A.7.1.7.4)	AISI 410 + Hard Coating (acc. Item A.7.1.7.4)	AISI 410 + Hard Coating (acc. Item A.7.1.7.4)	AISI 410 + Hard Coating (acc. Item A.7.1.7.4)
13. Seat Material	AISI 316 + Hard Coating (acc. Item A.7.1.7.4)	AISI 410 + Hard Coating (acc. Item A.7.1.7.4)	AISI 410 + Hard Coating (acc. Item A.7.1.7.4)	AISI 410 + Hard Coating (acc. Item A.7.1.7.4)
14. Seat Insert	N/A	PEEK	PEEK	PEEK
15. Spring (Seat) Material	UNS N07750	UNS N07750	UNS N07750	UNS N07750
16. Stem Material	ASTM B637 (UNS N07718)	ASTM A276 (UNS S41000)	ASTM A276 (UNS S41000)	ASTM A276 (UNS S41000)
17. Seat-Stem Seal	Group E (acc. item A.7.1.5.6)	Group B (acc. item A.7.1.5.6)	Group B (acc. item A.7.1.5.6)	Group A (acc. item A.7.1.5.6)
18. Operator Type	Lever	Lever	Gearbox	Gearbox
19. Additional Requirement	Fire Tested (acc. item A.6.1.4)	Fire Tested (acc. item A.6.1.4)	N/A	N/A
20. Seat Type	Side A: SPE / Side B: SPE	Side A: SPE / Side B: SPE	Side A: SPE / Side B: SPE; DBB	Side A: SPE / Side B: DPE; DIB-2 & DBB
21. Bore Type	Full Bore	Full Bore	Full Bore	Full Bore
22. Body Construction	split body, bolted	split body, bolted	split body, bolted	split body, bolted
23. Cladding or Coating	N/A	N/A	Partial clad - SS316 weld overlay on all body sealing areas	Partial clad - SS316 weld overlay on all body sealing areas
24. Valve Testing	FAT according A.9.3	FAT according A.9.3	FAT according A.9.3	FAT according A.9.3
25. Notes	N/A	N/A	N/A	N/A

Valve Code	VES-2510-2-C134	VES-2510-2-C138	VES-2510-2-C150	VES-2510-2-C152
Specs	H10	H10	H10	H10
1. Valve Type	Ball	Ball	Ball	Ball
2. Sealing Type	Soft	Soft	Metal to Metal	Metal to Metal
3. Valve Specification Level (VSL)	VSL-2	VSL-2	VSL-2	VSL-2
4. Ball Mouting	N/A	N/A	N/A	N/A
5. Standard	API 6D / IOGP S-562	API 6D / IOGP S-562	API 6D / IOGP S-562	API 6D / IOGP S-562
6. Size Range (NPS)	2" - 20"	2" - 20"	2" - 20"	2" - 20"
7. End Connection	ISO 27509, IX	ISO 27509, IX	ISO 27509, IX	ISO 27509, IX
8. Pressure Class	2500	2500	2500	2500
9. Temperature	0°C to 120°C	0°C to 120°C	-29°C to 150°C	0°C to 150°C
10. Material Class	Carbon Steel	Carbon Steel	Carbon Steel	Carbon Steel
11. Body Material	ASTM A105 + SS316 weld overlay (acc. item A.7.1.7.3)	ASTM A105 + SS316 weld overlay (acc. item A.7.1.7.3)	ASTM A105 + SS316 weld overlay (acc. item A.7.1.7.3)	ASTM A105 + SS316 weld overlay (acc. item A.7.1.7.3)
12. Obturator Material	AISI 410 + Hard Coating (acc. Item A.7.1.7.4)	AISI 410 + Hard Coating (acc. Item A.7.1.7.4)	AISI 410 + Tungsten carbide coating	AISI 410 + Tungsten carbide coating
13. Seat Material	AISI 410	AISI 410	AISI 410 + Tungsten carbide coating	AISI 410 + Tungsten carbide coating
14. Seat Insert	PEEK	PEEK	N/A	N/A
15. Spring (Seat) Material	UNS N07750	UNS N07750	UNS N07750	UNS N07750
16. Stem Material	ASTM A276 (UNS S41000)	ASTM A276 (UNS S41000)	ASTM A276 (UNS S41000)	ASTM A276 (UNS S41000)
17. Seat-Stem Seal	Group D (acc. item A.7.1.5.6)	Group D (acc. item A.7.1.5.6)	Group B (acc. item A.7.1.5.6)	Group A (acc. item A.7.1.5.6)
18. Operator Type	Gearbox	Gearbox	Gearbox	Gearbox
19. Additional Requirement	N/A	N/A	N/A	N/A
20. Seat Type	Side A: SPE / Side B: SPE; DBB	Side A: SPE / Side B: DPE; DIB-2 & DBB	Side A: SPE / Side B: SPE	Side A: SPE / Side B: DPE; DIB-2 & DBB
21. Bore Type	Full Bore	Full Bore	Full Bore	Full Bore
22. Body Construction	split body, bolted	split body, bolted	split body, bolted	split body, bolted
23. Cladding or Coating	Partial clad - SS316 weld overlay on all body sealing areas	Partial clad - SS316 weld overlay on all body sealing areas	Partial clad - SS316 weld overlay on all body sealing areas	Partial clad - SS316 weld overlay on all body sealing areas
24. Valve Testing	FAT according A.9.3	FAT according A.9.3	FAT according A.9.3	FAT according A.9.3
25. Notes	N/A	N/A	N/A	N/A

Valve Code	VES-2510-2-C160	VES-2510-2-C162	VES-2510-2-C170	VES-2510-2-C172
Specs	H10	H10	H10	H10
1. Valve Type	Ball	Ball	Ball	Ball
2. Sealing Type	Metal to Metal	Metal to Metal	Metal to Metal	Metal to Metal
3. Valve Specification Level (VSL)	VSL-2	VSL-2	VSL-2	VSL-2
4. Ball Mouting	N/A	N/A	N/A	N/A
5. Standard	API 6D	API 6D	API 6D	API 6D
6. Size Range (NPS)	2" - 20"	2" - 20"	2" - 20"	2" - 20"
7. End Connection	ISO 27509, IX	ISO 27509, IX	ISO 27509, IX	ISO 27509, IX
8. Pressure Class	2500	2500	2500	2500
9. Temperature	0°C to 210°C	0°C to 210°C	0°C to 210°C	0°C to 210°C
10. Material Class	Carbon Steel	Carbon Steel	Carbon Steel	Carbon Steel
11. Body Material	ASTM A105 + SS316 weld overlay (acc. item A.7.1.7.3)	ASTM A105 + SS316 weld overlay (acc. item A.7.1.7.3)	ASTM A105 + SS316 weld overlay (acc. item A.7.1.7.3)	ASTM A105 + SS316 weld overlay (acc. item A.7.1.7.3)
12. Obturator Material	AISI 410 + Tungsten carbide coating	AISI 410 + Tungsten carbide coating	AISI 410 + Tungsten carbide coating	AISI 410 + Tungsten carbide coating
13. Seat Material	AISI 410 + Tungsten carbide coating	AISI 410 + Tungsten carbide coating	AISI 410 + Tungsten carbide coating	AISI 410 + Tungsten carbide coating
14. Seat Insert	N/A	N/A	N/A	N/A
15. Spring (Seat) Material	UNS N07750	UNS N07750	UNS N07750	UNS N07750
16. Stem Material	ASTM A276 (UNS S41000)	ASTM A276 (UNS S41000)	ASTM A276 (UNS S41000)	ASTM A276 (UNS S41000)
17. Seat-Stem Seal	Group C (acc. item A.7.1.5.6)	Group C (acc. item A.7.1.5.6)	Group D (acc. item A.7.1.5.6)	Group D (acc. item A.7.1.5.6)
18. Operator Type	Gearbox	Gearbox	Gearbox	Gearbox
19. Additional Requirement	N/A	N/A	N/A	N/A
20. Seat Type	Side A: SPE / Side B: SPE	Side A: SPE / Side B: DPE; DIB-2 & DBB	Side A: SPE / Side B: SPE	Side A: SPE / Side B: DPE; DIB-2 & DBB
21. Bore Type	Full Bore	Full Bore	Full Bore	Full Bore
22. Body Construction	split body, bolted	split body, bolted	split body, bolted	split body, bolted
23. Cladding or Coating	Partial clad - SS316 weld overlay on all body sealing areas	Partial clad - SS316 weld overlay on all body sealing areas	Partial clad - SS316 weld overlay on all body sealing areas	Partial clad - SS316 weld overlay on all body sealing areas
24. Valve Testing	FAT according A.9.3	FAT according A.9.3	FAT according A.9.3	FAT according A.9.3
25. Notes	N/A	N/A	N/A	N/A

Valve Code	VES-2510-2-C214	VES-2510-2-C218	VES-2510-2-C234	VES-2510-2-C238
Specs	H6	H6	H6	H6
1. Valve Type	Ball	Ball	Ball	Ball
2. Sealing Type	Soft	Soft	Soft	Soft
3. Valve Specification Level (VSL)	VSL-2	VSL-2	VSL-2	VSL-2
4. Ball Mouting	Trunnion	N/A	N/A	N/A
5. Standard	API 6D / IOGP S-562	API 6D / IOGP S-562	API 6D / IOGP S-562	API 6D / IOGP S-562
6. Size Range (NPS)	2" - 18"	2" - 18"	2" - 18"	2" - 18"
7. End Connection	ISO 27509, IX	ISO 27509, IX	ISO 27509, IX	ISO 27509, IX
8. Pressure Class	2500	2500	2500	2500
9. Temperature	-30°C to 120°C	-30°C to 120°C	-46°C to 120°C	-46°C to 120°C
10. Material Class	Carbon Steel	Carbon Steel	Carbon Steel	Carbon Steel
11. Body Material	ASTM A350 Gr LF2 CL1 + Inconel 625 weld overlay (acc. item A.7.1.7.3)	ASTM A350 Gr LF2 CL1 + Inconel 625 weld overlay (acc. item A.7.1.7.3)	ASTM A350 Gr LF2 CL1 + Inconel 625 weld overlay (acc. item A.7.1.7.3)	ASTM A350 Gr LF2 CL1 + Inconel 625 weld overlay (acc. item A.7.1.7.3)
12. Obturator Material	AISI 316	AISI 316	AISI 316	AISI 316
13. Seat Material	AISI 316	AISI 316	AISI 316	AISI 316
14. Seat Insert	PEEK	PEEK	PEEK	PEEK
15. Spring (Seat) Material	UNS N07750	UNS N07750	UNS N07750	UNS N07750
16. Stem Material	ASTM A276 (UNS S31803)	ASTM A276 (UNS S31803)	ASTM A276 (UNS S31803)	ASTM A276 (UNS S31803)
17. Seat-Stem Seal	Group B (acc. item A.7.1.5.6)	Group B (acc. item A.7.1.5.6)	Group E (acc. item A.7.1.5.6)	Group E (acc. item A.7.1.5.6)
18. Operator Type	Gearbox	Gearbox	Gearbox	Gearbox
19. Additional Requirement	N/A	N/A	N/A	N/A
20. Seat Type	Side A: SPE / Side B: SPE; DBB	Side A: SPE / Side B: DPE; DIB-2 & DBB	Side A: SPE / Side B: SPE; DBB	Side A: SPE / Side B: DPE; DIB-2 & DBB
21. Bore Type	Full Bore	Full Bore	Full Bore	Full Bore
22. Body Construction	split body, bolted	split body, bolted	split body, bolted	split body, bolted
23. Cladding or Coating	Partial clad - Inconel 625 weld overlay on all body sealing areas	Partial clad - Inconel 625 weld overlay on all body sealing areas	Partial clad - Inconel 625 weld overlay on all body sealing areas	Partial clad - Inconel 625 weld overlay on all body sealing areas
24. Valve Testing	FAT according A.9.3	FAT according A.9.3	FAT according A.9.3	FAT according A.9.3
25. Notes	N/A	N/A	N/A	N/A

Valve Code	VES-2510-2-C250	VES-2510-2-C252	VES-2510-2-C270	VES-2510-2-C272
Specs	H6	H6	H6	H6
1. Valve Type	Ball	Ball	Ball	Ball
2. Sealing Type	Metal to Metal	Metal to Metal	Metal to Metal	Metal to Metal
3. Valve Specification Level (VSL)	VSL-2	VSL-2	VSL-2	VSL-2
4. Ball Mouting	N/A	N/A	N/A	N/A
5. Standard	API 6D / IOGP S-562	API 6D / IOGP S-562	API 6D	API 6D
6. Size Range (NPS)	2" - 18"	2" - 18"	2" - 18"	2" - 18"
7. End Connection	ISO 27509, IX	ISO 27509, IX	ISO 27509, IX	ISO 27509, IX
8. Pressure Class	2500	2500	2500	2500
9. Temperature	-30°C to 150°C	-30°C to 150°C	-46°C to 200°C	-46°C to 200°C
10. Material Class	Carbon Steel	Carbon Steel	Carbon Steel	Carbon Steel
11. Body Material	ASTM A350 Gr LF2 CL1 + Inconel 625 weld overlay (acc. item A.7.1.7.3)	ASTM A350 Gr LF2 CL1 + Inconel 625 weld overlay (acc. item A.7.1.7.3)	ASTM A350 Gr LF2 CL1 + Inconel 625 weld overlay (acc. item A.7.1.7.3)	ASTM A350 Gr LF2 CL1 + Inconel 625 weld overlay (acc. item A.7.1.7.3)
12. Obturator Material	AISI 316 + Tungsten carbide coating	AISI 316 + Tungsten carbide coating	AISI 316 + Tungsten carbide coating	AISI 316 + Tungsten carbide coating
13. Seat Material	AISI 316 + Tungsten carbide coating	AISI 316 + Tungsten carbide coating	AISI 316 + Tungsten carbide coating	AISI 316 + Tungsten carbide coating
14. Seat Insert	N/A	N/A	N/A	N/A
15. Spring (Seat) Material	UNS N07750	UNS N07750	UNS N07750	UNS N07750
16. Stem Material	ASTM B637 (UNS N07718)	ASTM B637 (UNS N07718)	ASTM B637 (UNS N07718)	ASTM B637 (UNS N07718)
17. Seat-Stem Seal	Group B (acc. item A.7.1.5.6)	Group B (acc. item A.7.1.5.6)	Group E (acc. item A.7.1.5.6)	Group E (acc. item A.7.1.5.6)
18. Operator Type	Gearbox	Gearbox	Gearbox	Gearbox
19. Additional Requirement	N/A	N/A	N/A	N/A
20. Seat Type	Side A: SPE / Side B: SPE	Side A: SPE / Side B: DPE; DIB-2 & DBB	Side A: SPE / Side B: SPE	Side A: SPE / Side B: DPE; DIB-2 & DBB
21. Bore Type	Full Bore	Full Bore	Full Bore	Full Bore
22. Body Construction	split body, bolted	split body, bolted	split body, bolted	split body, bolted
23. Cladding or Coating	Partial clad - Inconel 625 weld overlay on all body sealing areas	Partial clad - Inconel 625 weld overlay on all body sealing areas	Partial clad - Inconel 625 weld overlay on all body sealing areas	Partial clad - Inconel 625 weld overlay on all body sealing areas
24. Valve Testing	FAT according A.9.3	FAT according A.9.3	FAT according A.9.3	FAT according A.9.3
25. Notes	N/A	N/A	N/A	N/A

Valve Code	VES-2510-2-C534	VES-2510-2-C538	VES-2510-2-C570	VES-2510-2-C572
Specs	H30P H30	H30P H30	H30P H30	H30P H30
1. Valve Type	Ball	Ball	Ball	Ball
2. Sealing Type	Soft	Soft	Metal to Metal	Metal to Metal
3. Valve Specification Level (VSL)	VSL-2	VSL-2	VSL-2	VSL-2
4. Ball Mouting	N/A	N/A	N/A	N/A
5. Standard	API 6D / IOGP S-562	API 6D / IOGP S-562	API 6D	API 6D
6. Size Range (NPS)	2" - 24"	2" - 24"	2" - 24"	2" - 24"
7. End Connection	ISO 27509, IX	ISO 27509, IX	ISO 27509, IX	ISO 27509, IX
8. Pressure Class	2500	2500	2500	2500
9. Temperature	-29°C to 120°C	-29°C to 120°C	-29°C to 200°C	-29°C to 200°C
10. Material Class	Carbon Steel	Carbon Steel	Carbon Steel	Carbon Steel
11. Body Material	ASTM A105 + Inconel 625 weld overlay (acc. item A.7.1.7.3)	ASTM A105 + Inconel 625 weld overlay (acc. item A.7.1.7.3)	ASTM A105 + Inconel 625 weld overlay (acc. item A.7.1.7.3)	ASTM A105 + Inconel 625 weld overlay (acc. item A.7.1.7.3)
12. Obturator Material	ASTM A105 + Inconel 625 weld overlay (acc. item A.7.1.7.3)	ASTM A105 + Inconel 625 weld overlay (acc. item A.7.1.7.3)	ASTM A105 + Inconel 625 weld overlay (acc. item A.7.1.7.3) + Tungsten carbide coating	ASTM A105 + Inconel 625 weld overlay (acc. item A.7.1.7.3) + Tungsten carbide coating
13. Seat Material	ASTM A105 + Inconel 625 weld overlay (acc. item A.7.1.7.3)	ASTM A105 + Inconel 625 weld overlay (acc. item A.7.1.7.3)	ASTM A105 + Inconel 625 weld overlay (acc. item A.7.1.7.3) + Tungsten carbide coating	ASTM A105 + Inconel 625 weld overlay (acc. item A.7.1.7.3) + Tungsten carbide coating
14. Seat Insert	PEEK	PEEK	N/A	N/A
15. Spring (Seat) Material	UNS N07750	UNS N07750	UNS N07750	UNS N07750
16. Stem Material	ASTM B637 (UNS N07718)	ASTM B637 (UNS N07718)	ASTM B637 (UNS N07718)	ASTM B637 (UNS N07718)
17. Seat-Stem Seal	Group E (acc. item A.7.1.5.6)	Group E (acc. item A.7.1.5.6)	Group E (acc. item A.7.1.5.6)	Group E (acc. item A.7.1.5.6)
18. Operator Type	Gearbox	Gearbox	Gearbox	Gearbox
19. Additional Requirement	N/A	N/A	N/A	N/A
20. Seat Type	Side A: SPE / Side B: SPE; DBB	Side A: SPE / Side B: DPE; DIB-2 & DBB	Side A: SPE / Side B: SPE	Side A: SPE / Side B: DPE; DIB-2 & DBB
21. Bore Type	Full Bore	Full Bore	Full Bore	Full Bore
22. Body Construction	split body, bolted	split body, bolted	split body, bolted	split body, bolted
23. Cladding or Coating	Full clad - Inconel 625 weld overlay on all wetted parts	Full clad - Inconel 625 weld overlay on all wetted parts	Full clad - Inconel 625 weld overlay on all wetted parts	Full clad - Inconel 625 weld overlay on all wetted parts
24. Valve Testing	FAT according A.9.3	FAT according A.9.3	FAT according A.9.3	FAT according A.9.3
25. Notes	N/A	N/A	N/A	N/A

Valve Code	VES-2510-2-D214	VES-2510-2-D218	VES-2510-2-D234	VES-2510-2-D238
Specs	H16	H16	H16	H16
1. Valve Type	Ball	Ball	Ball	Ball
2. Sealing Type	Soft	Soft	Soft	Soft
3. Valve Specification Level (VSL)	VSL-2	VSL-2	VSL-2	VSL-2
4. Ball Mouting	N/A	N/A	N/A	N/A
5. Standard	API 6D / IOGP S-562	API 6D / IOGP S-562	API 6D / IOGP S-562	API 6D / IOGP S-562
6. Size Range (NPS)	2" - 12"	2" - 12"	2" - 12"	2" - 12"
7. End Connection	ISO 27509, IX	ISO 27509, IX	ISO 27509, IX	ISO 27509, IX
8. Pressure Class	2500	2500	2500	2500
9. Temperature	0°C to 120°C	-30°C to 120°C	-46°C to 120°C	-46°C to 120°C
10. Material Class	Duplex Steel	Duplex Steel	Duplex Steel	Duplex Steel
11. Body Material	ASTM A182 Gr F51	ASTM A182 Gr F51	ASTM A182 Gr F51	ASTM A182 Gr F51
12. Obturator Material	Duplex (UNS S31803)	Duplex (UNS S31803)	Duplex (UNS S31803)	Duplex (UNS S31803)
13. Seat Material	Duplex (UNS S31803)	Super Duplex (UNS S32760)	Super Duplex (UNS S32760)	Super Duplex (UNS S32760)
14. Seat Insert	PEEK	PEEK	PEEK	PEEK
15. Spring (Seat) Material	UNS N07750	UNS N07750	UNS N07750	UNS N07750
16. Stem Material	ASTM A276 (UNS S31803)	ASTM A276 (UNS S31803)	ASTM A276 (UNS S31803)	ASTM A276 (UNS S31803)
17. Seat-Stem Seal	Group B (acc. item A.7.1.5.6)	Group B (acc. item A.7.1.5.6)	Group E (acc. item A.7.1.5.6)	Group E (acc. item A.7.1.5.6)
18. Operator Type	Gearbox	Gearbox	Gearbox	Gearbox
19. Additional Requirement	N/A	N/A	N/A	N/A
20. Seat Type	Side A: SPE / Side B: SPE; DBB	Side A: SPE / Side B: DPE; DIB-2 & DBB	Side A: SPE / Side B: SPE; DBB	Side A: SPE / Side B: DPE; DIB-2 & DBB
21. Bore Type	Full Bore	Full Bore	Full Bore	Full Bore
22. Body Construction	split body, bolted	split body, bolted	split body, bolted	split body, bolted
23. Cladding or Coating	N/A	N/A	N/A	N/A
24. Valve Testing	FAT according A.9.3	FAT according A.9.3	FAT according A.9.3	FAT according A.9.3
25. Notes	N/A	N/A	N/A	N/A

Valve Code	VES-2510-2-D270	VES-2510-2-D272	VES-2510-2-D314	VES-2510-2-D318
Specs	H16	H16	H12P H12	H12P H12
1. Valve Type	Ball	Ball	Ball	Ball
2. Sealing Type	Metal to Metal	Metal to Metal	Soft	Soft
3. Valve Specification Level (VSL)	VSL-2	VSL-2	VSL-2	VSL-2
4. Ball Mouting	N/A	N/A	N/A	N/A
5. Standard	API 6D	API 6D	API 6D / IOGP S-562	API 6D / IOGP S-562
6. Size Range (NPS)	2" - 12"	2" - 12"	2" - 18"	2" - 18"
7. End Connection	ISO 27509, IX	ISO 27509, IX	ISO 27509, IX	ISO 27509, IX
8. Pressure Class	2500	2500	2500	2500
9. Temperature	-50°C to 200°C	-50°C to 200°C	-30°C to 120°C	-30°C to 120°C
10. Material Class	Duplex Steel	Duplex Steel	Duplex Steel	Duplex Steel
11. Body Material	ASTM A182 Gr F51	ASTM A182 Gr F51	ASTM A182 Gr F55	ASTM A182 Gr F55
12. Obturator Material	Duplex (UNS S31803) + Tungsten carbide coating	Duplex (UNS S31803) + Tungsten carbide coating	Super Duplex (UNS S32760)	Super Duplex (UNS S32760)
13. Seat Material	Super Duplex (UNS S32760) + Tungsten carbide coating	Super Duplex (UNS S32760) + Tungsten carbide coating	Super Duplex (UNS S32760)	Super Duplex (UNS S32760)
14. Seat Insert	N/A	N/A	PEEK	PEEK
15. Spring (Seat) Material	UNS N07750	UNS N07750	UNS N07750	UNS N07750
16. Stem Material	ASTM A276 (UNS S31803)	ASTM A276 (UNS S31803)	ASTM A276 (UNS S32760)	ASTM A276 (UNS S32760)
17. Seat-Stem Seal	Group E (acc. item A.7.1.5.6)	Group E (acc. item A.7.1.5.6)	Group B (acc. item A.7.1.5.6)	Group B (acc. item A.7.1.5.6)
18. Operator Type	Gearbox	Gearbox	Gearbox	Gearbox
19. Additional Requirement	N/A	N/A	N/A	N/A
20. Seat Type	Side A: SPE / Side B: SPE	Side A: SPE / Side B: DPE; DIB-2 & DBB	Side A: SPE / Side B: SPE; DBB	Side A: SPE / Side B: DPE; DIB-2 & DBB
21. Bore Type	Full Bore	Full Bore	Full Bore	Full Bore
22. Body Construction	split body, bolted	split body, bolted	split body, bolted	split body, bolted
23. Cladding or Coating	N/A	N/A	N/A	N/A
24. Valve Testing	FAT according A.9.3	FAT according A.9.3	FAT according A.9.3	FAT according A.9.3
25. Notes	N/A	N/A	N/A	N/A

Valve Code	VES-2510-2-D334	VES-2510-2-D338	VES-2510-2-D350	VES-2510-2-D352
Specs	H12P H12	H12P H12	H12P H12	H12P H12
1. Valve Type	Ball	Ball	Ball	Ball
2. Sealing Type	Soft	Soft	Metal to Metal	Metal to Metal
3. Valve Specification Level (VSL)	VSL-2	VSL-2	VSL-2	VSL-2
4. Ball Mouting	N/A	N/A	N/A	N/A
5. Standard	API 6D / IOGP S-562	API 6D / IOGP S-562	API 6D / IOGP S-562	API 6D / IOGP S-562
6. Size Range (NPS)	2" - 18"	2" - 18"	2" - 18"	2" - 18"
7. End Connection	ISO 27509, IX	ISO 27509, IX	ISO 27509, IX	ISO 27509, IX
8. Pressure Class	2500	2500	2500	2500
9. Temperature	-46°C to 120°C	-46°C to 120°C	-30°C to 150°C	-30°C to 150°C
10. Material Class	Duplex Steel	Duplex Steel	Duplex Steel	Duplex Steel
11. Body Material	ASTM A182 Gr F55	ASTM A182 Gr F55	ASTM A182 Gr F55	ASTM A182 Gr F55
12. Obturator Material	Super Duplex (UNS S32760)	Super Duplex (UNS S32760)	Super Duplex (UNS S32760) + Tungsten carbide coating	Super Duplex (UNS S32760) + Tungsten carbide coating
13. Seat Material	Super Duplex (UNS S32760)	Super Duplex (UNS S32760)	Super Duplex (UNS S32760) + Tungsten carbide coating	Super Duplex (UNS S32760) + Tungsten carbide coating
14. Seat Insert	PEEK	PEEK	N/A	N/A
15. Spring (Seat) Material	UNS N07750	UNS N07750	UNS N07750	UNS N07750
16. Stem Material	ASTM A276 (UNS S32760)	ASTM A276 (UNS S32760)	ASTM A276 (UNS S32760)	ASTM A276 (UNS S32760)
17. Seat-Stem Seal	Group E (acc. item A.7.1.5.6)	Group E (acc. item A.7.1.5.6)	Group B (acc. item A.7.1.5.6)	Group B (acc. item A.7.1.5.6)
18. Operator Type	Gearbox	Gearbox	Gearbox	Gearbox
19. Additional Requirement	N/A	N/A	N/A	N/A
20. Seat Type	Side A: SPE / Side B: SPE; DBB	Side A: SPE / Side B: DPE; DIB-2 & DBB	Side A: SPE / Side B: SPE	Side A: SPE / Side B: DPE; DIB-2 & DBB
21. Bore Type	Full Bore	Full Bore	Full Bore	Full Bore
22. Body Construction	split body, bolted	split body, bolted	split body, bolted	split body, bolted
23. Cladding or Coating	N/A	N/A	N/A	N/A
24. Valve Testing	FAT according A.9.3	FAT according A.9.3	FAT according A.9.3	FAT according A.9.3
25. Notes	N/A	N/A	N/A	N/A

Valve Code	VES-2510-2-D370	VES-2510-2-D372	VES-2510-2-S214	VES-2510-2-S215
Specs	H12P H12	H12P H12	H3	H3
1. Valve Type	Ball	Ball	Ball	Ball
2. Sealing Type	Metal to Metal	Metal to Metal	Soft	Soft
3. Valve Specification Level (VSL)	VSL-2	VSL-2	VSL-2	VSL-2
4. Ball Mouting	N/A	N/A	N/A	N/A
5. Standard	API 6D	API 6D	API 6D / IOGP S-562	API 6D / IOGP S-562
6. Size Range (NPS)	2" - 18"	2" - 18"	2" - 16"	2" - 16"
7. End Connection	ISO 27509, IX	ISO 27509, IX	ISO 27509, IX	ISO 27509, IX
8. Pressure Class	2500	2500	2500	2500
9. Temperature	-50°C to 200°C	-50°C to 200°C	-30°C to 120°C	-30°C to 120°C
10. Material Class	Duplex Steel	Duplex Steel	Stainless Steel	Stainless Steel
11. Body Material	ASTM A182 Gr F55	ASTM A182 Gr F55	ASTM A182 Gr F316	ASTM A182 Gr F316
12. Obturator Material	Super Duplex (UNS S32760) + Tungsten carbide coating	Super Duplex (UNS S32760) + Tungsten carbide coating	Duplex (UNS S31803)	Duplex (UNS S31803)
13. Seat Material	Super Duplex (UNS S32760) + Tungsten carbide coating	Super Duplex (UNS S32760) + Tungsten carbide coating	Duplex (UNS S31803)	Duplex (UNS S31803)
14. Seat Insert	N/A	N/A	PEEK	PEEK
15. Spring (Seat) Material	UNS N07750	UNS N07750	UNS N07750	UNS N07750
16. Stem Material	ASTM A276 (UNS S32760)	ASTM A276 (UNS S32760)	ASTM A276 (UNS S31803)	ASTM A276 (UNS S31803)
17. Seat-Stem Seal	Group E (acc. item A.7.1.5.6)	Group E (acc. item A.7.1.5.6)	Group B (acc. item A.7.1.5.6)	Group B (acc. item A.7.1.5.6)
18. Operator Type	Gearbox	Gearbox	Gearbox	Gearbox
19. Additional Requirement	N/A	N/A	N/A	Fire Tested (acc. item A.6.1.4)
20. Seat Type	Side A: SPE / Side B: SPE	Side A: SPE / Side B: DPE; DIB-2 & DBB	Side A: SPE / Side B: SPE; DBB	Side A: SPE / Side B: SPE; DBB
21. Bore Type	Full Bore	Full Bore	Full Bore	Full Bore
22. Body Construction	split body, bolted	split body, bolted	split body, bolted	split body, bolted
23. Cladding or Coating	N/A	N/A	N/A	N/A
24. Valve Testing	FAT according A.9.3	FAT according A.9.3	FAT according A.9.3	FAT according A.9.3
25. Notes	N/A	N/A	N/A	N/A

Valve Code	VES-2510-2-S218	VES-2510-2-S219	VES-2510-2-S224	VES-2510-2-S228
Specs	H3	H3	H3	H3
1. Valve Type	Ball	Ball	Ball	Ball
2. Sealing Type	Soft	Soft	Soft	Soft
3. Valve Specification Level (VSL)	VSL-2	VSL-2	VSL-2	VSL-2
4. Ball Mouting	N/A	N/A	N/A	N/A
5. Standard	API 6D / IOGP S-562	API 6D / IOGP S-562	API 6D / IOGP S-562	API 6D / IOGP S-562
6. Size Range (NPS)	2" - 16"	2" - 16"	2" - 16"	2" - 16"
7. End Connection	ISO 27509, IX	ISO 27509, IX	ISO 27509, IX	ISO 27509, IX
8. Pressure Class	2500	2500	2500	2500
9. Temperature	-30°C to 120°C	-30°C to 120°C	0°C to 120°C	0°C to 120°C
10. Material Class	Stainless Steel	Stainless Steel	Stainless Steel	Stainless Steel
11. Body Material	ASTM A182 Gr F316	ASTM A182 Gr F316	ASTM A182 Gr F316	ASTM A182 Gr F316
12. Obturator Material	Duplex (UNS S31803)	Duplex (UNS S31803)	Duplex (UNS S31803)	Duplex (UNS S31803)
13. Seat Material	Duplex (UNS S31803)	Duplex (UNS S31803)	Duplex (UNS S31803)	Duplex (UNS S31803)
14. Seat Insert	PEEK	PEEK	PEEK	PEEK
15. Spring (Seat) Material	UNS N07750	UNS N07750	UNS N07750	UNS N07750
16. Stem Material	ASTM A276 (UNS S31803)	ASTM A276 (UNS S31803)	ASTM A276 (UNS S31803)	ASTM A276 (UNS S31803)
17. Seat-Stem Seal	Group B (acc. item A.7.1.5.6)	Group B (acc. item A.7.1.5.6)	Group C (acc. item A.7.1.5.6)	Group C (acc. item A.7.1.5.6)
18. Operator Type	Gearbox	Gearbox	Gearbox	Gearbox
19. Additional Requirement	N/A	Fire Tested (acc. item A.6.1.4)	N/A	N/A
20. Seat Type	Side A: SPE / Side B: DPE; DIB-2 & DBB	Side A: SPE / Side B: DPE; DIB-2 & DBB	Side A: SPE / Side B: SPE; DBB	Side A: SPE / Side B: DPE; DIB-2 & DBB
21. Bore Type	Full Bore	Full Bore	Full Bore	Full Bore
22. Body Construction	split body, bolted	split body, bolted	split body, bolted	split body, bolted
23. Cladding or Coating	N/A	N/A	N/A	N/A
24. Valve Testing	FAT according A.9.3	FAT according A.9.3	FAT according A.9.3	FAT according A.9.3
25. Notes	N/A	N/A	N/A	N/A

Valve Code	VES-2510-2-S234	VES-2510-2-S238	VES-2510-2-S250	VES-2510-2-S252
Specs	H3	H3	H3	H3
1. Valve Type	Ball	Ball	Ball	Ball
2. Sealing Type	Soft	Soft	Metal to Metal	Metal to Metal
3. Valve Specification Level (VSL)	VSL-2	VSL-2	VSL-2	VSL-2
4. Ball Mouting	N/A	N/A	N/A	N/A
5. Standard	API 6D / IOGP S-562	API 6D / IOGP S-562	API 6D / IOGP S-562	API 6D / IOGP S-562
6. Size Range (NPS)	2" - 16"	2" - 16"	2" - 16"	2" - 16"
7. End Connection	ISO 27509, IX	ISO 27509, IX	ISO 27509, IX	ISO 27509, IX
8. Pressure Class	2500	2500	2500	2500
9. Temperature	-46°C to 120°C	-46°C to 120°C	-30°C to 150°C	-30°C to 150°C
10. Material Class	Stainless Steel	Stainless Steel	Stainless Steel	Stainless Steel
11. Body Material	ASTM A182 Gr F316	ASTM A182 Gr F316	ASTM A182 Gr F316	ASTM A182 Gr F316
12. Obturator Material	Duplex (UNS S31803)	Duplex (UNS S31803)	AISI 316 + Tungsten carbide coating	AISI 316 + Tungsten carbide coating
13. Seat Material	Duplex (UNS S31803)	Duplex (UNS S31803)	AISI 316 + Tungsten carbide coating	AISI 316 + Tungsten carbide coating
14. Seat Insert	PEEK	PEEK	N/A	N/A
15. Spring (Seat) Material	UNS N07750	UNS N07750	UNS N07750	UNS N07750
16. Stem Material	ASTM A276 (UNS S31803)	ASTM A276 (UNS S31803)	ASTM A276 (UNS S31803)	ASTM A276 (UNS S31803)
17. Seat-Stem Seal	Group E (acc. item A.7.1.5.6)	Group E (acc. item A.7.1.5.6)	Group B (acc. item A.7.1.5.6)	Group B (acc. item A.7.1.5.6)
18. Operator Type	Gearbox	Gearbox	Gearbox	Gearbox
19. Additional Requirement	N/A	N/A	N/A	N/A
20. Seat Type	Side A: SPE / Side B: SPE; DBB	Side A: SPE / Side B: DPE; DIB-2 & DBB	Side A: SPE / Side B: SPE	Side A: SPE / Side B: DPE; DIB-2 & DBB
21. Bore Type	Full Bore	Full Bore	Full Bore	Full Bore
22. Body Construction	split body, bolted	split body, bolted	split body, bolted	split body, bolted
23. Cladding or Coating	N/A	N/A	N/A	N/A
24. Valve Testing	FAT according A.9.3	FAT according A.9.3	FAT according A.9.3	FAT according A.9.3
25. Notes	N/A	N/A	N/A	N/A

Valve Code	VES-2510-2-S260	VES-2510-2-S262	VES-2510-2-S270	VES-2510-2-S272
Specs	H3	H3	H3	H3
1. Valve Type	Ball	Ball	Ball	Ball
2. Sealing Type	Metal to Metal	Metal to Metal	Metal to Metal	Metal to Metal
3. Valve Specification Level (VSL)	VSL-2	VSL-2	VSL-2	VSL-2
4. Ball Mouting	N/A	N/A	N/A	N/A
5. Standard	API 6D	API 6D	API 6D	API 6D
6. Size Range (NPS)	2" - 16"	2" - 16"	2" - 16"	2" - 16"
7. End Connection	ISO 27509, IX	ISO 27509, IX	ISO 27509, IX	ISO 27509, IX
8. Pressure Class	2500	2500	2500	2500
9. Temperature	0°C to 210°C	0°C to 210°C	-100°C to 200°C	-100°C to 200°C
10. Material Class	Stainless Steel	Stainless Steel	Stainless Steel	Stainless Steel
11. Body Material	ASTM A182 Gr F316	ASTM A182 Gr F316	ASTM A182 Gr F316	ASTM A182 Gr F316
12. Obturator Material	AISI 316 + Tungsten carbide coating	AISI 316 + Tungsten carbide coating	AISI 316 + Tungsten carbide coating	AISI 316 + Tungsten carbide coating
13. Seat Material	AISI 316 + Tungsten carbide coating	AISI 316 + Tungsten carbide coating	AISI 316 + Tungsten carbide coating	AISI 316 + Tungsten carbide coating
14. Seat Insert	N/A	N/A	N/A	N/A
15. Spring (Seat) Material	UNS N07750	UNS N07750	UNS N07750	UNS N07750
16. Stem Material	ASTM A276 (UNS S31803)	ASTM A276 (UNS S31803)	ASTM B637 (UNS N07718)	ASTM B637 (UNS N07718)
17. Seat-Stem Seal	Group C (acc. item A.7.1.5.6)	Group C (acc. item A.7.1.5.6)	Group E (acc. item A.7.1.5.6)	Group E (acc. item A.7.1.5.6)
18. Operator Type	Gearbox	Gearbox	Gearbox	Gearbox
19. Additional Requirement	N/A	N/A	N/A	N/A
20. Seat Type	Side A: SPE / Side B: SPE	Side A: SPE / Side B: DPE; DIB-2 & DBB	Side A: SPE / Side B: SPE	Side A: SPE / Side B: DPE; DIB-2 & DBB
21. Bore Type	Full Bore	Full Bore	Full Bore	Full Bore
22. Body Construction	split body, bolted	split body, bolted	split body, bolted	split body, bolted
23. Cladding or Coating	N/A	N/A	N/A	N/A
24. Valve Testing	FAT according A.9.3	FAT according A.9.3	FAT according A.9.3	FAT according A.9.3
25. Notes	N/A	N/A	N/A	N/A

Valve Code	VES-2510-3-C152	VES-2510-3-C153	VES-2510-3-C162	VES-2510-3-C163
Specs	H10	H10	H10	H10
1. Valve Type	Ball	Ball	Ball	Ball
2. Sealing Type	Metal to Metal	Metal to Metal	Metal to Metal	Metal to Metal
3. Valve Specification Level (VSL)	VSL-3	VSL-3	VSL-3	VSL-3
4. Ball Mouting	N/A	N/A	N/A	N/A
5. Standard	API 6D / IOGP S-562	API 6D / IOGP S-562	API 6D	API 6D
6. Size Range (NPS)	2" - 20"	2" - 20"	2" - 20"	2" - 20"
7. End Connection	ISO 27509, IX	ISO 27509, IX	ISO 27509, IX	ISO 27509, IX
8. Pressure Class	2500	2500	2500	2500
9. Temperature	0°C to 150°C	-29°C to 150°C	0°C to 210°C	0°C to 210°C
10. Material Class	Carbon Steel	Carbon Steel	Carbon Steel	Carbon Steel
11. Body Material	ASTM A105 + SS316 weld overlay (acc. item A.7.1.7.3)	ASTM A105 + SS316 weld overlay (acc. item A.7.1.7.3)	ASTM A105 + SS316 weld overlay (acc. item A.7.1.7.3)	ASTM A105 + SS316 weld overlay (acc. item A.7.1.7.3)
12. Obturator Material	AISI 410 + Tungsten carbide coating	AISI 410 + Tungsten carbide coating	AISI 410 + Tungsten carbide coating	AISI 410 + Tungsten carbide coating
13. Seat Material	AISI 410 + Tungsten carbide coating	AISI 410 + Tungsten carbide coating	AISI 410 + Tungsten carbide coating	AISI 410 + Tungsten carbide coating
14. Seat Insert	N/A	N/A	N/A	N/A
15. Spring (Seat) Material	UNS N07750	UNS N07750	UNS N07750	UNS N07750
16. Stem Material	ASTM A276 (UNS S41000)	ASTM A276 (UNS S41000)	ASTM A276 (UNS S41000)	ASTM A276 (UNS S41000)
17. Seat-Stem Seal	Group A (acc. item A.7.1.5.6)	Group B (acc. item A.7.1.5.6)	Group C (acc. item A.7.1.5.6)	Group C (acc. item A.7.1.5.6)
18. Operator Type	Gearbox	Gearbox	Gearbox	Gearbox
19. Additional Requirement	N/A	Fire Tested (acc. item A.6.1.4)	N/A	Fire Tested (acc. item A.6.1.4)
20. Seat Type	Side A: SPE / Side B: DPE; DIB-2 & DBB	Side A: SPE / Side B: DPE; DIB-2 & DBB	Side A: SPE / Side B: DPE; DIB-2 & DBB	Side A: SPE / Side B: DPE; DIB-2 & DBB
21. Bore Type	Full Bore	Full Bore	Full Bore	Full Bore
22. Body Construction	split body, bolted	split body, bolted	split body, bolted	split body, bolted
23. Cladding or Coating	Partial clad - SS316 weld overlay on all body sealing areas	Partial clad - SS316 weld overlay on all body sealing areas	Partial clad - SS316 weld overlay on all body sealing areas	Partial clad - SS316 weld overlay on all body sealing areas
24. Valve Testing	FAT according A.9.3	FAT according A.9.3	FAT according A.9.3	FAT according A.9.3
25. Notes	Acceptance criteria for sealing tests see Annex A	Acceptance criteria for sealing tests see Annex A	Acceptance criteria for sealing tests see Annex A	Acceptance criteria for sealing tests see Annex A

Valve Code	VES-2510-3-C172	VES-2510-3-C173	VES-2510-3-C252	VES-2510-3-C253
Specs	H10	H10	H6	H6
1. Valve Type	Ball	Ball	Ball	Ball
2. Sealing Type	Metal to Metal	Metal to Metal	Metal to Metal	Metal to Metal
3. Valve Specification Level (VSL)	VSL-3	VSL-3	VSL-3	VSL-3
4. Ball Mouting	N/A	N/A	N/A	N/A
5. Standard	API 6D	API 6D	API 6D / IOGP S-562	API 6D / IOGP S-562
6. Size Range (NPS)	2" - 20"	2" - 20"	2" - 18"	2" - 18"
7. End Connection	ISO 27509, IX	ISO 27509, IX	ISO 27509, IX	ISO 27509, IX
8. Pressure Class	2500	2500	2500	2500
9. Temperature	0°C to 210°C	-29°C to 200°C	-30°C to 150°C	-30°C to 150°C
10. Material Class	Carbon Steel	Carbon Steel	Carbon Steel	Carbon Steel
11. Body Material	ASTM A105 + SS316 weld overlay (acc. item A.7.1.7.3)	ASTM A105 + SS316 weld overlay (acc. item A.7.1.7.3)	ASTM A350 Gr LF2 CL1 + Inconel 625 weld overlay (acc. item A.7.1.7.3)	ASTM A350 Gr LF2 CL1 + Inconel 625 weld overlay (acc. item A.7.1.7.3)
12. Obturator Material	AISI 410 + Tungsten carbide coating	AISI 410 + Tungsten carbide coating	AISI 316 + Tungsten carbide coating	AISI 316 + Tungsten carbide coating
13. Seat Material	AISI 410 + Tungsten carbide coating	AISI 410 + Tungsten carbide coating	AISI 316 + Tungsten carbide coating	AISI 316 + Tungsten carbide coating
14. Seat Insert	N/A	N/A	N/A	N/A
15. Spring (Seat) Material	UNS N07750	UNS N07750	UNS N07750	UNS N07750
16. Stem Material	ASTM A276 (UNS S41000)	ASTM A276 (UNS S41000)	ASTM B637 (UNS N07718)	ASTM B637 (UNS N07718)
17. Seat-Stem Seal	Group D (acc. item A.7.1.5.6)	Group E (acc. item A.7.1.5.6)	Group B (acc. item A.7.1.5.6)	Group B (acc. item A.7.1.5.6)
18. Operator Type	Gearbox	Gearbox	Gearbox	Gearbox
19. Additional Requirement	N/A	Fire Tested (acc. item A.6.1.4)	N/A	Fire Tested (acc. item A.6.1.4)
20. Seat Type	Side A: SPE / Side B: DPE; DIB-2 & DBB	Side A: SPE / Side B: DPE; DIB-2 & DBB	Side A: SPE / Side B: DPE; DIB-2 & DBB	Side A: SPE / Side B: DPE; DIB-2 & DBB
21. Bore Type	Full Bore	Full Bore	Full Bore	Full Bore
22. Body Construction	split body, bolted	split body, bolted	split body, bolted	split body, bolted
23. Cladding or Coating	Partial clad - SS316 weld overlay on all body sealing areas	Partial clad - SS316 weld overlay on all body sealing areas	Partial clad - Inconel 625 weld overlay on all body sealing areas	Partial clad - Inconel 625 weld overlay on all body sealing areas
24. Valve Testing	FAT according A.9.3	FAT according A.9.3	FAT according A.9.3	FAT according A.9.3
25. Notes	Acceptance criteria for sealing tests see Annex A	Acceptance criteria for sealing tests see Annex A	Acceptance criteria for sealing tests see Annex A	Acceptance criteria for sealing tests see Annex A

Valve Code	VES-2510-3-C272	VES-2510-3-C273	VES-2510-3-C572	VES-2510-3-C573
Specs	H6	H6	H30P H30	H30P H30
1. Valve Type	Ball	Ball	Ball	Ball
2. Sealing Type	Metal to Metal	Metal to Metal	Metal to Metal	Metal to Metal
3. Valve Specification Level (VSL)	VSL-3	VSL-3	VSL-3	VSL-3
4. Ball Mouting	N/A	N/A	N/A	N/A
5. Standard	API 6D	API 6D	API 6D	API 6D
6. Size Range (NPS)	2" - 18"	2" - 18"	2" - 24"	2" - 24"
7. End Connection	ISO 27509, IX	ISO 27509, IX	ISO 27509, IX	ISO 27509, IX
8. Pressure Class	2500	2500	2500	2500
9. Temperature	-46°C to 200°C	-46°C to 200°C	-29°C to 200°C	-29°C to 200°C
10. Material Class	Carbon Steel	Carbon Steel	Carbon Steel	Carbon Steel
11. Body Material	ASTM A350 Gr LF2 CL1 + Inconel 625 weld overlay (acc. item A.7.1.7.3)	ASTM A350 Gr LF2 CL1 + Inconel 625 weld overlay (acc. item A.7.1.7.3)	ASTM A105 + Inconel 625 weld overlay (acc. item A.7.1.7.3)	ASTM A105 + Inconel 625 weld overlay (acc. item A.7.1.7.3)
12. Obturator Material	AISI 316 + Tungsten carbide coating	AISI 316 + Tungsten carbide coating	ASTM A105 + Inconel 625 weld overlay (acc. item A.7.1.7.3) + Tungsten carbide coating	ASTM A105 + Inconel 625 weld overlay (acc. item A.7.1.7.3) + Tungsten carbide coating
13. Seat Material	AISI 316 + Tungsten carbide coating	AISI 316 + Tungsten carbide coating	ASTM A105 + Inconel 625 weld overlay (acc. item A.7.1.7.3) + Tungsten carbide coating	ASTM A105 + Inconel 625 weld overlay (acc. item A.7.1.7.3) + Tungsten carbide coating
14. Seat Insert	N/A	N/A	N/A	N/A
15. Spring (Seat) Material	UNS N07750	UNS N07750	UNS N07750	UNS N07750
16. Stem Material	ASTM B637 (UNS N07718)	ASTM B637 (UNS N07718)	ASTM B637 (UNS N07718)	ASTM B637 (UNS N07718)
17. Seat-Stem Seal	Group E (acc. item A.7.1.5.6)	Group E (acc. item A.7.1.5.6)	Group E (acc. item A.7.1.5.6)	Group E (acc. item A.7.1.5.6)
18. Operator Type	Gearbox	Gearbox	Gearbox	Gearbox
19. Additional Requirement	N/A	Fire Tested (acc. item A.6.1.4)	N/A	Fire Tested (acc. item A.6.1.4)
20. Seat Type	Side A: SPE / Side B: DPE; DIB-2 & DBB	Side A: SPE / Side B: DPE; DIB-2 & DBB	Side A: SPE / Side B: DPE; DIB-2 & DBB	Side A: SPE / Side B: DPE; DIB-2 & DBB
21. Bore Type	Full Bore	Full Bore	Full Bore	Full Bore
22. Body Construction	split body, bolted	split body, bolted	split body, bolted	split body, bolted
23. Cladding or Coating	Partial clad - Inconel 625 weld overlay on all body sealing areas	Partial clad - Inconel 625 weld overlay on all body sealing areas	Full clad - Inconel 625 weld overlay on all wetted parts	Full clad - Inconel 625 weld overlay on all wetted parts
24. Valve Testing	FAT according A.9.3	FAT according A.9.3	FAT according A.9.3	FAT according A.9.3
25. Notes	Acceptance criteria for sealing tests see Annex A	Acceptance criteria for sealing tests see Annex A	Acceptance criteria for sealing tests see Annex A	Acceptance criteria for sealing tests see Annex A

Valve Code	VES-2510-3-D352	VES-2510-3-D353	VES-2510-3-D372	VES-2510-3-D373
Specs	H12P H12	H12P H12	H12P H12	H12P H12
1. Valve Type	Ball	Ball	Ball	Ball
2. Sealing Type	Metal to Metal	Metal to Metal	Metal to Metal	Metal to Metal
3. Valve Specification Level (VSL)	VSL-3	VSL-3	VSL-3	VSL-3
4. Ball Mouting	N/A	N/A	N/A	N/A
5. Standard	API 6D / IOGP S-562	API 6D / IOGP S-562	API 6D	API 6D
6. Size Range (NPS)	2" - 18"	2" - 18"	2" - 18"	2" - 18"
7. End Connection	ISO 27509, IX	ISO 27509, IX	ISO 27509, IX	ISO 27509, IX
8. Pressure Class	2500	2500	2500	2500
9. Temperature	-30°C to 150°C	-30°C to 150°C	-50°C to 200°C	-50°C to 200°C
10. Material Class	Duplex Steel	Duplex Steel	Duplex Steel	Duplex Steel
11. Body Material	ASTM A182 Gr F55	ASTM A182 Gr F55	ASTM A182 Gr F55	ASTM A182 Gr F55
12. Obturator Material	Super Duplex (UNS S32760) + Tungsten carbide coating	Super Duplex (UNS S32760) + Tungsten carbide coating	Super Duplex (UNS S32760) + Tungsten carbide coating	Super Duplex (UNS S32760) + Tungsten carbide coating
13. Seat Material	Super Duplex (UNS S32760) + Tungsten carbide coating	Super Duplex (UNS S32760) + Tungsten carbide coating	Super Duplex (UNS S32760) + Tungsten carbide coating	Super Duplex (UNS S32760) + Tungsten carbide coating
14. Seat Insert	N/A	N/A	N/A	N/A
15. Spring (Seat) Material	UNS N07750	UNS N07750	UNS N07750	UNS N07750
16. Stem Material	ASTM A276 (UNS S32760)	ASTM A276 (UNS S32760)	ASTM A276 (UNS S32760)	ASTM A276 (UNS S32760)
17. Seat-Stem Seal	Group B (acc. item A.7.1.5.6)	Group B (acc. item A.7.1.5.6)	Group E (acc. item A.7.1.5.6)	Group E (acc. item A.7.1.5.6)
18. Operator Type	Gearbox	Gearbox	Gearbox	Gearbox
19. Additional Requirement	N/A	Fire Tested (acc. item A.6.1.4)	N/A	Fire Tested (acc. item A.6.1.4)
20. Seat Type	Side A: SPE / Side B: DPE; DIB-2 & DBB	Side A: SPE / Side B: DPE; DIB-2 & DBB	Side A: SPE / Side B: DPE; DIB-2 & DBB	Side A: SPE / Side B: DPE; DIB-2 & DBB
21. Bore Type	Full Bore	Full Bore	Full Bore	Full Bore
22. Body Construction	split body, bolted	split body, bolted	split body, bolted	split body, bolted
23. Cladding or Coating	N/A	N/A	N/A	N/A
24. Valve Testing	FAT according A.9.3	FAT according A.9.3	FAT according A.9.3	FAT according A.9.3
25. Notes	Acceptance criteria for sealing tests see Annex A	Acceptance criteria for sealing tests see Annex A	Acceptance criteria for sealing tests see Annex A	Acceptance criteria for sealing tests see Annex A

Valve Code	VES-2510-3-S252	VES-2510-3-S253	VES-2510-3-S262	VES-2510-3-S263
Specs	H3	H3	H3	H3
1. Valve Type	Ball	Ball	Ball	Ball
2. Sealing Type	Metal to Metal	Metal to Metal	Metal to Metal	Metal to Metal
3. Valve Specification Level (VSL)	VSL-3	VSL-3	VSL-3	VSL-3
4. Ball Mouting	N/A	N/A	N/A	N/A
5. Standard	API 6D / IOGP S-562	API 6D / IOGP S-562	API 6D	API 6D
6. Size Range (NPS)	2" - 16"	2" - 16"	2" - 16"	2" - 16"
7. End Connection	ISO 27509, IX	ISO 27509, IX	ISO 27509, IX	ISO 27509, IX
8. Pressure Class	2500	2500	2500	2500
9. Temperature	-30°C to 150°C	-30°C to 150°C	0°C to 210°C	0°C to 210°C
10. Material Class	Stainless Steel	Stainless Steel	Stainless Steel	Stainless Steel
11. Body Material	ASTM A182 Gr F316	ASTM A182 Gr F316	ASTM A182 Gr F316	ASTM A182 Gr F316
12. Obturator Material	AISI 316 + Tungsten carbide coating	AISI 316 + Tungsten carbide coating	AISI 316 + Tungsten carbide coating	AISI 316 + Tungsten carbide coating
13. Seat Material	AISI 316 + Tungsten carbide coating	AISI 316 + Tungsten carbide coating	AISI 316 + Tungsten carbide coating	AISI 316 + Tungsten carbide coating
14. Seat Insert	N/A	N/A	N/A	N/A
15. Spring (Seat) Material	UNS N07750	UNS N07750	UNS N07750	UNS N07750
16. Stem Material	ASTM A276 (UNS S31803)	ASTM B637 (UNS N07718)	ASTM A276 (UNS S31803)	ASTM B637 (UNS N07718)
17. Seat-Stem Seal	Group B (acc. item A.7.1.5.6)	Group B (acc. item A.7.1.5.6)	Group C (acc. item A.7.1.5.6)	Group C (acc. item A.7.1.5.6)
18. Operator Type	Gearbox	Gearbox	Gearbox	Gearbox
19. Additional Requirement	N/A	Fire Tested (acc. item A.6.1.4)	N/A	Fire Tested (acc. item A.6.1.4)
20. Seat Type	Side A: SPE / Side B: DPE; DIB-2 & DBB	Side A: SPE / Side B: DPE; DIB-2 & DBB	Side A: SPE / Side B: DPE; DIB-2 & DBB	Side A: SPE / Side B: DPE; DIB-2 & DBB
21. Bore Type	Full Bore	Full Bore	Full Bore	Full Bore
22. Body Construction	split body, bolted	split body, bolted	split body, bolted	split body, bolted
23. Cladding or Coating	N/A	N/A	N/A	N/A
24. Valve Testing	FAT according A.9.3	FAT according A.9.3	FAT according A.9.3	FAT according A.9.3
25. Notes	Acceptance criteria for sealing tests see Annex A	Acceptance criteria for sealing tests see Annex A	Acceptance criteria for sealing tests see Annex A	Acceptance criteria for sealing tests see Annex A

Valve Code	VES-2510-3-S272	VES-2510-3-S273	VES-2510-4-C574	VES-2510-4-C575
Specs	H3	H3	H30P H30	H30
1. Valve Type	Ball	Ball	Ball	Ball
2. Sealing Type	Metal to Metal	Metal to Metal	Metal to Metal	Metal to Metal
3. Valve Specification Level (VSL)	VSL-3	VSL-3	VSL-4	VSL-4
4. Ball Mouting	N/A	N/A	N/A	N/A
5. Standard	API 6D	API 6D	API 6D	API 6D
6. Size Range (NPS)	2" - 16"	2" - 16"	6" - 24"	6" - 24"
7. End Connection	ISO 27509, IX	ISO 27509, IX	ISO 27509, IX	ISO 27509, IX
8. Pressure Class	2500	2500	2500	2500
9. Temperature	-100°C to 200°C	-100°C to 200°C	-29°C to 200°C	-29°C to 200°C
10. Material Class	Stainless Steel	Stainless Steel	Carbon Steel	Carbon Steel
11. Body Material	ASTM A182 Gr F316	ASTM A182 Gr F316	ASTM A105 + Inconel 625 weld overlay (acc. item A.7.1.7.3)	ASTM A105 + Inconel 625 weld overlay (acc. item A.7.1.7.3)
12. Obturator Material	AISI 316 + Tungsten carbide coating	AISI 316 + Tungsten carbide coating	ASTM A105 + Inconel 625 weld overlay (acc. item A.7.1.7.3) + Tungsten carbide coating	ASTM A105 + Inconel 625 weld overlay (acc. item A.7.1.7.3) + Tungsten carbide coating
13. Seat Material	AISI 316 + Tungsten carbide coating	AISI 316 + Tungsten carbide coating	ASTM A105 + Inconel 625 weld overlay (acc. item A.7.1.7.3) + Tungsten carbide coating	ASTM A105 + Inconel 625 weld overlay (acc. item A.7.1.7.3) + Tungsten carbide coating
14. Seat Insert	N/A	N/A	N/A	N/A
15. Spring (Seat) Material	UNS N07750	UNS N07750	UNS N07750	UNS N07750
16. Stem Material	ASTM B637 (UNS N07718)	ASTM B637 (UNS N07718)	ASTM B637 (UNS N07718)	ASTM B637 (UNS N07718)
17. Seat-Stem Seal	Group E (acc. item A.7.1.5.6)	Group E (acc. item A.7.1.5.6)	Group E (acc. item A.7.1.5.6)	Group E (acc. item A.7.1.5.6)
18. Operator Type	Gearbox	Gearbox	Actuated	Actuated
19. Additional Requirement	N/A	Fire Tested (acc. item A.6.1.4)	Fire Tested (acc. item A.6.1.4)	Fire Tested (acc. item A.6.1.4); SIL-3 (see notes)
20. Seat Type	Side A: SPE / Side B: DPE; DIB-2 & DBB	Side A: SPE / Side B: DPE; DIB-2 & DBB	Side A: SPE / Side B: DPE; DIB-2 & DBB (notes)	Side A: SPE / Side B: DPE; DIB-2 & DBB (notes)
21. Bore Type	Full Bore	Full Bore	Full Bore	Full Bore
22. Body Construction	split body, bolted	split body, bolted	split body, bolted	split body, bolted
23. Cladding or Coating	N/A	N/A	Full clad - Inconel 625 weld overlay on all wetted parts	Full clad - Inconel 625 weld overlay on all wetted parts
24. Valve Testing	FAT according A.9.3	FAT according A.9.3	FAT according A.9.3	FAT according A.9.3 and HIPPS in place test according A.9.3.7
25. Notes	Acceptance criteria for sealing tests see Annex A	Acceptance criteria for sealing tests see Annex A	Acceptance criteria for sealing tests see Annex A, DBB tests to be performed at both conditions, fully opened and closed, Vent and drain connections according Annex A	Acceptance criteria for sealing tests see Annex A, DBB tests to be performed at both conditions, fully opened and closed, The manufacturer shall present all documentation in order to certify that SIL 3 requirements were achieved for the valve design, Vent and drain connections according Annex A

Valve Code	VES-2510-4-D354	VES-2510-4-D374	VES-2510-4-D375	VES-300-1-C110
Specs	H12P H12	H12P H12	H12	C9 C10 R9C S9C
1. Valve Type	Ball	Ball	Ball	Ball
2. Sealing Type	Metal to Metal	Metal to Metal	Metal to Metal	Soft
3. Valve Specification Level (VSL)	VSL-4	VSL-4	VSL-4	VSL-1
4. Ball Mouting	N/A	N/A	N/A	N/A
5. Standard	API 6D / IOGP S-562	API 6D	API 6D	API 6D / IOGP S-562
6. Size Range (NPS)	6" - 18"	6" - 18"	6" - 18"	2" - 32"
7. End Connection	ISO 27509, IX	ISO 27509, IX	ISO 27509, IX	2" - 24" ASME B16.5
	N/A	N/A	N/A	26" - 32" ASME B16.47 Series A
8. Pressure Class	2500	2500	2500	300
9. Temperature	-30°C to 150°C	-50°C to 200°C	-50°C to 200°C	-29°C to 150°C
10. Material Class	Duplex Steel	Duplex Steel	Duplex Steel	Carbon Steel
11. Body Material	ASTM A182 Gr F55	ASTM A182 Gr F55	ASTM A182 Gr F55	ASTM A105 or ASTM A216 Gr WCB + SS316 weld overlay (acc. item A.7.1.7.3)
12. Obturator Material	Super Duplex (UNS S32760) + Tungsten carbide coating	Super Duplex (UNS S32760) + Tungsten carbide coating	Super Duplex (UNS S32760) + Tungsten carbide coating	AISI 410
13. Seat Material	Super Duplex (UNS S32760) + Tungsten carbide coating	Super Duplex (UNS S32760) + Tungsten carbide coating	Super Duplex (UNS S32760) + Tungsten carbide coating	AISI 410
14. Seat Insert	N/A	N/A	N/A	PTFE reinforced with 25% Carbon
15. Spring (Seat) Material	UNS N07750	UNS N07750	UNS N07750	UNS N07750
16. Stem Material	ASTM A276 (UNS S32760)	ASTM A276 (UNS S32760)	ASTM A276 (UNS S32760)	ASTM A276 (UNS S41000)
17. Seat-Stem Seal	Group B (acc. item A.7.1.5.6)	Group E (acc. item A.7.1.5.6)	Group E (acc. item A.7.1.5.6)	Group B (acc. item A.7.1.5.6)
18. Operator Type	Actuated	Actuated	Actuated	N/A
19. Additional Requirement	Fire Tested (acc. item A.6.1.4)	Fire Tested (acc. item A.6.1.4)	Fire Tested (acc. item A.6.1.4); SIL-3 (see notes)	N/A
20. Seat Type	Side A: SPE / Side B: DPE; DIB-2 & DBB (notes)	Side A: SPE / Side B: DPE; DIB-2 & DBB (notes)	Side A: SPE / Side B: DPE; DIB-2 & DBB (notes)	Side A: SPE / Side B: SPE
21. Bore Type	Full Bore	Full Bore	Full Bore	Full Bore
22. Body Construction	split body, bolted	split body, bolted	split body, bolted	split body, bolted
23. Cladding or Coating	N/A	N/A	N/A	Partial clad - SS316 weld overlay on all body sealing areas
24. Valve Testing	FAT according A.9.3	FAT according A.9.3	FAT according A.9.3 and HIPPS in place test according A.9.3.7	FAT according A.9.3
25. Notes	Acceptance criteria for sealing tests see Annex A, DBB tests to be performed at both conditions, fully opened and closed, Vent and drain connections according Annex A	Acceptance criteria for sealing tests see Annex A, DBB tests to be performed at both conditions, fully opened and closed, Vent and drain connections according Annex A	Acceptance criteria for sealing tests see Annex A, DBB tests to be performed at both conditions, fully opened and closed, The manufacturer shall present all documentation in order to certify that SIL 3 requirements were achieved for the valve design, Vent and drain connections according Annex A	N/A

Valve Code	VES-300-1-C120		VES-300-1-C130		VES-300-1-C150		VES-300-1-C160	
Specs	C9 C10		C9 C10		C9 C10		C9 C10 S9C	
1. Valve Type	Ball		Ball		Ball		Ball	
2. Sealing Type	Soft		Soft		Metal to Metal		Metal to Metal	
3. Valve Specification Level (VSL)	VSL-1		VSL-1		VSL-1		VSL-1	
4. Ball Mouting	2" - 4"	Floating	2" - 4"	Floating	2" - 4"	Floating	2" - 4"	Floating
	6" - 32"	Trunnion	6" - 32"	Trunnion	6" - 32"	Trunnion	6" - 32"	Trunnion
5. Standard	API 6D / IOGP S-562		API 6D / IOGP S-562		API 6D / IOGP S-562		API 6D	
6. Size Range (NPS)	2" - 32"		2" - 32"		2" - 32"		2" - 32"	
7. End Connection	2" - 24"	ASME B16.5, RF	2" - 24"	ASME B16.5, RF	2" - 24"	ASME B16.5, RF	2" - 24"	ASME B16.5, RF
	26" - 32"	ASME B16.47 Series A, RF	26" - 32"	ASME B16.47 Series A, RF	26" - 32"	ASME B16.47 Series A, RF	26" - 32"	ASME B16.47 Series A, RF
8. Pressure Class	300		300		300		300	
9. Temperature	0°C to 150°C		0°C to 150°C		0°C to 150°C		0°C to 210°C	
10. Material Class	Carbon Steel		Carbon Steel		Carbon Steel		Carbon Steel	
11. Body Material	ASTM A105 or ASTM A216 Gr WCB + SS316 weld overlay (acc. item A.7.1.7.3)		ASTM A105 or ASTM A216 Gr WCB + SS316 weld overlay (acc. item A.7.1.7.3)		ASTM A105 or ASTM A216 Gr WCB + SS316 weld overlay (acc. item A.7.1.7.3)		ASTM A105 or ASTM A216 Gr WCB + SS316 weld overlay (acc. item A.7.1.7.3)	
12. Obturator Material	AISI 410		AISI 410		AISI 410 + Tungsten carbide coating		AISI 410 + Tungsten carbide coating	
13. Seat Material	AISI 410		AISI 410		AISI 410 + Tungsten carbide coating		AISI 410 + Tungsten carbide coating	
14. Seat Insert	PTFE reinforced with 25% Carbon		PTFE reinforced with 25% Carbon		N/A		N/A	
15. Spring (Seat) Material	UNS N07750		UNS N07750		UNS N07750		UNS N07750	
16. Stem Material	ASTM A276 (UNS S41000)		ASTM A276 (UNS S41000)		ASTM A276 (UNS S41000)		ASTM A276 (UNS S41000)	
17. Seat-Stem Seal	Group C (acc. item A.7.1.5.6)		Group D (acc. item A.7.1.5.6)		Group A (acc. item A.7.1.5.6)		Group C (acc. item A.7.1.5.6)	
18. Operator Type	2" - 4"	Lever	2" - 4"	Lever	2" - 4"	Lever	2" - 4"	Lever
	6" - 32"	Gearbox	6" - 32"	Gearbox	6" - 32"	Gearbox	6" - 32"	Gearbox
19. Additional Requirement	N/A		N/A		N/A		N/A	
20. Seat Type	Side A: SPE / Side B: SPE		Side A: SPE / Side B: SPE		Side A: SPE / Side B: SPE		Side A: SPE / Side B: SPE	
21. Bore Type	Full Bore		Full Bore		Full Bore		Full Bore	
22. Body Construction	split body, bolted		split body, bolted		split body, bolted		split body, bolted	
23. Cladding or Coating	Partial clad - SS316 weld overlay on all body sealing areas		Partial clad - SS316 weld overlay on all body sealing areas		Partial clad - SS316 weld overlay on all body sealing areas		Partial clad - SS316 weld overlay on all body sealing areas	
24. Valve Testing	FAT according A.9.3		FAT according A.9.3		FAT according A.9.3		FAT according A.9.3	
25. Notes	N/A		N/A		N/A		N/A	

Valve Code	VES-300-1-C170		VES-300-1-C180		VES-300-1-C210		VES-300-1-C230	
Specs	C9 C10		C9 C10		C6 C19		C6 C19	
1. Valve Type	Ball		Ball		Ball		Ball	
2. Sealing Type	Metal to Metal		Metal to Metal		Soft		Soft	
3. Valve Specification Level (VSL)	VSL-1		VSL-1		VSL-1		VSL-1	
4. Ball Mouting	2" - 4"	Floating	2" - 4"	Floating	2" - 4"	Floating	2" - 4"	Floating
	6" - 32"	Trunnion	6" - 32"	Trunnion	6" - 30"	Trunnion	6" - 30"	Trunnion
5. Standard	API 6D		API 6D		API 6D / IOGP S-562		API 6D / IOGP S-562	
6. Size Range (NPS)	2" - 32"		2" - 32"		2" - 30"		2" - 30"	
7. End Connection	2" - 24"	ASME B16.5, RF	2" - 24"	ASME B16.5, RF	2" - 24"	ASME B16.5, RF	2" - 24"	ASME B16.5, RF
	26" - 32"	ASME B16.47 Series A, RF	26" - 32"	ASME B16.47 Series A, RF	26" - 30"	ASME B16.47 Series A, RF	26" - 30"	ASME B16.47 Series A, RF
8. Pressure Class	300		300		300		300	
9. Temperature	0°C to 210°C		0°C to 400°C		-30°C to 150°C		-46°C to 150°C	
10. Material Class	Carbon Steel		Carbon Steel		Carbon Steel		Carbon Steel	
11. Body Material	ASTM A105 or ASTM A216 Gr WCB + SS316 weld overlay (acc. item A.7.1.7.3)		ASTM A105 or ASTM A216 Gr WCB + SS316 weld overlay (acc. item A.7.1.7.3)		ASTM A350 Gr LF2 CL1 or ASTM A352 Gr LCB + Inconel 625 weld overlay (acc. item A.7.1.7.3)		ASTM A350 Gr LF2 CL1 or ASTM A352 Gr LCB + Inconel 625 weld overlay (acc. item A.7.1.7.3)	
12. Obturator Material	AISI 410 + Tungsten carbide coating		AISI 410 + Chrome-Nickel Spray and Fuse (acc. Item A.8.2.2.4)		AISI 316		AISI 316	
13. Seat Material	AISI 410 + Tungsten carbide coating		AISI 410 + Chrome-Nickel Spray and Fuse (acc. Item A.8.2.2.4)		AISI 316		AISI 316	
14. Seat Insert	N/A		N/A		PTFE reinforced with 25% Carbon		PTFE reinforced with 25% Carbon	
15. Spring (Seat) Material	UNS N07750		UNS N07750		UNS N07750		UNS N07750	
16. Stem Material	ASTM A276 (UNS S41000)		ASTM A276 (UNS S41000)		ASTM A276 (UNS S31600)		ASTM A276 (UNS S31600)	
17. Seat-Stem Seal	Group D (acc. item A.7.1.5.6)		Group F (acc. item A.7.1.5.6)		Group B (acc. item A.7.1.5.6)		Group E (acc. item A.7.1.5.6)	
18. Operator Type	2" - 4"	Lever	2" - 4"	Lever	2" - 4"	Lever	2" - 4"	Lever
	6" - 32"	Gearbox	6" - 32"	Gearbox	6" - 30"	Gearbox	6" - 30"	Gearbox
19. Additional Requirement	N/A		N/A		N/A		N/A	
20. Seat Type	Side A: SPE / Side B: SPE		Side A: SPE / Side B: SPE		Side A: SPE / Side B: SPE		Side A: SPE / Side B: SPE	
21. Bore Type	Full Bore		Full Bore		Full Bore		Full Bore	
22. Body Construction	split body, bolted		split body, bolted		split body, bolted		split body, bolted	
23. Cladding or Coating	Partial clad - SS316 weld overlay on all body sealing areas		Partial clad - SS316 weld overlay on all body sealing areas		Partial clad - Inconel 625 weld overlay on all body sealing areas		Partial clad - Inconel 625 weld overlay on all body sealing areas	
24. Valve Testing	FAT according A.9.3		FAT according A.9.3		FAT according A.9.3		FAT according A.9.3	
25. Notes	N/A		N/A		N/A		N/A	

Valve Code	VES-300-1-C520		VES-300-1-C530		VES-300-1-C560		VES-300-1-C570	
Specs	C30		C30		C30		C30	
1. Valve Type	Ball		Ball		Ball		Ball	
2. Sealing Type	Soft		Soft		Metal to Metal		Metal to Metal	
3. Valve Specification Level (VSL)	VSL-1		VSL-1		VSL-1		VSL-1	
4. Ball Mouting	2" - 4"	Floating	2" - 4"	Floating	2" - 4"	Floating	2" - 4"	Floating
	6" - 26"	Trunnion	6" - 26"	Trunnion	6" - 26"	Trunnion	6" - 26"	Trunnion
5. Standard	API 6D / IOGP S-562		API 6D / IOGP S-562		API 6D		API 6D	
6. Size Range (NPS)	2" - 26"		2" - 26"		2" - 26"		2" - 26"	
7. End Connection	2" - 24"	ASME B16.5, RF	2" - 24"	ASME B16.5, RF	2" - 24"	ASME B16.5, RF	2" - 24"	ASME B16.5, RF
	26"	ASME B16.47 Series A, RF	26"	ASME B16.47 Series A, RF	26"	ASME B16.47 Series A, RF	26"	ASME B16.47 Series A, RF
8. Pressure Class	300		300		300		300	
9. Temperature	0°C to 150°C		0°C to 150°C		0°C to 210°C		0°C to 210°C	
10. Material Class	Carbon Steel		Carbon Steel		Carbon Steel		Carbon Steel	
11. Body Material	ASTM A105 or ASTM A216 Gr WCB + Inconel 625 weld overlay (acc. item A.7.1.7.3)		ASTM A105 or ASTM A216 Gr WCB + Inconel 625 weld overlay (acc. item A.7.1.7.3)		ASTM A105 or ASTM A216 Gr WCB + Inconel 625 weld overlay (acc. item A.7.1.7.3)		ASTM A105 or ASTM A216 Gr WCB + Inconel 625 weld overlay (acc. item A.7.1.7.3)	
12. Obturator Material	ASTM A105 + Inconel 625 weld overlay (acc. item A.7.1.7.3)		ASTM A105 + Inconel 625 weld overlay (acc. item A.7.1.7.3)		ASTM A105 + Inconel 625 weld overlay (acc. item A.7.1.7.3) + Tungsten carbide coating		ASTM A105 + Inconel 625 weld overlay (acc. item A.7.1.7.3) + Tungsten carbide coating	
13. Seat Material	ASTM A105 + Inconel 625 weld overlay (acc. item A.7.1.7.3)		ASTM A105 + Inconel 625 weld overlay (acc. item A.7.1.7.3)		ASTM A105 + Inconel 625 weld overlay (acc. item A.7.1.7.3) + Tungsten carbide coating		ASTM A105 + Inconel 625 weld overlay (acc. item A.7.1.7.3) + Tungsten carbide coating	
14. Seat Insert	PTFE reinforced with 25% Carbon		PTFE reinforced with 25% Carbon		N/A		N/A	
15. Spring (Seat) Material	UNS N07750		UNS N07750		UNS N07750		UNS N07750	
16. Stem Material	ASTM B637 (UNS N07718)		ASTM B637 (UNS N07718)		ASTM B637 (UNS N07718)		ASTM B637 (UNS N07718)	
17. Seat-Stem Seal	Group C (acc. item A.7.1.5.6)		Group D (acc. item A.7.1.5.6)		Group C (acc. item A.7.1.5.6)		Group D (acc. item A.7.1.5.6)	
18. Operator Type	2" - 4"	Lever	2" - 4"	Lever	2" - 4"	Lever	2" - 4"	Lever
	6" - 26"	Gearbox	6" - 26"	Gearbox	6" - 26"	Gearbox	6" - 26"	Gearbox
19. Additional Requirement	N/A		N/A		N/A		N/A	
20. Seat Type	Side A: SPE / Side B: SPE		Side A: SPE / Side B: SPE		Side A: SPE / Side B: SPE		Side A: SPE / Side B: SPE	
21. Bore Type	Full Bore		Full Bore		Full Bore		Full Bore	
22. Body Construction	split body, bolted		split body, bolted		split body, bolted		split body, bolted	
23. Cladding or Coating	Full clad - Inconel 625 weld overlay on all wetted parts		Full clad - Inconel 625 weld overlay on all wetted parts		Full clad - Inconel 625 weld overlay on all wetted parts		Full clad - Inconel 625 weld overlay on all wetted parts	
24. Valve Testing	FAT according A.9.3		FAT according A.9.3		FAT according A.9.3		FAT according A.9.3	
25. Notes	N/A		N/A		N/A		N/A	

Valve Code	VES-300-1-D200	VES-300-1-D210	VES-300-1-D220	VES-300-1-D230
Specs	C11	C11 C16	C16	C16
1. Valve Type	Ball	Ball	Ball	Ball
2. Sealing Type	Soft	Soft	Soft	Soft
3. Valve Specification Level (VSL)	VSL-1	VSL-1	VSL-1	VSL-1
4. Ball Mouting	Floating	N/A	N/A	N/A
5. Standard	API 6D	API 6D / IOGP S-562	API 6D / IOGP S-562	API 6D / IOGP S-562
6. Size Range (NPS)	1" - 1 ½"	2" - 24"	2" - 24"	2" - 24"
7. End Connection	Flange ASME B16.5, RF	N/A	N/A	N/A
8. Pressure Class	300	300	300	300
9. Temperature	0°C to 150°C	-30°C to 150°C	0°C to 150°C	-46°C to 150°C
10. Material Class	Duplex Steel	Duplex Steel	Duplex Steel	Duplex Steel
11. Body Material	ASTM A182 Gr F51	ASTM A182 Gr F51 or ASTM A995 Gr 4a	ASTM A182 Gr F51 or ASTM A995 Gr 4a	ASTM A182 Gr F51 or ASTM A995 Gr 4a
12. Obturator Material	Duplex (UNS S31803)	Duplex (UNS S31803)	Duplex (UNS S31803)	Duplex (UNS S31803)
13. Seat Material	PTFE reinforced with 25% Carbon	Duplex (UNS S31803)	Duplex (UNS S31803)	Duplex (UNS S31803)
14. Seat Insert	N/A	PTFE reinforced with 25% Carbon	PTFE reinforced with 25% Carbon	PTFE reinforced with 25% Carbon
15. Spring (Seat) Material	N/A	UNS N07750	UNS N07750	UNS N07750
16. Stem Material	ASTM A276 (UNS S31803)	ASTM A276 (UNS S31803)	ASTM A276 (UNS S31803)	ASTM A276 (UNS S31803)
17. Seat-Stem Seal	Group A (acc. item A.7.1.5.6)	Group B (acc. item A.7.1.5.6)	Group C (acc. item A.7.1.5.6)	Group E (acc. item A.7.1.5.6)
18. Operator Type	Lever	N/A	N/A	N/A
19. Additional Requirement	Fire Tested (acc. item A.6.1.4)	N/A	N/A	N/A
20. Seat Type	N/A	Side A: SPE / Side B: SPE	Side A: SPE / Side B: SPE	Side A: SPE / Side B: SPE
21. Bore Type	Full Bore	Full Bore	Full Bore	Full Bore
22. Body Construction	split body, bolted	split body, bolted	split body, bolted	split body, bolted
23. Cladding or Coating	N/A	N/A	N/A	N/A
24. Valve Testing	FAT according A.9.3	FAT according A.9.3	FAT according A.9.3	FAT according A.9.3
25. Notes	N/A	N/A	N/A	N/A

**OFFSHORE PRODUCTION FACILITIES
PIPING SPECIFICATION FOR TOPSIDE**

Valve Code	VES-300-1-D250		VES-300-1-D260		VES-300-1-D270		VES-300-1-D310	
Specs	C16		C16		C16		C12	
1. Valve Type	Ball		Ball		Ball		Ball	
2. Sealing Type	Metal to Metal		Metal to Metal		Metal to Metal		Soft	
3. Valve Specification Level (VSL)	VSL-1		VSL-1		VSL-1		VSL-1	
4. Ball Mouting	2" - 4"	Floating	2" - 4"	Floating	2" - 4"	Floating	2" - 4"	Floating
	6" - 24"	Trunnion	6" - 24"	Trunnion	6" - 24"	Trunnion	6" - 30"	Trunnion
5. Standard	API 6D / IOGP S-562		API 6D / IOGP S-562		API 6D / IOGP S-562		API 6D / IOGP S-562	
6. Size Range (NPS)	2" - 24"		2" - 24"		2" - 24"		2" - 30"	
7. End Connection	ASME B16.5, RF		ASME B16.5, RF		ASME B16.5, RF		2" - 24"	ASME B16.5, RF
	N/A		N/A		N/A		26" - 30"	ASME B16.47 Series A, RF
8. Pressure Class	300		300		300		300	
9. Temperature	-30°C to 150°C		0°C to 150°C		-46°C to 150°C		-30°C to 150°C	
10. Material Class	Duplex Steel		Duplex Steel		Duplex Steel		Duplex Steel	
11. Body Material	ASTM A182 Gr F51 or ASTM A995 Gr 4a		ASTM A182 Gr F51 or ASTM A995 Gr 4a		ASTM A182 Gr F51 or ASTM A995 Gr 4a		ASTM A182 Gr F55 or ASTM A995 Gr 6a	
12. Obturator Material	Duplex (UNS S31803) + Tungsten carbide coating		Duplex (UNS S31803) + Tungsten carbide coating		Duplex (UNS S31803) + Tungsten carbide coating		Super Duplex (UNS S32760)	
13. Seat Material	Duplex (UNS S31803) + Tungsten carbide coating		Duplex (UNS S31803) + Tungsten carbide coating		Duplex (UNS S31803) + Tungsten carbide coating		Super Duplex (UNS S32760)	
14. Seat Insert	N/A		N/A		N/A		PTFE reinforced with 25% Carbon	
15. Spring (Seat) Material	UNS N07750		UNS N07750		UNS N07750		UNS N07750	
16. Stem Material	ASTM A276 (UNS S31803)		ASTM A276 (UNS S31803)		ASTM A276 (UNS S31803)		ASTM A276 (UNS S32760)	
17. Seat-Stem Seal	Group B (acc. item A.7.1.5.6)		Group C (acc. item A.7.1.5.6)		Group E (acc. item A.7.1.5.6)		Group B (acc. item A.7.1.5.6)	
18. Operator Type	2" - 4"	Lever	2" - 4"	Lever	2" - 4"	Lever	2" - 4"	Lever
	6" - 24"	Gearbox	6" - 24"	Gearbox	6" - 24"	Gearbox	6" - 30"	Gearbox
19. Additional Requirement	N/A		N/A		N/A		N/A	
20. Seat Type	Side A: SPE / Side B: SPE		Side A: SPE / Side B: SPE		Side A: SPE / Side B: SPE		Side A: SPE / Side B: SPE	
21. Bore Type	Full Bore		Full Bore		Full Bore		Full Bore	
22. Body Construction	split body, bolted		split body, bolted		split body, bolted		split body, bolted	
23. Cladding or Coating	N/A		N/A		N/A		N/A	
24. Valve Testing	FAT according A.9.3		FAT according A.9.3		FAT according A.9.3		FAT according A.9.3	
25. Notes	N/A		N/A		N/A		N/A	

Valve Code	VES-300-1-D330		VES-300-1-S210		VES-300-1-S220		VES-300-1-S230	
Specs	C12		C3 R3C S3C		C3		C3	
1. Valve Type	Ball		Ball		Ball		Ball	
2. Sealing Type	Soft		Soft		Soft		Soft	
3. Valve Specification Level (VSL)	VSL-1		VSL-1		VSL-1		VSL-1	
4. Ball Mouting	2" - 4"	Floating	2" - 4"	Floating	2" - 4"	Floating	2" - 4"	Floating
	6" - 30"	Trunnion	6" - 30"	Trunnion	6" - 30"	Trunnion	6" - 30"	Trunnion
5. Standard	API 6D / IOGP S-562		API 6D / IOGP S-562		API 6D / IOGP S-562		API 6D / IOGP S-562	
6. Size Range (NPS)	2" - 30"		2" - 30"		2" - 30"		2" - 30"	
7. End Connection	2" - 24"	ASME B16.5, RF	2" - 24"	ASME B16.5, RF	2" - 24"	ASME B16.5, RF	2" - 24"	ASME B16.5, RF
	26" - 30"	ASME B16.47 Series A, RF	26" - 30"	ASME B16.47 Series A, RF	26" - 30"	ASME B16.47 Series A, RF	26" - 30"	ASME B16.47 Series A, RF
8. Pressure Class	300		300		300		300	
9. Temperature	0°C to 150°C		-30°C to 150°C		0°C to 150°C		-46°C to 150°C	
10. Material Class	Duplex Steel		Stainless Steel		Stainless Steel		Stainless Steel	
11. Body Material	ASTM A182 Gr F55 or ASTM A995 Gr 6a		ASTM A182 Gr F316 or ASTM A351 Gr CF8M		ASTM A182 Gr F316 or ASTM A351 Gr CF8M		ASTM A182 Gr F316 or ASTM A351 Gr CF8M	
12. Obturator Material	Super Duplex (UNS S32760)		AISI 316		AISI 316		AISI 316	
13. Seat Material	Super Duplex (UNS S32760)		AISI 316		AISI 316		AISI 316	
14. Seat Insert	PTFE reinforced with 25% Carbon		PTFE reinforced with 25% Carbon		PTFE reinforced with 25% Carbon		PTFE reinforced with 25% Carbon	
15. Spring (Seat) Material	UNS N07750		UNS N07750		UNS N07750		UNS N07750	
16. Stem Material	ASTM A276 (UNS S32760)		ASTM A276 (UNS S31600)		ASTM A276 (UNS S31600)		ASTM A276 (UNS S31600)	
17. Seat-Stem Seal	Group D (acc. item A.7.1.5.6)		Group B (acc. item A.7.1.5.6)		Group C (acc. item A.7.1.5.6)		Group E (acc. item A.7.1.5.6)	
18. Operator Type	2" - 4"	Lever	2" - 4"	Lever	2" - 4"	Lever	2" - 4"	Lever
	6" - 30"	Gearbox	6" - 30"	Gearbox	6" - 30"	Gearbox	6" - 30"	Gearbox
19. Additional Requirement	N/A		N/A		N/A		N/A	
20. Seat Type	Side A: SPE / Side B: SPE		Side A: SPE / Side B: SPE		Side A: SPE / Side B: SPE		Side A: SPE / Side B: SPE	
21. Bore Type	Full Bore		Full Bore		Full Bore		Full Bore	
22. Body Construction	split body, bolted		split body, bolted		split body, bolted		split body, bolted	
23. Cladding or Coating	N/A		N/A		N/A		N/A	
24. Valve Testing	FAT according A.9.3		FAT according A.9.3		FAT according A.9.3		FAT according A.9.3	
25. Notes	N/A		N/A		N/A		N/A	

Valve Code	VES-300-2-C110		VES-300-2-C116		VES-300-2-C120		VES-300-2-C126	
Specs	C9 C10 S9C		C9 C10		C9 C10		C9 C10	
1. Valve Type	Ball		Ball		Ball		Ball	
2. Sealing Type	Soft		Soft		Soft		Soft	
3. Valve Specification Level (VSL)	VSL-2		VSL-2		VSL-2		VSL-2	
4. Ball Mouting	2" - 4"	Floating	2" - 4"	Floating	2" - 4"	Floating	2" - 4"	Floating
	6" - 32"	Trunnion	6" - 32"	Trunnion	6" - 32"	Trunnion	6" - 32"	Trunnion
5. Standard	API 6D / IOGP S-562		API 6D / IOGP S-562		API 6D / IOGP S-562		API 6D / IOGP S-562	
6. Size Range (NPS)	2" - 32"		2" - 32"		2" - 32"		2" - 32"	
7. End Connection	2" - 24"	ASME B16.5, RF	2" - 24"	ASME B16.5, RF	2" - 24"	ASME B16.5, RF	2" - 24"	ASME B16.5, RF
	26" - 32"	ASME B16.47 Series A, RF	26" - 32"	ASME B16.47 Series A, RF	26" - 32"	ASME B16.47 Series A, RF	26" - 32"	ASME B16.47 Series A, RF
8. Pressure Class	300		300		300		300	
9. Temperature	-29°C to 150°C		-29°C to 150°C		0°C to 150°C		0°C to 150°C	
10. Material Class	Carbon Steel		Carbon Steel		Carbon Steel		Carbon Steel	
11. Body Material	ASTM A105 or ASTM A216 Gr WCB + SS316 weld overlay (acc. item A.7.1.7.3)		ASTM A105 or ASTM A216 Gr WCB + SS316 weld overlay (acc. item A.7.1.7.3)		ASTM A105 or ASTM A216 Gr WCB + SS316 weld overlay (acc. item A.7.1.7.3)		ASTM A105 or ASTM A216 Gr WCB + SS316 weld overlay (acc. item A.7.1.7.3)	
12. Obturator Material	AISI 410		AISI 410		AISI 410		AISI 410	
13. Seat Material	AISI 410		AISI 410		AISI 410		AISI 410	
14. Seat Insert	PTFE reinforced with 25% Carbon		PTFE reinforced with 25% Carbon		PTFE reinforced with 25% Carbon		PTFE reinforced with 25% Carbon	
15. Spring (Seat) Material	UNS N07750		UNS N07750		UNS N07750		UNS N07750	
16. Stem Material	ASTM A276 (UNS S41000)		ASTM A276 (UNS S41000)		ASTM A276 (UNS S41000)		ASTM A276 (UNS S41000)	
17. Seat-Stem Seal	Group B (acc. item A.7.1.5.6)		Group B (acc. item A.7.1.5.6)		Group C (acc. item A.7.1.5.6)		Group C (acc. item A.7.1.5.6)	
18. Operator Type	2" - 4"	Lever	2" - 4"	Lever	2" - 4"	Lever	2" - 4"	Lever
	6" - 32"	Gearbox	6" - 32"	Gearbox	6" - 32"	Gearbox	6" - 32"	Gearbox
19. Additional Requirement	N/A		N/A		N/A		N/A	
20. Seat Type	Side A: SPE / Side B: SPE		Side A: SPE / Side B: DPE; DIB-2 & DBB		Side A: SPE / Side B: SPE		Side A: SPE / Side B: DPE; DIB-2 & DBB	
21. Bore Type	Full Bore		Full Bore		Full Bore		Full Bore	
22. Body Construction	split body, bolted		split body, bolted		split body, bolted		split body, bolted	
23. Cladding or Coating	Partial clad - SS316 weld overlay on all body sealing areas		Partial clad - SS316 weld overlay on all body sealing areas		Partial clad - SS316 weld overlay on all body sealing areas		Partial clad - SS316 weld overlay on all body sealing areas	
24. Valve Testing	FAT according A.9.3		FAT according A.9.3		FAT according A.9.3		FAT according A.9.3	
25. Notes	N/A		N/A		N/A		N/A	

Valve Code	VES-300-2-C130		VES-300-2-C136		VES-300-2-C150		VES-300-2-C152	
Specs	C9 C10		C9 C10		C9 C10		C9 C10	
1. Valve Type	Ball		Ball		Ball		Ball	
2. Sealing Type	Soft		Soft		Metal to Metal		Metal to Metal	
3. Valve Specification Level (VSL)	VSL-2		VSL-2		VSL-2		VSL-2	
4. Ball Mouting	2" - 4"	Floating	2" - 4"	Floating	2" - 4"	Floating	2" - 4"	Floating
	6" - 32"	Trunnion	6" - 32"	Trunnion	6" - 32"	Trunnion	6" - 32"	Trunnion
5. Standard	API 6D / IOGP S-562		API 6D / IOGP S-562		API 6D / IOGP S-562		API 6D / IOGP S-562	
6. Size Range (NPS)	2" - 32"		2" - 32"		2" - 32"		2" - 32"	
7. End Connection	2" - 24"	ASME B16.5, RF	2" - 24"	ASME B16.5, RF	2" - 24"	ASME B16.5, RF	2" - 24"	ASME B16.5, RF
	26" - 32"	ASME B16.47 Series A, RF	26" - 32"	ASME B16.47 Series A, RF	26" - 32"	ASME B16.47 Series A, RF	26" - 32"	ASME B16.47 Series A, RF
8. Pressure Class	300		300		300		300	
9. Temperature	0°C to 150°C		0°C to 150°C		0°C to 150°C		-29°C to 150°C	
10. Material Class	Carbon Steel		Carbon Steel		Carbon Steel		Carbon Steel	
11. Body Material	ASTM A105 or ASTM A216 Gr WCB + SS316 weld overlay (acc. item A.7.1.7.3)		ASTM A105 or ASTM A216 Gr WCB + SS316 weld overlay (acc. item A.7.1.7.3)		ASTM A105 or ASTM A216 Gr WCB + SS316 weld overlay (acc. item A.7.1.7.3)		ASTM A105 or ASTM A216 Gr WCB + SS316 weld overlay (acc. item A.7.1.7.3)	
12. Obturator Material	AISI 410		AISI 410		AISI 410 + Tungsten carbide coating		AISI 410 + Tungsten carbide coating	
13. Seat Material	AISI 410		AISI 410		AISI 410 + Tungsten carbide coating		AISI 410 + Tungsten carbide coating	
14. Seat Insert	PTFE reinforced with 25% Carbon		PTFE reinforced with 25% Carbon		N/A		N/A	
15. Spring (Seat) Material	UNS N07750		UNS N07750		UNS N07750		UNS N07750	
16. Stem Material	ASTM A276 (UNS S41000)		ASTM A276 (UNS S41000)		ASTM A276 (UNS S41000)		ASTM A276 (UNS S41000)	
17. Seat-Stem Seal	Group D (acc. item A.7.1.5.6)		Group D (acc. item A.7.1.5.6)		Group A (acc. item A.7.1.5.6)		Group B (acc. item A.7.1.5.6)	
18. Operator Type	2" - 4"	Lever	2" - 4"	Lever	2" - 4"	Lever	2" - 4"	Lever
	6" - 32"	Gearbox	6" - 32"	Gearbox	6" - 32"	Gearbox	6" - 32"	Gearbox
19. Additional Requirement	N/A		N/A		N/A		N/A	
20. Seat Type	Side A: SPE / Side B: SPE		Side A: SPE / Side B: DPE; DIB-2 & DBB		Side A: SPE / Side B: SPE		Side A: SPE / Side B: DPE; DIB-2 & DBB	
21. Bore Type	Full Bore		Full Bore		Full Bore		Full Bore	
22. Body Construction	split body, bolted		split body, bolted		split body, bolted		split body, bolted	
23. Cladding or Coating	Partial clad - SS316 weld overlay on all body sealing areas		Partial clad - SS316 weld overlay on all body sealing areas		Partial clad - SS316 weld overlay on all body sealing areas		Partial clad - SS316 weld overlay on all body sealing areas	
24. Valve Testing	FAT according A.9.3		FAT according A.9.3		FAT according A.9.3		FAT according A.9.3	
25. Notes	N/A		N/A		N/A		N/A	

Valve Code	VES-300-2-C160		VES-300-2-C162		VES-300-2-C170		VES-300-2-C172	
Specs	C9 C10 S9C		C9 C10		C9 C10		C9 C10	
1. Valve Type	Ball		Ball		Ball		Ball	
2. Sealing Type	Metal to Metal		Metal to Metal		Metal to Metal		Metal to Metal	
3. Valve Specification Level (VSL)	VSL-2		VSL-2		VSL-2		VSL-2	
4. Ball Mouting	2" - 4"	Floating	2" - 4"	Floating	2" - 4"	Floating	2" - 4"	Floating
	6" - 32"	Trunnion	6" - 32"	Trunnion	6" - 32"	Trunnion	6" - 32"	Trunnion
5. Standard	API 6D		API 6D		API 6D		API 6D	
6. Size Range (NPS)	2" - 32"		2" - 32"		2" - 32"		2" - 32"	
7. End Connection	2" - 24"	ASME B16.5, RF	2" - 24"	ASME B16.5, RF	2" - 24"	ASME B16.5, RF	2" - 24"	ASME B16.5, RF
	26" - 32"	ASME B16.47 Series A, RF	26" - 32"	ASME B16.47 Series A, RF	26" - 32"	ASME B16.47 Series A, RF	26" - 32"	ASME B16.47 Series A, RF
8. Pressure Class	300		300		300		300	
9. Temperature	0°C to 210°C		0°C to 210°C		0°C to 210°C		0°C to 210°C	
10. Material Class	Carbon Steel		Carbon Steel		Carbon Steel		Carbon Steel	
11. Body Material	ASTM A105 or ASTM A216 Gr WCB + SS316 weld overlay (acc. item A.7.1.7.3)		ASTM A105 or ASTM A216 Gr WCB + SS316 weld overlay (acc. item A.7.1.7.3)		ASTM A105 or ASTM A216 Gr WCB + SS316 weld overlay (acc. item A.7.1.7.3)		ASTM A105 or ASTM A216 Gr WCB + SS316 weld overlay (acc. item A.7.1.7.3)	
12. Obturator Material	AISI 410 + Tungsten carbide coating		AISI 410 + Tungsten carbide coating		AISI 410 + Tungsten carbide coating		AISI 410 + Tungsten carbide coating	
13. Seat Material	AISI 410 + Tungsten carbide coating		AISI 410 + Tungsten carbide coating		AISI 410 + Tungsten carbide coating		AISI 410 + Tungsten carbide coating	
14. Seat Insert	N/A		N/A		N/A		N/A	
15. Spring (Seat) Material	UNS N07750		UNS N07750		UNS N07750		UNS N07750	
16. Stem Material	ASTM A276 (UNS S41000)		ASTM A276 (UNS S41000)		ASTM A276 (UNS S41000)		ASTM A276 (UNS S41000)	
17. Seat-Stem Seal	Group C (acc. item A.7.1.5.6)		Group C (acc. item A.7.1.5.6)		Group D (acc. item A.7.1.5.6)		Group D (acc. item A.7.1.5.6)	
18. Operator Type	2" - 4"	Lever	2" - 4"	Lever	2" - 4"	Lever	2" - 4"	Lever
	6" - 32"	Gearbox	6" - 32"	Gearbox	6" - 32"	Gearbox	6" - 32"	Gearbox
19. Additional Requirement	N/A		N/A		N/A		N/A	
20. Seat Type	Side A: SPE / Side B: SPE		Side A: SPE / Side B: DPE; DIB-2 & DBB		Side A: SPE / Side B: SPE		Side A: SPE / Side B: DPE; DIB-2 & DBB	
21. Bore Type	Full Bore		Full Bore		Full Bore		Full Bore	
22. Body Construction	split body, bolted		split body, bolted		split body, bolted		split body, bolted	
23. Cladding or Coating	Partial clad - SS316 weld overlay on all body sealing areas		Partial clad - SS316 weld overlay on all body sealing areas		Partial clad - SS316 weld overlay on all body sealing areas		Partial clad - SS316 weld overlay on all body sealing areas	
24. Valve Testing	FAT according A.9.3		FAT according A.9.3		FAT according A.9.3		FAT according A.9.3	
25. Notes	N/A		N/A		N/A		N/A	

Valve Code	VES-300-2-C180		VES-300-2-C182		VES-300-2-C210		VES-300-2-C216	
Specs	C9 C10		C9 C10		C6 C19		C6 C19	
1. Valve Type	Ball		Ball		Ball		Ball	
2. Sealing Type	Metal to Metal		Metal to Metal		Soft		Soft	
3. Valve Specification Level (VSL)	VSL-2		VSL-2		VSL-2		VSL-2	
4. Ball Mouting	2" - 4"	Floating	2" - 4"	Floating	2" - 4"	Floating	2" - 4"	Floating
	6" - 32"	Trunnion	6" - 32"	Trunnion	6" - 30"	Trunnion	6" - 30"	Trunnion
5. Standard	API 6D		API 6D		API 6D / IOGP S-562		API 6D / IOGP S-562	
6. Size Range (NPS)	2" - 32"		2" - 32"		2" - 30"		2" - 30"	
7. End Connection	2" - 24"	ASME B16.5, RF	2" - 24"	ASME B16.5, RF	2" - 24"	ASME B16.5, RF	2" - 24"	ASME B16.5, RF
	26" - 32"	ASME B16.47 Series A, RF	26" - 32"	ASME B16.47 Series A, RF	26" - 30"	ASME B16.47 Series A, RF	26" - 30"	ASME B16.47 Series A, RF
8. Pressure Class	300		300		300		300	
9. Temperature	0°C to 400°C		0°C to 400°C		-30°C to 150°C		-30°C to 150°C	
10. Material Class	Carbon Steel		Carbon Steel		Carbon Steel		Carbon Steel	
11. Body Material	ASTM A105 or ASTM A216 Gr WCB + SS316 weld overlay (acc. item A.7.1.7.3)		ASTM A105 or ASTM A216 Gr WCB + SS316 weld overlay (acc. item A.7.1.7.3)		ASTM A350 Gr LF2 CL1 or ASTM A352 Gr LCB + Inconel 625 weld overlay (acc. item A.7.1.7.3)		ASTM A350 Gr LF2 CL1 or ASTM A352 Gr LCB + Inconel 625 weld overlay (acc. item A.7.1.7.3)	
12. Obturator Material	AISI 410 + Chrome-Nickel Spray and Fuse (acc. Item A.8.2.2.4)		AISI 410 + Chrome-Nickel Spray and Fuse (acc. Item A.8.2.2.4)		AISI 316		AISI 316	
13. Seat Material	AISI 410 + Chrome-Nickel Spray and Fuse (acc. Item A.8.2.2.4)		AISI 410 + Chrome-Nickel Spray and Fuse (acc. Item A.8.2.2.4)		AISI 316		AISI 316	
14. Seat Insert	N/A		N/A		PTFE reinforced with 25% Carbon		PTFE reinforced with 25% Carbon	
15. Spring (Seat) Material	UNS N07750		UNS N07750		UNS N07750		UNS N07750	
16. Stem Material	ASTM A276 (UNS S41000)		ASTM A276 (UNS S41000)		ASTM A276 (UNS S31600)		ASTM A276 (UNS S31600)	
17. Seat-Stem Seal	Group F (acc. item A.7.1.5.6)		Group F (acc. item A.7.1.5.6)		Group B (acc. item A.7.1.5.6)		Group B (acc. item A.7.1.5.6)	
18. Operator Type	2" - 4"	Lever	2" - 4"	Lever	2" - 4"	Lever	2" - 4"	Lever
	6" - 32"	Gearbox	6" - 32"	Gearbox	6" - 30"	Gearbox	6" - 30"	Gearbox
19. Additional Requirement	N/A		N/A		N/A		N/A	
20. Seat Type	Side A: SPE / Side B: SPE		Side A: SPE / Side B: DPE; DIB-2 & DBB		Side A: SPE / Side B: SPE		Side A: SPE / Side B: DPE; DIB-2 & DBB	
21. Bore Type	Full Bore		Full Bore		Full Bore		Full Bore	
22. Body Construction	split body, bolted		split body, bolted		split body, bolted		split body, bolted	
23. Cladding or Coating	Partial clad - SS316 weld overlay on all body sealing areas		Partial clad - SS316 weld overlay on all body sealing areas		Partial clad - Inconel 625 weld overlay on all body sealing areas		Partial clad - Inconel 625 weld overlay on all body sealing areas	
24. Valve Testing	FAT according A.9.3		FAT according A.9.3		FAT according A.9.3		FAT according A.9.3	
25. Notes	N/A		N/A		N/A		N/A	

Valve Code	VES-300-2-C230		VES-300-2-C236		VES-300-2-C270		VES-300-2-C510	
Specs	C6 C19		C6 C19		C19		C30	
1. Valve Type	Ball		Ball		Ball		Ball	
2. Sealing Type	Soft		Soft		Metal to Metal		Soft	
3. Valve Specification Level (VSL)	VSL-2		VSL-2		VSL-2		VSL-2	
4. Ball Mouting	2" - 4"	Floating	2" - 4"	Floating	2" - 4"	Floating	2" - 4"	Floating
	6" - 30"	Trunnion	6" - 30"	Trunnion	6" - 30"	Trunnion	6" - 26"	Trunnion
5. Standard	API 6D / IOGP S-562		API 6D / IOGP S-562		API 6D		API 6D / IOGP S-562	
6. Size Range (NPS)	2" - 30"		2" - 30"		2" - 30"		2" - 26"	
7. End Connection	2" - 24"	ASME B16.5, RF	2" - 24"	ASME B16.5, RF	2" - 24"	ASME B16.5, RF	2" - 24"	ASME B16.5, RF
	26" - 30"	ASME B16.47 Series A, RF	26" - 30"	ASME B16.47 Series A, RF	26" - 30"	ASME B16.47 Series A, RF	26"	ASME B16.47 Series A, RF
8. Pressure Class	300		300		300		300	
9. Temperature	-46°C to 150°C		-46°C to 150°C		-46°C to 200°C		-29°C to 150°C	
10. Material Class	Carbon Steel		Carbon Steel		Carbon Steel		Carbon Steel	
11. Body Material	ASTM A350 Gr LF2 CL1 or ASTM A352 Gr LCB + Inconel 625 weld overlay (acc. item A.7.1.7.3)		ASTM A350 Gr LF2 CL1 or ASTM A352 Gr LCB + Inconel 625 weld overlay (acc. item A.7.1.7.3)		ASTM A350 Gr LF2 CL1 or ASTM A352 Gr LCB + Inconel 625 weld overlay (acc. item A.7.1.7.3)		ASTM A105 or ASTM A216 Gr WCB + Inconel 625 weld overlay (acc. item A.7.1.7.3)	
12. Obturator Material	AISI 316		AISI 316		AISI 316 + Tungsten carbide coating		ASTM A105 + Inconel 625 weld overlay (acc. item A.7.1.7.3)	
13. Seat Material	AISI 316		AISI 316		AISI 316 + Tungsten carbide coating		ASTM A105 + Inconel 625 weld overlay (acc. item A.7.1.7.3)	
14. Seat Insert	PTFE reinforced with 25% Carbon		PTFE reinforced with 25% Carbon		N/A		PTFE reinforced with 25% Carbon	
15. Spring (Seat) Material	UNS N07750		UNS N07750		UNS N07750		UNS N07750	
16. Stem Material	ASTM A276 (UNS S31600)		ASTM A276 (UNS S31600)		ASTM A276 (UNS S31600)		ASTM B637 (UNS N07718)	
17. Seat-Stem Seal	Group E (acc. item A.7.1.5.6)		Group E (acc. item A.7.1.5.6)		Group E (acc. item A.7.1.5.6)		Group B (acc. item A.7.1.5.6)	
18. Operator Type	2" - 4"	Lever	2" - 4"	Lever	2" - 4"	Lever	2" - 4"	Lever
	6" - 30"	Gearbox	6" - 30"	Gearbox	6" - 30"	Gearbox	6" - 26"	Gearbox
19. Additional Requirement	N/A		N/A		N/A		N/A	
20. Seat Type	Side A: SPE / Side B: SPE		Side A: SPE / Side B: DPE; DIB-2 & DBB		Side A: SPE / Side B: SPE		Side A: SPE / Side B: SPE	
21. Bore Type	Full Bore		Full Bore		Full Bore		Full Bore	
22. Body Construction	split body, bolted		split body, bolted		split body, bolted		split body, bolted	
23. Cladding or Coating	Partial clad - Inconel 625 weld overlay on all body sealing areas		Partial clad - Inconel 625 weld overlay on all body sealing areas		Partial clad - Inconel 625 weld overlay on all body sealing areas		Full clad - Inconel 625 weld overlay on all wetted parts	
24. Valve Testing	FAT according A.9.3		FAT according A.9.3		FAT according A.9.3		FAT according A.9.3	
25. Notes	N/A		N/A		N/A		N/A	

Valve Code	VES-300-2-C520		VES-300-2-C526		VES-300-2-C530		VES-300-2-C536	
Specs	C30		C30		C30		C30	
1. Valve Type	Ball		Ball		Ball		Ball	
2. Sealing Type	Soft		Soft		Soft		Soft	
3. Valve Specification Level (VSL)	VSL-2		VSL-2		VSL-2		VSL-2	
4. Ball Mouting	2" - 4"	Floating	2" - 4"	Floating	2" - 4"	Floating	2" - 4"	Floating
	6" - 26"	Trunnion	6" - 26"	Trunnion	6" - 26"	Trunnion	6" - 26"	Trunnion
5. Standard	API 6D / IOGP S-562		API 6D / IOGP S-562		API 6D / IOGP S-562		API 6D / IOGP S-562	
6. Size Range (NPS)	2" - 26"		2" - 26"		2" - 26"		2" - 26"	
7. End Connection	2" - 24"	ASME B16.5, RF	2" - 24"	ASME B16.5, RF	2" - 24"	ASME B16.5, RF	2" - 24"	ASME B16.5, RF
	26"	ASME B16.47 Series A, RF	26"	ASME B16.47 Series A, RF	26"	ASME B16.47 Series A, RF	26"	ASME B16.47 Series A, RF
8. Pressure Class	300		300		300		300	
9. Temperature	0°C to 150°C		0°C to 150°C		0°C to 150°C		0°C to 150°C	
10. Material Class	Carbon Steel		Carbon Steel		Carbon Steel		Carbon Steel	
11. Body Material	ASTM A105 or ASTM A216 Gr WCB + Inconel 625 weld overlay (acc. item A.7.1.7.3)		ASTM A105 or ASTM A216 Gr WCB + Inconel 625 weld overlay (acc. item A.7.1.7.3)		ASTM A105 or ASTM A216 Gr WCB + Inconel 625 weld overlay (acc. item A.7.1.7.3)		ASTM A105 or ASTM A216 Gr WCB + Inconel 625 weld overlay (acc. item A.7.1.7.3)	
12. Obturator Material	ASTM A105 + Inconel 625 weld overlay (acc. item A.7.1.7.3)		ASTM A105 + Inconel 625 weld overlay (acc. item A.7.1.7.3)		ASTM A105 + Inconel 625 weld overlay (acc. item A.7.1.7.3)		ASTM A105 + Inconel 625 weld overlay (acc. item A.7.1.7.3)	
13. Seat Material	ASTM A105 + Inconel 625 weld overlay (acc. item A.7.1.7.3)		ASTM A105 + Inconel 625 weld overlay (acc. item A.7.1.7.3)		ASTM A105 + Inconel 625 weld overlay (acc. item A.7.1.7.3)		ASTM A105 + Inconel 625 weld overlay (acc. item A.7.1.7.3)	
14. Seat Insert	PTFE reinforced with 25% Carbon		PTFE reinforced with 25% Carbon		PTFE reinforced with 25% Carbon		PTFE reinforced with 25% Carbon	
15. Spring (Seat) Material	UNS N07750		UNS N07750		UNS N07750		UNS N07750	
16. Stem Material	ASTM B637 (UNS N07718)		ASTM B637 (UNS N07718)		ASTM B637 (UNS N07718)		ASTM B637 (UNS N07718)	
17. Seat-Stem Seal	Group C (acc. item A.7.1.5.6)		Group C (acc. item A.7.1.5.6)		Group D (acc. item A.7.1.5.6)		Group D (acc. item A.7.1.5.6)	
18. Operator Type	2" - 4"	Lever	2" - 4"	Lever	2" - 4"	Lever	2" - 4"	Lever
	6" - 26"	Gearbox	6" - 26"	Gearbox	6" - 26"	Gearbox	6" - 26"	Gearbox
19. Additional Requirement	N/A		N/A		N/A		N/A	
20. Seat Type	Side A: SPE / Side B: SPE		Side A: SPE / Side B: DPE; DIB-2 & DBB		Side A: SPE / Side B: SPE		Side A: SPE / Side B: DPE; DIB-2 & DBB	
21. Bore Type	Full Bore		Full Bore		Full Bore		Full Bore	
22. Body Construction	split body, bolted		split body, bolted		split body, bolted		split body, bolted	
23. Cladding or Coating	Full clad - Inconel 625 weld overlay on all wetted parts		Full clad - Inconel 625 weld overlay on all wetted parts		Full clad - Inconel 625 weld overlay on all wetted parts		Full clad - Inconel 625 weld overlay on all wetted parts	
24. Valve Testing	FAT according A.9.3		FAT according A.9.3		FAT according A.9.3		FAT according A.9.3	
25. Notes	N/A		N/A		N/A		N/A	

Valve Code	VES-300-2-C560		VES-300-2-C562		VES-300-2-C570		VES-300-2-C572	
Specs	C30		C30		C30		C30	
1. Valve Type	Ball		Ball		Ball		Ball	
2. Sealing Type	Metal to Metal		Metal to Metal		Metal to Metal		Metal to Metal	
3. Valve Specification Level (VSL)	VSL-2		VSL-2		VSL-2		VSL-2	
4. Ball Mouting	2" - 4"	Floating	2" - 4"	Floating	2" - 4"	Floating	2" - 4"	Floating
	6" - 26"	Trunnion	6" - 26"	Trunnion	6" - 26"	Trunnion	6" - 26"	Trunnion
5. Standard	API 6D		API 6D		API 6D		API 6D	
6. Size Range (NPS)	2" - 26"		2" - 26"		2" - 26"		2" - 26"	
7. End Connection	2" - 24"	ASME B16.5, RF	2" - 24"	ASME B16.5, RF	2" - 24"	ASME B16.5, RF	2" - 24"	ASME B16.5, RF
	26"	ASME B16.47 Series A, RF	26"	ASME B16.47 Series A, RF	26"	ASME B16.47 Series A, RF	26"	ASME B16.47 Series A, RF
8. Pressure Class	300		300		300		300	
9. Temperature	0°C to 210°C		0°C to 210°C		0°C to 210°C		0°C to 210°C	
10. Material Class	Carbon Steel		Carbon Steel		Carbon Steel		Carbon Steel	
11. Body Material	ASTM A105 or ASTM A216 Gr WCB + Inconel 625 weld overlay (acc. item A.7.1.7.3)		ASTM A105 or ASTM A216 Gr WCB + Inconel 625 weld overlay (acc. item A.7.1.7.3)		ASTM A105 or ASTM A216 Gr WCB + Inconel 625 weld overlay (acc. item A.7.1.7.3)		ASTM A105 or ASTM A216 Gr WCB + Inconel 625 weld overlay (acc. item A.7.1.7.3)	
12. Obturator Material	ASTM A105 + Inconel 625 weld overlay (acc. item A.7.1.7.3) + Tungsten carbide coating		ASTM A105 + Inconel 625 weld overlay (acc. item A.7.1.7.3) + Tungsten carbide coating		ASTM A105 + Inconel 625 weld overlay (acc. item A.7.1.7.3) + Tungsten carbide coating		ASTM A105 + Inconel 625 weld overlay (acc. item A.7.1.7.3) + Tungsten carbide coating	
13. Seat Material	ASTM A105 + Inconel 625 weld overlay (acc. item A.7.1.7.3) + Tungsten carbide coating		ASTM A105 + Inconel 625 weld overlay (acc. item A.7.1.7.3) + Tungsten carbide coating		ASTM A105 + Inconel 625 weld overlay (acc. item A.7.1.7.3) + Tungsten carbide coating		ASTM A105 + Inconel 625 weld overlay (acc. item A.7.1.7.3) + Tungsten carbide coating	
14. Seat Insert	N/A		N/A		N/A		N/A	
15. Spring (Seat) Material	UNS N07750		UNS N07750		UNS N07750		UNS N07750	
16. Stem Material	ASTM B637 (UNS N07718)		ASTM B637 (UNS N07718)		ASTM B637 (UNS N07718)		ASTM B637 (UNS N07718)	
17. Seat-Stem Seal	Group C (acc. item A.7.1.5.6)		Group C (acc. item A.7.1.5.6)		Group D (acc. item A.7.1.5.6)		Group D (acc. item A.7.1.5.6)	
18. Operator Type	2" - 4"	Lever	2" - 4"	Lever	2" - 4"	Lever	2" - 4"	Lever
	6" - 26"	Gearbox	6" - 26"	Gearbox	6" - 26"	Gearbox	6" - 26"	Gearbox
19. Additional Requirement	N/A		N/A		N/A		N/A	
20. Seat Type	Side A: SPE / Side B: SPE		Side A: SPE / Side B: DPE; DIB-2 & DBB		Side A: SPE / Side B: SPE		Side A: SPE / Side B: DPE; DIB-2 & DBB	
21. Bore Type	Full Bore		Full Bore		Full Bore		Full Bore	
22. Body Construction	split body, bolted		split body, bolted		split body, bolted		split body, bolted	
23. Cladding or Coating	Full clad - Inconel 625 weld overlay on all wetted parts		Full clad - Inconel 625 weld overlay on all wetted parts		Full clad - Inconel 625 weld overlay on all wetted parts		Full clad - Inconel 625 weld overlay on all wetted parts	
24. Valve Testing	FAT according A.9.3		FAT according A.9.3		FAT according A.9.3		FAT according A.9.3	
25. Notes	N/A		N/A		N/A		N/A	

Valve Code	VES-300-2-D110		VES-300-2-D200		VES-300-2-D210		VES-300-2-D216	
Specs	C11		C11		C11 C16		C16	
1. Valve Type	Ball		Ball		Ball		Ball	
2. Sealing Type	Soft		Soft		Soft		Soft	
3. Valve Specification Level (VSL)	VSL-2		VSL-2		VSL-2		VSL-2	
4. Ball Mouting	2" - 4"	Floating	N/A		2" - 4"	Floating	2" - 4"	Floating
	6" - 16"	Trunnion	N/A		6" - 24"	Trunnion	6" - 24"	Trunnion
5. Standard	API 6D / IOGP S-562		API 6D		API 6D / IOGP S-562		API 6D / IOGP S-562	
6. Size Range (NPS)	2" - 16"		1" - 1 1/2"		2" - 24"		2" - 24"	
7. End Connection	ASME B16.5, RF		N/A		ASME B16.5, RF		ASME B16.5, RF	
8. Pressure Class	300		300		300		300	
9. Temperature	0°C to 120°C		0°C to 150°C		-30°C to 150°C		-30°C to 150°C	
10. Material Class	Duplex Steel		Duplex Steel		Duplex Steel		Duplex Steel	
11. Body Material	ASTM A995 Gr 1b		ASTM A182 Gr F51		ASTM A182 Gr F51 or ASTM A995 Gr 4a		ASTM A182 Gr F51 or ASTM A995 Gr 4a	
12. Obturator Material	Duplex (UNS S32550)		Duplex (UNS S31803)		Duplex (UNS S31803)		Duplex (UNS S31803)	
13. Seat Material	Duplex (UNS S32550)		PTFE reinforced with 25% Carbon		Duplex (UNS S31803)		Duplex (UNS S31803)	
14. Seat Insert	PTFE reinforced with 25% Carbon		N/A		PTFE reinforced with 25% Carbon		PTFE reinforced with 25% Carbon	
15. Spring (Seat) Material	UNS N07750		N/A		UNS N07750		UNS N07750	
16. Stem Material	ASTM A276 (UNS S32550)		ASTM A276 (UNS S31803)		ASTM A276 (UNS S31803)		ASTM A276 (UNS S31803)	
17. Seat-Stem Seal	Group B (acc. item A.7.1.5.6)		Group A (acc. item A.7.1.5.6)		Group B (acc. item A.7.1.5.6)		Group B (acc. item A.7.1.5.6)	
18. Operator Type	2" - 4"	Lever	N/A		2" - 4"	Lever	2" - 4"	Lever
	6" - 16"	Gearbox	N/A		6" - 24"	Gearbox	6" - 24"	Gearbox
19. Additional Requirement	N/A		Fire Tested (acc. item A.6.1.4)		N/A		N/A	
20. Seat Type	Side A: SPE / Side B: SPE		N/A		Side A: SPE / Side B: SPE		Side A: SPE / Side B: SPE	
21. Bore Type	Full Bore		Full Bore		Full Bore		Full Bore	
22. Body Construction	split body, bolted		split body, bolted		split body, bolted		split body, bolted	
23. Cladding or Coating	N/A		N/A		N/A		N/A	
24. Valve Testing	FAT according A.9.3		FAT according A.9.3		FAT according A.9.3		FAT according A.9.3	
25. Notes	N/A		N/A		N/A		N/A	

Valve Code	VES-300-2-D220		VES-300-2-D226		VES-300-2-D230		VES-300-2-D236	
Specs	C16		C16		C16		C16	
1. Valve Type	Ball		Ball		Ball		Ball	
2. Sealing Type	Soft		Soft		Soft		Soft	
3. Valve Specification Level (VSL)	VSL-2		VSL-2		VSL-2		VSL-2	
4. Ball Mouting	2" - 4"	Floating	2" - 4"	Floating	2" - 4"	Floating	2" - 4"	Floating
	6" - 24"	Trunnion	6" - 24"	Trunnion	6" - 24"	Trunnion	6" - 24"	Trunnion
5. Standard	API 6D / IOGP S-562		API 6D / IOGP S-562		API 6D / IOGP S-562		API 6D / IOGP S-562	
6. Size Range (NPS)	2" - 24"		2" - 24"		2" - 24"		2" - 24"	
7. End Connection	ASME B16.5, RF		ASME B16.5, RF		ASME B16.5, RF		ASME B16.5, RF	
8. Pressure Class	300		300		300		300	
9. Temperature	0°C to 150°C		0°C to 150°C		-46°C to 150°C		-46°C to 150°C	
10. Material Class	Duplex Steel		Duplex Steel		Duplex Steel		Duplex Steel	
11. Body Material	ASTM A182 Gr F51 or ASTM A995 Gr 4a		ASTM A182 Gr F51 or ASTM A995 Gr 4a		ASTM A182 Gr F51 or ASTM A995 Gr 4a		ASTM A182 Gr F51 or ASTM A995 Gr 4a	
12. Obturator Material	Duplex (UNS S31803)		Duplex (UNS S31803)		Duplex (UNS S31803)		Duplex (UNS S31803)	
13. Seat Material	Duplex (UNS S31803)		Duplex (UNS S31803)		Duplex (UNS S31803)		Duplex (UNS S31803)	
14. Seat Insert	PTFE reinforced with 25% Carbon		PTFE reinforced with 25% Carbon		PTFE reinforced with 25% Carbon		PTFE reinforced with 25% Carbon	
15. Spring (Seat) Material	UNS N07750		UNS N07750		UNS N07750		UNS N07750	
16. Stem Material	ASTM A276 (UNS S31803)		ASTM A276 (UNS S31803)		ASTM A276 (UNS S31803)		ASTM A276 (UNS S31803)	
17. Seat-Stem Seal	Group C (acc. item A.7.1.5.6)		Group C (acc. item A.7.1.5.6)		Group E (acc. item A.7.1.5.6)		Group E (acc. item A.7.1.5.6)	
18. Operator Type	2" - 4"	Lever	2" - 4"	Lever	2" - 4"	Lever	2" - 4"	Lever
	6" - 24"	Gearbox	6" - 24"	Gearbox	6" - 24"	Gearbox	6" - 24"	Gearbox
19. Additional Requirement	N/A		N/A		N/A		N/A	
20. Seat Type	Side A: SPE / Side B: SPE		Side A: SPE / Side B: DPE; DIB-2 & DBB		Side A: SPE / Side B: SPE		Side A: SPE / Side B: DPE; DIB-2 & DBB	
21. Bore Type	Full Bore		Full Bore		Full Bore		Full Bore	
22. Body Construction	split body, bolted		split body, bolted		split body, bolted		split body, bolted	
23. Cladding or Coating	N/A		N/A		N/A		N/A	
24. Valve Testing	FAT according A.9.3		FAT according A.9.3		FAT according A.9.3		FAT according A.9.3	
25. Notes	N/A		N/A		N/A		N/A	

Valve Code	VES-300-2-D250		VES-300-2-D252		VES-300-2-D260		VES-300-2-D262	
Specs	C16		C16		C16		C16	
1. Valve Type	Ball		Ball		Ball		Ball	
2. Sealing Type	Metal to Metal		Metal to Metal		Metal to Metal		Metal to Metal	
3. Valve Specification Level (VSL)	VSL-2		VSL-2		VSL-2		VSL-2	
4. Ball Mouting	2" - 4"	Floating	2" - 4"	Floating	2" - 4"	Floating	2" - 4"	Floating
	6" - 24"	Trunnion	6" - 24"	Trunnion	6" - 24"	Trunnion	6" - 24"	Trunnion
5. Standard	API 6D / IOGP S-562		API 6D / IOGP S-562		API 6D / IOGP S-562		API 6D / IOGP S-562	
6. Size Range (NPS)	2" - 24"		2" - 24"		2" - 24"		2" - 24"	
7. End Connection	ASME B16.5, RF		ASME B16.5, RF		ASME B16.5, RF		ASME B16.5, RF	
8. Pressure Class	300		300		300		300	
9. Temperature	-30°C to 150°C		-30°C to 150°C		0°C to 150°C		0°C to 150°C	
10. Material Class	Duplex Steel		Duplex Steel		Duplex Steel		Duplex Steel	
11. Body Material	ASTM A182 Gr F51 or ASTM A995 Gr 4a		ASTM A182 Gr F51 or ASTM A995 Gr 4a		ASTM A182 Gr F51 or ASTM A995 Gr 4a		ASTM A182 Gr F51 or ASTM A995 Gr 4a	
12. Obturator Material	Duplex (UNS S31803) + Tungsten carbide coating		Duplex (UNS S31803) + Tungsten carbide coating		Duplex (UNS S31803) + Tungsten carbide coating		Duplex (UNS S31803) + Tungsten carbide coating	
13. Seat Material	Duplex (UNS S31803) + Tungsten carbide coating		Duplex (UNS S31803) + Tungsten carbide coating		Duplex (UNS S31803) + Tungsten carbide coating		Duplex (UNS S31803) + Tungsten carbide coating	
14. Seat Insert	N/A		N/A		N/A		N/A	
15. Spring (Seat) Material	UNS N07750		UNS N07750		UNS N07750		UNS N07750	
16. Stem Material	ASTM A276 (UNS S31803)		ASTM A276 (UNS S31803)		ASTM A276 (UNS S31803)		ASTM A276 (UNS S31803)	
17. Seat-Stem Seal	Group B (acc. item A.7.1.5.6)		Group B (acc. item A.7.1.5.6)		Group C (acc. item A.7.1.5.6)		Group C (acc. item A.7.1.5.6)	
18. Operator Type	2" - 4"	Lever	2" - 4"	Lever	2" - 4"	Lever	2" - 4"	Lever
	6" - 24"	Gearbox	6" - 24"	Gearbox	6" - 24"	Gearbox	6" - 24"	Gearbox
19. Additional Requirement	N/A		N/A		N/A		N/A	
20. Seat Type	Side A: SPE / Side B: SPE		Side A: SPE / Side B: DPE; DIB-2 & DBB		Side A: SPE / Side B: SPE		Side A: SPE / Side B: DPE; DIB-2 & DBB	
21. Bore Type	Full Bore		Full Bore		Full Bore		Full Bore	
22. Body Construction	split body, bolted		split body, bolted		split body, bolted		split body, bolted	
23. Cladding or Coating	N/A		N/A		N/A		N/A	
24. Valve Testing	FAT according A.9.3		FAT according A.9.3		FAT according A.9.3		FAT according A.9.3	
25. Notes	N/A		N/A		N/A		N/A	

Valve Code	VES-300-2-D270		VES-300-2-D272		VES-300-2-D310		VES-300-2-D316	
Specs	C16		C16		C12		C12	
1. Valve Type	Ball		Ball		Ball		Ball	
2. Sealing Type	Metal to Metal		Metal to Metal		Soft		Soft	
3. Valve Specification Level (VSL)	VSL-2		VSL-2		VSL-2		VSL-2	
4. Ball Mouting	2" - 4"	Floating	2" - 4"	Floating	2" - 4"	Floating	2" - 4"	Floating
	6" - 24"	Trunnion	6" - 24"	Trunnion	6" - 30"	Trunnion	6" - 30"	Trunnion
5. Standard	API 6D / IOGP S-562		API 6D / IOGP S-562		API 6D / IOGP S-562		API 6D / IOGP S-562	
6. Size Range (NPS)	2" - 24"		2" - 24"		2" - 30"		2" - 30"	
7. End Connection	ASME B16.5, RF		ASME B16.5, RF		2" - 24"	ASME B16.5, RF	2" - 24"	ASME B16.5, RF
	N/A		N/A		26" - 30"	ASME B16.47 Series A, RF	26" - 30"	ASME B16.47 Series A, RF
8. Pressure Class	300		300		300		300	
9. Temperature	-46°C to 150°C		-46°C to 150°C		-30°C to 150°C		-30°C to 150°C	
10. Material Class	Duplex Steel		Duplex Steel		Duplex Steel		Duplex Steel	
11. Body Material	ASTM A182 Gr F51 or ASTM A995 Gr 4a		ASTM A182 Gr F51 or ASTM A995 Gr 4a		ASTM A182 Gr F55 or ASTM A995 Gr 6a		ASTM A182 Gr F55 or ASTM A995 Gr 6a	
12. Obturator Material	Duplex (UNS S31803) + Tungsten carbide coating		Duplex (UNS S31803) + Tungsten carbide coating		Super Duplex (UNS S32760)		Super Duplex (UNS S32760)	
13. Seat Material	Duplex (UNS S31803) + Tungsten carbide coating		Duplex (UNS S31803) + Tungsten carbide coating		Super Duplex (UNS S32760)		Super Duplex (UNS S32760)	
14. Seat Insert	N/A		N/A		PTFE reinforced with 25% Carbon		PTFE reinforced with 25% Carbon	
15. Spring (Seat) Material	UNS N07750		UNS N07750		UNS N07750		UNS N07750	
16. Stem Material	ASTM A276 (UNS S31803)		ASTM A276 (UNS S31803)		ASTM A276 (UNS S32760)		ASTM A276 (UNS S32760)	
17. Seat-Stem Seal	Group E (acc. item A.7.1.5.6)		Group E (acc. item A.7.1.5.6)		Group B (acc. item A.7.1.5.6)		Group B (acc. item A.7.1.5.6)	
18. Operator Type	2" - 4"	Lever	2" - 4"	Lever	2" - 4"	Lever	2" - 4"	Lever
	6" - 24"	Gearbox	6" - 24"	Gearbox	6" - 30"	Gearbox	6" - 30"	Gearbox
19. Additional Requirement	N/A		N/A		N/A		N/A	
20. Seat Type	Side A: SPE / Side B: SPE		Side A: SPE / Side B: DPE; DIB-2 & DBB		Side A: SPE / Side B: SPE		Side A: SPE / Side B: DPE; DIB-2 & DBB	
21. Bore Type	Full Bore		Full Bore		Full Bore		Full Bore	
22. Body Construction	split body, bolted		split body, bolted		split body, bolted		split body, bolted	
23. Cladding or Coating	N/A		N/A		N/A		N/A	
24. Valve Testing	FAT according A.9.3		FAT according A.9.3		FAT according A.9.3		FAT according A.9.3	
25. Notes	N/A		N/A		N/A		N/A	

Valve Code	VES-300-2-D330		VES-300-2-D336		VES-300-2-S210		VES-300-2-S216	
Specs	C12		C12		C3		C3	
1. Valve Type	Ball		Ball		Ball		Ball	
2. Sealing Type	Soft		Soft		Soft		Soft	
3. Valve Specification Level (VSL)	VSL-2		VSL-2		VSL-2		VSL-2	
4. Ball Mouting	2" - 4"	Floating	2" - 4"	Floating	2" - 4"	Floating	2" - 4"	Floating
	6" - 30"	Trunnion	6" - 30"	Trunnion	6" - 30"	Trunnion	6" - 30"	Trunnion
5. Standard	API 6D / IOGP S-562		API 6D / IOGP S-562		API 6D / IOGP S-562		API 6D / IOGP S-562	
6. Size Range (NPS)	2" - 30"		2" - 30"		2" - 30"		2" - 30"	
7. End Connection	2" - 24"	ASME B16.5, RF	2" - 24"	ASME B16.5, RF	2" - 24"	ASME B16.5, RF	2" - 24"	ASME B16.5, RF
	26" - 30"	ASME B16.47 Series A, RF	26" - 30"	ASME B16.47 Series A, RF	26" - 30"	ASME B16.47 Series A, RF	26" - 30"	ASME B16.47 Series A, RF
8. Pressure Class	300		300		300		300	
9. Temperature	0°C to 150°C		0°C to 150°C		-30°C to 150°C		-30°C to 150°C	
10. Material Class	Duplex Steel		Duplex Steel		Stainless Steel		Stainless Steel	
11. Body Material	ASTM A182 Gr F55 or ASTM A995 Gr 6a		ASTM A182 Gr F55 or ASTM A995 Gr 6a		ASTM A182 Gr F316 or ASTM A351 Gr CF8M		ASTM A182 Gr F316 or ASTM A351 Gr CF8M	
12. Obturator Material	Super Duplex (UNS S32760)		Super Duplex (UNS S32760)		AISI 316		AISI 316	
13. Seat Material	Super Duplex (UNS S32760)		Super Duplex (UNS S32760)		AISI 316		AISI 316	
14. Seat Insert	PTFE reinforced with 25% Carbon		PTFE reinforced with 25% Carbon		PTFE reinforced with 25% Carbon		PTFE reinforced with 25% Carbon	
15. Spring (Seat) Material	UNS N07750		UNS N07750		UNS N07750		UNS N07750	
16. Stem Material	ASTM A276 (UNS S32760)		ASTM A276 (UNS S32760)		ASTM A276 (UNS S31600)		ASTM A276 (UNS S31600)	
17. Seat-Stem Seal	Group D (acc. item A.7.1.5.6)		Group D (acc. item A.7.1.5.6)		Group B (acc. item A.7.1.5.6)		Group B (acc. item A.7.1.5.6)	
18. Operator Type	2" - 4"	Lever	2" - 4"	Lever	2" - 4"	Lever	2" - 4"	Lever
	6" - 30"	Gearbox	6" - 30"	Gearbox	6" - 30"	Gearbox	6" - 30"	Gearbox
19. Additional Requirement	N/A		N/A		N/A		N/A	
20. Seat Type	Side A: SPE / Side B: SPE		Side A: SPE / Side B: DPE; DIB-2 & DBB		Side A: SPE / Side B: SPE		Side A: SPE / Side B: DPE; DIB-2 & DBB	
21. Bore Type	Full Bore		Full Bore		Full Bore		Full Bore	
22. Body Construction	split body, bolted		split body, bolted		split body, bolted		split body, bolted	
23. Cladding or Coating	N/A		N/A		N/A		N/A	
24. Valve Testing	FAT according A.9.3		FAT according A.9.3		FAT according A.9.3		FAT according A.9.3	
25. Notes	N/A		N/A		N/A		N/A	

Valve Code	VES-300-2-S220		VES-300-2-S226		VES-300-2-S230		VES-300-2-S236	
Specs	C3		C3		C3		C3	
1. Valve Type	Ball		Ball		Ball		Ball	
2. Sealing Type	Soft		Soft		Soft		Soft	
3. Valve Specification Level (VSL)	VSL-2		VSL-2		VSL-2		VSL-2	
4. Ball Mouting	2" - 4"	Floating	2" - 4"	Floating	2" - 4"	Floating	2" - 4"	Floating
	6" - 30"	Trunnion	6" - 30"	Trunnion	6" - 30"	Trunnion	6" - 30"	Trunnion
5. Standard	API 6D / IOGP S-562		API 6D / IOGP S-562		API 6D / IOGP S-562		API 6D / IOGP S-562	
6. Size Range (NPS)	2" - 30"		2" - 30"		2" - 30"		2" - 30"	
7. End Connection	2" - 24"	ASME B16.5, RF	2" - 24"	ASME B16.5, RF	2" - 24"	ASME B16.5, RF	2" - 24"	ASME B16.5, RF
	26" - 30"	ASME B16.47 Series A, RF	26" - 30"	ASME B16.47 Series A, RF	26" - 30"	ASME B16.47 Series A, RF	26" - 30"	ASME B16.47 Series A, RF
8. Pressure Class	300		300		300		300	
9. Temperature	0°C to 150°C		0°C to 150°C		-46°C to 150°C		-46°C to 150°C	
10. Material Class	Stainless Steel		Stainless Steel		Stainless Steel		Stainless Steel	
11. Body Material	ASTM A182 Gr F316 or ASTM A351 Gr CF8M		ASTM A182 Gr F316 or ASTM A351 Gr CF8M		ASTM A182 Gr F316 or ASTM A351 Gr CF8M		ASTM A182 Gr F316 or ASTM A351 Gr CF8M	
12. Obturator Material	AISI 316		AISI 316		AISI 316		AISI 316	
13. Seat Material	AISI 316		AISI 316		AISI 316		AISI 316	
14. Seat Insert	PTFE reinforced with 25% Carbon		PTFE reinforced with 25% Carbon		PTFE reinforced with 25% Carbon		PTFE reinforced with 25% Carbon	
15. Spring (Seat) Material	UNS N07750		UNS N07750		UNS N07750		UNS N07750	
16. Stem Material	ASTM A276 (UNS S31600)		ASTM A276 (UNS S31600)		ASTM A276 (UNS S31600)		ASTM A276 (UNS S31600)	
17. Seat-Stem Seal	Group C (acc. item A.7.1.5.6)		Group C (acc. item A.7.1.5.6)		Group E (acc. item A.7.1.5.6)		Group E (acc. item A.7.1.5.6)	
18. Operator Type	2" - 4"	Lever	2" - 4"	Lever	2" - 4"	Lever	2" - 4"	Lever
	6" - 30"	Gearbox	6" - 30"	Gearbox	6" - 30"	Gearbox	6" - 30"	Gearbox
19. Additional Requirement	N/A		N/A		N/A		N/A	
20. Seat Type	Side A: SPE / Side B: SPE		Side A: SPE / Side B: DPE; DIB-2 & DBB		Side A: SPE / Side B: SPE		Side A: SPE / Side B: DPE; DIB-2 & DBB	
21. Bore Type	Full Bore		Full Bore		Full Bore		Full Bore	
22. Body Construction	split body, bolted		split body, bolted		split body, bolted		split body, bolted	
23. Cladding or Coating	N/A		N/A		N/A		N/A	
24. Valve Testing	FAT according A.9.3		FAT according A.9.3		FAT according A.9.3		FAT according A.9.3	
25. Notes	N/A		N/A		N/A		N/A	

Valve Code	VES-300-2-S270		VES-300-3-C116		VES-300-3-C117		VES-300-3-C126	
Specs	C3		C9 C10		C9 C10		C9 C10	
1. Valve Type	Ball		Ball		Ball		Ball	
2. Sealing Type	Metal to Metal		Soft		Soft		Soft	
3. Valve Specification Level (VSL)	VSL-2		VSL-3		VSL-3		VSL-3	
4. Ball Mouting	2" - 4"	Floating	2" - 4"	Floating	2" - 4"	Floating	2" - 4"	Floating
	6" - 30"	Trunnion	6" - 32"	Trunnion	6" - 32"	Trunnion	6" - 32"	Trunnion
5. Standard	API 6D		API 6D / IOGP S-562		API 6D / IOGP S-562		API 6D / IOGP S-562	
6. Size Range (NPS)	2" - 30"		2" - 32"		2" - 32"		2" - 32"	
7. End Connection	2" - 24"	ASME B16.5, RF	2" - 24"	ASME B16.5, RF	2" - 24"	ASME B16.5, RF	2" - 24"	ASME B16.5, RF
	26" - 30"	ASME B16.47 Series A, RF	26" - 32"	ASME B16.47 Series A, RF	26" - 32"	ASME B16.47 Series A, RF	26" - 32"	ASME B16.47 Series A, RF
8. Pressure Class	300		300		300		300	
9. Temperature	-100°C to 200°C		-29°C to 150°C		-29°C to 150°C		0°C to 150°C	
10. Material Class	Stainless Steel		Carbon Steel		Carbon Steel		Carbon Steel	
11. Body Material	ASTM A182 Gr F316 or ASTM A351 Gr CF8M		ASTM A105 + SS316 weld overlay (acc. item A.7.1.7.3)		ASTM A105 + SS316 weld overlay (acc. item A.7.1.7.3)		ASTM A105 + SS316 weld overlay (acc. item A.7.1.7.3)	
12. Obturator Material	AISI 316 + Tungsten carbide coating		AISI 410		AISI 410		AISI 410	
13. Seat Material	AISI 316 + Tungsten carbide coating		AISI 410		AISI 410		AISI 410	
14. Seat Insert	N/A		PTFE reinforced with 25% Carbon		PTFE reinforced with 25% Carbon		PTFE reinforced with 25% Carbon	
15. Spring (Seat) Material	UNS N07750		UNS N07750		UNS N07750		UNS N07750	
16. Stem Material	ASTM A276 (UNS S31600)		ASTM A276 (UNS S41000)		ASTM A276 (UNS S41000)		ASTM A276 (UNS S41000)	
17. Seat-Stem Seal	Group E (acc. item A.7.1.5.6)		Group B (acc. item A.7.1.5.6)		Group B (acc. item A.7.1.5.6)		Group C (acc. item A.7.1.5.6)	
18. Operator Type	2" - 4"	Lever	2" - 4"	Lever	2" - 4"	Lever	2" - 4"	Lever
	6" - 30"	Gearbox	6" - 32"	Gearbox	6" - 32"	Gearbox	6" - 32"	Gearbox
19. Additional Requirement	N/A		N/A		Fire Tested (acc. item A.6.1.4)		N/A	
20. Seat Type	Side A: SPE / Side B: SPE		Side A: SPE / Side B: DPE; DIB-2 & DBB		Side A: SPE / Side B: DPE; DIB-2 & DBB		Side A: SPE / Side B: DPE; DIB-2 & DBB	
21. Bore Type	Full Bore		Full Bore		Full Bore		Full Bore	
22. Body Construction	split body, bolted		split body, bolted		split body, bolted		split body, bolted	
23. Cladding or Coating	N/A		Partial clad - SS316 weld overlay on all body sealing areas		Partial clad - SS316 weld overlay on all body sealing areas		Partial clad - SS316 weld overlay on all body sealing areas	
24. Valve Testing	FAT according A.9.3		FAT according A.9.3		FAT according A.9.3		FAT according A.9.3	
25. Notes	N/A		N/A		N/A		N/A	

Valve Code	VES-300-3-C127		VES-300-3-C136		VES-300-3-C137		VES-300-3-C152	
Specs	C9 C10		C9 C10		C9 C10		C9 C10	
1. Valve Type	Ball		Ball		Ball		Ball	
2. Sealing Type	Soft		Soft		Soft		Metal to Metal	
3. Valve Specification Level (VSL)	VSL-3		VSL-3		VSL-3		VSL-3	
4. Ball Mouting	2" - 4"	Floating	2" - 4"	Floating	2" - 4"	Floating	2" - 4"	Floating
	6" - 32"	Trunnion	6" - 32"	Trunnion	6" - 32"	Trunnion	6" - 32"	Trunnion
5. Standard	API 6D / IOGP S-562		API 6D / IOGP S-562		API 6D / IOGP S-562		API 6D / IOGP S-562	
6. Size Range (NPS)	2" - 32"		2" - 32"		2" - 32"		2" - 32"	
7. End Connection	2" - 24"	ASME B16.5, RF	2" - 24"	ASME B16.5, RF	2" - 24"	ASME B16.5, RF	2" - 24"	ASME B16.5, RF
	26" - 32"	ASME B16.47 Series A, RF	26" - 32"	ASME B16.47 Series A, RF	26" - 32"	ASME B16.47 Series A, RF	26" - 32"	ASME B16.47 Series A, RF
8. Pressure Class	300		300		300		300	
9. Temperature	0°C to 150°C		0°C to 150°C		0°C to 150°C		0°C to 150°C	
10. Material Class	Carbon Steel		Carbon Steel		Carbon Steel		Carbon Steel	
11. Body Material	ASTM A105 + SS316 weld overlay (acc. item A.7.1.7.3)		ASTM A105 + SS316 weld overlay (acc. item A.7.1.7.3)		ASTM A105 + SS316 weld overlay (acc. item A.7.1.7.3)		ASTM A105 + SS316 weld overlay (acc. item A.7.1.7.3)	
12. Obturator Material	AISI 410		AISI 410		AISI 410		AISI 410 + Tungsten carbide coating	
13. Seat Material	AISI 410		AISI 410		AISI 410		AISI 410 + Tungsten carbide coating	
14. Seat Insert	PTFE reinforced with 25% Carbon		PTFE reinforced with 25% Carbon		PTFE reinforced with 25% Carbon		N/A	
15. Spring (Seat) Material	UNS N07750		UNS N07750		UNS N07750		UNS N07750	
16. Stem Material	ASTM A276 (UNS S41000)		ASTM A276 (UNS S41000)		ASTM A276 (UNS S41000)		ASTM A276 (UNS S41000)	
17. Seat-Stem Seal	Group C (acc. item A.7.1.5.6)		Group D (acc. item A.7.1.5.6)		Group D (acc. item A.7.1.5.6)		Group A (acc. item A.7.1.5.6)	
18. Operator Type	2" - 4"	Lever	2" - 4"	Lever	2" - 4"	Lever	2" - 4"	Lever
	6" - 32"	Gearbox	6" - 32"	Gearbox	6" - 32"	Gearbox	6" - 32"	Gearbox
19. Additional Requirement	Fire Tested (acc. item A.6.1.4)		N/A		Fire Tested (acc. item A.6.1.4)		N/A	
20. Seat Type	Side A: SPE / Side B: DPE; DIB-2 & DBB		Side A: SPE / Side B: DPE; DIB-2 & DBB		Side A: SPE / Side B: DPE; DIB-2 & DBB		Side A: SPE / Side B: DPE; DIB-2 & DBB	
21. Bore Type	Full Bore		Full Bore		Full Bore		Full Bore	
22. Body Construction	split body, bolted		split body, bolted		split body, bolted		split body, bolted	
23. Cladding or Coating	Partial clad - SS316 weld overlay on all body sealing areas		Partial clad - SS316 weld overlay on all body sealing areas		Partial clad - SS316 weld overlay on all body sealing areas		Partial clad - SS316 weld overlay on all body sealing areas	
24. Valve Testing	FAT according A.9.3		FAT according A.9.3		FAT according A.9.3		FAT according A.9.3	
25. Notes	N/A		N/A		N/A		Acceptance criteria for sealing tests see Annex A	

Valve Code	VES-300-3-C153		VES-300-3-C162		VES-300-3-C163		VES-300-3-C172	
Specs	C9 C10		C9 C10		C4 C9 C10		C9 C10	
1. Valve Type	Ball		Ball		Ball		Ball	
2. Sealing Type	Metal to Metal		Metal to Metal		Metal to Metal		Metal to Metal	
3. Valve Specification Level (VSL)	VSL-3		VSL-3		VSL-3		VSL-3	
4. Ball Mouting	2" - 4"	Floating	2" - 4"	Floating	2" - 4"	Floating	2" - 4"	Floating
	6" - 32"	Trunnion	6" - 32"	Trunnion	6" - 32"	Trunnion	6" - 32"	Trunnion
5. Standard	API 6D / IOGP S-562		API 6D		API 6D		API 6D	
6. Size Range (NPS)	2" - 32"		2" - 32"		2" - 32"		2" - 32"	
7. End Connection	2" - 24"	ASME B16.5, RF	2" - 24"	ASME B16.5, RF	2" - 24"	ASME B16.5, RF	2" - 24"	ASME B16.5, RF
	26" - 32"	ASME B16.47 Series A, RF	26" - 32"	ASME B16.47 Series A, RF	26" - 32"	ASME B16.47 Series A, RF	26" - 32"	ASME B16.47 Series A, RF
8. Pressure Class	300		300		300		300	
9. Temperature	0°C to 150°C		0°C to 210°C		0°C to 210°C		0°C to 210°C	
10. Material Class	Carbon Steel		Carbon Steel		Carbon Steel		Carbon Steel	
11. Body Material	ASTM A105 + SS316 weld overlay (acc. item A.7.1.7.3)		ASTM A105 + SS316 weld overlay (acc. item A.7.1.7.3)		ASTM A105 + SS316 weld overlay (acc. item A.7.1.7.3)		ASTM A105 + SS316 weld overlay (acc. item A.7.1.7.3)	
12. Obturator Material	AISI 410 + Tungsten carbide coating		AISI 410 + Tungsten carbide coating		AISI 410 + Tungsten carbide coating		AISI 410 + Tungsten carbide coating	
13. Seat Material	AISI 410 + Tungsten carbide coating		AISI 410 + Tungsten carbide coating		AISI 410 + Tungsten carbide coating		AISI 410 + Tungsten carbide coating	
14. Seat Insert	N/A		N/A		N/A		N/A	
15. Spring (Seat) Material	UNS N07750		UNS N07750		UNS N07750		UNS N07750	
16. Stem Material	ASTM A276 (UNS S41000)		ASTM A276 (UNS S41000)		ASTM A276 (UNS S41000)		ASTM A276 (UNS S41000)	
17. Seat-Stem Seal	Group A (acc. item A.7.1.5.6)		Group C (acc. item A.7.1.5.6)		Group C (acc. item A.7.1.5.6)		Group D (acc. item A.7.1.5.6)	
18. Operator Type	2" - 4"	Lever	2" - 4"	Lever	2" - 4"	Lever	2" - 4"	Lever
	6" - 32"	Gearbox	6" - 32"	Gearbox	6" - 32"	Gearbox	6" - 32"	Gearbox
19. Additional Requirement	Fire Tested (acc. item A.6.1.4)		N/A		Fire Tested (acc. item A.6.1.4)		N/A	
20. Seat Type	Side A: SPE / Side B: DPE; DIB-2 & DBB		Side A: SPE / Side B: DPE; DIB-2 & DBB		Side A: SPE / Side B: DPE; DIB-2 & DBB		Side A: SPE / Side B: DPE; DIB-2 & DBB	
21. Bore Type	Full Bore		Full Bore		Full Bore		Full Bore	
22. Body Construction	split body, bolted		split body, bolted		split body, bolted		split body, bolted	
23. Cladding or Coating	Partial clad - SS316 weld overlay on all body sealing areas		Partial clad - SS316 weld overlay on all body sealing areas		Partial clad - SS316 weld overlay on all body sealing areas		Partial clad - SS316 weld overlay on all body sealing areas	
24. Valve Testing	FAT according A.9.3		FAT according A.9.3		FAT according A.9.3		FAT according A.9.3	
25. Notes	Acceptance criteria for sealing tests see Annex A		Acceptance criteria for sealing tests see Annex A		Acceptance criteria for sealing tests see Annex A		Acceptance criteria for sealing tests see Annex A	

Valve Code	VES-300-3-C173		VES-300-3-C182		VES-300-3-C183		VES-300-3-C216	
Specs	C9 C10		C9 C10		C9 C10		C6 C19	
1. Valve Type	Ball		Ball		Ball		Ball	
2. Sealing Type	Metal to Metal		Metal to Metal		Metal to Metal		Soft	
3. Valve Specification Level (VSL)	VSL-3		VSL-3		VSL-3		VSL-3	
4. Ball Mouting	2" - 4"	Floating	2" - 4"	Floating	2" - 4"	Floating	2" - 4"	Floating
	6" - 32"	Trunnion	6" - 32"	Trunnion	6" - 32"	Trunnion	6" - 30"	Trunnion
5. Standard	API 6D		API 6D		API 6D		API 6D / IOGP S-562	
6. Size Range (NPS)	2" - 32"		2" - 32"		2" - 32"		2" - 30"	
7. End Connection	2" - 24"	ASME B16.5, RF	2" - 24"	ASME B16.5, RF	2" - 24"	ASME B16.5, RF	2" - 24"	ASME B16.5, RF
	26" - 32"	ASME B16.47 Series A, RF	26" - 32"	ASME B16.47 Series A, RF	26" - 32"	ASME B16.47 Series A, RF	26" - 30"	ASME B16.47 Series A, RF
8. Pressure Class	300		300		300		300	
9. Temperature	0°C to 210°C		0°C to 400°C		0°C to 400°C		-30°C to 150°C	
10. Material Class	Carbon Steel		Carbon Steel		Carbon Steel		Carbon Steel	
11. Body Material	ASTM A105 + SS316 weld overlay (acc. item A.7.1.7.3)		ASTM A105 + SS316 weld overlay (acc. item A.7.1.7.3)		ASTM A105 + SS316 weld overlay (acc. item A.7.1.7.3)		ASTM A350 Gr LF2 CL1 + Inconel 625 weld overlay (acc. item A.7.1.7.3)	
12. Obturator Material	AISI 410 + Tungsten carbide coating		AISI 410 + Chrome-Nickel Spray and Fuse (acc. Item A.8.2.2.4)		AISI 410 + Chrome-Nickel Spray and Fuse (acc. Item A.8.2.2.4)		AISI 316	
13. Seat Material	AISI 410 + Tungsten carbide coating		AISI 410 + Chrome-Nickel Spray and Fuse (acc. Item A.8.2.2.4)		AISI 410 + Chrome-Nickel Spray and Fuse (acc. Item A.8.2.2.4)		AISI 316	
14. Seat Insert	N/A		N/A		N/A		PTFE reinforced with 25% Carbon	
15. Spring (Seat) Material	UNS N07750		UNS N07750		UNS N07750		UNS N07750	
16. Stem Material	ASTM A276 (UNS S41000)		ASTM A276 (UNS S41000)		ASTM A276 (UNS S41000)		ASTM A276 (UNS S31600)	
17. Seat-Stem Seal	Group D (acc. item A.7.1.5.6)		Group F (acc. item A.7.1.5.6)		Group F (acc. item A.7.1.5.6)		Group B (acc. item A.7.1.5.6)	
18. Operator Type	2" - 4"	Lever	2" - 4"	Lever	2" - 4"	Lever	2" - 4"	Lever
	6" - 32"	Gearbox	6" - 32"	Gearbox	6" - 32"	Gearbox	6" - 30"	Gearbox
19. Additional Requirement	Fire Tested (acc. item A.6.1.4)		N/A		Fire Tested (acc. item A.6.1.4)		N/A	
20. Seat Type	Side A: SPE / Side B: DPE; DIB-2 & DBB		Side A: SPE / Side B: DPE; DIB-2 & DBB		Side A: SPE / Side B: DPE; DIB-2 & DBB		Side A: SPE / Side B: DPE; DIB-2 & DBB	
21. Bore Type	Full Bore		Full Bore		Full Bore		Full Bore	
22. Body Construction	split body, bolted		split body, bolted		split body, bolted		split body, bolted	
23. Cladding or Coating	Partial clad - SS316 weld overlay on all body sealing areas		Partial clad - SS316 weld overlay on all body sealing areas		Partial clad - SS316 weld overlay on all body sealing areas		Partial clad - Inconel 625 weld overlay on all body sealing areas	
24. Valve Testing	FAT according A.9.3		FAT according A.9.3		FAT according A.9.3		FAT according A.9.3	
25. Notes	Acceptance criteria for sealing tests see Annex A		Acceptance criteria for sealing tests see Annex A		Acceptance criteria for sealing tests see Annex A		N/A	

Valve Code	VES-300-3-C217		VES-300-3-C236		VES-300-3-C237		VES-300-3-C252	
Specs	C6 C19		C6 C19		C6 C19		C6 C19	
1. Valve Type	Ball		Ball		Ball		Ball	
2. Sealing Type	Soft		Soft		Soft		Metal to Metal	
3. Valve Specification Level (VSL)	VSL-3		VSL-3		VSL-3		VSL-3	
4. Ball Mouting	2" - 4"	Floating	2" - 4"	Floating	2" - 4"	Floating	2" - 4"	Floating
	6" - 30"	Trunnion	6" - 30"	Trunnion	6" - 30"	Trunnion	6" - 30"	Trunnion
5. Standard	API 6D / IOGP S-562		API 6D / IOGP S-562		API 6D / IOGP S-562		API 6D / IOGP S-562	
6. Size Range (NPS)	2" - 30"		2" - 30"		2" - 30"		2" - 30"	
7. End Connection	2" - 24"	ASME B16.5, RF	2" - 24"	ASME B16.5, RF	2" - 24"	ASME B16.5, RF	2" - 24"	ASME B16.5, RF
	26" - 30"	ASME B16.47 Series A, RF	26" - 30"	ASME B16.47 Series A, RF	26" - 30"	ASME B16.47 Series A, RF	26" - 30"	ASME B16.47 Series A, RF
8. Pressure Class	300		300		300		300	
9. Temperature	-30°C to 150°C		-46°C to 150°C		-46°C to 150°C		-30°C to 150°C	
10. Material Class	Carbon Steel		Carbon Steel		Carbon Steel		Carbon Steel	
11. Body Material	ASTM A350 Gr LF2 CL1 + Inconel 625 weld overlay (acc. item A.7.1.7.3)		ASTM A350 Gr LF2 CL1 + Inconel 625 weld overlay (acc. item A.7.1.7.3)		ASTM A350 Gr LF2 CL1 + Inconel 625 weld overlay (acc. item A.7.1.7.3)		ASTM A350 Gr LF2 CL1 + Inconel 625 weld overlay (acc. item A.7.1.7.3)	
12. Obturator Material	AISI 316		AISI 316		AISI 316		AISI 316 + Tungsten carbide coating	
13. Seat Material	AISI 316		AISI 316		AISI 316		AISI 316 + Tungsten carbide coating	
14. Seat Insert	PTFE reinforced with 25% Carbon		PTFE reinforced with 25% Carbon		PTFE reinforced with 25% Carbon		N/A	
15. Spring (Seat) Material	UNS N07750		UNS N07750		UNS N07750		UNS N07750	
16. Stem Material	ASTM A276 (UNS S31600)		ASTM A276 (UNS S31600)		ASTM A276 (UNS S31600)		ASTM A276 (UNS S31600)	
17. Seat-Stem Seal	Group B (acc. item A.7.1.5.6)		Group E (acc. item A.7.1.5.6)		Group E (acc. item A.7.1.5.6)		Group B (acc. item A.7.1.5.6)	
18. Operator Type	2" - 4"	Lever	2" - 4"	Lever	2" - 4"	Lever	2" - 4"	Lever
	6" - 30"	Gearbox	6" - 30"	Gearbox	6" - 30"	Gearbox	6" - 30"	Gearbox
19. Additional Requirement	Fire Tested (acc. item A.6.1.4)		N/A		Fire Tested (acc. item A.6.1.4)		N/A	
20. Seat Type	Side A: SPE / Side B: DPE; DIB-2 & DBB		Side A: SPE / Side B: DPE; DIB-2 & DBB		Side A: SPE / Side B: DPE; DIB-2 & DBB		Side A: SPE / Side B: DPE; DIB-2 & DBB	
21. Bore Type	Full Bore		Full Bore		Full Bore		Full Bore	
22. Body Construction	split body, bolted		split body, bolted		split body, bolted		split body, bolted	
23. Cladding or Coating	Partial clad - Inconel 625 weld overlay on all body sealing areas		Partial clad - Inconel 625 weld overlay on all body sealing areas		Partial clad - Inconel 625 weld overlay on all body sealing areas		Partial clad - Inconel 625 weld overlay on all body sealing areas	
24. Valve Testing	FAT according A.9.3		FAT according A.9.3		FAT according A.9.3		FAT according A.9.3	
25. Notes	N/A		N/A		N/A		Acceptance criteria for sealing tests see Annex A	

Valve Code	VES-300-3-C253		VES-300-3-C272		VES-300-3-C273		VES-300-3-C517	
Specs	C6 C19		C6 C19		C6 C19		C30	
1. Valve Type	Ball		Ball		Ball		Ball	
2. Sealing Type	Metal to Metal		Metal to Metal		Metal to Metal		Soft	
3. Valve Specification Level (VSL)	VSL-3		VSL-3		VSL-3		VSL-3	
4. Ball Mouting	2" - 4"	Floating	2" - 4"	Floating	2" - 4"	Floating	2" - 4"	Floating
	6" - 30"	Trunnion	6" - 30"	Trunnion	6" - 30"	Trunnion	6" - 26"	Trunnion
5. Standard	API 6D / IOGP S-562		API 6D		API 6D		API 6D / IOGP S-562	
6. Size Range (NPS)	2" - 30"		2" - 30"		2" - 30"		2" - 26"	
7. End Connection	2" - 24"	ASME B16.5, RF	2" - 24"	ASME B16.5, RF	2" - 24"	ASME B16.5, RF	2" - 24"	ASME B16.5, RF
	26" - 30"	ASME B16.47 Series A, RF	26" - 30"	ASME B16.47 Series A, RF	26" - 30"	ASME B16.47 Series A, RF	26"	ASME B16.47 Series A, RF
8. Pressure Class	300		300		300		300	
9. Temperature	-30°C to 150°C		-46°C to 200°C		-46°C to 200°C		-29°C to 150°C	
10. Material Class	Carbon Steel		Carbon Steel		Carbon Steel		Carbon Steel	
11. Body Material	ASTM A350 Gr LF2 CL1 + Inconel 625 weld overlay (acc. item A.7.1.7.3)		ASTM A350 Gr LF2 CL1 + Inconel 625 weld overlay (acc. item A.7.1.7.3)		ASTM A350 Gr LF2 CL1 + Inconel 625 weld overlay (acc. item A.7.1.7.3)		ASTM A105 + Inconel 625 weld overlay (acc. item A.7.1.7.3)	
12. Obturator Material	AISI 316 + Tungsten carbide coating		AISI 316 + Tungsten carbide coating		AISI 316 + Tungsten carbide coating		ASTM A105 + Inconel 625 weld overlay (acc. item A.7.1.7.3)	
13. Seat Material	AISI 316 + Tungsten carbide coating		AISI 316 + Tungsten carbide coating		AISI 316 + Tungsten carbide coating		ASTM A105 + Inconel 625 weld overlay (acc. item A.7.1.7.3)	
14. Seat Insert	N/A		N/A		N/A		PTFE reinforced with 25% Carbon	
15. Spring (Seat) Material	UNS N07750		UNS N07750		UNS N07750		UNS N07750	
16. Stem Material	ASTM A276 (UNS S31600)		ASTM A276 (UNS S31600)		ASTM A276 (UNS S31600)		ASTM B637 (UNS N07718)	
17. Seat-Stem Seal	Group B (acc. item A.7.1.5.6)		Group E (acc. item A.7.1.5.6)		Group E (acc. item A.7.1.5.6)		Group B (acc. item A.7.1.5.6)	
18. Operator Type	2" - 4"	Lever	2" - 4"	Lever	2" - 4"	Lever	2" - 4"	Lever
	6" - 30"	Gearbox	6" - 30"	Gearbox	6" - 30"	Gearbox	6" - 26"	Gearbox
19. Additional Requirement	Fire Tested (acc. item A.6.1.4)		N/A		Fire Tested (acc. item A.6.1.4)		Fire Tested (acc. item A.6.1.4)	
20. Seat Type	Side A: SPE / Side B: DPE; DIB-2 & DBB		Side A: SPE / Side B: DPE; DIB-2 & DBB		Side A: SPE / Side B: DPE; DIB-2 & DBB		Side A: SPE / Side B: DPE; DIB-2 & DBB	
21. Bore Type	Full Bore		Full Bore		Full Bore		Full Bore	
22. Body Construction	split body, bolted		split body, bolted		split body, bolted		split body, bolted	
23. Cladding or Coating	Partial clad - Inconel 625 weld overlay on all body sealing areas		Partial clad - Inconel 625 weld overlay on all body sealing areas		Partial clad - Inconel 625 weld overlay on all body sealing areas		Full clad - Inconel 625 weld overlay on all wetted parts	
24. Valve Testing	FAT according A.9.3		FAT according A.9.3		FAT according A.9.3		FAT according A.9.3	
25. Notes	Acceptance criteria for sealing tests see Annex A		Acceptance criteria for sealing tests see Annex A		Acceptance criteria for sealing tests see Annex A		N/A	

Valve Code	VES-300-3-C526		VES-300-3-C527		VES-300-3-C536		VES-300-3-C537	
Specs	C30		C30		C30		C30	
1. Valve Type	Ball		Ball		Ball		Ball	
2. Sealing Type	Soft		Soft		Soft		Soft	
3. Valve Specification Level (VSL)	VSL-3		VSL-3		VSL-3		VSL-3	
4. Ball Mouting	2" - 4"	Floating	2" - 4"	Floating	2" - 4"	Floating	2" - 4"	Floating
	6" - 26"	Trunnion	6" - 26"	Trunnion	6" - 26"	Trunnion	6" - 26"	Trunnion
5. Standard	API 6D / IOGP S-562		API 6D / IOGP S-562		API 6D / IOGP S-562		API 6D / IOGP S-562	
6. Size Range (NPS)	2" - 26"		2" - 26"		2" - 26"		2" - 26"	
7. End Connection	2" - 24"	ASME B16.5, RF	2" - 24"	ASME B16.5, RF	2" - 24"	ASME B16.5, RF	2" - 24"	ASME B16.5, RF
	26"	ASME B16.47 Series A, RF	26"	ASME B16.47 Series A, RF	26"	ASME B16.47 Series A, RF	26"	ASME B16.47 Series A, RF
8. Pressure Class	300		300		300		300	
9. Temperature	0°C to 150°C		0°C to 150°C		0°C to 150°C		0°C to 150°C	
10. Material Class	Carbon Steel		Carbon Steel		Carbon Steel		Carbon Steel	
11. Body Material	ASTM A105 + Inconel 625 weld overlay (acc. item A.7.1.7.3)		ASTM A105 + Inconel 625 weld overlay (acc. item A.7.1.7.3)		ASTM A105 + Inconel 625 weld overlay (acc. item A.7.1.7.3)		ASTM A105 + Inconel 625 weld overlay (acc. item A.7.1.7.3)	
12. Obturator Material	ASTM A105 + Inconel 625 weld overlay (acc. item A.7.1.7.3)		ASTM A105 + Inconel 625 weld overlay (acc. item A.7.1.7.3)		ASTM A105 + Inconel 625 weld overlay (acc. item A.7.1.7.3)		ASTM A105 + Inconel 625 weld overlay (acc. item A.7.1.7.3)	
13. Seat Material	ASTM A105 + Inconel 625 weld overlay (acc. item A.7.1.7.3)		ASTM A105 + Inconel 625 weld overlay (acc. item A.7.1.7.3)		ASTM A105 + Inconel 625 weld overlay (acc. item A.7.1.7.3)		ASTM A105 + Inconel 625 weld overlay (acc. item A.7.1.7.3)	
14. Seat Insert	PTFE reinforced with 25% Carbon		PTFE reinforced with 25% Carbon		PTFE reinforced with 25% Carbon		PTFE reinforced with 25% Carbon	
15. Spring (Seat) Material	UNS N07750		UNS N07750		UNS N07750		UNS N07750	
16. Stem Material	ASTM B637 (UNS N07718)		ASTM B637 (UNS N07718)		ASTM B637 (UNS N07718)		ASTM B637 (UNS N07718)	
17. Seat-Stem Seal	Group C (acc. item A.7.1.5.6)		Group C (acc. item A.7.1.5.6)		Group D (acc. item A.7.1.5.6)		Group D (acc. item A.7.1.5.6)	
18. Operator Type	2" - 4"	Lever	2" - 4"	Lever	2" - 4"	Lever	2" - 4"	Lever
	6" - 26"	Gearbox	6" - 26"	Gearbox	6" - 26"	Gearbox	6" - 26"	Gearbox
19. Additional Requirement	N/A		Fire Tested (acc. item A.6.1.4)		N/A		Fire Tested (acc. item A.6.1.4)	
20. Seat Type	Side A: SPE / Side B: DPE; DIB-2 & DBB		Side A: SPE / Side B: DPE; DIB-2 & DBB		Side A: SPE / Side B: DPE; DIB-2 & DBB		Side A: SPE / Side B: DPE; DIB-2 & DBB	
21. Bore Type	Full Bore		Full Bore		Full Bore		Full Bore	
22. Body Construction	split body, bolted		split body, bolted		split body, bolted		split body, bolted	
23. Cladding or Coating	Full clad - Inconel 625 weld overlay on all wetted parts		Full clad - Inconel 625 weld overlay on all wetted parts		Full clad - Inconel 625 weld overlay on all wetted parts		Full clad - Inconel 625 weld overlay on all wetted parts	
24. Valve Testing	FAT according A.9.3		FAT according A.9.3		FAT according A.9.3		FAT according A.9.3	
25. Notes	N/A		N/A		N/A		N/A	

Valve Code	VES-300-3-C553		VES-300-3-C562		VES-300-3-C563		VES-300-3-C572	
Specs	C30		C30		C30		C30	
1. Valve Type	Ball		Ball		Ball		Ball	
2. Sealing Type	Metal to Metal		Metal to Metal		Metal to Metal		Metal to Metal	
3. Valve Specification Level (VSL)	VSL-3		VSL-3		VSL-3		VSL-3	
4. Ball Mouting	2" - 4"	Floating	2" - 4"	Floating	2" - 4"	Floating	2" - 4"	Floating
	6" - 26"	Trunnion	6" - 26"	Trunnion	6" - 26"	Trunnion	6" - 26"	Trunnion
5. Standard	API 6D / IOGP S-562		API 6D		API 6D		API 6D	
6. Size Range (NPS)	2" - 26"		2" - 26"		2" - 26"		2" - 26"	
7. End Connection	2" - 24"	ASME B16.5, RF	2" - 24"	ASME B16.5, RF	2" - 24"	ASME B16.5, RF	2" - 24"	ASME B16.5, RF
	26"	ASME B16.47 Series A, RF	26"	ASME B16.47 Series A, RF	26"	ASME B16.47 Series A, RF	26"	ASME B16.47 Series A, RF
8. Pressure Class	300		300		300		300	
9. Temperature	-29°C to 150°C		0°C to 210°C		0°C to 210°C		0°C to 210°C	
10. Material Class	Carbon Steel		Carbon Steel		Carbon Steel		Carbon Steel	
11. Body Material	ASTM A105 + Inconel 625 weld overlay (acc. item A.7.1.7.3)		ASTM A105 + Inconel 625 weld overlay (acc. item A.7.1.7.3)		ASTM A105 + Inconel 625 weld overlay (acc. item A.7.1.7.3)		ASTM A105 + Inconel 625 weld overlay (acc. item A.7.1.7.3)	
12. Obturator Material	ASTM A105 + Inconel 625 weld overlay (acc. item A.7.1.7.3) + Tungsten carbide coating		ASTM A105 + Inconel 625 weld overlay (acc. item A.7.1.7.3) + Tungsten carbide coating		ASTM A105 + Inconel 625 weld overlay (acc. item A.7.1.7.3) + Tungsten carbide coating		ASTM A105 + Inconel 625 weld overlay (acc. item A.7.1.7.3) + Tungsten carbide coating	
13. Seat Material	ASTM A105 + Inconel 625 weld overlay (acc. item A.7.1.7.3) + Tungsten carbide coating		ASTM A105 + Inconel 625 weld overlay (acc. item A.7.1.7.3) + Tungsten carbide coating		ASTM A105 + Inconel 625 weld overlay (acc. item A.7.1.7.3) + Tungsten carbide coating		ASTM A105 + Inconel 625 weld overlay (acc. item A.7.1.7.3) + Tungsten carbide coating	
14. Seat Insert	N/A		N/A		N/A		N/A	
15. Spring (Seat) Material	UNS N07750		UNS N07750		UNS N07750		UNS N07750	
16. Stem Material	ASTM B637 (UNS N07718)		ASTM B637 (UNS N07718)		ASTM B637 (UNS N07718)		ASTM B637 (UNS N07718)	
17. Seat-Stem Seal	Group B (acc. item A.7.1.5.6)		Group C (acc. item A.7.1.5.6)		Group C (acc. item A.7.1.5.6)		Group D (acc. item A.7.1.5.6)	
18. Operator Type	2" - 4"	Lever	2" - 4"	Lever	2" - 4"	Lever	2" - 4"	Lever
	6" - 26"	Gearbox	6" - 26"	Gearbox	6" - 26"	Gearbox	6" - 26"	Gearbox
19. Additional Requirement	Fire Tested (acc. item A.6.1.4)		N/A		Fire Tested (acc. item A.6.1.4)		N/A	
20. Seat Type	Side A: SPE / Side B: DPE; DIB-2 & DBB		Side A: SPE / Side B: DPE; DIB-2 & DBB		Side A: SPE / Side B: DPE; DIB-2 & DBB		Side A: SPE / Side B: DPE; DIB-2 & DBB	
21. Bore Type	Full Bore		Full Bore		Full Bore		Full Bore	
22. Body Construction	split body, bolted		split body, bolted		split body, bolted		split body, bolted	
23. Cladding or Coating	Full clad - Inconel 625 weld overlay on all wetted parts		Full clad - Inconel 625 weld overlay on all wetted parts		Full clad - Inconel 625 weld overlay on all wetted parts		Full clad - Inconel 625 weld overlay on all wetted parts	
24. Valve Testing	FAT according A.9.3		FAT according A.9.3		FAT according A.9.3		FAT according A.9.3	
25. Notes	Acceptance criteria for sealing tests see Annex A		Acceptance criteria for sealing tests see Annex A		Acceptance criteria for sealing tests see Annex A		Acceptance criteria for sealing tests see Annex A	

Valve Code	VES-300-3-C573		VES-300-3-D216		VES-300-3-D217		VES-300-3-D226	
Specs	C30		C11 C16		C11 C16		C16	
1. Valve Type	Ball		Ball		Ball		Ball	
2. Sealing Type	Metal to Metal		Soft		Soft		Soft	
3. Valve Specification Level (VSL)	VSL-3		VSL-3		VSL-3		VSL-3	
4. Ball Mouting	2" - 4"	Floating	2" - 4"	Floating	2" - 4"	Floating	2" - 4"	Floating
	6" - 26"	Trunnion	6" - 24"	Trunnion	6" - 24"	Trunnion	6" - 24"	Trunnion
5. Standard	API 6D		API 6D / IOGP S-562		API 6D / IOGP S-562		API 6D / IOGP S-562	
6. Size Range (NPS)	2" - 26"		2" - 24"		2" - 24"		2" - 24"	
7. End Connection	2" - 24"	ASME B16.5, RF	ASME B16.5, RF		ASME B16.5, RF		ASME B16.5, RF	
	26"	ASME B16.47 Series A, RF	N/A		N/A		N/A	
8. Pressure Class	300		300		300		300	
9. Temperature	0°C to 210°C		-30°C to 150°C		-30°C to 150°C		0°C to 150°C	
10. Material Class	Carbon Steel		Duplex Steel		Duplex Steel		Duplex Steel	
11. Body Material	ASTM A105 + Inconel 625 weld overlay (acc. item A.7.1.7.3)		ASTM A182 Gr F51		ASTM A182 Gr F51		ASTM A182 Gr F51	
12. Obturator Material	ASTM A105 + Inconel 625 weld overlay (acc. item A.7.1.7.3) + Tungsten carbide coating		Duplex (UNS S31803)		Duplex (UNS S31803)		Duplex (UNS S31803)	
13. Seat Material	ASTM A105 + Inconel 625 weld overlay (acc. item A.7.1.7.3) + Tungsten carbide coating		Duplex (UNS S31803)		Duplex (UNS S31803)		Duplex (UNS S31803)	
14. Seat Insert	N/A		PTFE reinforced with 25% Carbon		PTFE reinforced with 25% Carbon		PTFE reinforced with 25% Carbon	
15. Spring (Seat) Material	UNS N07750		UNS N07750		UNS N07750		UNS N07750	
16. Stem Material	ASTM B637 (UNS N07718)		ASTM A276 (UNS S31803)		ASTM A276 (UNS S31803)		ASTM A276 (UNS S31803)	
17. Seat-Stem Seal	Group D (acc. item A.7.1.5.6)		Group B (acc. item A.7.1.5.6)		Group B (acc. item A.7.1.5.6)		Group C (acc. item A.7.1.5.6)	
18. Operator Type	2" - 4"	Lever	2" - 4"	Lever	2" - 4"	Lever	2" - 4"	Lever
	6" - 26"	Gearbox	6" - 24"	Gearbox	6" - 24"	Gearbox	6" - 24"	Gearbox
19. Additional Requirement	Fire Tested (acc. item A.6.1.4)		N/A		Fire Tested (acc. item A.6.1.4)		N/A	
20. Seat Type	Side A: SPE / Side B: DPE; DIB-2 & DBB		Side A: SPE / Side B: DPE; DIB-2 & DBB		Side A: SPE / Side B: DPE; DIB-2 & DBB		Side A: SPE / Side B: DPE; DIB-2 & DBB	
21. Bore Type	Full Bore		Full Bore		Full Bore		Full Bore	
22. Body Construction	split body, bolted		split body, bolted		split body, bolted		split body, bolted	
23. Cladding or Coating	Full clad - Inconel 625 weld overlay on all wetted parts		N/A		N/A		N/A	
24. Valve Testing	FAT according A.9.3		FAT according A.9.3		FAT according A.9.3		FAT according A.9.3	
25. Notes	Acceptance criteria for sealing tests see Annex A		N/A		N/A		N/A	

Valve Code	VES-300-3-D227		VES-300-3-D236		VES-300-3-D237		VES-300-3-D252	
Specs	C16		C16		C16		C16	
1. Valve Type	Ball		Ball		Ball		Ball	
2. Sealing Type	Soft		Soft		Soft		Metal to Metal	
3. Valve Specification Level (VSL)	VSL-3		VSL-3		VSL-3		VSL-3	
4. Ball Mouting	2" - 4"	Floating	2" - 4"	Floating	2" - 4"	Floating	2" - 4"	Floating
	6" - 24"	Trunnion	6" - 24"	Trunnion	6" - 24"	Trunnion	6" - 24"	Trunnion
5. Standard	API 6D / IOGP S-562		API 6D / IOGP S-562		API 6D / IOGP S-562		API 6D / IOGP S-562	
6. Size Range (NPS)	2" - 24"		2" - 24"		2" - 24"		2" - 24"	
7. End Connection	ASME B16.5, RF		ASME B16.5, RF		ASME B16.5, RF		ASME B16.5, RF	
8. Pressure Class	300		300		300		300	
9. Temperature	0°C to 150°C		-46°C to 150°C		-46°C to 150°C		-30°C to 150°C	
10. Material Class	Duplex Steel		Duplex Steel		Duplex Steel		Duplex Steel	
11. Body Material	ASTM A182 Gr F51		ASTM A182 Gr F51		ASTM A182 Gr F51		ASTM A182 Gr F51	
12. Obturator Material	Duplex (UNS S31803)		Duplex (UNS S31803)		Duplex (UNS S31803)		Duplex (UNS S31803) + Tungsten carbide coating	
13. Seat Material	Duplex (UNS S31803)		Duplex (UNS S31803)		Duplex (UNS S31803)		Duplex (UNS S31803) + Tungsten carbide coating	
14. Seat Insert	PTFE reinforced with 25% Carbon		PTFE reinforced with 25% Carbon		PTFE reinforced with 25% Carbon		N/A	
15. Spring (Seat) Material	UNS N07750		UNS N07750		UNS N07750		UNS N07750	
16. Stem Material	ASTM A276 (UNS S31803)		ASTM A276 (UNS S31803)		ASTM A276 (UNS S31803)		ASTM A276 (UNS S31803)	
17. Seat-Stem Seal	Group C (acc. item A.7.1.5.6)		Group E (acc. item A.7.1.5.6)		Group E (acc. item A.7.1.5.6)		Group B (acc. item A.7.1.5.6)	
18. Operator Type	2" - 4"	Lever	2" - 4"	Lever	2" - 4"	Lever	2" - 4"	Lever
	6" - 24"	Gearbox	6" - 24"	Gearbox	6" - 24"	Gearbox	6" - 24"	Gearbox
19. Additional Requirement	Fire Tested (acc. item A.6.1.4)		N/A		Fire Tested (acc. item A.6.1.4)		N/A	
20. Seat Type	Side A: SPE / Side B: DPE; DIB-2 & DBB		Side A: SPE / Side B: DPE; DIB-2 & DBB		Side A: SPE / Side B: DPE; DIB-2 & DBB		Side A: SPE / Side B: DPE; DIB-2 & DBB	
21. Bore Type	Full Bore		Full Bore		Full Bore		Full Bore	
22. Body Construction	split body, bolted		split body, bolted		split body, bolted		split body, bolted	
23. Cladding or Coating	N/A		N/A		N/A		N/A	
24. Valve Testing	FAT according A.9.3		FAT according A.9.3		FAT according A.9.3		FAT according A.9.3	
25. Notes	N/A		N/A		N/A		Acceptance criteria for sealing tests see Annex A	

Valve Code	VES-300-3-D253		VES-300-3-D262		VES-300-3-D263		VES-300-3-D272	
Specs	C16		C16		C16		C16	
1. Valve Type	Ball		Ball		Ball		Ball	
2. Sealing Type	Metal to Metal		Metal to Metal		Metal to Metal		Metal to Metal	
3. Valve Specification Level (VSL)	VSL-3		VSL-3		VSL-3		VSL-3	
4. Ball Mouting	2" - 4"	Floating	2" - 4"	Floating	2" - 4"	Floating	2" - 4"	Floating
	6" - 24"	Trunnion	6" - 24"	Trunnion	6" - 24"	Trunnion	6" - 24"	Trunnion
5. Standard	API 6D / IOGP S-562		API 6D / IOGP S-562		API 6D / IOGP S-562		API 6D / IOGP S-562	
6. Size Range (NPS)	2" - 24"		2" - 24"		2" - 24"		2" - 24"	
7. End Connection	ASME B16.5, RF		ASME B16.5, RF		ASME B16.5, RF		ASME B16.5, RF	
8. Pressure Class	300		300		300		300	
9. Temperature	-30°C to 150°C		0°C to 150°C		0°C to 150°C		-46°C to 150°C	
10. Material Class	Duplex Steel		Duplex Steel		Duplex Steel		Duplex Steel	
11. Body Material	ASTM A182 Gr F51		ASTM A182 Gr F51		ASTM A182 Gr F51		ASTM A182 Gr F51	
12. Obturator Material	Duplex (UNS S31803) + Tungsten carbide coating		Duplex (UNS S31803) + Tungsten carbide coating		Duplex (UNS S31803) + Tungsten carbide coating		Duplex (UNS S31803) + Tungsten carbide coating	
13. Seat Material	Duplex (UNS S31803) + Tungsten carbide coating		Duplex (UNS S31803) + Tungsten carbide coating		Duplex (UNS S31803) + Tungsten carbide coating		Duplex (UNS S31803) + Tungsten carbide coating	
14. Seat Insert	N/A		N/A		N/A		N/A	
15. Spring (Seat) Material	UNS N07750		UNS N07750		UNS N07750		UNS N07750	
16. Stem Material	ASTM A276 (UNS S31803)		ASTM A276 (UNS S31803)		ASTM A276 (UNS S31803)		ASTM A276 (UNS S31803)	
17. Seat-Stem Seal	Group B (acc. item A.7.1.5.6)		Group C (acc. item A.7.1.5.6)		Group C (acc. item A.7.1.5.6)		Group E (acc. item A.7.1.5.6)	
18. Operator Type	2" - 4"	Lever	2" - 4"	Lever	2" - 4"	Lever	2" - 4"	Lever
	6" - 24"	Gearbox	6" - 24"	Gearbox	6" - 24"	Gearbox	6" - 24"	Gearbox
19. Additional Requirement	Fire Tested (acc. item A.6.1.4)		N/A		Fire Tested (acc. item A.6.1.4)		N/A	
20. Seat Type	Side A: SPE / Side B: DPE; DIB-2 & DBB		Side A: SPE / Side B: DPE; DIB-2 & DBB		Side A: SPE / Side B: DPE; DIB-2 & DBB		Side A: SPE / Side B: DPE; DIB-2 & DBB	
21. Bore Type	Full Bore		Full Bore		Full Bore		Full Bore	
22. Body Construction	split body, bolted		split body, bolted		split body, bolted		split body, bolted	
23. Cladding or Coating	N/A		N/A		N/A		N/A	
24. Valve Testing	FAT according A.9.3		FAT according A.9.3		FAT according A.9.3		FAT according A.9.3	
25. Notes	Acceptance criteria for sealing tests see Annex A		Acceptance criteria for sealing tests see Annex A		Acceptance criteria for sealing tests see Annex A		Acceptance criteria for sealing tests see Annex A	

Valve Code	VES-300-3-D273		VES-300-3-D316		VES-300-3-D317		VES-300-3-D336	
Specs	C16		C12		C12		C12	
1. Valve Type	Ball		Ball		Ball		Ball	
2. Sealing Type	Metal to Metal		Soft		Soft		Soft	
3. Valve Specification Level (VSL)	VSL-3		VSL-3		VSL-3		VSL-3	
4. Ball Mouting	2" - 4"	Floating	2" - 4"	Floating	2" - 4"	Floating	2" - 4"	Floating
	6" - 24"	Trunnion	6" - 30"	Trunnion	6" - 30"	Trunnion	6" - 30"	Trunnion
5. Standard	API 6D / IOGP S-562		API 6D / IOGP S-562		API 6D / IOGP S-562		API 6D / IOGP S-562	
6. Size Range (NPS)	2" - 24"		2" - 30"		2" - 30"		2" - 30"	
7. End Connection	ASME B16.5, RF		2" - 24"	ASME B16.5, RF	2" - 24"	ASME B16.5, RF	2" - 24"	ASME B16.5, RF
	N/A		26" - 30"	ASME B16.47 Series A, RF	26" - 30"	ASME B16.47 Series A, RF	26" - 30"	ASME B16.47 Series A, RF
8. Pressure Class	300		300		300		300	
9. Temperature	-46°C to 150°C		-30°C to 150°C		-30°C to 150°C		0°C to 150°C	
10. Material Class	Duplex Steel		Duplex Steel		Duplex Steel		Duplex Steel	
11. Body Material	ASTM A182 Gr F51		ASTM A182 Gr F55		ASTM A182 Gr F55		ASTM A182 Gr F55	
12. Obturator Material	Duplex (UNS S31803) + Tungsten carbide coating		Super Duplex (UNS S32760)		Super Duplex (UNS S32760)		Super Duplex (UNS S32760)	
13. Seat Material	Duplex (UNS S31803) + Tungsten carbide coating		Super Duplex (UNS S32760)		Super Duplex (UNS S32760)		Super Duplex (UNS S32760)	
14. Seat Insert	N/A		PTFE reinforced with 25% Carbon		PTFE reinforced with 25% Carbon		PTFE reinforced with 25% Carbon	
15. Spring (Seat) Material	UNS N07750		UNS N07750		UNS N07750		UNS N07750	
16. Stem Material	ASTM A276 (UNS S31803)		ASTM A276 (UNS S32760)		ASTM A276 (UNS S32760)		ASTM A276 (UNS S32760)	
17. Seat-Stem Seal	Group E (acc. item A.7.1.5.6)		Group B (acc. item A.7.1.5.6)		Group B (acc. item A.7.1.5.6)		Group D (acc. item A.7.1.5.6)	
18. Operator Type	2" - 4"	Lever	2" - 4"	Lever	2" - 4"	Lever	2" - 4"	Lever
	6" - 24"	Gearbox	6" - 30"	Gearbox	6" - 30"	Gearbox	6" - 30"	Gearbox
19. Additional Requirement	Fire Tested (acc. item A.6.1.4)		N/A		Fire Tested (acc. item A.6.1.4)		N/A	
20. Seat Type	Side A: SPE / Side B: DPE; DIB-2 & DBB		Side A: SPE / Side B: DPE; DIB-2 & DBB		Side A: SPE / Side B: DPE; DIB-2 & DBB		Side A: SPE / Side B: DPE; DIB-2 & DBB	
21. Bore Type	Full Bore		Full Bore		Full Bore		Full Bore	
22. Body Construction	split body, bolted		split body, bolted		split body, bolted		split body, bolted	
23. Cladding or Coating	N/A		N/A		N/A		N/A	
24. Valve Testing	FAT according A.9.3		FAT according A.9.3		FAT according A.9.3		FAT according A.9.3	
25. Notes	Acceptance criteria for sealing tests see Annex A		N/A		N/A		N/A	

Valve Code	VES-300-3-D337		VES-300-3-D352		VES-300-3-D353		VES-300-3-D372	
Specs	C12		C12		C12		C12	
1. Valve Type	Ball		Ball		Ball		Ball	
2. Sealing Type	Soft		Metal to Metal		Metal to Metal		Metal to Metal	
3. Valve Specification Level (VSL)	VSL-3		VSL-3		VSL-3		VSL-3	
4. Ball Mouting	2" - 4"	Floating	2" - 4"	Floating	2" - 4"	Floating	2" - 4"	Floating
	6" - 30"	Trunnion	6" - 30"	Trunnion	6" - 30"	Trunnion	6" - 30"	Trunnion
5. Standard	API 6D / IOGP S-562		API 6D / IOGP S-562		API 6D / IOGP S-562		API 6D / IOGP S-562	
6. Size Range (NPS)	2" - 30"		2" - 30"		2" - 30"		2" - 30"	
7. End Connection	2" - 24"	ASME B16.5, RF	2" - 24"	ASME B16.5, RF	2" - 24"	ASME B16.5, RF	2" - 24"	ASME B16.5, RF
	26" - 30"	ASME B16.47 Series A, RF	26" - 30"	ASME B16.47 Series A, RF	26" - 30"	ASME B16.47 Series A, RF	26" - 30"	ASME B16.47 Series A, RF
8. Pressure Class	300		300		300		300	
9. Temperature	0°C to 150°C		0°C to 150°C		0°C to 150°C		0°C to 150°C	
10. Material Class	Duplex Steel		Duplex Steel		Duplex Steel		Duplex Steel	
11. Body Material	ASTM A182 Gr F55		ASTM A182 Gr F55		ASTM A182 Gr F55		ASTM A182 Gr F55	
12. Obturator Material	Super Duplex (UNS S32760)		Super Duplex (UNS S32760) + Tungsten carbide coating		Super Duplex (UNS S32760) + Tungsten carbide coating		Super Duplex (UNS S32760) + Tungsten carbide coating	
13. Seat Material	Super Duplex (UNS S32760)		Super Duplex (UNS S32760) + Tungsten carbide coating		Super Duplex (UNS S32760) + Tungsten carbide coating		Super Duplex (UNS S32760) + Tungsten carbide coating	
14. Seat Insert	PTFE reinforced with 25% Carbon		N/A		N/A		N/A	
15. Spring (Seat) Material	UNS N07750		UNS N07750		UNS N07750		UNS N07750	
16. Stem Material	ASTM A276 (UNS S32760)		ASTM A276 (UNS S32760)		ASTM A276 (UNS S32760)		ASTM A276 (UNS S32760)	
17. Seat-Stem Seal	Group D (acc. item A.7.1.5.6)		Group A (acc. item A.7.1.5.6)		Group A (acc. item A.7.1.5.6)		Group D (acc. item A.7.1.5.6)	
18. Operator Type	2" - 4"	Lever	2" - 4"	Lever	2" - 4"	Lever	2" - 4"	Lever
	6" - 30"	Gearbox	6" - 30"	Gearbox	6" - 30"	Gearbox	6" - 30"	Gearbox
19. Additional Requirement	Fire Tested (acc. item A.6.1.4)		N/A		Fire Tested (acc. item A.6.1.4)		N/A	
20. Seat Type	Side A: SPE / Side B: DPE; DIB-2 & DBB		Side A: SPE / Side B: DPE; DIB-2 & DBB		Side A: SPE / Side B: DPE; DIB-2 & DBB		Side A: SPE / Side B: DPE; DIB-2 & DBB	
21. Bore Type	Full Bore		Full Bore		Full Bore		Full Bore	
22. Body Construction	split body, bolted		split body, bolted		split body, bolted		split body, bolted	
23. Cladding or Coating	N/A		N/A		N/A		N/A	
24. Valve Testing	FAT according A.9.3		FAT according A.9.3		FAT according A.9.3		FAT according A.9.3	
25. Notes	N/A		Acceptance criteria for sealing tests see Annex A		Acceptance criteria for sealing tests see Annex A		Acceptance criteria for sealing tests see Annex A	

Valve Code	VES-300-3-D373		VES-300-3-S216		VES-300-3-S217		VES-300-3-S226	
Specs	C12		C3		C3		C3	
1. Valve Type	Ball		Ball		Ball		Ball	
2. Sealing Type	Metal to Metal		Soft		Soft		Soft	
3. Valve Specification Level (VSL)	VSL-3		VSL-3		VSL-3		VSL-3	
4. Ball Mouting	2" - 4"	Floating	2" - 4"	Floating	2" - 4"	Floating	2" - 4"	Floating
	6" - 30"	Trunnion	6" - 30"	Trunnion	6" - 30"	Trunnion	6" - 30"	Trunnion
5. Standard	API 6D / IOGP S-562		API 6D / IOGP S-562		API 6D / IOGP S-562		API 6D / IOGP S-562	
6. Size Range (NPS)	2" - 30"		2" - 30"		2" - 30"		2" - 30"	
7. End Connection	2" - 24"	ASME B16.5, RF	2" - 24"	ASME B16.5, RF	2" - 24"	ASME B16.5, RF	2" - 24"	ASME B16.5, RF
	26" - 30"	ASME B16.47 Series A, RF	26" - 30"	ASME B16.47 Series A, RF	26" - 30"	ASME B16.47 Series A, RF	26" - 30"	ASME B16.47 Series A, RF
8. Pressure Class	300		300		300		300	
9. Temperature	0°C to 150°C		-30°C to 150°C		-30°C to 150°C		0°C to 150°C	
10. Material Class	Duplex Steel		Stainless Steel		Stainless Steel		Stainless Steel	
11. Body Material	ASTM A182 Gr F55		ASTM A182 Gr F316		ASTM A182 Gr F316		ASTM A182 Gr F316	
12. Obturator Material	Super Duplex (UNS S32760) + Tungsten carbide coating		AISI 316		AISI 316		AISI 316	
13. Seat Material	Super Duplex (UNS S32760) + Tungsten carbide coating		AISI 316		AISI 316		AISI 316	
14. Seat Insert	N/A		PTFE reinforced with 25% Carbon		PTFE reinforced with 25% Carbon		PTFE reinforced with 25% Carbon	
15. Spring (Seat) Material	UNS N07750		UNS N07750		UNS N07750		UNS N07750	
16. Stem Material	ASTM A276 (UNS S32760)		ASTM A276 (UNS S31600)		ASTM A276 (UNS S31600)		ASTM A276 (UNS S31600)	
17. Seat-Stem Seal	Group D (acc. item A.7.1.5.6)		Group B (acc. item A.7.1.5.6)		Group B (acc. item A.7.1.5.6)		Group C (acc. item A.7.1.5.6)	
18. Operator Type	2" - 4"	Lever	2" - 4"	Lever	2" - 4"	Lever	2" - 4"	Lever
	6" - 30"	Gearbox	6" - 30"	Gearbox	6" - 30"	Gearbox	6" - 30"	Gearbox
19. Additional Requirement	Fire Tested (acc. item A.6.1.4)		N/A		Fire Tested (acc. item A.6.1.4)		N/A	
20. Seat Type	Side A: SPE / Side B: DPE; DIB-2 & DBB		Side A: SPE / Side B: DPE; DIB-2 & DBB		Side A: SPE / Side B: DPE; DIB-2 & DBB		Side A: SPE / Side B: DPE; DIB-2 & DBB	
21. Bore Type	Full Bore		Full Bore		Full Bore		Full Bore	
22. Body Construction	split body, bolted		split body, bolted		split body, bolted		split body, bolted	
23. Cladding or Coating	N/A		N/A		N/A		N/A	
24. Valve Testing	FAT according A.9.3		FAT according A.9.3		FAT according A.9.3		FAT according A.9.3	
25. Notes	Acceptance criteria for sealing tests see Annex A		N/A		N/A		N/A	

Valve Code	VES-300-3-S227		VES-300-3-S236		VES-300-3-S237		VES-300-3-S252	
Specs	C3		C3		C3		C3	
1. Valve Type	Ball		Ball		Ball		Ball	
2. Sealing Type	Soft		Soft		Soft		Metal to Metal	
3. Valve Specification Level (VSL)	VSL-3		VSL-3		VSL-3		VSL-3	
4. Ball Mouting	2" - 4"	Floating	2" - 4"	Floating	2" - 4"	Floating	2" - 4"	Floating
	6" - 30"	Trunnion	6" - 30"	Trunnion	6" - 30"	Trunnion	6" - 30"	Trunnion
5. Standard	API 6D / IOGP S-562		API 6D / IOGP S-562		API 6D / IOGP S-562		API 6D / IOGP S-562	
6. Size Range (NPS)	2" - 30"		2" - 30"		2" - 30"		2" - 30"	
7. End Connection	2" - 24"	ASME B16.5, RF	2" - 24"	ASME B16.5, RF	2" - 24"	ASME B16.5, RF	2" - 24"	ASME B16.5, RF
	26" - 30"	ASME B16.47 Series A, RF	26" - 30"	ASME B16.47 Series A, RF	26" - 30"	ASME B16.47 Series A, RF	26" - 30"	ASME B16.47 Series A, RF
8. Pressure Class	300		300		300		300	
9. Temperature	0°C to 150°C		-46°C to 150°C		-46°C to 150°C		-30°C to 150°C	
10. Material Class	Stainless Steel		Stainless Steel		Stainless Steel		Stainless Steel	
11. Body Material	ASTM A182 Gr F316		ASTM A182 Gr F316		ASTM A182 Gr F316		ASTM A182 Gr F316	
12. Obturator Material	AISI 316		AISI 316		AISI 316		AISI 316 + Tungsten carbide coating	
13. Seat Material	AISI 316		AISI 316		AISI 316		AISI 316 + Tungsten carbide coating	
14. Seat Insert	PTFE reinforced with 25% Carbon		PTFE reinforced with 25% Carbon		PTFE reinforced with 25% Carbon		N/A	
15. Spring (Seat) Material	UNS N07750		UNS N07750		UNS N07750		UNS N07750	
16. Stem Material	ASTM A276 (UNS S31600)		ASTM A276 (UNS S31600)		ASTM A276 (UNS S31600)		ASTM A276 (UNS S31600)	
17. Seat-Stem Seal	Group C (acc. item A.7.1.5.6)		Group E (acc. item A.7.1.5.6)		Group E (acc. item A.7.1.5.6)		Group B (acc. item A.7.1.5.6)	
18. Operator Type	2" - 4"	Lever	2" - 4"	Lever	2" - 4"	Lever	2" - 4"	Lever
	6" - 30"	Gearbox	6" - 30"	Gearbox	6" - 30"	Gearbox	6" - 30"	Gearbox
19. Additional Requirement	Fire Tested (acc. item A.6.1.4)		N/A		Fire Tested (acc. item A.6.1.4)		N/A	
20. Seat Type	Side A: SPE / Side B: DPE; DIB-2 & DBB		Side A: SPE / Side B: DPE; DIB-2 & DBB		Side A: SPE / Side B: DPE; DIB-2 & DBB		Side A: SPE / Side B: DPE; DIB-2 & DBB	
21. Bore Type	Full Bore		Full Bore		Full Bore		Full Bore	
22. Body Construction	split body, bolted		split body, bolted		split body, bolted		split body, bolted	
23. Cladding or Coating	N/A		N/A		N/A		N/A	
24. Valve Testing	FAT according A.9.3		FAT according A.9.3		FAT according A.9.3		FAT according A.9.3	
25. Notes	N/A		N/A		N/A		Acceptance criteria for sealing tests see Annex A	

Valve Code	VES-300-3-S253		VES-300-3-S262		VES-300-3-S263		VES-300-3-S272	
Specs	C3		C3		C3		C3	
1. Valve Type	Ball		Ball		Ball		Ball	
2. Sealing Type	Metal to Metal		Metal to Metal		Metal to Metal		Metal to Metal	
3. Valve Specification Level (VSL)	VSL-3		VSL-3		VSL-3		VSL-3	
4. Ball Mouting	2" - 4"	Floating	2" - 4"	Floating	2" - 4"	Floating	2" - 4"	Floating
	6" - 30"	Trunnion	6" - 30"	Trunnion	6" - 30"	Trunnion	6" - 30"	Trunnion
5. Standard	API 6D / IOGP S-562		API 6D		API 6D		API 6D	
6. Size Range (NPS)	2" - 30"		2" - 30"		2" - 30"		2" - 30"	
7. End Connection	2" - 24"	ASME B16.5, RF	2" - 24"	ASME B16.5, RF	2" - 24"	ASME B16.5, RF	2" - 24"	ASME B16.5, RF
	26" - 30"	ASME B16.47 Series A, RF	26" - 30"	ASME B16.47 Series A, RF	26" - 30"	ASME B16.47 Series A, RF	26" - 30"	ASME B16.47 Series A, RF
8. Pressure Class	300		300		300		300	
9. Temperature	-30°C to 150°C		0°C to 210°C		0°C to 210°C		-100°C to 200°C	
10. Material Class	Stainless Steel		Stainless Steel		Stainless Steel		Stainless Steel	
11. Body Material	ASTM A182 Gr F316		ASTM A182 Gr F316		ASTM A182 Gr F316		ASTM A182 Gr F316	
12. Obturator Material	AISI 316 + Tungsten carbide coating		AISI 316 + Tungsten carbide coating		AISI 316 + Tungsten carbide coating		AISI 316 + Tungsten carbide coating	
13. Seat Material	AISI 316 + Tungsten carbide coating		AISI 316 + Tungsten carbide coating		AISI 316 + Tungsten carbide coating		AISI 316 + Tungsten carbide coating	
14. Seat Insert	N/A		N/A		N/A		N/A	
15. Spring (Seat) Material	UNS N07750		UNS N07750		UNS N07750		UNS N07750	
16. Stem Material	ASTM A276 (UNS S31600)		ASTM A276 (UNS S31600)		ASTM A276 (UNS S31600)		ASTM A276 (UNS S31600)	
17. Seat-Stem Seal	Group B (acc. item A.7.1.5.6)		Group C (acc. item A.7.1.5.6)		Group C (acc. item A.7.1.5.6)		Group E (acc. item A.7.1.5.6)	
18. Operator Type	2" - 4"	Lever	2" - 4"	Lever	2" - 4"	Lever	2" - 4"	Lever
	6" - 30"	Gearbox	6" - 30"	Gearbox	6" - 30"	Gearbox	6" - 30"	Gearbox
19. Additional Requirement	Fire Tested (acc. item A.6.1.4)		N/A		Fire Tested (acc. item A.6.1.4)		N/A	
20. Seat Type	Side A: SPE / Side B: DPE; DIB-2 & DBB		Side A: SPE / Side B: DPE; DIB-2 & DBB		Side A: SPE / Side B: DPE; DIB-2 & DBB		Side A: SPE / Side B: DPE; DIB-2 & DBB	
21. Bore Type	Full Bore		Full Bore		Full Bore		Full Bore	
22. Body Construction	split body, bolted		split body, bolted		split body, bolted		split body, bolted	
23. Cladding or Coating	N/A		N/A		N/A		N/A	
24. Valve Testing	FAT according A.9.3		FAT according A.9.3		FAT according A.9.3		FAT according A.9.3	
25. Notes	Acceptance criteria for sealing tests see Annex A		Acceptance criteria for sealing tests see Annex A		Acceptance criteria for sealing tests see Annex A		Acceptance criteria for sealing tests see Annex A	

Valve Code	VES-300-3-S273		VES-300-4-C154		VES-300-4-C164		VES-300-4-C174	
Specs	C3		C9 C10		C9 C10		C9 C10	
1. Valve Type	Ball		Ball		Ball		Ball	
2. Sealing Type	Metal to Metal		Metal to Metal		Metal to Metal		Metal to Metal	
3. Valve Specification Level (VSL)	VSL-3		VSL-4		VSL-4		VSL-4	
4. Ball Mouting	2" - 4"	Floating	2" - 4"	Floating	2" - 4"	Floating	2" - 4"	Floating
	6" - 30"	Trunnion	6" - 32"	Trunnion	6" - 32"	Trunnion	6" - 32"	Trunnion
5. Standard	API 6D		API 6D / IOGP S-562		API 6D		API 6D	
6. Size Range (NPS)	2" - 30"		2" - 32"		2" - 32"		2" - 32"	
7. End Connection	2" - 24"	ASME B16.5, RF	2" - 24"	ASME B16.5, RF	2" - 24"	ASME B16.5, RF	2" - 24"	ASME B16.5, RF
	26" - 30"	ASME B16.47 Series A, RF	26" - 32"	ASME B16.47 Series A, RF	26" - 32"	ASME B16.47 Series A, RF	26" - 32"	ASME B16.47 Series A, RF
8. Pressure Class	300		300		300		300	
9. Temperature	-100°C to 200°C		0°C to 150°C		0°C to 210°C		0°C to 210°C	
10. Material Class	Stainless Steel		Carbon Steel		Carbon Steel		Carbon Steel	
11. Body Material	ASTM A182 Gr F316		ASTM A105 + SS316 weld overlay (acc. item A.7.1.7.3)		ASTM A105 + SS316 weld overlay (acc. item A.7.1.7.3)		ASTM A105 + SS316 weld overlay (acc. item A.7.1.7.3)	
12. Obturator Material	AISI 316 + Tungsten carbide coating		AISI 410 + Tungsten carbide coating		AISI 410 + Tungsten carbide coating		AISI 410 + Tungsten carbide coating	
13. Seat Material	AISI 316 + Tungsten carbide coating		AISI 410 + Tungsten carbide coating		AISI 410 + Tungsten carbide coating		AISI 410 + Tungsten carbide coating	
14. Seat Insert	N/A		N/A		N/A		N/A	
15. Spring (Seat) Material	UNS N07750		UNS N07750		UNS N07750		UNS N07750	
16. Stem Material	ASTM A276 (UNS S31600)		ASTM A276 (UNS S41000)		ASTM A276 (UNS S41000)		ASTM A276 (UNS S41000)	
17. Seat-Stem Seal	Group E (acc. item A.7.1.5.6)		Group A (acc. item A.7.1.5.6)		Group C (acc. item A.7.1.5.6)		Group D (acc. item A.7.1.5.6)	
18. Operator Type	2" - 4"	Lever	Actuated		Actuated		Actuated	
	6" - 30"	Gearbox	N/A		N/A		N/A	
19. Additional Requirement	Fire Tested (acc. item A.6.1.4)		Fire Tested (acc. item A.6.1.4)		Fire Tested (acc. item A.6.1.4)		Fire Tested (acc. item A.6.1.4)	
20. Seat Type	Side A: SPE / Side B: DPE; DIB-2 & DBB		Side A: SPE / Side B: DPE; DIB-2 & DBB (notes)		Side A: SPE / Side B: DPE; DIB-2 & DBB (notes)		Side A: SPE / Side B: DPE; DIB-2 & DBB (notes)	
21. Bore Type	Full Bore		Full Bore		Full Bore		Full Bore	
22. Body Construction	split body, bolted		split body, bolted		split body, bolted		split body, bolted	
23. Cladding or Coating	N/A		Partial clad - SS316 weld overlay on all body sealing areas		Partial clad - SS316 weld overlay on all body sealing areas		Partial clad - SS316 weld overlay on all body sealing areas	
24. Valve Testing	FAT according A.9.3		FAT according A.9.3		FAT according A.9.3		FAT according A.9.3	
25. Notes	Acceptance criteria for sealing tests see Annex A		Acceptance criteria for sealing tests see Annex A, DBB tests to be performed at both conditions, fully opened and closed, Vent and drain connections according Annex A		Acceptance criteria for sealing tests see Annex A, DBB tests to be performed at both conditions, fully opened and closed, Vent and drain connections according Annex A		Acceptance criteria for sealing tests see Annex A, DBB tests to be performed at both conditions, fully opened and closed, Vent and drain connections according Annex A	

Valve Code	VES-300-4-C184		VES-300-4-D254	VES-300-4-D264	VES-300-4-D274
Specs	C9 C10		C16	C16	C16
1. Valve Type	Ball		Ball	Ball	Ball
2. Sealing Type	Metal to Metal		Metal to Metal	Metal to Metal	Metal to Metal
3. Valve Specification Level (VSL)	VSL-4		VSL-4	VSL-4	VSL-4
4. Ball Mouting	2" - 4"	Floating	Trunnion	Trunnion	Trunnion
	6" - 32"	Trunnion	N/A	N/A	N/A
5. Standard	API 6D		API 6D / IOGP S-562	API 6D / IOGP S-562	API 6D / IOGP S-562
6. Size Range (NPS)	2" - 32"		6" - 24"	6" - 24"	6" - 24"
7. End Connection	2" - 24"	ASME B16.5, RF	ASME B16.5, RF	ASME B16.5, RF	ASME B16.5, RF
	26" - 32"	ASME B16.47 Series A, RF	N/A	N/A	N/A
8. Pressure Class	300		300	300	300
9. Temperature	0°C to 400°C		-30°C to 150°C	0°C to 150°C	-46°C to 150°C
10. Material Class	Carbon Steel		Duplex Steel	Duplex Steel	Duplex Steel
11. Body Material	ASTM A105 + SS316 weld overlay (acc. item A.7.1.7.3)		ASTM A182 Gr F51	ASTM A182 Gr F51	ASTM A182 Gr F51
12. Obturator Material	AISI 410 + Chrome-Nickel Spray and Fuse (acc. Item A.8.2.2.4)		Duplex (UNS S31803) + Tungsten carbide coating	Duplex (UNS S31803) + Tungsten carbide coating	Duplex (UNS S31803) + Tungsten carbide coating
13. Seat Material	AISI 410 + Chrome-Nickel Spray and Fuse (acc. Item A.8.2.2.4)		Duplex (UNS S31803) + Tungsten carbide coating	Duplex (UNS S31803) + Tungsten carbide coating	Duplex (UNS S31803) + Tungsten carbide coating
14. Seat Insert	N/A		N/A	N/A	N/A
15. Spring (Seat) Material	UNS N07750		UNS N07750	UNS N07750	UNS N07750
16. Stem Material	ASTM A276 (UNS S41000)		ASTM A276 (UNS S31803)	ASTM A276 (UNS S31803)	ASTM A276 (UNS S31803)
17. Seat-Stem Seal	Group F (acc. item A.7.1.5.6)		Group B (acc. item A.7.1.5.6)	Group C (acc. item A.7.1.5.6)	Group E (acc. item A.7.1.5.6)
18. Operator Type	Actuated		Actuated	Actuated	Actuated
19. Additional Requirement	Fire Tested (acc. item A.6.1.4)		Fire Tested (acc. item A.6.1.4)	Fire Tested (acc. item A.6.1.4)	Fire Tested (acc. item A.6.1.4)
20. Seat Type	Side A: SPE / Side B: DPE; DIB-2 & DBB (notes)		Side A: SPE / Side B: DPE; DIB-2 & DBB (notes)	Side A: SPE / Side B: DPE; DIB-2 & DBB (notes)	Side A: SPE / Side B: DPE; DIB-2 & DBB (notes)
21. Bore Type	Full Bore		Full Bore	Full Bore	Full Bore
22. Body Construction	split body, bolted		split body, bolted	split body, bolted	split body, bolted
23. Cladding or Coating	Partial clad - SS316 weld overlay on all body sealing areas		N/A	N/A	N/A
24. Valve Testing	FAT according A.9.3		FAT according A.9.3	FAT according A.9.3	FAT according A.9.3
25. Notes	Acceptance criteria for sealing tests see Annex A, DBB tests to be performed at both conditions, fully opened and closed, Vent and drain connections according Annex A		Acceptance criteria for sealing tests see Annex A, DBB tests to be performed at both conditions, fully opened and closed, Vent and drain connections according Annex A	Acceptance criteria for sealing tests see Annex A, DBB tests to be performed at both conditions, fully opened and closed, Vent and drain connections according Annex A	Acceptance criteria for sealing tests see Annex A, DBB tests to be performed at both conditions, fully opened and closed, Vent and drain connections according Annex A

Valve Code	VES-300-4-D354		VES-300-4-D374		VES-600-1-A534		VES-600-1-C114	
Specs	C12		C12		E32		E9 E10	
1. Valve Type	Ball		Ball		Ball		Ball	
2. Sealing Type	Metal to Metal		Metal to Metal		Soft		Soft	
3. Valve Specification Level (VSL)	VSL-4		VSL-4		VSL-1		VSL-1	
4. Ball Mouting	Trunnion		Trunnion		Trunnion		Trunnion	
5. Standard	API 6D / IOGP S-562		API 6D / IOGP S-562		API 6D / IOGP S-562		API 6D / IOGP S-562	
6. Size Range (NPS)	6" - 30"		6" - 30"		2" - 4"		2" - 24"	
7. End Connection	6" - 24"	ASME B16.5, RF	6" - 24"	ASME B16.5, RF	ASME B16.5, RF		ASME B16.5, RF	
	26" - 30"	ASME B16.47 Series A, RF	26" - 30"	ASME B16.47 Series A, RF	N/A		N/A	
8. Pressure Class	300		300		600		600	
9. Temperature	0°C to 150°C		0°C to 150°C		-46°C to 150°C		-29°C to 150°C	
10. Material Class	Duplex Steel		Duplex Steel		Alloy Steel		Carbon Steel	
11. Body Material	ASTM A182 Gr F55		ASTM A182 Gr F55		ASTM A350 Gr LF3 or ASTM A352 Gr LC3 + Inconel 625 weld overlay (acc. item A.7.1.7.3)		ASTM A105 or ASTM A216 Gr WCB + SS316 weld overlay (acc. item A.7.1.7.3)	
12. Obturator Material	Super Duplex (UNS S32760) + Tungsten carbide coating		Super Duplex (UNS S32760) + Tungsten carbide coating		ASTM A350 Gr LF3 + Inconel 625 weld overlay (acc. item A.7.1.7.3)		AISI 410	
13. Seat Material	Super Duplex (UNS S32760) + Tungsten carbide coating		Super Duplex (UNS S32760) + Tungsten carbide coating		ASTM A350 Gr LF3 + Inconel 625 weld overlay (acc. item A.7.1.7.3)		AISI 410	
14. Seat Insert	N/A		N/A		PEEK		PEEK	
15. Spring (Seat) Material	UNS N07750		UNS N07750		UNS N07750		UNS N07750	
16. Stem Material	ASTM A276 (UNS S32760)		ASTM A276 (UNS S32760)		ASTM B637 (UNS N07718)		ASTM A276 (UNS S41000)	
17. Seat-Stem Seal	Group A (acc. item A.7.1.5.6)		Group D (acc. item A.7.1.5.6)		Group E (acc. item A.7.1.5.6)		Group B (acc. item A.7.1.5.6)	
18. Operator Type	Actuated		Actuated		2" - 3"	Lever	2" - 3"	Lever
	N/A		N/A		4"	Gearbox	4" - 24"	Gearbox
19. Additional Requirement	Fire Tested (acc. item A.6.1.4)		Fire Tested (acc. item A.6.1.4)		N/A		N/A	
20. Seat Type	Side A: SPE / Side B: DPE; DIB-2 & DBB (notes)		Side A: SPE / Side B: DPE; DIB-2 & DBB (notes)		Side A: SPE / Side B: SPE; DBB		Side A: SPE / Side B: SPE; DBB	
21. Bore Type	Full Bore		Full Bore		Full Bore		Full Bore	
22. Body Construction	split body, bolted		split body, bolted		split body, bolted		split body, bolted	
23. Cladding or Coating	N/A		N/A		Full clad - Inconel 625 weld overlay on all wetted parts		Partial clad - SS316 weld overlay on all body sealing areas	
24. Valve Testing	FAT according A.9.3		FAT according A.9.3		FAT according A.9.3		FAT according A.9.3	
25. Notes	Acceptance criteria for sealing tests see Annex A, DBB tests to be performed at both conditions, fully opened and closed, Vent and drain connections according Annex A		Acceptance criteria for sealing tests see Annex A, DBB tests to be performed at both conditions, fully opened and closed, Vent and drain connections according Annex A		N/A		N/A	

Valve Code	VES-600-1-C124		VES-600-1-C134		VES-600-1-C150		VES-600-1-C160	
Specs	E10		E9 E10		E9 E10		E10	
1. Valve Type	Ball		Ball		Ball		Ball	
2. Sealing Type	Soft		Soft		Metal to Metal		Metal to Metal	
3. Valve Specification Level (VSL)	VSL-1		VSL-1		VSL-1		VSL-1	
4. Ball Mouting	Trunnion		Trunnion		Trunnion		Trunnion	
5. Standard	API 6D / IOGP S-562		API 6D / IOGP S-562		API 6D / IOGP S-562		API 6D	
6. Size Range (NPS)	2" - 24"		2" - 24"		2" - 24"		2" - 24"	
7. End Connection	ASME B16.5, RF		ASME B16.5, RF		ASME B16.5, RF		ASME B16.5, RF	
8. Pressure Class	600		600		600		600	
9. Temperature	0°C to 150°C		0°C to 150°C		0°C to 150°C		0°C to 210°C	
10. Material Class	Carbon Steel		Carbon Steel		Carbon Steel		Carbon Steel	
11. Body Material	ASTM A105 or ASTM A216 Gr WCB + SS316 weld overlay (acc. item A.7.1.7.3)		ASTM A105 or ASTM A216 Gr WCB + SS316 weld overlay (acc. item A.7.1.7.3)		ASTM A105 or ASTM A216 Gr WCB + SS316 weld overlay (acc. item A.7.1.7.3)		ASTM A105 or ASTM A216 Gr WCB + SS316 weld overlay (acc. item A.7.1.7.3)	
12. Obturator Material	AISI 410		AISI 410		AISI 410 + Tungsten carbide coating		AISI 410 + Tungsten carbide coating	
13. Seat Material	AISI 410		AISI 410		AISI 410 + Tungsten carbide coating		AISI 410 + Tungsten carbide coating	
14. Seat Insert	PEEK		PEEK		N/A		N/A	
15. Spring (Seat) Material	UNS N07750		UNS N07750		UNS N07750		UNS N07750	
16. Stem Material	ASTM A276 (UNS S41000)		ASTM A276 (UNS S41000)		ASTM A276 (UNS S41000)		ASTM A276 (UNS S41000)	
17. Seat-Stem Seal	Group C (acc. item A.7.1.5.6)		Group D (acc. item A.7.1.5.6)		Group A (acc. item A.7.1.5.6)		Group C (acc. item A.7.1.5.6)	
18. Operator Type	2" - 3"	Lever	2" - 3"	Lever	2" - 3"	Lever	2" - 3"	Lever
	4" - 24"	Gearbox	4" - 24"	Gearbox	4" - 24"	Gearbox	4" - 24"	Gearbox
19. Additional Requirement	N/A		N/A		N/A		N/A	
20. Seat Type	Side A: SPE / Side B: SPE; DBB		Side A: SPE / Side B: SPE; DBB		Side A: SPE / Side B: SPE		Side A: SPE / Side B: SPE	
21. Bore Type	Full Bore		Full Bore		Full Bore		Full Bore	
22. Body Construction	split body, bolted		split body, bolted		split body, bolted		split body, bolted	
23. Cladding or Coating	Partial clad - SS316 weld overlay on all body sealing areas		Partial clad - SS316 weld overlay on all body sealing areas		Partial clad - SS316 weld overlay on all body sealing areas		Partial clad - SS316 weld overlay on all body sealing areas	
24. Valve Testing	FAT according A.9.3		FAT according A.9.3		FAT according A.9.3		FAT according A.9.3	
25. Notes	N/A		N/A		N/A		N/A	

Valve Code	VES-600-1-C170		VES-600-1-C214		VES-600-1-C234		VES-600-1-C524	
Specs	E9 E10		E6 E19		E6 E19		E30	
1. Valve Type	Ball		Ball		Ball		Ball	
2. Sealing Type	Metal to Metal		Soft		Soft		Soft	
3. Valve Specification Level (VSL)	VSL-1		VSL-1		VSL-1		VSL-1	
4. Ball Mouting	Trunnion		Trunnion		Trunnion		Trunnion	
5. Standard	API 6D		API 6D / IOGP S-562		API 6D / IOGP S-562		API 6D / IOGP S-562	
6. Size Range (NPS)	2" - 24"		2" - 24"		2" - 24"		2" - 4"	
7. End Connection	ASME B16.5, RF		ASME B16.5, RF		ASME B16.5, RF		ASME B16.5, RF	
8. Pressure Class	600		600		600		600	
9. Temperature	0°C to 210°C		-30°C to 150°C		-46°C to 150°C		0°C to 150°C	
10. Material Class	Carbon Steel		Carbon Steel		Carbon Steel		Carbon Steel	
11. Body Material	ASTM A105 or ASTM A216 Gr WCB + SS316 weld overlay (acc. item A.7.1.7.3)		ASTM A350 Gr LF2 CL1 or ASTM A352 Gr LCB + Inconel 625 weld overlay (acc. item A.7.1.7.3)		ASTM A350 Gr LF2 CL1 or ASTM A352 Gr LCB + Inconel 625 weld overlay (acc. item A.7.1.7.3)		ASTM A105 or ASTM A216 Gr WCB + Inconel 625 weld overlay (acc. item A.7.1.7.3)	
12. Obturator Material	AISI 410 + Tungsten carbide coating		AISI 316		AISI 316		ASTM A105 + Inconel 625 weld overlay (acc. item A.7.1.7.3)	
13. Seat Material	AISI 410 + Tungsten carbide coating		AISI 316		AISI 316		ASTM A105 + Inconel 625 weld overlay (acc. item A.7.1.7.3)	
14. Seat Insert	N/A		PEEK		PEEK		PEEK	
15. Spring (Seat) Material	UNS N07750		UNS N07750		UNS N07750		UNS N07750	
16. Stem Material	ASTM A276 (UNS S41000)		ASTM A276 (UNS S31600)		ASTM A276 (UNS S31600)		ASTM B637 (UNS N07718)	
17. Seat-Stem Seal	Group D (acc. item A.7.1.5.6)		Group B (acc. item A.7.1.5.6)		Group E (acc. item A.7.1.5.6)		Group C (acc. item A.7.1.5.6)	
18. Operator Type	2" - 3"	Lever	2" - 3"	Lever	2" - 3"	Lever	2" - 3"	Lever
	4" - 24"	Gearbox	4" - 24"	Gearbox	4" - 24"	Gearbox	4"	Gearbox
19. Additional Requirement	N/A		N/A		N/A		N/A	
20. Seat Type	Side A: SPE / Side B: SPE		Side A: SPE / Side B: SPE; DBB		Side A: SPE / Side B: SPE; DBB		Side A: SPE / Side B: SPE; DBB	
21. Bore Type	Full Bore		Full Bore		Full Bore		Full Bore	
22. Body Construction	split body, bolted		split body, bolted		split body, bolted		split body, bolted	
23. Cladding or Coating	Partial clad - SS316 weld overlay on all body sealing areas		Partial clad - Inconel 625 weld overlay on all body sealing areas		Partial clad - Inconel 625 weld overlay on all body sealing areas		Full clad - Inconel 625 weld overlay on all wetted parts	
24. Valve Testing	FAT according A.9.3		FAT according A.9.3		FAT according A.9.3		FAT according A.9.3	
25. Notes	N/A		N/A		N/A		N/A	

Valve Code	VES-600-1-C534		VES-600-1-C560		VES-600-1-C570		VES-600-1-C580	
Specs	E30		E30		E30		E30	
1. Valve Type	Ball		Ball		Ball		Ball	
2. Sealing Type	Soft		Metal to Metal		Metal to Metal		Metal to Metal	
3. Valve Specification Level (VSL)	VSL-1		VSL-1		VSL-1		VSL-1	
4. Ball Mouting	Trunnion		Trunnion		Trunnion		Trunnion	
5. Standard	API 6D / IOGP S-562		API 6D		API 6D		API 6D	
6. Size Range (NPS)	2" - 4"		2" - 4"		2" - 4"		2" - 4"	
7. End Connection	ASME B16.5, RF		ASME B16.5, RF		ASME B16.5, RF		ASME B16.5, RF	
8. Pressure Class	600		600		600		600	
9. Temperature	0°C to 150°C		0°C to 210°C		0°C to 210°C		0°C to 400°C	
10. Material Class	Carbon Steel		Carbon Steel		Carbon Steel		Carbon Steel	
11. Body Material	ASTM A105 or ASTM A216 Gr WCB + Inconel 625 weld overlay (acc. item A.7.1.7.3)		ASTM A105 or ASTM A216 Gr WCB + Inconel 625 weld overlay (acc. item A.7.1.7.3)		ASTM A105 or ASTM A216 Gr WCB + Inconel 625 weld overlay (acc. item A.7.1.7.3)		ASTM A105 or ASTM A216 Gr WCB + Inconel 625 weld overlay (acc. item A.7.1.7.3)	
12. Obturator Material	ASTM A105 + Inconel 625 weld overlay (acc. item A.7.1.7.3)		ASTM A105 + Inconel 625 weld overlay (acc. item A.7.1.7.3) + Tungsten carbide coating		ASTM A105 + Inconel 625 weld overlay (acc. item A.7.1.7.3) + Tungsten carbide coating		ASTM A105 + Inconel 625 weld overlay (acc. item A.7.1.7.3) + Chrome-Nickel Spray and Fuse (acc. Item A.8.2.2.4)	
13. Seat Material	ASTM A105 + Inconel 625 weld overlay (acc. item A.7.1.7.3)		ASTM A105 + Inconel 625 weld overlay (acc. item A.7.1.7.3) + Tungsten carbide coating		ASTM A105 + Inconel 625 weld overlay (acc. item A.7.1.7.3) + Tungsten carbide coating		ASTM A105 + Inconel 625 weld overlay (acc. item A.7.1.7.3) + Chrome-Nickel Spray and Fuse (acc. Item A.8.2.2.4)	
14. Seat Insert	PEEK		N/A		N/A		N/A	
15. Spring (Seat) Material	UNS N07750		UNS N07750		UNS N07750		UNS N07750	
16. Stem Material	ASTM B637 (UNS N07718)		ASTM B637 (UNS N07718)		ASTM B637 (UNS N07718)		ASTM B637 (UNS N07718)	
17. Seat-Stem Seal	Group D (acc. item A.7.1.5.6)		Group C (acc. item A.7.1.5.6)		Group D (acc. item A.7.1.5.6)		Group F (acc. item A.7.1.5.6)	
18. Operator Type	2" - 3"	Lever	2" - 3"	Lever	2" - 3"	Lever	2" - 3"	Lever
	4"	Gearbox	4"	Gearbox	4"	Gearbox	4"	Gearbox
19. Additional Requirement	N/A		N/A		N/A		N/A	
20. Seat Type	Side A: SPE / Side B: SPE; DBB		Side A: SPE / Side B: SPE		Side A: SPE / Side B: SPE		Side A: SPE / Side B: SPE	
21. Bore Type	Full Bore		Full Bore		Full Bore		Full Bore	
22. Body Construction	split body, bolted		split body, bolted		split body, bolted		split body, bolted	
23. Cladding or Coating	Full clad - Inconel 625 weld overlay on all wetted parts		Full clad - Inconel 625 weld overlay on all wetted parts		Full clad - Inconel 625 weld overlay on all wetted parts		Full clad - Inconel 625 weld overlay on all wetted parts	
24. Valve Testing	FAT according A.9.3		FAT according A.9.3		FAT according A.9.3		FAT according A.9.3	
25. Notes	N/A		N/A		N/A		N/A	

Valve Code	VES-600-1-D214		VES-600-1-D224		VES-600-1-D234		VES-600-1-S214	
Specs	E16		E16		E16		E3	
1. Valve Type	Ball		Ball		Ball		Ball	
2. Sealing Type	Soft		Soft		Soft		Soft	
3. Valve Specification Level (VSL)	VSL-1		VSL-1		VSL-1		VSL-1	
4. Ball Mouting	Trunnion		Trunnion		Trunnion		Trunnion	
5. Standard	API 6D / IOGP S-562		API 6D / IOGP S-562		API 6D / IOGP S-562		API 6D / IOGP S-562	
6. Size Range (NPS)	2" - 16"		2" - 16"		2" - 16"		2" - 24"	
7. End Connection	ASME B16.5, RF		ASME B16.5, RF		ASME B16.5, RF		ASME B16.5, RF	
8. Pressure Class	600		600		600		600	
9. Temperature	-30°C to 150°C		0°C to 150°C		-46°C to 150°C		-30°C to 150°C	
10. Material Class	Duplex Steel		Duplex Steel		Duplex Steel		Stainless Steel	
11. Body Material	ASTM A182 Gr F51 or ASTM A995 Gr 4a		ASTM A182 Gr F51 or ASTM A995 Gr 4a		ASTM A182 Gr F51 or ASTM A995 Gr 4a		ASTM A182 Gr F316 or ASTM A351 Gr CF8M	
12. Obturator Material	Duplex (UNS S31803)		Duplex (UNS S31803)		Duplex (UNS S31803)		AISI 316	
13. Seat Material	Duplex (UNS S31803)		Duplex (UNS S31803)		Duplex (UNS S31803)		AISI 316	
14. Seat Insert	PEEK		PEEK		PEEK		PEEK	
15. Spring (Seat) Material	UNS N07750		UNS N07750		UNS N07750		UNS N07750	
16. Stem Material	ASTM A276 (UNS S31803)		ASTM A276 (UNS S31803)		ASTM A276 (UNS S31803)		ASTM A276 (UNS S31600)	
17. Seat-Stem Seal	Group B (acc. item A.7.1.5.6)		Group C (acc. item A.7.1.5.6)		Group E (acc. item A.7.1.5.6)		Group B (acc. item A.7.1.5.6)	
18. Operator Type	2" - 3"	Lever	2" - 3"	Lever	2" - 3"	Lever	2" - 3"	Lever
	4" - 16"	Gearbox		4" - 16"		Gearbox		4" - 16"
19. Additional Requirement	N/A		N/A		N/A		N/A	
20. Seat Type	Side A: SPE / Side B: SPE; DBB		Side A: SPE / Side B: SPE; DBB		Side A: SPE / Side B: SPE; DBB		Side A: SPE / Side B: SPE; DBB	
21. Bore Type	Full Bore		Full Bore		Full Bore		Full Bore	
22. Body Construction	split body, bolted		split body, bolted		split body, bolted		split body, bolted	
23. Cladding or Coating	N/A		N/A		N/A		N/A	
24. Valve Testing	FAT according A.9.3		FAT according A.9.3		FAT according A.9.3		FAT according A.9.3	
25. Notes	N/A		N/A		N/A		N/A	

Valve Code	VES-600-1-S224		VES-600-1-S234		VES-600-1-S250		VES-600-1-S260	
Specs	E3		E3		E3		E3	
1. Valve Type	Ball		Ball		Ball		Ball	
2. Sealing Type	Soft		Soft		Metal to Metal		Metal to Metal	
3. Valve Specification Level (VSL)	VSL-1		VSL-1		VSL-1		VSL-1	
4. Ball Mouting	Trunnion		Trunnion		Trunnion		Trunnion	
5. Standard	API 6D / IOGP S-562		API 6D / IOGP S-562		API 6D / IOGP S-562		API 6D	
6. Size Range (NPS)	2" - 24"		2" - 24"		2" - 24"		2" - 24"	
7. End Connection	ASME B16.5, RF		ASME B16.5, RF		ASME B16.5, RF		ASME B16.5, RF	
8. Pressure Class	600		600		600		600	
9. Temperature	0°C to 150°C		-46°C to 150°C		-30°C to 150°C		0°C to 210°C	
10. Material Class	Stainless Steel		Stainless Steel		Stainless Steel		Stainless Steel	
11. Body Material	ASTM A182 Gr F316 or ASTM A351 Gr CF8M		ASTM A182 Gr F316 or ASTM A351 Gr CF8M		ASTM A182 Gr F316 or ASTM A351 Gr CF8M		ASTM A182 Gr F316 or ASTM A351 Gr CF8M	
12. Obturator Material	AISI 316		AISI 316		AISI 316 + Tungsten carbide coating		AISI 316 + Tungsten carbide coating	
13. Seat Material	AISI 316		AISI 316		AISI 316 + Tungsten carbide coating		AISI 316 + Tungsten carbide coating	
14. Seat Insert	PEEK		PEEK		N/A		N/A	
15. Spring (Seat) Material	UNS N07750		UNS N07750		UNS N07750		UNS N07750	
16. Stem Material	ASTM A276 (UNS S31600)		ASTM A276 (UNS S31600)		ASTM A276 (UNS S31600)		ASTM A276 (UNS S31600)	
17. Seat-Stem Seal	Group C (acc. item A.7.1.5.6)		Group E (acc. item A.7.1.5.6)		Group B (acc. item A.7.1.5.6)		Group C (acc. item A.7.1.5.6)	
18. Operator Type	2" - 3"	Lever	2" - 3"	Lever	2" - 3"	Lever	2" - 3"	Lever
	4" - 24"	Gearbox		4" - 24"		Gearbox		4" - 24"
19. Additional Requirement	N/A		N/A		N/A		N/A	
20. Seat Type	Side A: SPE / Side B: SPE; DBB		Side A: SPE / Side B: SPE; DBB		Side A: SPE / Side B: SPE		Side A: SPE / Side B: SPE	
21. Bore Type	Full Bore		Full Bore		Full Bore		Full Bore	
22. Body Construction	split body, bolted		split body, bolted		split body, bolted		split body, bolted	
23. Cladding or Coating	N/A		N/A		N/A		N/A	
24. Valve Testing	FAT according A.9.3		FAT according A.9.3		FAT according A.9.3		FAT according A.9.3	
25. Notes	N/A		N/A		N/A		N/A	

Valve Code	VES-600-1-S270		VES-600-2-A534		VES-600-2-A538		VES-600-2-A570	
Specs	E3		E32		E32		E32	
1. Valve Type	Ball		Ball		Ball		Ball	
2. Sealing Type	Metal to Metal		Soft		Soft		Metal to Metal	
3. Valve Specification Level (VSL)	VSL-1		VSL-2		VSL-2		VSL-2	
4. Ball Mouting	Trunnion		Trunnion		Trunnion		Trunnion	
5. Standard	API 6D		API 6D / IOGP S-562		API 6D / IOGP S-562		API 6D	
6. Size Range (NPS)	2" - 24"		2" - 16"		2" - 16"		2" - 16"	
7. End Connection	ASME B16.5, RF		ASME B16.5, RF		ASME B16.5, RF		ASME B16.5, RF	
8. Pressure Class	600		600		600		600	
9. Temperature	-100°C to 200°C		-46°C to 150°C		-46°C to 150°C		-100°C to 200°C	
10. Material Class	Stainless Steel		Alloy Steel		Alloy Steel		Alloy Steel	
11. Body Material	ASTM A182 Gr F316 or ASTM A351 Gr CF8M		ASTM A350 Gr LF3 or ASTM A352 Gr LC3 + Inconel 625 weld overlay (acc. item A.7.1.7.3)		ASTM A350 Gr LF3 or ASTM A352 Gr LC3 + Inconel 625 weld overlay (acc. item A.7.1.7.3)		ASTM A350 Gr LF3 or ASTM A352 Gr LC3 + Inconel 625 weld overlay (acc. item A.7.1.7.3)	
12. Obturator Material	AISI 316 + Tungsten carbide coating		ASTM A350 Gr LF3 + Inconel 625 weld overlay (acc. item A.7.1.7.3)		ASTM A350 Gr LF3 + Inconel 625 weld overlay (acc. item A.7.1.7.3)		ASTM A350 Gr LF3 + Inconel 625 weld overlay (acc. item A.7.1.7.3) + Tungsten carbide coating	
13. Seat Material	AISI 316 + Tungsten carbide coating		ASTM A350 Gr LF3 + Inconel 625 weld overlay (acc. item A.7.1.7.3)		ASTM A350 Gr LF3 + Inconel 625 weld overlay (acc. item A.7.1.7.3)		ASTM A350 Gr LF3 + Inconel 625 weld overlay (acc. item A.7.1.7.3) + Tungsten carbide coating	
14. Seat Insert	N/A		PEEK		PEEK		N/A	
15. Spring (Seat) Material	UNS N07750		UNS N07750		UNS N07750		UNS N07750	
16. Stem Material	ASTM A276 (UNS S31600)		ASTM B637 (UNS N07718)		ASTM B637 (UNS N07718)		ASTM B637 (UNS N07718)	
17. Seat-Stem Seal	Group E (acc. item A.7.1.5.6)		Group E (acc. item A.7.1.5.6)		Group E (acc. item A.7.1.5.6)		Group E (acc. item A.7.1.5.6)	
18. Operator Type	2" - 3"	Lever	2" - 3"	Lever	2" - 3"	Lever	2" - 3"	Lever
	4" - 24"	Gearbox	4" - 16"	Gearbox	4" - 16"	Gearbox	4" - 16"	Gearbox
19. Additional Requirement	N/A		N/A		N/A		N/A	
20. Seat Type	Side A: SPE / Side B: SPE		Side A: SPE / Side B: SPE; DBB		Side A: SPE / Side B: DPE; DIB-2 & DBB		Side A: SPE / Side B: SPE	
21. Bore Type	Full Bore		Full Bore		Full Bore		Full Bore	
22. Body Construction	split body, bolted		split body, bolted		split body, bolted		split body, bolted	
23. Cladding or Coating	N/A		Full clad - Inconel 625 weld overlay on all wetted parts		Full clad - Inconel 625 weld overlay on all wetted parts		Full clad - Inconel 625 weld overlay on all wetted parts	
24. Valve Testing	FAT according A.9.3		FAT according A.9.3		FAT according A.9.3		FAT according A.9.3	
25. Notes	N/A		N/A		N/A		N/A	

Valve Code	VES-600-2-A572		VES-600-2-A580		VES-600-2-A582		VES-600-2-C114	
Specs	E32		E32		E32		E9 E10	
1. Valve Type	Ball		Ball		Ball		Ball	
2. Sealing Type	Metal to Metal		Metal to Metal		Metal to Metal		Soft	
3. Valve Specification Level (VSL)	VSL-2		VSL-2		VSL-2		VSL-2	
4. Ball Mouting	Trunnion		Trunnion		Trunnion		Trunnion	
5. Standard	API 6D		API 6D		API 6D		API 6D / IOGP S-562	
6. Size Range (NPS)	2" - 16"		2" - 16"		2" - 16"		2" - 24"	
7. End Connection	ASME B16.5, RF		ASME B16.5, RF		ASME B16.5, RF		ASME B16.5, RF	
8. Pressure Class	600		600		600		600	
9. Temperature	-100°C to 200°C		-100°C to 340°C		-100°C to 400°C		-29°C to 150°C	
10. Material Class	Alloy Steel		Alloy Steel		Alloy Steel		Carbon Steel	
11. Body Material	ASTM A350 Gr LF3 or ASTM A352 Gr LC3 + Inconel 625 weld overlay (acc. item A.7.1.7.3)		ASTM A350 Gr LF3 or ASTM A352 Gr LC3 + Inconel 625 weld overlay (acc. item A.7.1.7.3)		ASTM A350 Gr LF3 or ASTM A352 Gr LC3 + Inconel 625 weld overlay (acc. item A.7.1.7.3)		ASTM A105 or ASTM A216 Gr WCB + SS316 weld overlay (acc. item A.7.1.7.3)	
12. Obturator Material	ASTM A350 Gr LF3 + Inconel 625 weld overlay (acc. item A.7.1.7.3) + Tungsten carbide coating		ASTM A350 Gr LF3 + Inconel 625 weld overlay (acc. item A.7.1.7.3) + Chrome-Nickel Spray and Fuse (acc. Item A.8.2.2.4)		ASTM A350 Gr LF3 + Inconel 625 weld overlay (acc. item A.7.1.7.3) + Chrome-Nickel Spray and Fuse (acc. Item A.8.2.2.4)		AISI 410	
13. Seat Material	ASTM A350 Gr LF3 + Inconel 625 weld overlay (acc. item A.7.1.7.3) + Tungsten carbide coating		ASTM A350 Gr LF3 + Inconel 625 weld overlay (acc. item A.7.1.7.3) + Chrome-Nickel Spray and Fuse (acc. Item A.8.2.2.4)		ASTM A350 Gr LF3 + Inconel 625 weld overlay (acc. item A.7.1.7.3) + Chrome-Nickel Spray and Fuse (acc. Item A.8.2.2.4)		AISI 410	
14. Seat Insert	N/A		N/A		N/A		PEEK	
15. Spring (Seat) Material	UNS N07750		UNS N07750		UNS N07750		UNS N07750	
16. Stem Material	ASTM B637 (UNS N07718)		ASTM B637 (UNS N07718)		ASTM B637 (UNS N07718)		ASTM A276 (UNS S41000)	
17. Seat-Stem Seal	Group E (acc. item A.7.1.5.6)		Group F (acc. item A.7.1.5.6)		Group F (acc. item A.7.1.5.6)		Group B (acc. item A.7.1.5.6)	
18. Operator Type	2" - 3"	Lever	2" - 3"	Lever	2" - 3"	Lever	2" - 3"	Lever
	4" - 16"	Gearbox	4" - 16"	Gearbox	4" - 16"	Gearbox	4" - 24"	Gearbox
19. Additional Requirement	N/A		N/A		N/A		N/A	
20. Seat Type	Side A: SPE / Side B: DPE; DIB-2 & DBB		Side A: SPE / Side B: SPE		Side A: SPE / Side B: DPE; DIB-2 & DBB		Side A: SPE / Side B: SPE; DBB	
21. Bore Type	Full Bore		Full Bore		Full Bore		Full Bore	
22. Body Construction	split body, bolted		split body, bolted		split body, bolted		split body, bolted	
23. Cladding or Coating	Full clad - Inconel 625 weld overlay on all wetted parts		Full clad - Inconel 625 weld overlay on all wetted parts		Full clad - Inconel 625 weld overlay on all wetted parts		Partial clad - SS316 weld overlay on all body sealing areas	
24. Valve Testing	FAT according A.9.3		FAT according A.9.3		FAT according A.9.3		FAT according A.9.3	
25. Notes	N/A		N/A		N/A		N/A	

Valve Code	VES-600-2-C118		VES-600-2-C124		VES-600-2-C128		VES-600-2-C134	
Specs	E9 E10		E10		E9 E10		E9 E10	
1. Valve Type	Ball		Ball		Ball		Ball	
2. Sealing Type	Soft		Soft		Soft		Soft	
3. Valve Specification Level (VSL)	VSL-2		VSL-2		VSL-2		VSL-2	
4. Ball Mouting	Trunnion		Trunnion		Trunnion		Trunnion	
5. Standard	API 6D / IOGP S-562		API 6D / IOGP S-562		API 6D / IOGP S-562		API 6D / IOGP S-562	
6. Size Range (NPS)	2" - 24"		2" - 24"		2" - 24"		2" - 24"	
7. End Connection	ASME B16.5, RF		ASME B16.5, RF		ASME B16.5, RF		ASME B16.5, RF	
8. Pressure Class	600		600		600		600	
9. Temperature	-29°C to 150°C		0°C to 150°C		0°C to 150°C		0°C to 150°C	
10. Material Class	Carbon Steel		Carbon Steel		Carbon Steel		Carbon Steel	
11. Body Material	ASTM A105 or ASTM A216 Gr WCB + SS316 weld overlay (acc. item A.7.1.7.3)		ASTM A105 or ASTM A216 Gr WCB + SS316 weld overlay (acc. item A.7.1.7.3)		ASTM A105 or ASTM A216 Gr WCB + SS316 weld overlay (acc. item A.7.1.7.3)		ASTM A105 or ASTM A216 Gr WCB + SS316 weld overlay (acc. item A.7.1.7.3)	
12. Obturator Material	AISI 410		AISI 410		AISI 410		AISI 410	
13. Seat Material	AISI 410		AISI 410		AISI 410		AISI 410	
14. Seat Insert	PEEK		PEEK		PEEK		PEEK	
15. Spring (Seat) Material	UNS N07750		UNS N07750		UNS N07750		UNS N07750	
16. Stem Material	ASTM A276 (UNS S41000)		ASTM A276 (UNS S41000)		ASTM A276 (UNS S41000)		ASTM A276 (UNS S41000)	
17. Seat-Stem Seal	Group B (acc. item A.7.1.5.6)		Group C (acc. item A.7.1.5.6)		Group C (acc. item A.7.1.5.6)		Group D (acc. item A.7.1.5.6)	
18. Operator Type	2" - 3"	Lever	2" - 3"	Lever	2" - 3"	Lever	2" - 3"	Lever
	4" - 24"	Gearbox	4" - 24"	Gearbox	4" - 24"	Gearbox	4" - 24"	Gearbox
19. Additional Requirement	N/A		N/A		N/A		N/A	
20. Seat Type	Side A: SPE / Side B: DPE; DIB-2 & DBB		Side A: SPE / Side B: SPE; DBB		Side A: SPE / Side B: DPE; DIB-2 & DBB		Side A: SPE / Side B: SPE; DBB	
21. Bore Type	Full Bore		Full Bore		Full Bore		Full Bore	
22. Body Construction	split body, bolted		split body, bolted		split body, bolted		split body, bolted	
23. Cladding or Coating	Partial clad - SS316 weld overlay on all body sealing areas		Partial clad - SS316 weld overlay on all body sealing areas		Partial clad - SS316 weld overlay on all body sealing areas		Partial clad - SS316 weld overlay on all body sealing areas	
24. Valve Testing	FAT according A.9.3		FAT according A.9.3		FAT according A.9.3		FAT according A.9.3	
25. Notes	N/A		N/A		N/A		N/A	

Valve Code	VES-600-2-C138		VES-600-2-C150		VES-600-2-C152		VES-600-2-C160	
Specs	E9 E10		E9 E10		E9 E10		E10	
1. Valve Type	Ball		Ball		Ball		Ball	
2. Sealing Type	Soft		Metal to Metal		Metal to Metal		Metal to Metal	
3. Valve Specification Level (VSL)	VSL-2		VSL-2		VSL-2		VSL-2	
4. Ball Mouting	Trunnion		Trunnion		Trunnion		Trunnion	
5. Standard	API 6D / IOGP S-562		API 6D / IOGP S-562		API 6D / IOGP S-562		API 6D	
6. Size Range (NPS)	2" - 24"		2" - 24"		2" - 24"		2" - 24"	
7. End Connection	ASME B16.5, RF		ASME B16.5, RF		ASME B16.5, RF		ASME B16.5, RF	
8. Pressure Class	600		600		600		600	
9. Temperature	0°C to 150°C		0°C to 150°C		0°C to 150°C		0°C to 210°C	
10. Material Class	Carbon Steel		Carbon Steel		Carbon Steel		Carbon Steel	
11. Body Material	ASTM A105 or ASTM A216 Gr WCB + SS316 weld overlay (acc. item A.7.1.7.3)		ASTM A105 or ASTM A216 Gr WCB + SS316 weld overlay (acc. item A.7.1.7.3)		ASTM A105 or ASTM A216 Gr WCB + SS316 weld overlay (acc. item A.7.1.7.3)		ASTM A105 or ASTM A216 Gr WCB + SS316 weld overlay (acc. item A.7.1.7.3)	
12. Obturator Material	AISI 410		AISI 410 + Tungsten carbide coating		AISI 410 + Tungsten carbide coating		AISI 410 + Tungsten carbide coating	
13. Seat Material	AISI 410		AISI 410 + Tungsten carbide coating		AISI 410 + Tungsten carbide coating		AISI 410 + Tungsten carbide coating	
14. Seat Insert	PEEK		N/A		N/A		N/A	
15. Spring (Seat) Material	UNS N07750		UNS N07750		UNS N07750		UNS N07750	
16. Stem Material	ASTM A276 (UNS S41000)		ASTM A276 (UNS S41000)		ASTM A276 (UNS S41000)		ASTM A276 (UNS S41000)	
17. Seat-Stem Seal	Group D (acc. item A.7.1.5.6)		Group A (acc. item A.7.1.5.6)		Group B (acc. item A.7.1.5.6)		Group C (acc. item A.7.1.5.6)	
18. Operator Type	2" - 3"	Lever	2" - 3"	Lever	2" - 3"	Lever	2" - 3"	Lever
	4" - 24"	Gearbox	4" - 24"	Gearbox	4" - 24"	Gearbox	4" - 24"	Gearbox
19. Additional Requirement	N/A		N/A		N/A		N/A	
20. Seat Type	Side A: SPE / Side B: DPE; DIB-2 & DBB		Side A: SPE / Side B: SPE		Side A: SPE / Side B: DPE; DIB-2 & DBB		Side A: SPE / Side B: SPE	
21. Bore Type	Full Bore		Full Bore		Full Bore		Full Bore	
22. Body Construction	split body, bolted		split body, bolted		split body, bolted		split body, bolted	
23. Cladding or Coating	Partial clad - SS316 weld overlay on all body sealing areas		Partial clad - SS316 weld overlay on all body sealing areas		Partial clad - SS316 weld overlay on all body sealing areas		Partial clad - SS316 weld overlay on all body sealing areas	
24. Valve Testing	FAT according A.9.3		FAT according A.9.3		FAT according A.9.3		FAT according A.9.3	
25. Notes	N/A		N/A		N/A		N/A	

Valve Code	VES-600-2-C162		VES-600-2-C170		VES-600-2-C172		VES-600-2-C214	
Specs	E9 E10		E9 E10		E9 E10		E6 E19	
1. Valve Type	Ball		Ball		Ball		Ball	
2. Sealing Type	Metal to Metal		Metal to Metal		Metal to Metal		Soft	
3. Valve Specification Level (VSL)	VSL-2		VSL-2		VSL-2		VSL-2	
4. Ball Mouting	Trunnion		Trunnion		Trunnion		Trunnion	
5. Standard	API 6D		API 6D		API 6D		API 6D / IOGP S-562	
6. Size Range (NPS)	2" - 24"		2" - 24"		2" - 24"		2" - 24"	
7. End Connection	ASME B16.5, RF		ASME B16.5, RF		ASME B16.5, RF		ASME B16.5, RF	
8. Pressure Class	600		600		600		600	
9. Temperature	0°C to 210°C		0°C to 210°C		0°C to 210°C		-30°C to 150°C	
10. Material Class	Carbon Steel		Carbon Steel		Carbon Steel		Carbon Steel	
11. Body Material	ASTM A105 or ASTM A216 Gr WCB + SS316 weld overlay (acc. item A.7.1.7.3)		ASTM A105 or ASTM A216 Gr WCB + SS316 weld overlay (acc. item A.7.1.7.3)		ASTM A105 or ASTM A216 Gr WCB + SS316 weld overlay (acc. item A.7.1.7.3)		ASTM A350 Gr LF2 CL1 or ASTM A352 Gr LCB + Inconel 625 weld overlay (acc. item A.7.1.7.3)	
12. Obturator Material	AISI 410 + Tungsten carbide coating		AISI 410 + Tungsten carbide coating		AISI 410 + Tungsten carbide coating		AISI 316	
13. Seat Material	AISI 410 + Tungsten carbide coating		AISI 410 + Tungsten carbide coating		AISI 410 + Tungsten carbide coating		AISI 316	
14. Seat Insert	N/A		N/A		N/A		PEEK	
15. Spring (Seat) Material	UNS N07750		UNS N07750		UNS N07750		UNS N07750	
16. Stem Material	ASTM A276 (UNS S41000)		ASTM A276 (UNS S41000)		ASTM A276 (UNS S41000)		ASTM A276 (UNS S31600)	
17. Seat-Stem Seal	Group C (acc. item A.7.1.5.6)		Group D (acc. item A.7.1.5.6)		Group D (acc. item A.7.1.5.6)		Group B (acc. item A.7.1.5.6)	
18. Operator Type	2" - 3"	Lever	2" - 3"	Lever	2" - 3"	Lever	2" - 3"	Lever
	4" - 24"	Gearbox	4" - 24"	Gearbox	4" - 24"	Gearbox	4" - 24"	Gearbox
19. Additional Requirement	N/A		N/A		N/A		N/A	
20. Seat Type	Side A: SPE / Side B: DPE; DIB-2 & DBB		Side A: SPE / Side B: SPE		Side A: SPE / Side B: DPE; DIB-2 & DBB		Side A: SPE / Side B: SPE; DBB	
21. Bore Type	Full Bore		Full Bore		Full Bore		Full Bore	
22. Body Construction	split body, bolted		split body, bolted		split body, bolted		split body, bolted	
23. Cladding or Coating	Partial clad - SS316 weld overlay on all body sealing areas		Partial clad - SS316 weld overlay on all body sealing areas		Partial clad - SS316 weld overlay on all body sealing areas		Partial clad - Inconel 625 weld overlay on all body sealing areas	
24. Valve Testing	FAT according A.9.3		FAT according A.9.3		FAT according A.9.3		FAT according A.9.3	
25. Notes	N/A		N/A		N/A		N/A	

Valve Code	VES-600-2-C218		VES-600-2-C234		VES-600-2-C238		VES-600-2-C252	
Specs	E6 E19		E6 E19		E6 E19		E6 E19	
1. Valve Type	Ball		Ball		Ball		Ball	
2. Sealing Type	Soft		Soft		Soft		Metal to Metal	
3. Valve Specification Level (VSL)	VSL-2		VSL-2		VSL-2		VSL-2	
4. Ball Mouting	Trunnion		Trunnion		Trunnion		Trunnion	
5. Standard	API 6D / IOGP S-562		API 6D / IOGP S-562		API 6D / IOGP S-562		API 6D / IOGP S-562	
6. Size Range (NPS)	2" - 24"		2" - 24"		2" - 24"		2" - 24"	
7. End Connection	ASME B16.5, RF		ASME B16.5, RF		ASME B16.5, RF		ASME B16.5, RF	
8. Pressure Class	600		600		600		600	
9. Temperature	-30°C to 150°C		-46°C to 150°C		-46°C to 150°C		-30°C to 150°C	
10. Material Class	Carbon Steel		Carbon Steel		Carbon Steel		Carbon Steel	
11. Body Material	ASTM A350 Gr LF2 CL1 or ASTM A352 Gr LCB + Inconel 625 weld overlay (acc. item A.7.1.7.3)		ASTM A350 Gr LF2 CL1 or ASTM A352 Gr LCB + Inconel 625 weld overlay (acc. item A.7.1.7.3)		ASTM A350 Gr LF2 CL1 or ASTM A352 Gr LCB + Inconel 625 weld overlay (acc. item A.7.1.7.3)		ASTM A350 Gr LF2 CL1 or ASTM A352 Gr LCB + Inconel 625 weld overlay (acc. item A.7.1.7.3)	
12. Obturator Material	AISI 316		AISI 316		AISI 316		AISI 316 + Tungsten carbide coating	
13. Seat Material	AISI 316		AISI 316		AISI 316		AISI 316 + Tungsten carbide coating	
14. Seat Insert	PEEK		PEEK		PEEK		N/A	
15. Spring (Seat) Material	UNS N07750		UNS N07750		UNS N07750		UNS N07750	
16. Stem Material	ASTM A276 (UNS S31600)		ASTM A276 (UNS S31600)		ASTM A276 (UNS S31600)		ASTM A276 (UNS S31600)	
17. Seat-Stem Seal	Group B (acc. item A.7.1.5.6)		Group E (acc. item A.7.1.5.6)		Group E (acc. item A.7.1.5.6)		Group B (acc. item A.7.1.5.6)	
18. Operator Type	2" - 3"	Lever	2" - 3"	Lever	2" - 3"	Lever	2" - 3"	Lever
	4" - 24"	Gearbox	4" - 24"	Gearbox	4" - 24"	Gearbox	4" - 24"	Gearbox
19. Additional Requirement	N/A		N/A		N/A		N/A	
20. Seat Type	Side A: SPE / Side B: DPE; DIB-2 & DBB		Side A: SPE / Side B: SPE; DBB		Side A: SPE / Side B: DPE; DIB-2 & DBB		Side A: SPE / Side B: DPE; DIB-2 & DBB	
21. Bore Type	Full Bore		Full Bore		Full Bore		Full Bore	
22. Body Construction	split body, bolted		split body, bolted		split body, bolted		split body, bolted	
23. Cladding or Coating	Partial clad - Inconel 625 weld overlay on all body sealing areas		Partial clad - Inconel 625 weld overlay on all body sealing areas		Partial clad - Inconel 625 weld overlay on all body sealing areas		Partial clad - Inconel 625 weld overlay on all body sealing areas	
24. Valve Testing	FAT according A.9.3		FAT according A.9.3		FAT according A.9.3		FAT according A.9.3	
25. Notes	N/A		N/A		N/A		N/A	

Valve Code	VES-600-2-C270		VES-600-2-C510		VES-600-2-C524		VES-600-2-C528	
Specs	E6		E30		E30		E30	
1. Valve Type	Ball		Ball		Ball		Ball	
2. Sealing Type	Metal to Metal		Soft		Soft		Soft	
3. Valve Specification Level (VSL)	VSL-2		VSL-2		VSL-2		VSL-2	
4. Ball Mouting	Trunnion		Trunnion		Trunnion		Trunnion	
5. Standard	API 6D		API 6D / IOGP S-562		API 6D / IOGP S-562		API 6D / IOGP S-562	
6. Size Range (NPS)	2" - 24"		2" - 20"		2" - 20"		2" - 20"	
7. End Connection	ASME B16.5, RF		ASME B16.5, RF		ASME B16.5, RF		ASME B16.5, RF	
8. Pressure Class	600		600		600		600	
9. Temperature	-46°C to 200°C		-29°C to 150°C		0°C to 150°C		0°C to 150°C	
10. Material Class	Carbon Steel		Carbon Steel		Carbon Steel		Carbon Steel	
11. Body Material	ASTM A350 Gr LF2 CL1 or ASTM A352 Gr LCB + Inconel 625 weld overlay (acc. item A.7.1.7.3)		ASTM A105 or ASTM A216 Gr WCB + Inconel 625 weld overlay (acc. item A.7.1.7.3)		ASTM A105 or ASTM A216 Gr WCB + Inconel 625 weld overlay (acc. item A.7.1.7.3)		ASTM A105 or ASTM A216 Gr WCB + Inconel 625 weld overlay (acc. item A.7.1.7.3)	
12. Obturator Material	AISI 316 + Tungsten carbide coating		ASTM A105 + Inconel 625 weld overlay (acc. item A.7.1.7.3)		ASTM A105 + Inconel 625 weld overlay (acc. item A.7.1.7.3)		ASTM A105 + Inconel 625 weld overlay (acc. item A.7.1.7.3)	
13. Seat Material	AISI 316 + Tungsten carbide coating		ASTM A105 + Inconel 625 weld overlay (acc. item A.7.1.7.3)		ASTM A105 + Inconel 625 weld overlay (acc. item A.7.1.7.3)		ASTM A105 + Inconel 625 weld overlay (acc. item A.7.1.7.3)	
14. Seat Insert	N/A		PTFE reinforced with 25% Carbon		PEEK		PEEK	
15. Spring (Seat) Material	UNS N07750		UNS N07750		UNS N07750		UNS N07750	
16. Stem Material	ASTM A276 (UNS S31600)		ASTM B637 (UNS N07718)		ASTM B637 (UNS N07718)		ASTM B637 (UNS N07718)	
17. Seat-Stem Seal	Group E (acc. item A.7.1.5.6)		Group B (acc. item A.7.1.5.6)		Group C (acc. item A.7.1.5.6)		Group C (acc. item A.7.1.5.6)	
18. Operator Type	2" - 3"	Lever	2" - 3"	Lever	2" - 3"	Lever	2" - 3"	Lever
	4" - 24"	Gearbox	4" - 20"	Gearbox	4" - 20"	Gearbox	4" - 20"	Gearbox
19. Additional Requirement	N/A		N/A		N/A		N/A	
20. Seat Type	Side A: SPE / Side B: SPE		Side A: SPE / Side B: SPE		Side A: SPE / Side B: SPE; DBB		Side A: SPE / Side B: DPE; DIB-2 & DBB	
21. Bore Type	Full Bore		Full Bore		Full Bore		Full Bore	
22. Body Construction	split body, bolted		split body, bolted		split body, bolted		split body, bolted	
23. Cladding or Coating	Partial clad - Inconel 625 weld overlay on all body sealing areas		Full clad - Inconel 625 weld overlay on all wetted parts		Full clad - Inconel 625 weld overlay on all wetted parts		Full clad - Inconel 625 weld overlay on all wetted parts	
24. Valve Testing	FAT according A.9.3		FAT according A.9.3		FAT according A.9.3		FAT according A.9.3	
25. Notes	N/A		N/A		N/A		N/A	

Valve Code	VES-600-2-C534		VES-600-2-C538		VES-600-2-C560		VES-600-2-C562	
Specs	E30		E30		E30		E30	
1. Valve Type	Ball		Ball		Ball		Ball	
2. Sealing Type	Soft		Soft		Metal to Metal		Metal to Metal	
3. Valve Specification Level (VSL)	VSL-2		VSL-2		VSL-2		VSL-2	
4. Ball Mouting	Trunnion		Trunnion		Trunnion		Trunnion	
5. Standard	API 6D / IOGP S-562		API 6D / IOGP S-562		API 6D		API 6D	
6. Size Range (NPS)	2" - 20"		2" - 20"		2" - 20"		2" - 20"	
7. End Connection	ASME B16.5, RF		ASME B16.5, RF		ASME B16.5, RF		ASME B16.5, RF	
8. Pressure Class	600		600		600		600	
9. Temperature	0°C to 150°C		0°C to 150°C		0°C to 210°C		0°C to 210°C	
10. Material Class	Carbon Steel		Carbon Steel		Carbon Steel		Carbon Steel	
11. Body Material	ASTM A105 or ASTM A216 Gr WCB + Inconel 625 weld overlay (acc. item A.7.1.7.3)		ASTM A105 or ASTM A216 Gr WCB + Inconel 625 weld overlay (acc. item A.7.1.7.3)		ASTM A105 or ASTM A216 Gr WCB + Inconel 625 weld overlay (acc. item A.7.1.7.3)		ASTM A105 or ASTM A216 Gr WCB + Inconel 625 weld overlay (acc. item A.7.1.7.3)	
12. Obturator Material	ASTM A105 + Inconel 625 weld overlay (acc. item A.7.1.7.3)		ASTM A105 + Inconel 625 weld overlay (acc. item A.7.1.7.3)		ASTM A105 + Inconel 625 weld overlay (acc. item A.7.1.7.3) + Tungsten carbide coating		ASTM A105 + Inconel 625 weld overlay (acc. item A.7.1.7.3) + Tungsten carbide coating	
13. Seat Material	ASTM A105 + Inconel 625 weld overlay (acc. item A.7.1.7.3)		ASTM A105 + Inconel 625 weld overlay (acc. item A.7.1.7.3)		ASTM A105 + Inconel 625 weld overlay (acc. item A.7.1.7.3) + Tungsten carbide coating		ASTM A105 + Inconel 625 weld overlay (acc. item A.7.1.7.3) + Tungsten carbide coating	
14. Seat Insert	PEEK		PEEK		N/A		N/A	
15. Spring (Seat) Material	UNS N07750		UNS N07750		UNS N07750		UNS N07750	
16. Stem Material	ASTM B637 (UNS N07718)		ASTM B637 (UNS N07718)		ASTM B637 (UNS N07718)		ASTM B637 (UNS N07718)	
17. Seat-Stem Seal	Group D (acc. item A.7.1.5.6)		Group D (acc. item A.7.1.5.6)		Group C (acc. item A.7.1.5.6)		Group C (acc. item A.7.1.5.6)	
18. Operator Type	2" - 3"	Lever	2" - 3"	Lever	2" - 3"	Lever	2" - 3"	Lever
	4" - 20"	Gearbox	4" - 20"	Gearbox	4" - 20"	Gearbox	4" - 20"	Gearbox
19. Additional Requirement	N/A		N/A		N/A		N/A	
20. Seat Type	Side A: SPE / Side B: SPE; DBB		Side A: SPE / Side B: DPE; DIB-2 & DBB		Side A: SPE / Side B: SPE		Side A: SPE / Side B: DPE; DIB-2 & DBB	
21. Bore Type	Full Bore		Full Bore		Full Bore		Full Bore	
22. Body Construction	split body, bolted		split body, bolted		split body, bolted		split body, bolted	
23. Cladding or Coating	Full clad - Inconel 625 weld overlay on all wetted parts		Full clad - Inconel 625 weld overlay on all wetted parts		Full clad - Inconel 625 weld overlay on all wetted parts		Full clad - Inconel 625 weld overlay on all wetted parts	
24. Valve Testing	FAT according A.9.3		FAT according A.9.3		FAT according A.9.3		FAT according A.9.3	
25. Notes	N/A		N/A		N/A		N/A	

Valve Code	VES-600-2-C570		VES-600-2-C572		VES-600-2-C580		VES-600-2-C582	
Specs	E30		E30		E30		E30	
1. Valve Type	Ball		Ball		Ball		Ball	
2. Sealing Type	Metal to Metal		Metal to Metal		Metal to Metal		Metal to Metal	
3. Valve Specification Level (VSL)	VSL-2		VSL-2		VSL-2		VSL-2	
4. Ball Mouting	Trunnion		Trunnion		Trunnion		Trunnion	
5. Standard	API 6D		API 6D		API 6D		API 6D	
6. Size Range (NPS)	2" - 20"		2" - 20"		2" - 20"		2" - 20"	
7. End Connection	ASME B16.5, RF		ASME B16.5, RF		ASME B16.5, RF		ASME B16.5, RF	
8. Pressure Class	600		600		600		600	
9. Temperature	0°C to 210°C		0°C to 210°C		0°C to 400°C		0°C to 400°C	
10. Material Class	Carbon Steel		Carbon Steel		Carbon Steel		Carbon Steel	
11. Body Material	ASTM A105 or ASTM A216 Gr WCB + Inconel 625 weld overlay (acc. item A.7.1.7.3)		ASTM A105 or ASTM A216 Gr WCB + Inconel 625 weld overlay (acc. item A.7.1.7.3)		ASTM A105 or ASTM A216 Gr WCB + Inconel 625 weld overlay (acc. item A.7.1.7.3)		ASTM A105 or ASTM A216 Gr WCB + Inconel 625 weld overlay (acc. item A.7.1.7.3)	
12. Obturator Material	ASTM A105 + Inconel 625 weld overlay (acc. item A.7.1.7.3) + Tungsten carbide coating		ASTM A105 + Inconel 625 weld overlay (acc. item A.7.1.7.3) + Tungsten carbide coating		ASTM A105 + Inconel 625 weld overlay (acc. item A.7.1.7.3) + Chrome-Nickel Spray and Fuse (acc. Item A.8.2.2.4)		ASTM A105 + Inconel 625 weld overlay (acc. item A.7.1.7.3) + Chrome-Nickel Spray and Fuse (acc. Item A.8.2.2.4)	
13. Seat Material	ASTM A105 + Inconel 625 weld overlay (acc. item A.7.1.7.3) + Tungsten carbide coating		ASTM A105 + Inconel 625 weld overlay (acc. item A.7.1.7.3) + Tungsten carbide coating		ASTM A105 + Inconel 625 weld overlay (acc. item A.7.1.7.3) + Chrome-Nickel Spray and Fuse (acc. Item A.8.2.2.4)		ASTM A105 + Inconel 625 weld overlay (acc. item A.7.1.7.3) + Chrome-Nickel Spray and Fuse (acc. Item A.8.2.2.4)	
14. Seat Insert	N/A		N/A		N/A		N/A	
15. Spring (Seat) Material	UNS N07750		UNS N07750		UNS N07750		UNS N07750	
16. Stem Material	ASTM B637 (UNS N07718)		ASTM B637 (UNS N07718)		ASTM B637 (UNS N07718)		ASTM B637 (UNS N07718)	
17. Seat-Stem Seal	Group D (acc. item A.7.1.5.6)		Group D (acc. item A.7.1.5.6)		Group F (acc. item A.7.1.5.6)		Group F (acc. item A.7.1.5.6)	
18. Operator Type	2" - 3"	Lever	2" - 3"	Lever	2" - 3"	Lever	2" - 3"	Lever
	4" - 20"	Gearbox	4" - 20"	Gearbox	4" - 20"	Gearbox	4" - 20"	Gearbox
19. Additional Requirement	N/A		N/A		N/A		N/A	
20. Seat Type	Side A: SPE / Side B: SPE		Side A: SPE / Side B: DPE; DIB-2 & DBB		Side A: SPE / Side B: SPE		Side A: SPE / Side B: DPE; DIB-2 & DBB	
21. Bore Type	Full Bore		Full Bore		Full Bore		Full Bore	
22. Body Construction	split body, bolted		split body, bolted		split body, bolted		split body, bolted	
23. Cladding or Coating	Full clad - Inconel 625 weld overlay on all wetted parts		Full clad - Inconel 625 weld overlay on all wetted parts		Full clad - Inconel 625 weld overlay on all wetted parts		Full clad - Inconel 625 weld overlay on all wetted parts	
24. Valve Testing	FAT according A.9.3		FAT according A.9.3		FAT according A.9.3		FAT according A.9.3	
25. Notes	N/A		N/A		N/A		N/A	

Valve Code	VES-600-2-D214		VES-600-2-D218		VES-600-2-D224		VES-600-2-D228	
Specs	E16		E16		E16		E16	
1. Valve Type	Ball		Ball		Ball		Ball	
2. Sealing Type	Soft		Soft		Soft		Soft	
3. Valve Specification Level (VSL)	VSL-2		VSL-2		VSL-2		VSL-2	
4. Ball Mouting	Trunnion		Trunnion		Trunnion		Trunnion	
5. Standard	API 6D / IOGP S-562		API 6D / IOGP S-562		API 6D / IOGP S-562		API 6D / IOGP S-562	
6. Size Range (NPS)	2" - 16"		2" - 16"		2" - 16"		2" - 16"	
7. End Connection	ASME B16.5, RF		ASME B16.5, RF		ASME B16.5, RF		ASME B16.5, RF	
8. Pressure Class	600		600		600		600	
9. Temperature	-30°C to 150°C		-30°C to 150°C		0°C to 150°C		0°C to 150°C	
10. Material Class	Duplex Steel		Duplex Steel		Duplex Steel		Duplex Steel	
11. Body Material	ASTM A182 Gr F51 or ASTM A995 Gr 4a		ASTM A182 Gr F51 or ASTM A995 Gr 4a		ASTM A182 Gr F51 or ASTM A995 Gr 4a		ASTM A182 Gr F51 or ASTM A995 Gr 4a	
12. Obturator Material	Duplex (UNS S31803)		Duplex (UNS S31803)		Duplex (UNS S31803)		Duplex (UNS S31803)	
13. Seat Material	Duplex (UNS S31803)		Duplex (UNS S31803)		Duplex (UNS S31803)		Duplex (UNS S31803)	
14. Seat Insert	PEEK		PEEK		PEEK		PEEK	
15. Spring (Seat) Material	UNS N07750		UNS N07750		UNS N07750		UNS N07750	
16. Stem Material	ASTM A276 (UNS S31803)		ASTM A276 (UNS S31803)		ASTM A276 (UNS S31803)		ASTM A276 (UNS S31803)	
17. Seat-Stem Seal	Group B (acc. item A.7.1.5.6)		Group B (acc. item A.7.1.5.6)		Group C (acc. item A.7.1.5.6)		Group C (acc. item A.7.1.5.6)	
18. Operator Type	2" - 3"	Lever	2" - 3"	Lever	2" - 3"	Lever	2" - 3"	Lever
	4" - 16"	Gearbox						
19. Additional Requirement	N/A		N/A		N/A		N/A	
20. Seat Type	Side A: SPE / Side B: SPE; DBB		Side A: SPE / Side B: DPE; DIB-2 & DBB		Side A: SPE / Side B: SPE; DBB		Side A: SPE / Side B: DPE; DIB-2 & DBB	
21. Bore Type	Full Bore		Full Bore		Full Bore		Full Bore	
22. Body Construction	split body, bolted		split body, bolted		split body, bolted		split body, bolted	
23. Cladding or Coating	N/A		N/A		N/A		N/A	
24. Valve Testing	FAT according A.9.3		FAT according A.9.3		FAT according A.9.3		FAT according A.9.3	
25. Notes	N/A		N/A		N/A		N/A	

Valve Code	VES-600-2-D234		VES-600-2-D238		VES-600-2-S214		VES-600-2-S218	
Specs	E16		E16		E3		E3	
1. Valve Type	Ball		Ball		Ball		Ball	
2. Sealing Type	Soft		Soft		Soft		Soft	
3. Valve Specification Level (VSL)	VSL-2		VSL-2		VSL-2		VSL-2	
4. Ball Mouting	Trunnion		Trunnion		Trunnion		Trunnion	
5. Standard	API 6D / IOGP S-562		API 6D / IOGP S-562		API 6D / IOGP S-562		API 6D / IOGP S-562	
6. Size Range (NPS)	2" - 16"		2" - 16"		2" - 24"		2" - 24"	
7. End Connection	ASME B16.5, RF		ASME B16.5, RF		ASME B16.5, RF		ASME B16.5, RF	
8. Pressure Class	600		600		600		600	
9. Temperature	-46°C to 150°C		-46°C to 150°C		-30°C to 150°C		-30°C to 150°C	
10. Material Class	Duplex Steel		Duplex Steel		Stainless Steel		Stainless Steel	
11. Body Material	ASTM A182 Gr F51 or ASTM A995 Gr 4a		ASTM A182 Gr F51 or ASTM A995 Gr 4a		ASTM A182 Gr F316 or ASTM A351 Gr CF8M		ASTM A182 Gr F316 or ASTM A351 Gr CF8M	
12. Obturator Material	Duplex (UNS S31803)		Duplex (UNS S31803)		AISI 316		AISI 316	
13. Seat Material	Duplex (UNS S31803)		Duplex (UNS S31803)		AISI 316		AISI 316	
14. Seat Insert	PEEK		PEEK		PEEK		PEEK	
15. Spring (Seat) Material	UNS N07750		UNS N07750		UNS N07750		UNS N07750	
16. Stem Material	ASTM A276 (UNS S31803)		ASTM A276 (UNS S31803)		ASTM A276 (UNS S31600)		ASTM A276 (UNS S31600)	
17. Seat-Stem Seal	Group E (acc. item A.7.1.5.6)		Group E (acc. item A.7.1.5.6)		Group B (acc. item A.7.1.5.6)		Group B (acc. item A.7.1.5.6)	
18. Operator Type	2" - 3"	Lever	2" - 3"	Lever	2" - 3"	Lever	2" - 3"	Lever
	4" - 16"	Gearbox	4" - 16"	Gearbox	4" - 24"	Gearbox	4" - 24"	Gearbox
19. Additional Requirement	N/A		N/A		N/A		N/A	
20. Seat Type	Side A: SPE / Side B: SPE; DBB		Side A: SPE / Side B: DPE; DIB-2 & DBB		Side A: SPE / Side B: SPE; DBB		Side A: SPE / Side B: DPE; DIB-2 & DBB	
21. Bore Type	Full Bore		Full Bore		Full Bore		Full Bore	
22. Body Construction	split body, bolted		split body, bolted		split body, bolted		split body, bolted	
23. Cladding or Coating	N/A		N/A		N/A		N/A	
24. Valve Testing	FAT according A.9.3		FAT according A.9.3		FAT according A.9.3		FAT according A.9.3	
25. Notes	N/A		N/A		N/A		N/A	

Valve Code	VES-600-2-S224		VES-600-2-S228		VES-600-2-S234		VES-600-2-S238	
Specs	E3		E3		E3		E3	
1. Valve Type	Ball		Ball		Ball		Ball	
2. Sealing Type	Soft		Soft		Soft		Soft	
3. Valve Specification Level (VSL)	VSL-2		VSL-2		VSL-2		VSL-2	
4. Ball Mouting	Trunnion		Trunnion		Trunnion		Trunnion	
5. Standard	API 6D / IOGP S-562		API 6D / IOGP S-562		API 6D / IOGP S-562		API 6D / IOGP S-562	
6. Size Range (NPS)	2" - 24"		2" - 24"		2" - 24"		2" - 24"	
7. End Connection	ASME B16.5, RF		ASME B16.5, RF		ASME B16.5, RF		ASME B16.5, RF	
8. Pressure Class	600		600		600		600	
9. Temperature	0°C to 150°C		0°C to 150°C		-46°C to 150°C		-46°C to 150°C	
10. Material Class	Stainless Steel		Stainless Steel		Stainless Steel		Stainless Steel	
11. Body Material	ASTM A182 Gr F316 or ASTM A351 Gr CF8M		ASTM A182 Gr F316 or ASTM A351 Gr CF8M		ASTM A182 Gr F316 or ASTM A351 Gr CF8M		ASTM A182 Gr F316 or ASTM A351 Gr CF8M	
12. Obturator Material	AISI 316		AISI 316		AISI 316		AISI 316	
13. Seat Material	AISI 316		AISI 316		AISI 316		AISI 316	
14. Seat Insert	PEEK		PEEK		PEEK		PEEK	
15. Spring (Seat) Material	UNS N07750		UNS N07750		UNS N07750		UNS N07750	
16. Stem Material	ASTM A276 (UNS S31600)		ASTM A276 (UNS S31600)		ASTM A276 (UNS S31600)		ASTM A276 (UNS S31600)	
17. Seat-Stem Seal	Group C (acc. item A.7.1.5.6)		Group C (acc. item A.7.1.5.6)		Group E (acc. item A.7.1.5.6)		Group E (acc. item A.7.1.5.6)	
18. Operator Type	2" - 3"	Lever	2" - 3"	Lever	2" - 3"	Lever	2" - 3"	Lever
	4" - 24"	Gearbox						
19. Additional Requirement	N/A		N/A		N/A		N/A	
20. Seat Type	Side A: SPE / Side B: SPE; DBB		Side A: SPE / Side B: DPE; DIB-2 & DBB		Side A: SPE / Side B: SPE; DBB		Side A: SPE / Side B: DPE; DIB-2 & DBB	
21. Bore Type	Full Bore		Full Bore		Full Bore		Full Bore	
22. Body Construction	split body, bolted		split body, bolted		split body, bolted		split body, bolted	
23. Cladding or Coating	N/A		N/A		N/A		N/A	
24. Valve Testing	FAT according A.9.3		FAT according A.9.3		FAT according A.9.3		FAT according A.9.3	
25. Notes	N/A		N/A		N/A		N/A	

Valve Code	VES-600-2-S250		VES-600-2-S252		VES-600-2-S260		VES-600-2-S262	
Specs	E3		E3		E3		E3	
1. Valve Type	Ball		Ball		Ball		Ball	
2. Sealing Type	Metal to Metal		Metal to Metal		Metal to Metal		Metal to Metal	
3. Valve Specification Level (VSL)	VSL-2		VSL-2		VSL-2		VSL-2	
4. Ball Mouting	Trunnion		Trunnion		Trunnion		Trunnion	
5. Standard	API 6D / IOGP S-562		API 6D / IOGP S-562		API 6D		API 6D	
6. Size Range (NPS)	2" - 24"		2" - 24"		2" - 24"		2" - 24"	
7. End Connection	ASME B16.5, RF		ASME B16.5, RF		ASME B16.5, RF		ASME B16.5, RF	
8. Pressure Class	600		600		600		600	
9. Temperature	-30°C to 150°C		-30°C to 150°C		0°C to 210°C		0°C to 210°C	
10. Material Class	Stainless Steel		Stainless Steel		Stainless Steel		Stainless Steel	
11. Body Material	ASTM A182 Gr F316 or ASTM A351 Gr CF8M		ASTM A182 Gr F316 or ASTM A351 Gr CF8M		ASTM A182 Gr F316 or ASTM A351 Gr CF8M		ASTM A182 Gr F316 or ASTM A351 Gr CF8M	
12. Obturator Material	AISI 316 + Tungsten carbide coating		AISI 316 + Tungsten carbide coating		AISI 316 + Tungsten carbide coating		AISI 316 + Tungsten carbide coating	
13. Seat Material	AISI 316 + Tungsten carbide coating		AISI 316 + Tungsten carbide coating		AISI 316 + Tungsten carbide coating		AISI 316 + Tungsten carbide coating	
14. Seat Insert	N/A		N/A		N/A		N/A	
15. Spring (Seat) Material	UNS N07750		UNS N07750		UNS N07750		UNS N07750	
16. Stem Material	ASTM A276 (UNS S31600)		ASTM A276 (UNS S31600)		ASTM A276 (UNS S31600)		ASTM A276 (UNS S31600)	
17. Seat-Stem Seal	Group B (acc. item A.7.1.5.6)		Group B (acc. item A.7.1.5.6)		Group C (acc. item A.7.1.5.6)		Group C (acc. item A.7.1.5.6)	
18. Operator Type	2" - 3"	Lever	2" - 3"	Lever	2" - 3"	Lever	2" - 3"	Lever
	4" - 24"	Gearbox						
19. Additional Requirement	N/A		N/A		N/A		N/A	
20. Seat Type	Side A: SPE / Side B: SPE		Side A: SPE / Side B: DPE; DIB-2 & DBB		Side A: SPE / Side B: SPE		Side A: SPE / Side B: DPE; DIB-2 & DBB	
21. Bore Type	Full Bore		Full Bore		Full Bore		Full Bore	
22. Body Construction	split body, bolted		split body, bolted		split body, bolted		split body, bolted	
23. Cladding or Coating	N/A		N/A		N/A		N/A	
24. Valve Testing	FAT according A.9.3		FAT according A.9.3		FAT according A.9.3		FAT according A.9.3	
25. Notes	N/A		N/A		N/A		N/A	

Valve Code	VES-600-2-S270		VES-600-2-S272		VES-600-3-A572		VES-600-3-A573	
Specs	E3		E3		E32		E32	
1. Valve Type	Ball		Ball		Ball		Ball	
2. Sealing Type	Metal to Metal		Metal to Metal		Metal to Metal		Metal to Metal	
3. Valve Specification Level (VSL)	VSL-2		VSL-2		VSL-3		VSL-3	
4. Ball Mouting	Trunnion		Trunnion		Trunnion		Trunnion	
5. Standard	API 6D		API 6D		API 6D		API 6D	
6. Size Range (NPS)	2" - 24"		2" - 24"		2" - 16"		2" - 16"	
7. End Connection	ASME B16.5, RF		ASME B16.5, RF		ASME B16.5, RF		ASME B16.5, RF	
8. Pressure Class	600		600		600		600	
9. Temperature	-100°C to 200°C		-100°C to 200°C		-100°C to 200°C		-100°C to 200°C	
10. Material Class	Stainless Steel		Stainless Steel		Alloy Steel		Alloy Steel	
11. Body Material	ASTM A182 Gr F316 or ASTM A351 Gr CF8M		ASTM A182 Gr F316 or ASTM A351 Gr CF8M		ASTM A350 Gr LF3 + Inconel 625 weld overlay (acc. item A.7.1.7.3)		ASTM A350 Gr LF3 + Inconel 625 weld overlay (acc. item A.7.1.7.3)	
12. Obturator Material	AISI 316 + Tungsten carbide coating		AISI 316 + Tungsten carbide coating		ASTM A350 Gr LF3 + Inconel 625 weld overlay (acc. item A.7.1.7.3) + Tungsten carbide coating		ASTM A350 Gr LF3 + Inconel 625 weld overlay (acc. item A.7.1.7.3) + Tungsten carbide coating	
13. Seat Material	AISI 316 + Tungsten carbide coating		AISI 316 + Tungsten carbide coating		ASTM A350 Gr LF3 + Inconel 625 weld overlay (acc. item A.7.1.7.3) + Tungsten carbide coating		ASTM A350 Gr LF3 + Inconel 625 weld overlay (acc. item A.7.1.7.3) + Tungsten carbide coating	
14. Seat Insert	N/A		N/A		N/A		N/A	
15. Spring (Seat) Material	UNS N07750		UNS N07750		UNS N07750		UNS N07750	
16. Stem Material	ASTM A276 (UNS S31600)		ASTM A276 (UNS S31600)		ASTM B637 (UNS N07718)		ASTM B637 (UNS N07718)	
17. Seat-Stem Seal	Group E (acc. item A.7.1.5.6)		Group E (acc. item A.7.1.5.6)		Group E (acc. item A.7.1.5.6)		Group E (acc. item A.7.1.5.6)	
18. Operator Type	2" - 3"	Lever	2" - 3"	Lever	2" - 3"	Lever	2" - 3"	Lever
	4" - 24"	Gearbox	4" - 24"	Gearbox	4" - 16"	Gearbox	4" - 16"	Gearbox
19. Additional Requirement	N/A		N/A		N/A		Fire Tested (acc. item A.6.1.4)	
20. Seat Type	Side A: SPE / Side B: SPE		Side A: SPE / Side B: DPE; DIB-2 & DBB		Side A: SPE / Side B: DPE; DIB-2 & DBB		Side A: SPE / Side B: DPE; DIB-2 & DBB	
21. Bore Type	Full Bore		Full Bore		Full Bore		Full Bore	
22. Body Construction	split body, bolted		split body, bolted		split body, bolted		split body, bolted	
23. Cladding or Coating	N/A		N/A		Full clad - Inconel 625 weld overlay on all wetted parts		Full clad - Inconel 625 weld overlay on all wetted parts	
24. Valve Testing	FAT according A.9.3		FAT according A.9.3		FAT according A.9.3		FAT according A.9.3	
25. Notes	N/A		N/A		Acceptance criteria for sealing tests see Annex A		Acceptance criteria for sealing tests see Annex A	

Valve Code	VES-600-3-A582		VES-600-3-A583		VES-600-3-C118		VES-600-3-C119	
Specs	E32		E32		E9 E10		E9 E10	
1. Valve Type	Ball		Ball		Ball		Ball	
2. Sealing Type	Metal to Metal		Metal to Metal		Soft		Soft	
3. Valve Specification Level (VSL)	VSL-3		VSL-3		VSL-3		VSL-3	
4. Ball Mouting	Trunnion		Trunnion		Trunnion		Trunnion	
5. Standard	API 6D		API 6D		API 6D / IOGP S-562		API 6D / IOGP S-562	
6. Size Range (NPS)	2" - 16"		2" - 16"		2" - 24"		2" - 24"	
7. End Connection	ASME B16.5, RF		ASME B16.5, RF		ASME B16.5, RF		ASME B16.5, RF	
8. Pressure Class	600		600		600		600	
9. Temperature	-100°C to 400°C		-100°C to 400°C		-29°C to 150°C		-29°C to 150°C	
10. Material Class	Alloy Steel		Alloy Steel		Carbon Steel		Carbon Steel	
11. Body Material	ASTM A350 Gr LF3 + Inconel 625 weld overlay (acc. item A.7.1.7.3)		ASTM A350 Gr LF3 + Inconel 625 weld overlay (acc. item A.7.1.7.3)		ASTM A105 + SS316 weld overlay (acc. item A.7.1.7.3)		ASTM A105 + SS316 weld overlay (acc. item A.7.1.7.3)	
12. Obturator Material	ASTM A350 Gr LF3 + Inconel 625 weld overlay (acc. item A.7.1.7.3) + Chrome-Nickel Spray and Fuse (acc. Item A.8.2.2.4)		ASTM A350 Gr LF3 + Inconel 625 weld overlay (acc. item A.7.1.7.3) + Chrome-Nickel Spray and Fuse (acc. Item A.8.2.2.4)		AISI 410		AISI 410	
13. Seat Material	ASTM A350 Gr LF3 + Inconel 625 weld overlay (acc. item A.7.1.7.3) + Chrome-Nickel Spray and Fuse (acc. Item A.8.2.2.4)		ASTM A350 Gr LF3 + Inconel 625 weld overlay (acc. item A.7.1.7.3) + Chrome-Nickel Spray and Fuse (acc. Item A.8.2.2.4)		AISI 410		AISI 410	
14. Seat Insert	N/A		N/A		PEEK		PEEK	
15. Spring (Seat) Material	UNS N07750		UNS N07750		UNS N07750		UNS N07750	
16. Stem Material	ASTM B637 (UNS N07718)		ASTM B637 (UNS N07718)		ASTM A276 (UNS S41000)		ASTM A276 (UNS S41000)	
17. Seat-Stem Seal	Group F (acc. item A.7.1.5.6)		Group F (acc. item A.7.1.5.6)		Group B (acc. item A.7.1.5.6)		Group B (acc. item A.7.1.5.6)	
18. Operator Type	2" - 3"	Lever	2" - 3"	Lever	2" - 3"	Lever	2" - 3"	Lever
	4" - 16"	Gearbox	4" - 16"	Gearbox	4" - 24"	Gearbox	4" - 24"	Gearbox
19. Additional Requirement	N/A		Fire Tested (acc. item A.6.1.4)		N/A		Fire Tested (acc. item A.6.1.4)	
20. Seat Type	Side A: SPE / Side B: DPE; DIB-2 & DBB		Side A: SPE / Side B: DPE; DIB-2 & DBB		Side A: SPE / Side B: DPE; DIB-2 & DBB		Side A: SPE / Side B: DPE; DIB-2 & DBB	
21. Bore Type	Full Bore		Full Bore		Full Bore		Full Bore	
22. Body Construction	split body, bolted		split body, bolted		split body, bolted		split body, bolted	
23. Cladding or Coating	Full clad - Inconel 625 weld overlay on all wetted parts		Full clad - Inconel 625 weld overlay on all wetted parts		Partial clad - SS316 weld overlay on all body sealing areas		Partial clad - SS316 weld overlay on all body sealing areas	
24. Valve Testing	FAT according A.9.3		FAT according A.9.3		FAT according A.9.3		FAT according A.9.3	
25. Notes	Acceptance criteria for sealing tests see Annex A		Acceptance criteria for sealing tests see Annex A		N/A		N/A	

Valve Code	VES-600-3-C128		VES-600-3-C129		VES-600-3-C138		VES-600-3-C139	
Specs	E9 E10		E10		E9 E10		E9 E10	
1. Valve Type	Ball		Ball		Ball		Ball	
2. Sealing Type	Soft		Soft		Soft		Soft	
3. Valve Specification Level (VSL)	VSL-3		VSL-3		VSL-3		VSL-3	
4. Ball Mouting	Trunnion		Trunnion		Trunnion		Trunnion	
5. Standard	API 6D / IOGP S-562		API 6D / IOGP S-562		API 6D / IOGP S-562		API 6D / IOGP S-562	
6. Size Range (NPS)	2" - 24"		2" - 24"		2" - 24"		2" - 24"	
7. End Connection	ASME B16.5, RF		ASME B16.5, RF		ASME B16.5, RF		ASME B16.5, RF	
8. Pressure Class	600		600		600		600	
9. Temperature	0°C to 150°C		0°C to 150°C		0°C to 150°C		-29°C to 150°C	
10. Material Class	Carbon Steel		Carbon Steel		Carbon Steel		Carbon Steel	
11. Body Material	ASTM A105 + SS316 weld overlay (acc. item A.7.1.7.3)		ASTM A105 + SS316 weld overlay (acc. item A.7.1.7.3)		ASTM A105 + SS316 weld overlay (acc. item A.7.1.7.3)		ASTM A105 + SS316 weld overlay (acc. item A.7.1.7.3)	
12. Obturator Material	AISI 410		AISI 410		AISI 410		AISI 410	
13. Seat Material	AISI 410		AISI 410		AISI 410		AISI 410	
14. Seat Insert	PEEK		PEEK		PEEK		PEEK	
15. Spring (Seat) Material	UNS N07750		UNS N07750		UNS N07750		UNS N07750	
16. Stem Material	ASTM A276 (UNS S41000)		ASTM A276 (UNS S41000)		ASTM A276 (UNS S41000)		ASTM A276 (UNS S41000)	
17. Seat-Stem Seal	Group C (acc. item A.7.1.5.6)		Group C (acc. item A.7.1.5.6)		Group D (acc. item A.7.1.5.6)		Group E (acc. item A.7.1.5.6)	
18. Operator Type	2" - 3"	Lever	2" - 3"	Lever	2" - 3"	Lever	2" - 3"	Lever
	4" - 24"	Gearbox	4" - 24"	Gearbox	4" - 24"	Gearbox	4" - 24"	Gearbox
19. Additional Requirement	N/A		Fire Tested (acc. item A.6.1.4)		N/A		Fire Tested (acc. item A.6.1.4)	
20. Seat Type	Side A: SPE / Side B: DPE; DIB-2 & DBB		Side A: SPE / Side B: DPE; DIB-2 & DBB		Side A: SPE / Side B: DPE; DIB-2 & DBB		Side A: SPE / Side B: DPE; DIB-2 & DBB	
21. Bore Type	Full Bore		Full Bore		Full Bore		Full Bore	
22. Body Construction	split body, bolted		split body, bolted		split body, bolted		split body, bolted	
23. Cladding or Coating	Partial clad - SS316 weld overlay on all body sealing areas		Partial clad - SS316 weld overlay on all body sealing areas		Partial clad - SS316 weld overlay on all body sealing areas		Partial clad - SS316 weld overlay on all body sealing areas	
24. Valve Testing	FAT according A.9.3		FAT according A.9.3		FAT according A.9.3		FAT according A.9.3	
25. Notes	N/A		N/A		N/A		N/A	

Valve Code	VES-600-3-C152		VES-600-3-C153		VES-600-3-C162		VES-600-3-C163	
Specs	E9 E10		E9 E10		E9 E10		E9 E10	
1. Valve Type	Ball		Ball		Ball		Ball	
2. Sealing Type	Metal to Metal		Metal to Metal		Metal to Metal		Metal to Metal	
3. Valve Specification Level (VSL)	VSL-3		VSL-3		VSL-3		VSL-3	
4. Ball Mouting	Trunnion		Trunnion		Trunnion		Trunnion	
5. Standard	API 6D / IOGP S-562		API 6D / IOGP S-562		API 6D		API 6D	
6. Size Range (NPS)	2" - 24"		2" - 24"		2" - 24"		2" - 24"	
7. End Connection	ASME B16.5, RF		ASME B16.5, RF		ASME B16.5, RF		ASME B16.5, RF	
8. Pressure Class	600		600		600		600	
9. Temperature	0°C to 150°C		-29°C to 150°C		0°C to 210°C		0°C to 210°C	
10. Material Class	Carbon Steel		Carbon Steel		Carbon Steel		Carbon Steel	
11. Body Material	ASTM A105 + SS316 weld overlay (acc. item A.7.1.7.3)		ASTM A105 + SS316 weld overlay (acc. item A.7.1.7.3)		ASTM A105 + SS316 weld overlay (acc. item A.7.1.7.3)		ASTM A105 + SS316 weld overlay (acc. item A.7.1.7.3)	
12. Obturator Material	AISI 410 + Tungsten carbide coating		AISI 410 + Tungsten carbide coating		AISI 410 + Tungsten carbide coating		AISI 410 + Tungsten carbide coating	
13. Seat Material	AISI 410 + Tungsten carbide coating		AISI 410 + Tungsten carbide coating		AISI 410 + Tungsten carbide coating		AISI 410 + Tungsten carbide coating	
14. Seat Insert	N/A		N/A		N/A		N/A	
15. Spring (Seat) Material	UNS N07750		UNS N07750		UNS N07750		UNS N07750	
16. Stem Material	ASTM A276 (UNS S41000)		ASTM A276 (UNS S41000)		ASTM A276 (UNS S41000)		ASTM A276 (UNS S41000)	
17. Seat-Stem Seal	Group A (acc. item A.7.1.5.6)		Group B (acc. item A.7.1.5.6)		Group C (acc. item A.7.1.5.6)		Group C (acc. item A.7.1.5.6)	
18. Operator Type	2" - 3"	Lever	2" - 3"	Lever	2" - 3"	Lever	2" - 3"	Lever
	4" - 24"	Gearbox	4" - 24"	Gearbox	4" - 24"	Gearbox	4" - 24"	Gearbox
19. Additional Requirement	N/A		Fire Tested (acc. item A.6.1.4)		N/A		Fire Tested (acc. item A.6.1.4)	
20. Seat Type	Side A: SPE / Side B: DPE; DIB-2 & DBB		Side A: SPE / Side B: DPE; DIB-2 & DBB		Side A: SPE / Side B: DPE; DIB-2 & DBB		Side A: SPE / Side B: DPE; DIB-2 & DBB	
21. Bore Type	Full Bore		Full Bore		Full Bore		Full Bore	
22. Body Construction	split body, bolted		split body, bolted		split body, bolted		split body, bolted	
23. Cladding or Coating	Partial clad - SS316 weld overlay on all body sealing areas		Partial clad - SS316 weld overlay on all body sealing areas		Partial clad - SS316 weld overlay on all body sealing areas		Partial clad - SS316 weld overlay on all body sealing areas	
24. Valve Testing	FAT according A.9.3		FAT according A.9.3		FAT according A.9.3		FAT according A.9.3	
25. Notes	Acceptance criteria for sealing tests see Annex A		Acceptance criteria for sealing tests see Annex A		Acceptance criteria for sealing tests see Annex A		Acceptance criteria for sealing tests see Annex A	

Valve Code	VES-600-3-C172		VES-600-3-C173		VES-600-3-C218		VES-600-3-C219	
Specs	E9 E10		E9 E10		E6 E19		E6 E19	
1. Valve Type	Ball		Ball		Ball		Ball	
2. Sealing Type	Metal to Metal		Metal to Metal		Soft		Soft	
3. Valve Specification Level (VSL)	VSL-3		VSL-3		VSL-3		VSL-3	
4. Ball Mouting	Trunnion		Trunnion		Trunnion		Trunnion	
5. Standard	API 6D		API 6D		API 6D / IOGP S-562		API 6D / IOGP S-562	
6. Size Range (NPS)	2" - 24"		2" - 24"		2" - 24"		2" - 24"	
7. End Connection	ASME B16.5, RF		ASME B16.5, RF		ASME B16.5, RF		ASME B16.5, RF	
8. Pressure Class	600		600		600		600	
9. Temperature	0°C to 210°C		-29°C to 200°C		-30°C to 150°C		-30°C to 150°C	
10. Material Class	Carbon Steel		Carbon Steel		Carbon Steel		Carbon Steel	
11. Body Material	ASTM A105 + SS316 weld overlay (acc. item A.7.1.7.3)		ASTM A105 + SS316 weld overlay (acc. item A.7.1.7.3)		ASTM A350 Gr LF2 CL1 + Inconel 625 weld overlay (acc. item A.7.1.7.3)		ASTM A350 Gr LF2 CL1 + Inconel 625 weld overlay (acc. item A.7.1.7.3)	
12. Obturator Material	AISI 410 + Tungsten carbide coating		AISI 410 + Tungsten carbide coating		AISI 316		AISI 316	
13. Seat Material	AISI 410 + Tungsten carbide coating		AISI 410 + Tungsten carbide coating		AISI 316		AISI 316	
14. Seat Insert	N/A		N/A		PEEK		PEEK	
15. Spring (Seat) Material	UNS N07750		UNS N07750		UNS N07750		UNS N07750	
16. Stem Material	ASTM A276 (UNS S41000)		ASTM A276 (UNS S41000)		ASTM A276 (UNS S31600)		ASTM A276 (UNS S31600)	
17. Seat-Stem Seal	Group D (acc. item A.7.1.5.6)		Group E (acc. item A.7.1.5.6)		Group B (acc. item A.7.1.5.6)		Group B (acc. item A.7.1.5.6)	
18. Operator Type	2" - 3"	Lever	2" - 3"	Lever	2" - 3"	Lever	2" - 3"	Lever
	4" - 24"	Gearbox	4" - 24"	Gearbox	4" - 24"	Gearbox	4" - 24"	Gearbox
19. Additional Requirement	N/A		Fire Tested (acc. item A.6.1.4)		N/A		Fire Tested (acc. item A.6.1.4)	
20. Seat Type	Side A: SPE / Side B: DPE; DIB-2 & DBB		Side A: SPE / Side B: DPE; DIB-2 & DBB		Side A: SPE / Side B: DPE; DIB-2 & DBB		Side A: SPE / Side B: DPE; DIB-2 & DBB	
21. Bore Type	Full Bore		Full Bore		Full Bore		Full Bore	
22. Body Construction	split body, bolted		split body, bolted		split body, bolted		split body, bolted	
23. Cladding or Coating	Partial clad - SS316 weld overlay on all body sealing areas		Partial clad - SS316 weld overlay on all body sealing areas		Partial clad - Inconel 625 weld overlay on all body sealing areas		Partial clad - Inconel 625 weld overlay on all body sealing areas	
24. Valve Testing	FAT according A.9.3		FAT according A.9.3		FAT according A.9.3		FAT according A.9.3	
25. Notes	Acceptance criteria for sealing tests see Annex A		Acceptance criteria for sealing tests see Annex A		N/A		N/A	

Valve Code	VES-600-3-C238		VES-600-3-C239		VES-600-3-C252		VES-600-3-C253	
Specs	E6 E19		E6 E19		E6 E19		E6 E19	
1. Valve Type	Ball		Ball		Ball		Ball	
2. Sealing Type	Soft		Soft		Metal to Metal		Metal to Metal	
3. Valve Specification Level (VSL)	VSL-3		VSL-3		VSL-3		VSL-3	
4. Ball Mouting	Trunnion		Trunnion		Trunnion		Trunnion	
5. Standard	API 6D / IOGP S-562		API 6D / IOGP S-562		API 6D / IOGP S-562		API 6D / IOGP S-562	
6. Size Range (NPS)	2" - 24"		2" - 24"		2" - 24"		2" - 24"	
7. End Connection	ASME B16.5, RF		ASME B16.5, RF		ASME B16.5, RF		ASME B16.5, RF	
8. Pressure Class	600		600		600		600	
9. Temperature	-46°C to 150°C		-46°C to 150°C		-30°C to 150°C		-30°C to 150°C	
10. Material Class	Carbon Steel		Carbon Steel		Carbon Steel		Carbon Steel	
11. Body Material	ASTM A350 Gr LF2 CL1 + Inconel 625 weld overlay (acc. item A.7.1.7.3)		ASTM A350 Gr LF2 CL1 + Inconel 625 weld overlay (acc. item A.7.1.7.3)		ASTM A350 Gr LF2 CL1 + Inconel 625 weld overlay (acc. item A.7.1.7.3)		ASTM A350 Gr LF2 CL1 + Inconel 625 weld overlay (acc. item A.7.1.7.3)	
12. Obturator Material	AISI 316		AISI 316		AISI 316 + Tungsten carbide coating		AISI 316 + Tungsten carbide coating	
13. Seat Material	AISI 316		AISI 316		AISI 316 + Tungsten carbide coating		AISI 316 + Tungsten carbide coating	
14. Seat Insert	PEEK		PEEK		N/A		N/A	
15. Spring (Seat) Material	UNS N07750		UNS N07750		UNS N07750		UNS N07750	
16. Stem Material	ASTM A276 (UNS S31600)		ASTM A276 (UNS S31600)		ASTM A276 (UNS S31600)		ASTM A276 (UNS S31600)	
17. Seat-Stem Seal	Group E (acc. item A.7.1.5.6)		Group E (acc. item A.7.1.5.6)		Group B (acc. item A.7.1.5.6)		Group B (acc. item A.7.1.5.6)	
18. Operator Type	2" - 3"	Lever	2" - 3"	Lever	2" - 3"	Lever	2" - 3"	Lever
	4" - 24"	Gearbox	4" - 24"	Gearbox	4" - 24"	Gearbox	4" - 24"	Gearbox
19. Additional Requirement	N/A		Fire Tested (acc. item A.6.1.4)		N/A		Fire Tested (acc. item A.6.1.4)	
20. Seat Type	Side A: SPE / Side B: DPE; DIB-2 & DBB		Side A: SPE / Side B: DPE; DIB-2 & DBB		Side A: SPE / Side B: DPE; DIB-2 & DBB		Side A: SPE / Side B: DPE; DIB-2 & DBB	
21. Bore Type	Full Bore		Full Bore		Full Bore		Full Bore	
22. Body Construction	split body, bolted		split body, bolted		split body, bolted		split body, bolted	
23. Cladding or Coating	Partial clad - Inconel 625 weld overlay on all body sealing areas		Partial clad - Inconel 625 weld overlay on all body sealing areas		Partial clad - Inconel 625 weld overlay on all body sealing areas		Partial clad - Inconel 625 weld overlay on all body sealing areas	
24. Valve Testing	FAT according A.9.3		FAT according A.9.3		FAT according A.9.3		FAT according A.9.3	
25. Notes	N/A		N/A		Acceptance criteria for sealing tests see Annex A		Acceptance criteria for sealing tests see Annex A	

Valve Code	VES-600-3-C272		VES-600-3-C273		VES-600-3-C553		VES-600-3-C562	
Specs	E6 E19		E6 E19		E30		E30	
1. Valve Type	Ball		Ball		Ball		Ball	
2. Sealing Type	Metal to Metal		Metal to Metal		Metal to Metal		Metal to Metal	
3. Valve Specification Level (VSL)	VSL-3		VSL-3		VSL-3		VSL-3	
4. Ball Mouting	Trunnion		Trunnion		Trunnion		Trunnion	
5. Standard	API 6D / IOGP S-562		API 6D		API 6D / IOGP S-562		API 6D	
6. Size Range (NPS)	2" - 24"		2" - 24"		2" - 20"		2" - 20"	
7. End Connection	ASME B16.5, RF		ASME B16.5, RF		ASME B16.5, RF		ASME B16.5, RF	
8. Pressure Class	600		600		600		600	
9. Temperature	-30°C to 150°C		-46°C to 200°C		-29°C to 150°C		0°C to 210°C	
10. Material Class	Carbon Steel		Carbon Steel		Carbon Steel		Carbon Steel	
11. Body Material	ASTM A350 Gr LF2 CL1 + Inconel 625 weld overlay (acc. item A.7.1.7.3)		ASTM A350 Gr LF2 CL1 + Inconel 625 weld overlay (acc. item A.7.1.7.3)		ASTM A105 + Inconel 625 weld overlay (acc. item A.7.1.7.3)		ASTM A105 + Inconel 625 weld overlay (acc. item A.7.1.7.3)	
12. Obturator Material	AISI 316 + Tungsten carbide coating		AISI 316 + Tungsten carbide coating		ASTM A105 + Inconel 625 weld overlay (acc. item A.7.1.7.3) + Tungsten carbide coating		ASTM A105 + Inconel 625 weld overlay (acc. item A.7.1.7.3) + Tungsten carbide coating	
13. Seat Material	AISI 316 + Tungsten carbide coating		AISI 316 + Tungsten carbide coating		ASTM A105 + Inconel 625 weld overlay (acc. item A.7.1.7.3) + Tungsten carbide coating		ASTM A105 + Inconel 625 weld overlay (acc. item A.7.1.7.3) + Tungsten carbide coating	
14. Seat Insert	N/A		N/A		N/A		N/A	
15. Spring (Seat) Material	UNS N07750		UNS N07750		UNS N07750		UNS N07750	
16. Stem Material	ASTM A276 (UNS S31600)		ASTM A276 (UNS S31600)		ASTM B637 (UNS N07718)		ASTM B637 (UNS N07718)	
17. Seat-Stem Seal	Group E (acc. item A.7.1.5.6)		Group E (acc. item A.7.1.5.6)		Group B (acc. item A.7.1.5.6)		Group C (acc. item A.7.1.5.6)	
18. Operator Type	2" - 3"	Lever	2" - 3"	Lever	2" - 3"	Lever	2" - 3"	Lever
	4" - 24"	Gearbox	4" - 24"	Gearbox	4" - 20"	Gearbox	4" - 20"	Gearbox
19. Additional Requirement	N/A		Fire Tested (acc. item A.6.1.4)		Fire Tested (acc. item A.6.1.4)		N/A	
20. Seat Type	Side A: SPE / Side B: DPE; DIB-2 & DBB		Side A: SPE / Side B: DPE; DIB-2 & DBB		Side A: SPE / Side B: DPE; DIB-2 & DBB		Side A: SPE / Side B: DPE; DIB-2 & DBB	
21. Bore Type	Full Bore		Full Bore		Full Bore		Full Bore	
22. Body Construction	split body, bolted		split body, bolted		split body, bolted		split body, bolted	
23. Cladding or Coating	Partial clad - Inconel 625 weld overlay on all body sealing areas		Partial clad - Inconel 625 weld overlay on all body sealing areas		Full clad - Inconel 625 weld overlay on all wetted parts		Full clad - Inconel 625 weld overlay on all wetted parts	
24. Valve Testing	FAT according A.9.3		FAT according A.9.3		FAT according A.9.3		FAT according A.9.3	
25. Notes	Acceptance criteria for sealing tests see Annex A		Acceptance criteria for sealing tests see Annex A		Acceptance criteria for sealing tests see Annex A		Acceptance criteria for sealing tests see Annex A	

Valve Code	VES-600-3-C563		VES-600-3-C572		VES-600-3-C573		VES-600-3-C582	
Specs	E30		E30		E30		E30	
1. Valve Type	Ball		Ball		Ball		Ball	
2. Sealing Type	Metal to Metal		Metal to Metal		Metal to Metal		Metal to Metal	
3. Valve Specification Level (VSL)	VSL-3		VSL-3		VSL-3		VSL-3	
4. Ball Mouting	Trunnion		Trunnion		Trunnion		Trunnion	
5. Standard	API 6D		API 6D		API 6D		API 6D	
6. Size Range (NPS)	2" - 20"		2" - 20"		2" - 20"		2" - 20"	
7. End Connection	ASME B16.5, RF		ASME B16.5, RF		ASME B16.5, RF		ASME B16.5, RF	
8. Pressure Class	600		600		600		600	
9. Temperature	0°C to 210°C		0°C to 210°C		0°C to 210°C		0°C to 400°C	
10. Material Class	Carbon Steel		Carbon Steel		Carbon Steel		Carbon Steel	
11. Body Material	ASTM A105 + Inconel 625 weld overlay (acc. item A.7.1.7.3)		ASTM A105 + Inconel 625 weld overlay (acc. item A.7.1.7.3)		ASTM A105 + Inconel 625 weld overlay (acc. item A.7.1.7.3)		ASTM A105 + Inconel 625 weld overlay (acc. item A.7.1.7.3)	
12. Obturator Material	ASTM A105 + Inconel 625 weld overlay (acc. item A.7.1.7.3) + Tungsten carbide coating		ASTM A105 + Inconel 625 weld overlay (acc. item A.7.1.7.3) + Tungsten carbide coating		ASTM A105 + Inconel 625 weld overlay (acc. item A.7.1.7.3) + Tungsten carbide coating		ASTM A105 + Inconel 625 weld overlay (acc. item A.7.1.7.3) + Chrome-Nickel Spray and Fuse (acc. Item A.8.2.2.4)	
13. Seat Material	ASTM A105 + Inconel 625 weld overlay (acc. item A.7.1.7.3) + Tungsten carbide coating		ASTM A105 + Inconel 625 weld overlay (acc. item A.7.1.7.3) + Tungsten carbide coating		ASTM A105 + Inconel 625 weld overlay (acc. item A.7.1.7.3) + Tungsten carbide coating		ASTM A105 + Inconel 625 weld overlay (acc. item A.7.1.7.3) + Chrome-Nickel Spray and Fuse (acc. Item A.8.2.2.4)	
14. Seat Insert	N/A		N/A		N/A		N/A	
15. Spring (Seat) Material	UNS N07750		UNS N07750		UNS N07750		UNS N07750	
16. Stem Material	ASTM B637 (UNS N07718)		ASTM B637 (UNS N07718)		ASTM B637 (UNS N07718)		ASTM B637 (UNS N07718)	
17. Seat-Stem Seal	Group C (acc. item A.7.1.5.6)		Group D (acc. item A.7.1.5.6)		Group D (acc. item A.7.1.5.6)		Group F (acc. item A.7.1.5.6)	
18. Operator Type	2" - 3"	Lever	2" - 3"	Lever	2" - 3"	Lever	2" - 3"	Lever
	4" - 20"	Gearbox	4" - 20"	Gearbox	4" - 20"	Gearbox	4" - 20"	Gearbox
19. Additional Requirement	Fire Tested (acc. item A.6.1.4)		N/A		Fire Tested (acc. item A.6.1.4)		N/A	
20. Seat Type	Side A: SPE / Side B: DPE; DIB-2 & DBB		Side A: SPE / Side B: DPE; DIB-2 & DBB		Side A: SPE / Side B: DPE; DIB-2 & DBB		Side A: SPE / Side B: DPE; DIB-2 & DBB	
21. Bore Type	Full Bore		Full Bore		Full Bore		Full Bore	
22. Body Construction	split body, bolted		split body, bolted		split body, bolted		split body, bolted	
23. Cladding or Coating	Full clad - Inconel 625 weld overlay on all wetted parts		Full clad - Inconel 625 weld overlay on all wetted parts		Full clad - Inconel 625 weld overlay on all wetted parts		Full clad - Inconel 625 weld overlay on all wetted parts	
24. Valve Testing	FAT according A.9.3		FAT according A.9.3		FAT according A.9.3		FAT according A.9.3	
25. Notes	Acceptance criteria for sealing tests see Annex A		Acceptance criteria for sealing tests see Annex A		Acceptance criteria for sealing tests see Annex A		Acceptance criteria for sealing tests see Annex A	

Valve Code	VES-600-3-C583		VES-600-3-D218		VES-600-3-D219		VES-600-3-D228	
Specs	E30		E16		E16		E16	
1. Valve Type	Ball		Ball		Ball		Ball	
2. Sealing Type	Metal to Metal		Soft		Soft		Soft	
3. Valve Specification Level (VSL)	VSL-3		VSL-3		VSL-3		VSL-3	
4. Ball Mouting	Trunnion		Trunnion		Trunnion		Trunnion	
5. Standard	API 6D		API 6D / IOGP S-562		API 6D / IOGP S-562		API 6D / IOGP S-562	
6. Size Range (NPS)	2" - 20"		2" - 16"		2" - 16"		2" - 16"	
7. End Connection	ASME B16.5, RF		ASME B16.5, RF		ASME B16.5, RF		ASME B16.5, RF	
8. Pressure Class	600		600		600		600	
9. Temperature	0°C to 400°C		-30°C to 150°C		-30°C to 150°C		0°C to 150°C	
10. Material Class	Carbon Steel		Duplex Steel		Duplex Steel		Duplex Steel	
11. Body Material	ASTM A105 + Inconel 625 weld overlay (acc. item A.7.1.7.3)		ASTM A182 Gr F51		ASTM A182 Gr F51		ASTM A182 Gr F51	
12. Obturator Material	ASTM A105 + Inconel 625 weld overlay (acc. item A.7.1.7.3) + Chrome-Nickel Spray and Fuse (acc. Item A.8.2.2.4)		Duplex (UNS S31803)		Duplex (UNS S31803)		Duplex (UNS S31803)	
13. Seat Material	ASTM A105 + Inconel 625 weld overlay (acc. item A.7.1.7.3) + Chrome-Nickel Spray and Fuse (acc. Item A.8.2.2.4)		Duplex (UNS S31803)		Duplex (UNS S31803)		Duplex (UNS S31803)	
14. Seat Insert	N/A		PEEK		PEEK		PEEK	
15. Spring (Seat) Material	UNS N07750		UNS N07750		UNS N07750		UNS N07750	
16. Stem Material	ASTM B637 (UNS N07718)		ASTM A276 (UNS S31803)		ASTM A276 (UNS S31803)		ASTM A276 (UNS S31803)	
17. Seat-Stem Seal	Group F (acc. item A.7.1.5.6)		Group B (acc. item A.7.1.5.6)		Group B (acc. item A.7.1.5.6)		Group C (acc. item A.7.1.5.6)	
18. Operator Type	2" - 3"	Lever	2" - 3"	Lever	2" - 3"	Lever	2" - 3"	Lever
	4" - 20"	Gearbox	4" - 16"	Gearbox	4" - 16"	Gearbox	4" - 16"	Gearbox
19. Additional Requirement	Fire Tested (acc. item A.6.1.4)		N/A		Fire Tested (acc. item A.6.1.4)		N/A	
20. Seat Type	Side A: SPE / Side B: DPE; DIB-2 & DBB		Side A: SPE / Side B: DPE; DIB-2 & DBB		Side A: SPE / Side B: DPE; DIB-2 & DBB		Side A: SPE / Side B: DPE; DIB-2 & DBB	
21. Bore Type	Full Bore		Full Bore		Full Bore		Full Bore	
22. Body Construction	split body, bolted		split body, bolted		split body, bolted		split body, bolted	
23. Cladding or Coating	Full clad - Inconel 625 weld overlay on all wetted parts		N/A		N/A		N/A	
24. Valve Testing	FAT according A.9.3		FAT according A.9.3		FAT according A.9.3		FAT according A.9.3	
25. Notes	Acceptance criteria for sealing tests see Annex A		N/A		N/A		N/A	

Valve Code	VES-600-3-D229		VES-600-3-D238		VES-600-3-D239		VES-600-3-D252	
Specs	E16		E16		E16		E16	
1. Valve Type	Ball		Ball		Ball		Ball	
2. Sealing Type	Soft		Soft		Soft		Metal to Metal	
3. Valve Specification Level (VSL)	VSL-3		VSL-3		VSL-3		VSL-3	
4. Ball Mouting	Trunnion		Trunnion		Trunnion		Trunnion	
5. Standard	API 6D / IOGP S-562		API 6D / IOGP S-562		API 6D / IOGP S-562		API 6D / IOGP S-562	
6. Size Range (NPS)	2" - 16"		2" - 16"		2" - 16"		2" - 16"	
7. End Connection	ASME B16.5, RF		ASME B16.5, RF		ASME B16.5, RF		ASME B16.5, RF	
8. Pressure Class	600		600		600		600	
9. Temperature	0°C to 150°C		-46°C to 150°C		-46°C to 150°C		-30°C to 150°C	
10. Material Class	Duplex Steel		Duplex Steel		Duplex Steel		Duplex Steel	
11. Body Material	ASTM A182 Gr F51		ASTM A182 Gr F51		ASTM A182 Gr F51		ASTM A182 Gr F51	
12. Obturator Material	Duplex (UNS S31803)		Duplex (UNS S31803)		Duplex (UNS S31803)		Duplex (UNS S31803) + Tungsten carbide coating	
13. Seat Material	Duplex (UNS S31803)		Duplex (UNS S31803)		Duplex (UNS S31803)		Duplex (UNS S31803) + Tungsten carbide coating	
14. Seat Insert	PEEK		PEEK		PEEK		N/A	
15. Spring (Seat) Material	UNS N07750		UNS N07750		UNS N07750		UNS N07750	
16. Stem Material	ASTM A276 (UNS S31803)		ASTM A276 (UNS S31803)		ASTM A276 (UNS S31803)		ASTM A276 (UNS S31803)	
17. Seat-Stem Seal	Group C (acc. item A.7.1.5.6)		Group E (acc. item A.7.1.5.6)		Group E (acc. item A.7.1.5.6)		Group B (acc. item A.7.1.5.6)	
18. Operator Type	2" - 3"	Lever	2" - 3"	Lever	2" - 3"	Lever	2" - 3"	Lever
	4" - 16"	Gearbox	4" - 16"	Gearbox	4" - 16"	Gearbox	4" - 16"	Gearbox
19. Additional Requirement	Fire Tested (acc. item A.6.1.4)		N/A		Fire Tested (acc. item A.6.1.4)		N/A	
20. Seat Type	Side A: SPE / Side B: DPE; DIB-2 & DBB		Side A: SPE / Side B: DPE; DIB-2 & DBB		Side A: SPE / Side B: DPE; DIB-2 & DBB		Side A: SPE / Side B: DPE; DIB-2 & DBB	
21. Bore Type	Full Bore		Full Bore		Full Bore		Full Bore	
22. Body Construction	split body, bolted		split body, bolted		split body, bolted		split body, bolted	
23. Cladding or Coating	N/A		N/A		N/A		N/A	
24. Valve Testing	FAT according A.9.3		FAT according A.9.3		FAT according A.9.3		FAT according A.9.3	
25. Notes	N/A		N/A		N/A		Acceptance criteria for sealing tests see Annex A	

Valve Code	VES-600-3-D253		VES-600-3-D262		VES-600-3-D263		VES-600-3-D272	
Specs	E16		E16		E16		E16	
1. Valve Type	Ball		Ball		Ball		Ball	
2. Sealing Type	Metal to Metal		Metal to Metal		Metal to Metal		Metal to Metal	
3. Valve Specification Level (VSL)	VSL-3		VSL-3		VSL-3		VSL-3	
4. Ball Mouting	Trunnion		Trunnion		Trunnion		Trunnion	
5. Standard	API 6D / IOGP S-562		API 6D / IOGP S-562		API 6D / IOGP S-562		API 6D / IOGP S-562	
6. Size Range (NPS)	2" - 16"		2" - 16"		2" - 16"		2" - 16"	
7. End Connection	ASME B16.5, RF		ASME B16.5, RF		ASME B16.5, RF		ASME B16.5, RF	
8. Pressure Class	600		600		600		600	
9. Temperature	-30°C to 150°C		0°C to 150°C		0°C to 150°C		-46°C to 150°C	
10. Material Class	Duplex Steel		Duplex Steel		Duplex Steel		Duplex Steel	
11. Body Material	ASTM A182 Gr F51		ASTM A182 Gr F51		ASTM A182 Gr F51		ASTM A182 Gr F51	
12. Obturator Material	Duplex (UNS S31803) + Tungsten carbide coating		Duplex (UNS S31803) + Tungsten carbide coating		Duplex (UNS S31803) + Tungsten carbide coating		Duplex (UNS S31803) + Tungsten carbide coating	
13. Seat Material	Duplex (UNS S31803) + Tungsten carbide coating		Duplex (UNS S31803) + Tungsten carbide coating		Duplex (UNS S31803) + Tungsten carbide coating		Duplex (UNS S31803) + Tungsten carbide coating	
14. Seat Insert	N/A		N/A		N/A		N/A	
15. Spring (Seat) Material	UNS N07750		UNS N07750		UNS N07750		UNS N07750	
16. Stem Material	ASTM A276 (UNS S31803)		ASTM A276 (UNS S31803)		ASTM A276 (UNS S31803)		ASTM A276 (UNS S31803)	
17. Seat-Stem Seal	Group B (acc. item A.7.1.5.6)		Group C (acc. item A.7.1.5.6)		Group C (acc. item A.7.1.5.6)		Group E (acc. item A.7.1.5.6)	
18. Operator Type	2" - 3"	Lever	2" - 3"	Lever	2" - 3"	Lever	2" - 3"	Lever
	4" - 16"	Gearbox	4" - 16"	Gearbox	4" - 16"	Gearbox	4" - 16"	Gearbox
19. Additional Requirement	Fire Tested (acc. item A.6.1.4)		N/A		Fire Tested (acc. item A.6.1.4)		N/A	
20. Seat Type	Side A: SPE / Side B: DPE; DIB-2 & DBB		Side A: SPE / Side B: DPE; DIB-2 & DBB		Side A: SPE / Side B: DPE; DIB-2 & DBB		Side A: SPE / Side B: DPE; DIB-2 & DBB	
21. Bore Type	Full Bore		Full Bore		Full Bore		Full Bore	
22. Body Construction	split body, bolted		split body, bolted		split body, bolted		split body, bolted	
23. Cladding or Coating	N/A		N/A		N/A		N/A	
24. Valve Testing	FAT according A.9.3		FAT according A.9.3		FAT according A.9.3		FAT according A.9.3	
25. Notes	Acceptance criteria for sealing tests see Annex A		Acceptance criteria for sealing tests see Annex A		Acceptance criteria for sealing tests see Annex A		Acceptance criteria for sealing tests see Annex A	

Valve Code	VES-600-3-D273		VES-600-3-S218		VES-600-3-S219		VES-600-3-S228	
Specs	E16		E3		E3		E3	
1. Valve Type	Ball		Ball		Ball		Ball	
2. Sealing Type	Metal to Metal		Soft		Soft		Soft	
3. Valve Specification Level (VSL)	VSL-3		VSL-3		VSL-3		VSL-3	
4. Ball Mouting	Trunnion		Trunnion		Trunnion		Trunnion	
5. Standard	API 6D / IOGP S-562		API 6D / IOGP S-562		API 6D / IOGP S-562		API 6D / IOGP S-562	
6. Size Range (NPS)	2" - 16"		2" - 24"		2" - 24"		2" - 24"	
7. End Connection	ASME B16.5, RF		ASME B16.5, RF		ASME B16.5, RF		ASME B16.5, RF	
8. Pressure Class	600		600		600		600	
9. Temperature	-46°C to 150°C		-30°C to 150°C		-30°C to 150°C		0°C to 150°C	
10. Material Class	Duplex Steel		Stainless Steel		Stainless Steel		Stainless Steel	
11. Body Material	ASTM A182 Gr F51		ASTM A182 Gr F316		ASTM A182 Gr F316		ASTM A182 Gr F316	
12. Obturator Material	Duplex (UNS S31803) + Tungsten carbide coating		AISI 316		AISI 316		AISI 316	
13. Seat Material	Duplex (UNS S31803) + Tungsten carbide coating		AISI 316		AISI 316		AISI 316	
14. Seat Insert	N/A		PEEK		PEEK		PEEK	
15. Spring (Seat) Material	UNS N07750		UNS N07750		UNS N07750		UNS N07750	
16. Stem Material	ASTM A276 (UNS S31803)		ASTM A276 (UNS S31600)		ASTM A276 (UNS S31600)		ASTM A276 (UNS S31600)	
17. Seat-Stem Seal	Group E (acc. item A.7.1.5.6)		Group B (acc. item A.7.1.5.6)		Group B (acc. item A.7.1.5.6)		Group C (acc. item A.7.1.5.6)	
18. Operator Type	2" - 3"	Lever	2" - 3"	Lever	2" - 3"	Lever	2" - 3"	Lever
	4" - 16"	Gearbox	4" - 24"	Gearbox	4" - 24"	Gearbox	4" - 24"	Gearbox
19. Additional Requirement	Fire Tested (acc. item A.6.1.4)		N/A		Fire Tested (acc. item A.6.1.4)		N/A	
20. Seat Type	Side A: SPE / Side B: DPE; DIB-2 & DBB		Side A: SPE / Side B: DPE; DIB-2 & DBB		Side A: SPE / Side B: DPE; DIB-2 & DBB		Side A: SPE / Side B: DPE; DIB-2 & DBB	
21. Bore Type	Full Bore		Full Bore		Full Bore		Full Bore	
22. Body Construction	split body, bolted		split body, bolted		split body, bolted		split body, bolted	
23. Cladding or Coating	N/A		N/A		N/A		N/A	
24. Valve Testing	FAT according A.9.3		FAT according A.9.3		FAT according A.9.3		FAT according A.9.3	
25. Notes	Acceptance criteria for sealing tests see Annex A		N/A		N/A		N/A	

Valve Code	VES-600-3-S229		VES-600-3-S238		VES-600-3-S239		VES-600-3-S252	
Specs	E3		E3		E3		E3	
1. Valve Type	Ball		Ball		Ball		Ball	
2. Sealing Type	Soft		Soft		Soft		Metal to Metal	
3. Valve Specification Level (VSL)	VSL-3		VSL-3		VSL-3		VSL-3	
4. Ball Mouting	Trunnion		Trunnion		Trunnion		Trunnion	
5. Standard	API 6D / IOGP S-562		API 6D / IOGP S-562		API 6D / IOGP S-562		API 6D / IOGP S-562	
6. Size Range (NPS)	2" - 24"		2" - 24"		2" - 24"		2" - 24"	
7. End Connection	ASME B16.5, RF		ASME B16.5, RF		ASME B16.5, RF		ASME B16.5, RF	
8. Pressure Class	600		600		600		600	
9. Temperature	0°C to 150°C		-46°C to 150°C		-46°C to 150°C		-30°C to 150°C	
10. Material Class	Stainless Steel		Stainless Steel		Stainless Steel		Stainless Steel	
11. Body Material	ASTM A182 Gr F316		ASTM A182 Gr F316		ASTM A182 Gr F316		ASTM A182 Gr F316	
12. Obturator Material	AISI 316		AISI 316		AISI 316		AISI 316 + Tungsten carbide coating	
13. Seat Material	AISI 316		AISI 316		AISI 316		AISI 316 + Tungsten carbide coating	
14. Seat Insert	PEEK		PEEK		PEEK		N/A	
15. Spring (Seat) Material	UNS N07750		UNS N07750		UNS N07750		UNS N07750	
16. Stem Material	ASTM A276 (UNS S31600)		ASTM A276 (UNS S31600)		ASTM A276 (UNS S31600)		ASTM A276 (UNS S31600)	
17. Seat-Stem Seal	Group C (acc. item A.7.1.5.6)		Group E (acc. item A.7.1.5.6)		Group E (acc. item A.7.1.5.6)		Group B (acc. item A.7.1.5.6)	
18. Operator Type	2" - 3"	Lever	2" - 3"	Lever	2" - 3"	Lever	2" - 3"	Lever
	4" - 24"	Gearbox		4" - 24"		Gearbox		4" - 24"
19. Additional Requirement	Fire Tested (acc. item A.6.1.4)		N/A		Fire Tested (acc. item A.6.1.4)		N/A	
20. Seat Type	Side A: SPE / Side B: DPE; DIB-2 & DBB		Side A: SPE / Side B: DPE; DIB-2 & DBB		Side A: SPE / Side B: DPE; DIB-2 & DBB		Side A: SPE / Side B: DPE; DIB-2 & DBB	
21. Bore Type	Full Bore		Full Bore		Full Bore		Full Bore	
22. Body Construction	split body, bolted		split body, bolted		split body, bolted		split body, bolted	
23. Cladding or Coating	N/A		N/A		N/A		N/A	
24. Valve Testing	FAT according A.9.3		FAT according A.9.3		FAT according A.9.3		FAT according A.9.3	
25. Notes	N/A		N/A		N/A		Acceptance criteria for sealing tests see Annex A	

Valve Code	VES-600-3-S253		VES-600-3-S262		VES-600-3-S263		VES-600-3-S272	
Specs	E3		E3		E3		E3	
1. Valve Type	Ball		Ball		Ball		Ball	
2. Sealing Type	Metal to Metal		Metal to Metal		Metal to Metal		Metal to Metal	
3. Valve Specification Level (VSL)	VSL-3		VSL-3		VSL-3		VSL-3	
4. Ball Mouting	Trunnion		Trunnion		Trunnion		Trunnion	
5. Standard	API 6D / IOGP S-562		API 6D		API 6D		API 6D	
6. Size Range (NPS)	2" - 24"		2" - 24"		2" - 24"		2" - 24"	
7. End Connection	ASME B16.5, RF		ASME B16.5, RF		ASME B16.5, RF		ASME B16.5, RF	
8. Pressure Class	600		600		600		600	
9. Temperature	-30°C to 150°C		0°C to 210°C		0°C to 210°C		-100°C to 200°C	
10. Material Class	Stainless Steel		Stainless Steel		Stainless Steel		Stainless Steel	
11. Body Material	ASTM A182 Gr F316		ASTM A182 Gr F316		ASTM A182 Gr F316		ASTM A182 Gr F316	
12. Obturator Material	AISI 316 + Tungsten carbide coating		AISI 316 + Tungsten carbide coating		AISI 316 + Tungsten carbide coating		AISI 316 + Tungsten carbide coating	
13. Seat Material	AISI 316 + Tungsten carbide coating		AISI 316 + Tungsten carbide coating		AISI 316 + Tungsten carbide coating		AISI 316 + Tungsten carbide coating	
14. Seat Insert	N/A		N/A		N/A		N/A	
15. Spring (Seat) Material	UNS N07750		UNS N07750		UNS N07750		UNS N07750	
16. Stem Material	ASTM A276 (UNS S31600)		ASTM A276 (UNS S31600)		ASTM A276 (UNS S31600)		ASTM A276 (UNS S31600)	
17. Seat-Stem Seal	Group B (acc. item A.7.1.5.6)		Group C (acc. item A.7.1.5.6)		Group C (acc. item A.7.1.5.6)		Group E (acc. item A.7.1.5.6)	
18. Operator Type	2" - 3"	Lever	2" - 3"	Lever	2" - 3"	Lever	2" - 3"	Lever
	4" - 24"	Gearbox						
19. Additional Requirement	Fire Tested (acc. item A.6.1.4)		N/A		Fire Tested (acc. item A.6.1.4)		N/A	
20. Seat Type	Side A: SPE / Side B: DPE; DIB-2 & DBB		Side A: SPE / Side B: DPE; DIB-2 & DBB		Side A: SPE / Side B: DPE; DIB-2 & DBB		Side A: SPE / Side B: DPE; DIB-2 & DBB	
21. Bore Type	Full Bore		Full Bore		Full Bore		Full Bore	
22. Body Construction	split body, bolted		split body, bolted		split body, bolted		split body, bolted	
23. Cladding or Coating	N/A		N/A		N/A		N/A	
24. Valve Testing	FAT according A.9.3		FAT according A.9.3		FAT according A.9.3		FAT according A.9.3	
25. Notes	Acceptance criteria for sealing tests see Annex A		Acceptance criteria for sealing tests see Annex A		Acceptance criteria for sealing tests see Annex A		Acceptance criteria for sealing tests see Annex A	

Valve Code	VES-600-3-S273		VES-600-4-A574	VES-600-4-A584	VES-600-4-C154
Specs	E3		E32	E32	E9 E10
1. Valve Type	Ball		Ball	Ball	Ball
2. Sealing Type	Metal to Metal		Metal to Metal	Metal to Metal	Metal to Metal
3. Valve Specification Level (VSL)	VSL-3		VSL-4	VSL-4	VSL-4
4. Ball Mouting	Trunnion		Trunnion	Trunnion	Trunnion
5. Standard	API 6D		API 6D	API 6D	API 6D / IOGP S-562
6. Size Range (NPS)	2" - 24"		6" - 16"	6" - 16"	6" - 24"
7. End Connection	ASME B16.5, RF		ASME B16.5, RF	ASME B16.5, RF	ASME B16.5, RF
8. Pressure Class	600		600	600	600
9. Temperature	-100°C to 200°C		-100°C to 200°C	-100°C to 400°C	-29°C to 150°C
10. Material Class	Stainless Steel		Alloy Steel	Alloy Steel	Carbon Steel
11. Body Material	ASTM A182 Gr F316		ASTM A350 Gr LF3 + Inconel 625 weld overlay (acc. item A.7.1.7.3)	ASTM A350 Gr LF3 + Inconel 625 weld overlay (acc. item A.7.1.7.3)	ASTM A105 + SS316 weld overlay (acc. item A.7.1.7.3)
12. Obturator Material	AISI 316 + Tungsten carbide coating		ASTM A350 Gr LF3 + Inconel 625 weld overlay (acc. item A.7.1.7.3) + Tungsten carbide coating	ASTM A350 Gr LF3 + Inconel 625 weld overlay (acc. item A.7.1.7.3) + Chrome-Nickel Spray and Fuse (acc. Item A.8.2.2.4)	AISI 410 + Tungsten carbide coating
13. Seat Material	AISI 316 + Tungsten carbide coating		ASTM A350 Gr LF3 + Inconel 625 weld overlay (acc. item A.7.1.7.3) + Tungsten carbide coating	ASTM A350 Gr LF3 + Inconel 625 weld overlay (acc. item A.7.1.7.3) + Chrome-Nickel Spray and Fuse (acc. Item A.8.2.2.4)	AISI 410 + Tungsten carbide coating
14. Seat Insert	N/A		N/A	N/A	N/A
15. Spring (Seat) Material	UNS N07750		UNS N07750	UNS N07750	UNS N07750
16. Stem Material	ASTM A276 (UNS S31600)		ASTM B637 (UNS N07718)	ASTM B637 (UNS N07718)	ASTM A276 (UNS S41000)
17. Seat-Stem Seal	Group E (acc. item A.7.1.5.6)		Group E (acc. item A.7.1.5.6)	Group F (acc. item A.7.1.5.6)	Group B (acc. item A.7.1.5.6)
18. Operator Type	2" - 3"	Lever	Actuated	Actuated	Actuated
	4" - 24"	Gearbox	N/A	N/A	N/A
19. Additional Requirement	Fire Tested (acc. item A.6.1.4)		Fire Tested (acc. item A.6.1.4)	Fire Tested (acc. item A.6.1.4)	Fire Tested (acc. item A.6.1.4)
20. Seat Type	Side A: SPE / Side B: DPE; DIB-2 & DBB		Side A: SPE / Side B: DPE; DIB-2 & DBB (notes)	Side A: SPE / Side B: DPE; DIB-2 & DBB (notes)	Side A: SPE / Side B: DPE; DIB-2 & DBB (notes)
21. Bore Type	Full Bore		Full Bore	Full Bore	Full Bore
22. Body Construction	split body, bolted		split body, bolted	split body, bolted	split body, bolted
23. Cladding or Coating	N/A		Full clad - Inconel 625 weld overlay on all wetted parts	Full clad - Inconel 625 weld overlay on all wetted parts	Partial clad - SS316 weld overlay on all body sealing areas
24. Valve Testing	FAT according A.9.3		FAT according A.9.3	FAT according A.9.3	FAT according A.9.3
25. Notes	Acceptance criteria for sealing tests see Annex A		Acceptance criteria for sealing tests see Annex A, DBB tests to be performed at both conditions, fully opened and closed, Vent and drain connections according Annex A	Acceptance criteria for sealing tests see Annex A, DBB tests to be performed at both conditions, fully opened and closed, Vent and drain connections according Annex A	Acceptance criteria for sealing tests see Annex A, DBB tests to be performed at both conditions, fully opened and closed, Vent and drain connections according Annex A

Valve Code	VES-600-4-C164	VES-600-4-C174	VES-600-4-C254	VES-600-4-C274
Specs	E9 E10	E9 E10	E6 E19	E6 E19
1. Valve Type	Ball	Ball	Ball	Ball
2. Sealing Type	Metal to Metal	Metal to Metal	Metal to Metal	Metal to Metal
3. Valve Specification Level (VSL)	VSL-4	VSL-4	VSL-4	VSL-4
4. Ball Mouting	Trunnion	Trunnion	Trunnion	Trunnion
5. Standard	API 6D	API 6D	API 6D / IOGP S-562	API 6D
6. Size Range (NPS)	2" - 24"	6" - 24"	6" - 24"	6" - 24"
7. End Connection	ASME B16.5, RF	ASME B16.5, RF	ASME B16.5, RF	ASME B16.5, RF
8. Pressure Class	600	600	600	600
9. Temperature	0°C to 210°C	-29°C to 200°C	-30°C to 150°C	-46°C to 200°C
10. Material Class	Carbon Steel	Carbon Steel	Carbon Steel	Carbon Steel
11. Body Material	ASTM A105 + SS316 weld overlay (acc. item A.7.1.7.3)	ASTM A105 + SS316 weld overlay (acc. item A.7.1.7.3)	ASTM A350 Gr LF2 CL1 + Inconel 625 weld overlay (acc. item A.7.1.7.3)	ASTM A350 Gr LF2 CL1 + Inconel 625 weld overlay (acc. item A.7.1.7.3)
12. Obturator Material	AISI 410 + Tungsten carbide coating	AISI 410 + Tungsten carbide coating	AISI 316 + Tungsten carbide coating	AISI 316 + Tungsten carbide coating
13. Seat Material	AISI 410 + Tungsten carbide coating	AISI 410 + Tungsten carbide coating	AISI 316 + Tungsten carbide coating	AISI 316 + Tungsten carbide coating
14. Seat Insert	N/A	N/A	N/A	N/A
15. Spring (Seat) Material	UNS N07750	UNS N07750	UNS N07750	UNS N07750
16. Stem Material	ASTM A276 (UNS S41000)	ASTM A276 (UNS S41000)	ASTM A276 (UNS S31600)	ASTM A276 (UNS S31600)
17. Seat-Stem Seal	Group C (acc. item A.7.1.5.6)	Group E (acc. item A.7.1.5.6)	Group B (acc. item A.7.1.5.6)	Group E (acc. item A.7.1.5.6)
18. Operator Type	Actuated	Actuated	Actuated	Actuated
19. Additional Requirement	Fire Tested (acc. item A.6.1.4)	Fire Tested (acc. item A.6.1.4)	Fire Tested (acc. item A.6.1.4)	Fire Tested (acc. item A.6.1.4)
20. Seat Type	Side A: SPE / Side B: DPE; DIB-2 & DBB (notes)	Side A: SPE / Side B: DPE; DIB-2 & DBB (notes)	Side A: SPE / Side B: DPE; DIB-2 & DBB (notes)	Side A: SPE / Side B: DPE; DIB-2 & DBB (notes)
21. Bore Type	Full Bore	Full Bore	Full Bore	Full Bore
22. Body Construction	split body, bolted	split body, bolted	split body, bolted	split body, bolted
23. Cladding or Coating	Partial clad - SS316 weld overlay on all body sealing areas	Partial clad - SS316 weld overlay on all body sealing areas	Partial clad - Inconel 625 weld overlay on all body sealing areas	Partial clad - Inconel 625 weld overlay on all body sealing areas
24. Valve Testing	FAT according A.9.3	FAT according A.9.3	FAT according A.9.3	FAT according A.9.3
25. Notes	Acceptance criteria for sealing tests see Annex A, DBB tests to be performed at both conditions, fully opened and closed, Vent and drain connections according Annex A	Acceptance criteria for sealing tests see Annex A, DBB tests to be performed at both conditions, fully opened and closed, Vent and drain connections according Annex A	Acceptance criteria for sealing tests see Annex A, DBB tests to be performed at both conditions, fully opened and closed, Vent and drain connections according Annex A	Acceptance criteria for sealing tests see Annex A, DBB tests to be performed at both conditions, fully opened and closed, Vent and drain connections according Annex A

Valve Code	VES-600-4-C564	VES-600-4-C574	VES-600-4-C584	VES-800-1-C103
Specs	E30	E30	E30	C8 E8
1. Valve Type	Ball	Ball	Ball	Ball
2. Sealing Type	Metal to Metal	Metal to Metal	Metal to Metal	Soft
3. Valve Specification Level (VSL)	VSL-4	VSL-4	VSL-4	VSL-1
4. Ball Mouting	Trunnion	Trunnion	Trunnion	N/A
5. Standard	API 6D	API 6D	API 6D	ISO 17292
6. Size Range (NPS)	4" - 20"	6" - 20"	6" - 20"	½" - 1 ½"
7. End Connection	ASME B16.5, RF	ASME B16.5, RF	ASME B16.5, RF	N/A
8. Pressure Class	600	600	600	800
9. Temperature	0°C to 210°C	0°C to 210°C	0°C to 400°C	-29°C to 120°C
10. Material Class	Carbon Steel	Carbon Steel	Carbon Steel	Carbon Steel
11. Body Material	ASTM A105 + Inconel 625 weld overlay (acc. item A.7.1.7.3)	ASTM A105 + Inconel 625 weld overlay (acc. item A.7.1.7.3)	ASTM A105 + Inconel 625 weld overlay (acc. item A.7.1.7.3)	ASTM A105
12. Obturator Material	ASTM A105 + Inconel 625 weld overlay (acc. item A.7.1.7.3) + Tungsten carbide coating	ASTM A105 + Inconel 625 weld overlay (acc. item A.7.1.7.3) + Tungsten carbide coating	ASTM A105 + Inconel 625 weld overlay (acc. item A.7.1.7.3) + Chrome-Nickel Spray and Fuse (acc. Item A.8.2.2.4)	AISI 410
13. Seat Material	ASTM A105 + Inconel 625 weld overlay (acc. item A.7.1.7.3) + Tungsten carbide coating	ASTM A105 + Inconel 625 weld overlay (acc. item A.7.1.7.3) + Tungsten carbide coating	ASTM A105 + Inconel 625 weld overlay (acc. item A.7.1.7.3) + Chrome-Nickel Spray and Fuse (acc. Item A.8.2.2.4)	Devlon V-API
14. Seat Insert	N/A	N/A	N/A	N/A
15. Spring (Seat) Material	UNS N07750	UNS N07750	UNS N07750	N/A
16. Stem Material	ASTM B637 (UNS N07718)	ASTM B637 (UNS N07718)	ASTM B637 (UNS N07718)	ASTM A276 (UNS S31803)
17. Seat-Stem Seal	Group C (acc. item A.7.1.5.6)	Group D (acc. item A.7.1.5.6)	Group F (acc. item A.7.1.5.6)	Group B (acc. item A.7.1.5.6)
18. Operator Type	Actuated	Actuated	Actuated	N/A
19. Additional Requirement	Fire Tested (acc. item A.6.1.4)	Fire Tested (acc. item A.6.1.4)	Fire Tested (acc. item A.6.1.4)	Fire Tested (acc. item A.6.1.4)
20. Seat Type	Side A: SPE / Side B: DPE; DIB-2 & DBB (notes)	Side A: SPE / Side B: DPE; DIB-2 & DBB (notes)	Side A: SPE / Side B: DPE; DIB-2 & DBB (notes)	N/A
21. Bore Type	Full Bore	Full Bore	Full Bore	Full Bore
22. Body Construction	split body, bolted	split body, bolted	split body, bolted	split body, bolted
23. Cladding or Coating	Full clad - Inconel 625 weld overlay on all wetted parts	Full clad - Inconel 625 weld overlay on all wetted parts	Full clad - Inconel 625 weld overlay on all wetted parts	N/A
24. Valve Testing	FAT according A.9.3	FAT according A.9.3	FAT according A.9.3	FAT according A.9.3
25. Notes	Acceptance criteria for sealing tests see Annex A, DBB tests to be performed at both conditions, fully opened and closed, Vent and drain connections according Annex A	Acceptance criteria for sealing tests see Annex A, DBB tests to be performed at both conditions, fully opened and closed, Vent and drain connections according Annex A	Acceptance criteria for sealing tests see Annex A, DBB tests to be performed at both conditions, fully opened and closed, Vent and drain connections according Annex A	N/A

Valve Code	VES-800-2-C103	VES-801-1-D201	VES-801-1-D202	VES-801-1-D203
Specs	C8 E8	B16 C16 E16	B16 C16 E16	E16
1. Valve Type	Ball	Ball	Ball	Ball
2. Sealing Type	Soft	Soft	Soft	Soft
3. Valve Specification Level (VSL)	VSL-2	VSL-1	VSL-1	VSL-1
4. Ball Mouting	Floating	Floating	Floating	Floating
5. Standard	ISO 17292	ISO 17292	ISO 17292	ISO 17292
6. Size Range (NPS)	½" - 1 ½"	½" - 1 ½"	½" - 1 ½"	½" - 1 ½"
7. End Connection	Screwed ends ASME B1.20.1 NPT	socket weld ends ASME B16.11 with nipple SCH 40S	socket weld ends ASME B16.11 with nipple SCH 40S	socket weld ends ASME B16.11 with nipple SCH 40S
8. Pressure Class	800	800	800	800
9. Temperature	-29°C to 120°C	-30°C to 150°C	-46°C to 150°C	-30°C to 120°C
10. Material Class	Carbon Steel	Duplex Steel	Duplex Steel	Duplex Steel
11. Body Material	ASTM A105	ASTM A182 Gr F51	ASTM A182 Gr F51	ASTM A182 Gr F51
12. Obturator Material	AISI 410	Duplex (UNS S31803)	Duplex (UNS S31803)	Duplex (UNS S31803)
13. Seat Material	Devlon V-API	PTFE reinforced with 25% Carbon	PTFE reinforced with 25% Carbon	Devlon V-API
14. Seat Insert	N/A	N/A	N/A	N/A
15. Spring (Seat) Material	N/A	N/A	N/A	N/A
16. Stem Material	ASTM A276 (UNS S41000)	ASTM A276 (UNS S31803)	ASTM A276 (UNS S31803)	ASTM A276 (UNS S31803)
17. Seat-Stem Seal	Group B (acc. item A.7.1.5.6)	Group B (acc. item A.7.1.5.6)	Group E (acc. item A.7.1.5.6)	Group B (acc. item A.7.1.5.6)
18. Operator Type	Lever	Lever	Lever	Lever
19. Additional Requirement	Fire Tested (acc. item A.6.1.4)	Fire Tested (acc. item A.6.1.4)	Fire Tested (acc. item A.6.1.4)	Fire Tested (acc. item A.6.1.4)
20. Seat Type	N/A	N/A	N/A	N/A
21. Bore Type	Full Bore	Full Bore	Full Bore	Full Bore
22. Body Construction	split body, bolted	split body, bolted	split body, bolted	split body, bolted
23. Cladding or Coating	N/A	N/A	N/A	N/A
24. Valve Testing	FAT according A.9.3	FAT according A.9.3	FAT according A.9.3	FAT according A.9.3
25. Notes	N/A	N/A	N/A	N/A

Valve Code	VES-801-1-D204	VES-801-1-D205	VES-801-1-D301	VES-801-1-D305
Specs	E16	B16 C16 E16	B12 C12	B12 C12
1. Valve Type	Ball	Ball	Ball	Ball
2. Sealing Type	Soft	Metal to Metal	Soft	Metal to Metal
3. Valve Specification Level (VSL)	VSL-1	VSL-1	VSL-1	VSL-1
4. Ball Mouting	Floating	Floating	Floating	Floating
5. Standard	ISO 17292	ISO 17292	ISO 17292	ISO 17292
6. Size Range (NPS)	½" - 1 ½"	½" - 1 ½"	½" - 1 ½"	½" - 1 ½"
7. End Connection	socket weld ends ASME B16.11 with nipple SCH 40S	socket weld ends ASME B16.11 with nipple SCH 40S	socket weld ends ASME B16.11 with nipple SCH 40S	socket weld ends ASME B16.11 with nipple SCH 40S
8. Pressure Class	800	800	800	800
9. Temperature	-46°C to 150°C	-46°C to 150°C	0°C to 150°C	0°C to 150°C
10. Material Class	Duplex Steel	Duplex Steel	Duplex Steel	Duplex Steel
11. Body Material	ASTM A182 Gr F51	ASTM A182 Gr F51	ASTM A182 Gr F55	ASTM A182 Gr F55
12. Obturator Material	Duplex (UNS S31803)	Duplex (UNS S31803) + Hard Coating (acc. Item A.7.1.7.4)	Super Duplex (UNS S32760)	Super Duplex (UNS S32760) + Hard Coating (acc. Item A.7.1.7.4)
13. Seat Material	PEEK	Duplex (UNS S31803) + Hard Coating (acc. Item A.7.1.7.4)	PTFE reinforced with 25% Carbon	Super Duplex (UNS S32760) + Hard Coating (acc. Item A.7.1.7.4)
14. Seat Insert	N/A	N/A	N/A	N/A
15. Spring (Seat) Material	N/A	N/A	N/A	N/A
16. Stem Material	ASTM A276 (UNS S31803)	ASTM A276 (UNS S31803)	ASTM A276 (UNS S32760)	ASTM A276 (UNS S32760)
17. Seat-Stem Seal	Group E (acc. item A.7.1.5.6)	Group E (acc. item A.7.1.5.6)	Group A (acc. item A.7.1.5.6)	Group D (acc. item A.7.1.5.6)
18. Operator Type	Lever	Lever	Lever	Lever
19. Additional Requirement	Fire Tested (acc. item A.6.1.4)	Fire Tested (acc. item A.6.1.4)	Fire Tested (acc. item A.6.1.4)	Fire Tested (acc. item A.6.1.4)
20. Seat Type	N/A	N/A	N/A	N/A
21. Bore Type	Full Bore	Full Bore	Full Bore	Full Bore
22. Body Construction	split body, bolted	split body, bolted	split body, bolted	split body, bolted
23. Cladding or Coating	N/A	N/A	N/A	N/A
24. Valve Testing	FAT according A.9.3	FAT according A.9.3	FAT according A.9.3	FAT according A.9.3
25. Notes	N/A	N/A	N/A	N/A

Valve Code	VES-801-1-N101	VES-801-1-N102	VES-801-1-N104	VES-801-1-N105
Specs	B30 C30	B30 C30	E30 E32	B30 C30 E30 E32
1. Valve Type	Ball	Ball	Ball	Ball
2. Sealing Type	Soft	Soft	Soft	Metal to Metal
3. Valve Specification Level (VSL)	VSL-1	VSL-1	VSL-1	VSL-1
4. Ball Mouting	Floating	Floating	Floating	Floating
5. Standard	ISO 17292	ISO 17292	ISO 17292	ISO 17292
6. Size Range (NPS)	½" - 1 ½"	½" - 1 ½"	½" - 1 ½"	½" - 1 ½"
7. End Connection	socket weld ends ASME B16.11 with nipple SCH 40S	socket weld ends ASME B16.11 with nipple SCH 40S	socket weld ends ASME B16.11 with nipple SCH 40S	socket weld ends ASME B16.11 with nipple SCH 40S
8. Pressure Class	800	800	800	800
9. Temperature	-30°C to 150°C	-46°C to 150°C	-46°C to 150°C	-100°C to 200°C
10. Material Class	Nickel Alloys	Nickel Alloys	Nickel Alloys	Nickel Alloys
11. Body Material	ASTM B564 (UNS N06625)	ASTM B564 (UNS N06625)	ASTM B564 (UNS N06625)	ASTM B564 (UNS N06625)
12. Obturator Material	ASTM B564 (UNS N06625)	ASTM B564 (UNS N06625)	ASTM B564 (UNS N06625)	ASTM B564 (UNS N06625) + Hard Coating (acc. Item A.7.1.7.4)
13. Seat Material	PTFE reinforced with 25% Carbon	PTFE reinforced with 25% Carbon	PEEK	ASTM B564 (UNS N06625) + Hard Coating (acc. Item A.7.1.7.4)
14. Seat Insert	N/A	N/A	N/A	N/A
15. Spring (Seat) Material	N/A	N/A	N/A	N/A
16. Stem Material	ASTM B637 (UNS N07718)	ASTM B637 (UNS N07718)	ASTM B637 (UNS N07718)	ASTM B637 (UNS N07718)
17. Seat-Stem Seal	Group B (acc. item A.7.1.5.6)	Group E (acc. item A.7.1.5.6)	Group E (acc. item A.7.1.5.6)	Group E (acc. item A.7.1.5.6)
18. Operator Type	Lever	Lever	Lever	Lever
19. Additional Requirement	Fire Tested (acc. item A.6.1.4)	Fire Tested (acc. item A.6.1.4)	Fire Tested (acc. item A.6.1.4)	Fire Tested (acc. item A.6.1.4)
20. Seat Type	N/A	N/A	N/A	N/A
21. Bore Type	Full Bore	Full Bore	Full Bore	Full Bore
22. Body Construction	split body, bolted	split body, bolted	split body, bolted	split body, bolted
23. Cladding or Coating	N/A	N/A	N/A	N/A
24. Valve Testing	FAT according A.9.3	FAT according A.9.3	FAT according A.9.3	FAT according A.9.3
25. Notes	N/A	N/A	N/A	N/A

Valve Code	VES-801-1-S201	VES-801-1-S202	VES-801-1-S203	VES-801-1-S204
Specs	B3 C3 R3B R3C S3B S3C	B3 C3	E3	E3
1. Valve Type	Ball	Ball	Ball	Ball
2. Sealing Type	Soft	Soft	Soft	Soft
3. Valve Specification Level (VSL)	VSL-1	VSL-1	VSL-1	VSL-1
4. Ball Mouting	Floating	Floating	Floating	Floating
5. Standard	ISO 17292	ISO 17292	ISO 17292	ISO 17292
6. Size Range (NPS)	½" - 1 ½"	½" - 1 ½"	½" - 1 ½"	½" - 1 ½"
7. End Connection	socket weld ends ASME B16.11 with nipple SCH 40S	socket weld ends ASME B16.11 with nipple SCH 40S	socket weld ends ASME B16.11 with nipple SCH 40S	socket weld ends ASME B16.11 with nipple SCH 40S
8. Pressure Class	800	800	800	800
9. Temperature	-30°C to 150°C	-46°C to 150°C	-30°C to 120°C	-30°C to 150°C
10. Material Class	Stainless Steel	Stainless Steel	Stainless Steel	Stainless Steel
11. Body Material	ASTM A182 Gr F316/316L	ASTM A182 Gr F316/316L	ASTM A182 Gr F316/316L	ASTM A182 Gr F316/316L
12. Obturator Material	AISI 316	AISI 316	AISI 316	AISI 316
13. Seat Material	PTFE reinforced with 25% Carbon	PTFE reinforced with 25% Carbon	Devlon V-API	PEEK
14. Seat Insert	N/A	N/A	N/A	N/A
15. Spring (Seat) Material	N/A	N/A	N/A	N/A
16. Stem Material	ASTM A276 (UNS S31600)	ASTM A276 (UNS S31600)	ASTM A276 (UNS S31600)	ASTM A276 (UNS S31600)
17. Seat-Stem Seal	Group B (acc. item A.7.1.5.6)	Group E (acc. item A.7.1.5.6)	Group B (acc. item A.7.1.5.6)	Group E (acc. item A.7.1.5.6)
18. Operator Type	Lever	Lever	Lever	Lever
19. Additional Requirement	Fire Tested (acc. item A.6.1.4)	Fire Tested (acc. item A.6.1.4)	Fire Tested (acc. item A.6.1.4)	Fire Tested (acc. item A.6.1.4)
20. Seat Type	N/A	N/A	N/A	N/A
21. Bore Type	Full Bore	Full Bore	Full Bore	Full Bore
22. Body Construction	split body, bolted	split body, bolted	split body, bolted	split body, bolted
23. Cladding or Coating	N/A	N/A	N/A	N/A
24. Valve Testing	FAT according A.9.3	FAT according A.9.3	FAT according A.9.3	FAT according A.9.3
25. Notes	N/A	N/A	N/A	N/A

Valve Code	VES-801-1-S205	VES-801-2-D201	VES-801-2-D202	VES-801-2-D203
Specs	B3 C3 E3	B16 C16 E16	B16 C16 E16	E16
1. Valve Type	Ball	Ball	Ball	Ball
2. Sealing Type	Metal to Metal	Soft	Soft	Soft
3. Valve Specification Level (VSL)	VSL-1	VSL-2	VSL-2	VSL-2
4. Ball Mouting	Floating	Floating	Floating	Floating
5. Standard	ISO 17292	ISO 17292	ISO 17292	ISO 17292
6. Size Range (NPS)	½" - 1 ½"	½" - 1 ½"	½" - 1 ½"	½" - 1 ½"
7. End Connection	socket weld ends ASME B16.11 with nipple SCH 40S	socket weld ends ASME B16.11 with nipple SCH 40S	socket weld ends ASME B16.11 with nipple SCH 40S	socket weld ends ASME B16.11 with nipple SCH 40S
8. Pressure Class	800	800	800	800
9. Temperature	-100°C to 200°C	-30°C to 150°C	-46°C to 150°C	-30°C to 120°C
10. Material Class	Stainless Steel	Duplex Steel	Duplex Steel	Duplex Steel
11. Body Material	ASTM A182 Gr F316/316L	ASTM A182 Gr F51	ASTM A182 Gr F51	ASTM A182 Gr F51
12. Obturator Material	AISI 316 + Hard Coating (acc. Item A.7.1.7.4)	Duplex (UNS S31803)	Duplex (UNS S31803)	Duplex (UNS S31803)
13. Seat Material	AISI 316 + Hard Coating (acc. Item A.7.1.7.4)	PTFE reinforced with 25% Carbon	PTFE reinforced with 25% Carbon	Devlon V-API
14. Seat Insert	N/A	N/A	N/A	N/A
15. Spring (Seat) Material	N/A	N/A	N/A	N/A
16. Stem Material	ASTM A276 (UNS S31600)	ASTM A276 (UNS S31803)	ASTM A276 (UNS S31803)	ASTM A276 (UNS S31803)
17. Seat-Stem Seal	Group E (acc. item A.7.1.5.6)	Group B (acc. item A.7.1.5.6)	Group E (acc. item A.7.1.5.6)	Group B (acc. item A.7.1.5.6)
18. Operator Type	Lever	Lever	Lever	Lever
19. Additional Requirement	Fire Tested (acc. item A.6.1.4)	Fire Tested (acc. item A.6.1.4)	Fire Tested (acc. item A.6.1.4)	Fire Tested (acc. item A.6.1.4)
20. Seat Type	N/A	N/A	N/A	N/A
21. Bore Type	Full Bore	Full Bore	Full Bore	Full Bore
22. Body Construction	split body, bolted	split body, bolted	split body, bolted	split body, bolted
23. Cladding or Coating	N/A	N/A	N/A	N/A
24. Valve Testing	FAT according A.9.3	FAT according A.9.3	FAT according A.9.3	FAT according A.9.3
25. Notes	N/A	N/A	N/A	N/A

Valve Code	VES-801-2-D204	VES-801-2-D205	VES-801-2-D301	VES-801-2-D305
Specs	E16	B16 C16 E16	B12 C12	B12 C12
1. Valve Type	Ball	Ball	Ball	Ball
2. Sealing Type	Soft	Metal to Metal	Soft	Metal to Metal
3. Valve Specification Level (VSL)	VSL-2	VSL-2	VSL-2	VSL-2
4. Ball Mouting	Floating	Floating	Floating	Floating
5. Standard	ISO 17292	ISO 17292	ISO 17292	ISO 17292
6. Size Range (NPS)	½" - 1 ½"	½" - 1 ½"	½" - 1 ½"	½" - 1 ½"
7. End Connection	socket weld ends ASME B16.11 with nipple SCH 40S	socket weld ends ASME B16.11 with nipple SCH 40S	socket weld ends ASME B16.11 with nipple SCH 40S	socket weld ends ASME B16.11 with nipple SCH 40S
8. Pressure Class	800	800	800	800
9. Temperature	-46°C to 150°C	-46°C to 150°C	0°C to 150°C	0°C to 150°C
10. Material Class	Duplex Steel	Duplex Steel	Duplex Steel	Duplex Steel
11. Body Material	ASTM A182 Gr F51	ASTM A182 Gr F51	ASTM A182 Gr F55	ASTM A182 Gr F55
12. Obturator Material	Duplex (UNS S31803)	Duplex (UNS S31803) + Hard Coating (acc. Item A.7.1.7.4)	Super Duplex (UNS S32760)	Super Duplex (UNS S32760) + Hard Coating (acc. Item A.7.1.7.4)
13. Seat Material	PEEK	Duplex (UNS S31803) + Hard Coating (acc. Item A.7.1.7.4)	PTFE reinforced with 25% Carbon	Super Duplex (UNS S32760) + Hard Coating (acc. Item A.7.1.7.4)
14. Seat Insert	N/A	N/A	N/A	N/A
15. Spring (Seat) Material	N/A	N/A	N/A	N/A
16. Stem Material	ASTM A276 (UNS S31803)	ASTM A276 (UNS S31803)	ASTM A276 (UNS S32760)	ASTM A276 (UNS S32760)
17. Seat-Stem Seal	Group E (acc. item A.7.1.5.6)	Group E (acc. item A.7.1.5.6)	Group A (acc. item A.7.1.5.6)	Group D (acc. item A.7.1.5.6)
18. Operator Type	Lever	Lever	Lever	Lever
19. Additional Requirement	Fire Tested (acc. item A.6.1.4)	Fire Tested (acc. item A.6.1.4)	Fire Tested (acc. item A.6.1.4)	Fire Tested (acc. item A.6.1.4)
20. Seat Type	N/A	N/A	N/A	N/A
21. Bore Type	Full Bore	Full Bore	Full Bore	Full Bore
22. Body Construction	split body, bolted	split body, bolted	split body, bolted	split body, bolted
23. Cladding or Coating	N/A	N/A	N/A	N/A
24. Valve Testing	FAT according A.9.3	FAT according A.9.3	FAT according A.9.3	FAT according A.9.3
25. Notes	N/A	N/A	N/A	N/A

Valve Code	VES-801-2-N101	VES-801-2-N102	VES-801-2-N104	VES-801-2-N105
Specs	B30 C30 E30 E32	B30 C30	E30 E32	B30 C30 E30 E32
1. Valve Type	Ball	Ball	Ball	Ball
2. Sealing Type	Soft	Soft	Soft	Metal to Metal
3. Valve Specification Level (VSL)	VSL-2	VSL-2	VSL-2	VSL-2
4. Ball Mouting	Floating	Floating	Floating	Floating
5. Standard	ISO 17292	ISO 17292	ISO 17292	ISO 17292
6. Size Range (NPS)	½" - 1 ½"	½" - 1 ½"	½" - 1 ½"	½" - 1 ½"
7. End Connection	socket weld ends ASME B16.11 with nipple SCH 40S	socket weld ends ASME B16.11 with nipple SCH 40S	socket weld ends ASME B16.11 with nipple SCH 40S	socket weld ends ASME B16.11 with nipple SCH 40S
8. Pressure Class	800	800	800	800
9. Temperature	-30°C to 150°C	-46°C to 150°C	-46°C to 150°C	-100°C to 200°C
10. Material Class	Nickel Alloys	Nickel Alloys	Nickel Alloys	Nickel Alloys
11. Body Material	ASTM B564 (UNS N06625)	ASTM B564 (UNS N06625)	ASTM B564 (UNS N06625)	ASTM B564 (UNS N06625)
12. Obturator Material	ASTM B564 (UNS N06625)	ASTM B564 (UNS N06625)	ASTM B564 (UNS N06625)	ASTM B564 (UNS N06625) + Hard Coating (acc. Item A.7.1.7.4)
13. Seat Material	PTFE reinforced with 25% Carbon	PTFE reinforced with 25% Carbon	PEEK	ASTM B564 (UNS N06625) + Hard Coating (acc. Item A.7.1.7.4)
14. Seat Insert	N/A	N/A	N/A	N/A
15. Spring (Seat) Material	N/A	N/A	N/A	N/A
16. Stem Material	ASTM B637 (UNS N07718)	ASTM B637 (UNS N07718)	ASTM B637 (UNS N07718)	ASTM B637 (UNS N07718)
17. Seat-Stem Seal	Group B (acc. item A.7.1.5.6)	Group E (acc. item A.7.1.5.6)	Group E (acc. item A.7.1.5.6)	Group E (acc. item A.7.1.5.6)
18. Operator Type	Lever	Lever	Lever	Lever
19. Additional Requirement	Fire Tested (acc. item A.6.1.4)	Fire Tested (acc. item A.6.1.4)	Fire Tested (acc. item A.6.1.4)	Fire Tested (acc. item A.6.1.4)
20. Seat Type	N/A	N/A	N/A	N/A
21. Bore Type	Full Bore	Full Bore	Full Bore	Full Bore
22. Body Construction	split body, bolted	split body, bolted	split body, bolted	split body, bolted
23. Cladding or Coating	N/A	N/A	N/A	N/A
24. Valve Testing	FAT according A.9.3	FAT according A.9.3	FAT according A.9.3	FAT according A.9.3
25. Notes	N/A	N/A	N/A	N/A

Valve Code	VES-801-2-N106	VES-801-2-S201	VES-801-2-S202	VES-801-2-S203
Specs	E32	B3 C3 E3	B3 C3 E3	E3
1. Valve Type	Ball	Ball	Ball	Ball
2. Sealing Type	Metal to Metal	Soft	Soft	Soft
3. Valve Specification Level (VSL)	VSL-2	VSL-2	VSL-2	VSL-2
4. Ball Mouting	Floating	Floating	Floating	Floating
5. Standard	ISO 17292	ISO 17292	ISO 17292	ISO 17292
6. Size Range (NPS)	½" - 1 ½"	½" - 1 ½"	½" - 1 ½"	½" - 1 ½"
7. End Connection	socket weld ends ASME B16.11 with nipple SCH 40S	socket weld ends ASME B16.11 with nipple SCH 40S	socket weld ends ASME B16.11 with nipple SCH 40S	socket weld ends ASME B16.11 with nipple SCH 40S
8. Pressure Class	800	800	800	800
9. Temperature	-100°C to 340°C	-30°C to 150°C	-46°C to 150°C	-30°C to 120°C
10. Material Class	Nickel Alloys	Stainless Steel	Stainless Steel	Stainless Steel
11. Body Material	ASTM B564 (UNS N06625)	ASTM A182 Gr F316/316L	ASTM A182 Gr F316/316L	ASTM A182 Gr F316/316L
12. Obturator Material	ASTM B564 (UNS N06625) + Hard Coating (acc. Item A.7.1.7.4)	AISI 316	AISI 316	AISI 316
13. Seat Material	ASTM B564 (UNS N06625) + Hard Coating (acc. Item A.7.1.7.4)	PTFE reinforced with 25% Carbon	PTFE reinforced with 25% Carbon	Devlon V-API
14. Seat Insert	N/A	N/A	N/A	N/A
15. Spring (Seat) Material	N/A	N/A	N/A	N/A
16. Stem Material	ASTM B637 (UNS N07718)	ASTM A276 (UNS S31600)	ASTM A276 (UNS S31600)	ASTM A276 (UNS S31600)
17. Seat-Stem Seal	Group F (acc. item A.7.1.5.6)	Group B (acc. item A.7.1.5.6)	Group E (acc. item A.7.1.5.6)	Group B (acc. item A.7.1.5.6)
18. Operator Type	Lever	Lever	Lever	Lever
19. Additional Requirement	Fire Tested (acc. item A.6.1.4)	Fire Tested (acc. item A.6.1.4)	Fire Tested (acc. item A.6.1.4)	Fire Tested (acc. item A.6.1.4)
20. Seat Type	N/A	N/A	N/A	N/A
21. Bore Type	Full Bore	Full Bore	Full Bore	Full Bore
22. Body Construction	split body, bolted	split body, bolted	split body, bolted	split body, bolted
23. Cladding or Coating	N/A	N/A	N/A	N/A
24. Valve Testing	FAT according A.9.3	FAT according A.9.3	FAT according A.9.3	FAT according A.9.3
25. Notes	N/A	N/A	N/A	N/A

Valve Code	VES-801-2-S204	VES-801-2-S205	VES-801-3-D205	VES-801-3-D305
Specs	E3	B3 C3 E3	B16 C16 E16	B12 C12
1. Valve Type	Ball	Ball	Ball	Ball
2. Sealing Type	Soft	Metal to Metal	Metal to Metal	Metal to Metal
3. Valve Specification Level (VSL)	VSL-2	VSL-2	VSL-3	VSL-3
4. Ball Mouting	Floating	Floating	Floating	Floating
5. Standard	ISO 17292	ISO 17292	ISO 17292	ISO 17292
6. Size Range (NPS)	½" - 1 ½"	½" - 1 ½"	½" - 1 ½"	½" - 1 ½"
7. End Connection	socket weld ends ASME B16.11 with nipple SCH 40S	socket weld ends ASME B16.11 with nipple SCH 40S	socket weld ends ASME B16.11 with nipple SCH 40S	socket weld ends ASME B16.11 with nipple SCH 40S
8. Pressure Class	800	800	800	800
9. Temperature	-30°C to 150°C	-100°C to 200°C	-46°C to 150°C	0°C to 150°C
10. Material Class	Stainless Steel	Stainless Steel	Duplex Steel	Duplex Steel
11. Body Material	ASTM A182 Gr F316/316L	ASTM A182 Gr F316/316L	ASTM A182 Gr F51	ASTM A182 Gr F55
12. Obturator Material	AISI 316	AISI 316 + Hard Coating (acc. Item A.7.1.7.4)	Duplex (UNS S31803) + Hard Coating (acc. Item A.7.1.7.4)	Super Duplex (UNS S32760) + Hard Coating (acc. Item A.7.1.7.4)
13. Seat Material	PEEK	AISI 316 + Hard Coating (acc. Item A.7.1.7.4)	Duplex (UNS S31803) + Hard Coating (acc. Item A.7.1.7.4)	Super Duplex (UNS S32760) + Hard Coating (acc. Item A.7.1.7.4)
14. Seat Insert	N/A	N/A	N/A	N/A
15. Spring (Seat) Material	N/A	N/A	N/A	N/A
16. Stem Material	ASTM A276 (UNS S31600)	ASTM A276 (UNS S31600)	ASTM A276 (UNS S31803)	ASTM A276 (UNS S32760)
17. Seat-Stem Seal	Group E (acc. item A.7.1.5.6)	Group E (acc. item A.7.1.5.6)	Group E (acc. item A.7.1.5.6)	Group D (acc. item A.7.1.5.6)
18. Operator Type	Lever	Lever	Lever	Lever
19. Additional Requirement	Fire Tested (acc. item A.6.1.4)	Fire Tested (acc. item A.6.1.4)	Fire Tested (acc. item A.6.1.4)	Fire Tested (acc. item A.6.1.4)
20. Seat Type	N/A	N/A	N/A	N/A
21. Bore Type	Full Bore	Full Bore	Full Bore	Full Bore
22. Body Construction	split body, bolted	split body, bolted	split body, bolted	split body, bolted
23. Cladding or Coating	N/A	N/A	N/A	N/A
24. Valve Testing	FAT according A.9.3	FAT according A.9.3	FAT according A.9.3	FAT according A.9.3
25. Notes	N/A	N/A	N/A	N/A

Valve Code	VES-801-3-N105	VES-801-3-S201	VES-801-3-S202	VES-801-3-S205
Specs	B30 C30 E30 E32	E3	E3	B3 C3 E3
1. Valve Type	Ball	Ball	Ball	Ball
2. Sealing Type	Metal to Metal	Soft	Soft	Metal to Metal
3. Valve Specification Level (VSL)	VSL-3	VSL-3	VSL-3	VSL-3
4. Ball Mouting	Floating	Floating	Floating	Floating
5. Standard	ISO 17292	ISO 17292	ISO 17292	ISO 17292
6. Size Range (NPS)	½" - 1 ½"	½" - 1 ½"	½" - 1 ½"	½" - 1 ½"
7. End Connection	socket weld ends ASME B16.11 with nipple SCH 40S	socket weld ends ASME B16.11 with nipple SCH 40S	socket weld ends ASME B16.11 with nipple SCH 40S	socket weld ends ASME B16.11 with nipple SCH 40S
8. Pressure Class	800	800	800	800
9. Temperature	-100°C to 200°C	-30°C to 150°C	-46°C to 150°C	-100°C to 200°C
10. Material Class	Nickel Alloys	Stainless Steel	Stainless Steel	Stainless Steel
11. Body Material	ASTM B564 (UNS N06625)	ASTM A182 Gr F316/316L	ASTM A182 Gr F316/316L	ASTM A182 Gr F316/316L
12. Obturator Material	ASTM B564 (UNS N06625) + Hard Coating (acc. Item A.7.1.7.4)	AISI 316	AISI 316	AISI 316 + Hard Coating (acc. Item A.7.1.7.4)
13. Seat Material	ASTM B564 (UNS N06625) + Hard Coating (acc. Item A.7.1.7.4)	PTFE reinforced with 25% Carbon	PTFE reinforced with 25% Carbon	AISI 316 + Hard Coating (acc. Item A.7.1.7.4)
14. Seat Insert	N/A	N/A	N/A	N/A
15. Spring (Seat) Material	N/A	N/A	N/A	N/A
16. Stem Material	ASTM B637 (UNS N07718)	ASTM A276 (UNS S31600)	ASTM A276 (UNS S31600)	ASTM A276 (UNS S31600)
17. Seat-Stem Seal	Group E (acc. item A.7.1.5.6)	Group B (acc. item A.7.1.5.6)	Group E (acc. item A.7.1.5.6)	Group E (acc. item A.7.1.5.6)
18. Operator Type	Lever	Lever	Lever	Lever
19. Additional Requirement	Fire Tested (acc. item A.6.1.4)	Fire Tested (acc. item A.6.1.4)	Fire Tested (acc. item A.6.1.4)	Fire Tested (acc. item A.6.1.4)
20. Seat Type	N/A	N/A	N/A	N/A
21. Bore Type	Full Bore	Full Bore	Full Bore	Full Bore
22. Body Construction	split body, bolted	split body, bolted	split body, bolted	split body, bolted
23. Cladding or Coating	N/A	N/A	N/A	N/A
24. Valve Testing	FAT according A.9.3	FAT according A.9.3	FAT according A.9.3	FAT according A.9.3
25. Notes	N/A	N/A	N/A	N/A

Valve Code	VES-802-1-C105	VES-802-2-C105	VES-802-3-C105	VES-803-1-C101
Specs	B4	B4	B4	B9 B10 C9 C10 R9B R9C S9B S9C
1. Valve Type	Ball	Ball	Ball	Ball
2. Sealing Type	Metal to Metal	Metal to Metal	Metal to Metal	Soft
3. Valve Specification Level (VSL)	VSL-1	VSL-2	VSL-3	VSL-1
4. Ball Mouting	Floating	Floating	Floating	Floating
5. Standard	ISO 17292	ISO 17292	ISO 17292	ISO 17292
6. Size Range (NPS)	½" - 1 ½"	½" - 1 ½"	½" - 1 ½"	½" - 1 ½"
7. End Connection	socket weld ends ASME B16.11 with nipple SCH 80/80S	socket weld ends ASME B16.11 with nipple SCH 80/80S	socket weld ends ASME B16.11 with nipple SCH 80/80S	socket weld ends ASME B16.11 with nipple SCH 160
8. Pressure Class	800	800	800	800
9. Temperature	0°C to 210°C	0°C to 210°C	0°C to 210°C	0°C to 150°C
10. Material Class	Carbon Steel	Carbon Steel	Carbon Steel	Carbon Steel
11. Body Material	ASTM A105	ASTM A105	ASTM A105	ASTM A105
12. Obturator Material	AISI 410 + Hard Coating (acc. Item A.7.1.7.4)	AISI 410 + Hard Coating (acc. Item A.7.1.7.4)	AISI 410 + Hard Coating (acc. Item A.7.1.7.4)	AISI 410
13. Seat Material	AISI 410 + Hard Coating (acc. Item A.7.1.7.4)	AISI 410 + Hard Coating (acc. Item A.7.1.7.4)	AISI 410 + Hard Coating (acc. Item A.7.1.7.4)	PTFE reinforced with 25% Carbon
14. Seat Insert	N/A	N/A	N/A	N/A
15. Spring (Seat) Material	N/A	N/A	N/A	N/A
16. Stem Material	ASTM A276 (UNS S41000)	ASTM A276 (UNS S41000)	ASTM A276 (UNS S41000)	ASTM A276 (UNS S41000)
17. Seat-Stem Seal	Group D (acc. item A.7.1.5.6)	Group D (acc. item A.7.1.5.6)	Group D (acc. item A.7.1.5.6)	Group A (acc. item A.7.1.5.6)
18. Operator Type	Lever	Lever	Lever	Lever
19. Additional Requirement	Fire Tested (acc. item A.6.1.4)	Fire Tested (acc. item A.6.1.4)	Fire Tested (acc. item A.6.1.4)	Fire Tested (acc. item A.6.1.4)
20. Seat Type	N/A	N/A	N/A	N/A
21. Bore Type	Full Bore	Full Bore	Full Bore	Full Bore
22. Body Construction	split body, bolted	split body, bolted	split body, bolted	split body, bolted
23. Cladding or Coating	N/A	N/A	N/A	N/A
24. Valve Testing	FAT according A.9.3	FAT according A.9.3	FAT according A.9.3	FAT according A.9.3
25. Notes	N/A	N/A	N/A	N/A

Valve Code	VES-803-1-C102	VES-803-1-C103	VES-803-1-C104	VES-803-1-C105
Specs	B9 B10 C10	E9 E10	E10	B9 B10 C9 C10 E9 E10 S9B S9C
1. Valve Type	Ball	Ball	Ball	Ball
2. Sealing Type	Soft	Soft	Soft	Metal to Metal
3. Valve Specification Level (VSL)	VSL-1	VSL-1	VSL-1	VSL-1
4. Ball Mouting	Floating	Floating	Floating	Floating
5. Standard	ISO 17292	ISO 17292	ISO 17292	ISO 17292
6. Size Range (NPS)	½" - 1 ½"	½" - 1 ½"	½" - 1 ½"	½" - 1 ½"
7. End Connection	socket weld ends ASME B16.11 with nipple SCH 160	socket weld ends ASME B16.11 with nipple SCH 160	socket weld ends ASME B16.11 with nipple SCH 160	socket weld ends ASME B16.11 with nipple SCH 160
8. Pressure Class	800	800	800	800
9. Temperature	0°C to 150°C	0°C to 120°C	0°C to 150°C	0°C to 210°C
10. Material Class	Carbon Steel	Carbon Steel	Carbon Steel	Carbon Steel
11. Body Material	ASTM A105	ASTM A105	ASTM A105	ASTM A105
12. Obturator Material	AISI 410	AISI 410	AISI 410	AISI 410 + Hard Coating (acc. Item A.7.1.7.4)
13. Seat Material	PTFE reinforced with 25% Carbon	Devlon V-API	PEEK	AISI 410 + Hard Coating (acc. Item A.7.1.7.4)
14. Seat Insert	N/A	N/A	N/A	N/A
15. Spring (Seat) Material	N/A	N/A	N/A	N/A
16. Stem Material	ASTM A276 (UNS S41000)	ASTM A276 (UNS S41000)	ASTM A276 (UNS S41000)	ASTM A276 (UNS S41000)
17. Seat-Stem Seal	Group C (acc. item A.7.1.5.6)	Group A (acc. item A.7.1.5.6)	Group C (acc. item A.7.1.5.6)	Group D (acc. item A.7.1.5.6)
18. Operator Type	Lever	Lever	Lever	Lever
19. Additional Requirement	Fire Tested (acc. item A.6.1.4)	Fire Tested (acc. item A.6.1.4)	Fire Tested (acc. item A.6.1.4)	Fire Tested (acc. item A.6.1.4)
20. Seat Type	N/A	N/A	N/A	N/A
21. Bore Type	Full Bore	Full Bore	Full Bore	Full Bore
22. Body Construction	split body, bolted	split body, bolted	split body, bolted	split body, bolted
23. Cladding or Coating	N/A	N/A	N/A	N/A
24. Valve Testing	FAT according A.9.3	FAT according A.9.3	FAT according A.9.3	FAT according A.9.3
25. Notes	N/A	N/A	N/A	N/A

Valve Code	VES-803-1-C201	VES-803-1-C203	VES-803-1-C205	VES-803-2-C101
Specs	B6 B19 C6 C19 E6 E19	E6 E19	B6 B19 C6 C19 E6 E19	B9 B10 C9 C10 S9B S9C
1. Valve Type	Ball	Ball	Ball	Ball
2. Sealing Type	Soft	Soft	Metal to Metal	Soft
3. Valve Specification Level (VSL)	VSL-1	VSL-1	VSL-1	VSL-2
4. Ball Mouting	Floating	Floating	Floating	Floating
5. Standard	ISO 17292	ISO 17292	ISO 17292	ISO 17292
6. Size Range (NPS)	½" - 1 ½"	½" - 1 ½"	½" - 1 ½"	½" - 1 ½"
7. End Connection	socket weld ends ASME B16.11 with nipple SCH 160	socket weld ends ASME B16.11 with nipple SCH 160	socket weld ends ASME B16.11 with nipple SCH 160	socket weld ends ASME B16.11 with nipple SCH 160
8. Pressure Class	800	800	800	800
9. Temperature	-30°C to 150°C	-30°C to 120°C	-30°C to 200°C	-29°C to 150°C
10. Material Class	Carbon Steel	Carbon Steel	Carbon Steel	Carbon Steel
11. Body Material	ASTM A350 Gr LF2 CL1	ASTM A350 Gr LF2 CL1	ASTM A350 Gr LF2 CL1	ASTM A105
12. Obturator Material	AISI 316	AISI 316	AISI 316 + Hard Coating (acc. Item A.7.1.7.4)	AISI 410
13. Seat Material	PTFE reinforced with 25% Carbon	Devlon V-API	AISI 316 + Hard Coating (acc. Item A.7.1.7.4)	PTFE reinforced with 25% Carbon
14. Seat Insert	N/A	N/A	N/A	N/A
15. Spring (Seat) Material	N/A	N/A	N/A	N/A
16. Stem Material	ASTM A276 (UNS S31600)	ASTM A276 (UNS S31600)	ASTM A276 (UNS S31600)	ASTM A276 (UNS S41000)
17. Seat-Stem Seal	Group B (acc. item A.7.1.5.6)	Group B (acc. item A.7.1.5.6)	Group E (acc. item A.7.1.5.6)	Group B (acc. item A.7.1.5.6)
18. Operator Type	Lever	Lever	Lever	Lever
19. Additional Requirement	Fire Tested (acc. item A.6.1.4)	Fire Tested (acc. item A.6.1.4)	Fire Tested (acc. item A.6.1.4)	Fire Tested (acc. item A.6.1.4)
20. Seat Type	N/A	N/A	N/A	N/A
21. Bore Type	Full Bore	Full Bore	Full Bore	Full Bore
22. Body Construction	split body, bolted	split body, bolted	split body, bolted	split body, bolted
23. Cladding or Coating	N/A	N/A	N/A	N/A
24. Valve Testing	FAT according A.9.3	FAT according A.9.3	FAT according A.9.3	FAT according A.9.3
25. Notes	N/A	N/A	N/A	N/A

Valve Code	VES-803-2-C102	VES-803-2-C103	VES-803-2-C104	VES-803-2-C105
Specs	B9 B10 C10	E9 E10	E10	B9 B10 C9 C10 E9 E10 S9B S9C
1. Valve Type	Ball	Ball	Ball	Ball
2. Sealing Type	Soft	Soft	Soft	Metal to Metal
3. Valve Specification Level (VSL)	VSL-2	VSL-2	VSL-2	VSL-2
4. Ball Mouting	Floating	Floating	Floating	Floating
5. Standard	ISO 17292	ISO 17292	ISO 17292	ISO 17292
6. Size Range (NPS)	½" - 1 ½"	½" - 1 ½"	½" - 1 ½"	½" - 1 ½"
7. End Connection	socket weld ends ASME B16.11 with nipple SCH 160	socket weld ends ASME B16.11 with nipple SCH 160	socket weld ends ASME B16.11 with nipple SCH 160	socket weld ends ASME B16.11 with nipple SCH 160
8. Pressure Class	800	800	800	800
9. Temperature	0°C to 150°C	0°C to 120°C	0°C to 150°C	0°C to 210°C
10. Material Class	Carbon Steel	Carbon Steel	Carbon Steel	Carbon Steel
11. Body Material	ASTM A105	ASTM A105	ASTM A105	ASTM A105
12. Obturator Material	AISI 410	AISI 410	AISI 410	AISI 410 + Hard Coating (acc. Item A.7.1.7.4)
13. Seat Material	PTFE reinforced with 25% Carbon	Devlon V-API	PEEK	AISI 410 + Hard Coating (acc. Item A.7.1.7.4)
14. Seat Insert	N/A	N/A	N/A	N/A
15. Spring (Seat) Material	N/A	N/A	N/A	N/A
16. Stem Material	ASTM A276 (UNS S41000)	ASTM A276 (UNS S41000)	ASTM A276 (UNS S41000)	ASTM A276 (UNS S41000)
17. Seat-Stem Seal	Group C (acc. item A.7.1.5.6)	Group A (acc. item A.7.1.5.6)	Group C (acc. item A.7.1.5.6)	Group D (acc. item A.7.1.5.6)
18. Operator Type	Lever	Lever	Lever	Lever
19. Additional Requirement	Fire Tested (acc. item A.6.1.4)	Fire Tested (acc. item A.6.1.4)	Fire Tested (acc. item A.6.1.4)	Fire Tested (acc. item A.6.1.4)
20. Seat Type	N/A	N/A	N/A	N/A
21. Bore Type	Full Bore	Full Bore	Full Bore	Full Bore
22. Body Construction	split body, bolted	split body, bolted	split body, bolted	split body, bolted
23. Cladding or Coating	N/A	N/A	N/A	N/A
24. Valve Testing	FAT according A.9.3	FAT according A.9.3	FAT according A.9.3	FAT according A.9.3
25. Notes	N/A	N/A	N/A	N/A

Valve Code	VES-803-2-C201	VES-803-2-C202	VES-803-2-C203	VES-803-2-C205
Specs	B6 B19 C6 C19 E6 E19	E6 E19	E6 E19	B6 B19 C6 C19 E6 E19
1. Valve Type	Ball	Ball	Ball	Ball
2. Sealing Type	Soft	Soft	Soft	Metal to Metal
3. Valve Specification Level (VSL)	VSL-2	VSL-2	VSL-2	VSL-2
4. Ball Mouting	Floating	Floating	Floating	Floating
5. Standard	ISO 17292	ISO 17292	ISO 17292	ISO 17292
6. Size Range (NPS)	½" - 1 ½"	½" - 1 ½"	½" - 1 ½"	½" - 1 ½"
7. End Connection	socket weld ends ASME B16.11 with nipple SCH 160	socket weld ends ASME B16.11 with nipple SCH 160	socket weld ends ASME B16.11 with nipple SCH 160	socket weld ends ASME B16.11 with nipple SCH 160
8. Pressure Class	800	800	800	800
9. Temperature	-30°C to 150°C	-46°C to 150°C	-30°C to 120°C	-46°C to 200°C
10. Material Class	Carbon Steel	Carbon Steel	Carbon Steel	Carbon Steel
11. Body Material	ASTM A350 Gr LF2 CL1	ASTM A350 Gr LF2 CL1	ASTM A350 Gr LF2 CL1	ASTM A350 Gr LF2 CL1
12. Obturator Material	AISI 316	AISI 316	AISI 316	AISI 316 + Hard Coating (acc. Item A.7.1.7.4)
13. Seat Material	PTFE reinforced with 25% Carbon	PTFE reinforced with 25% Carbon	Devlon V-API	AISI 316 + Hard Coating (acc. Item A.7.1.7.4)
14. Seat Insert	N/A	N/A	N/A	N/A
15. Spring (Seat) Material	N/A	N/A	N/A	N/A
16. Stem Material	ASTM A276 (UNS S31600)	ASTM A276 (UNS S31600)	ASTM A276 (UNS S31600)	ASTM A276 (UNS S31600)
17. Seat-Stem Seal	Group B (acc. item A.7.1.5.6)	Group E (acc. item A.7.1.5.6)	Group B (acc. item A.7.1.5.6)	Group E (acc. item A.7.1.5.6)
18. Operator Type	Lever	Lever	Lever	Lever
19. Additional Requirement	Fire Tested (acc. item A.6.1.4)	Fire Tested (acc. item A.6.1.4)	Fire Tested (acc. item A.6.1.4)	Fire Tested (acc. item A.6.1.4)
20. Seat Type	N/A	N/A	N/A	N/A
21. Bore Type	Full Bore	Full Bore	Full Bore	Full Bore
22. Body Construction	split body, bolted	split body, bolted	split body, bolted	split body, bolted
23. Cladding or Coating	N/A	N/A	N/A	N/A
24. Valve Testing	FAT according A.9.3	FAT according A.9.3	FAT according A.9.3	FAT according A.9.3
25. Notes	N/A	N/A	N/A	N/A

Valve Code	VES-803-3-C105	VES-803-3-C201	VES-803-3-C202	VES-803-3-C205
Specs	B9 B10 C9 C10 E9 E10	E6	E6	B6 B19 C6 C19 E6 E19
1. Valve Type	Ball	Ball	Ball	Ball
2. Sealing Type	Metal to Metal	Soft	Soft	Metal to Metal
3. Valve Specification Level (VSL)	VSL-3	VSL-3	VSL-3	VSL-3
4. Ball Mouting	Floating	Floating	Floating	Floating
5. Standard	ISO 17292	ISO 17292	ISO 17292	ISO 17292
6. Size Range (NPS)	½" - 1 ½"	½" - 1 ½"	½" - 1 ½"	½" - 1 ½"
7. End Connection	socket weld ends ASME B16.11 with nipple SCH 160	socket weld ends ASME B16.11 with nipple SCH 160	socket weld ends ASME B16.11 with nipple SCH 160	socket weld ends ASME B16.11 with nipple SCH 160
8. Pressure Class	800	800	800	800
9. Temperature	0°C to 210°C	-30°C to 150°C	-46°C to 150°C	-30°C to 200°C
10. Material Class	Carbon Steel	Carbon Steel	Carbon Steel	Carbon Steel
11. Body Material	ASTM A105	ASTM A350 Gr LF2 CL1	ASTM A350 Gr LF2 CL1	ASTM A350 Gr LF2 CL1
12. Obturator Material	AISI 410 + Hard Coating (acc. Item A.7.1.7.4)	AISI 316	AISI 316	AISI 316 + Hard Coating (acc. Item A.7.1.7.4)
13. Seat Material	AISI 410 + Hard Coating (acc. Item A.7.1.7.4)	PTFE reinforced with 25% Carbon	PTFE reinforced with 25% Carbon	AISI 316 + Hard Coating (acc. Item A.7.1.7.4)
14. Seat Insert	N/A	N/A	N/A	N/A
15. Spring (Seat) Material	N/A	N/A	N/A	N/A
16. Stem Material	ASTM A276 (UNS S41000)	ASTM A276 (UNS S31600)	ASTM A276 (UNS S31600)	ASTM A276 (UNS S31600)
17. Seat-Stem Seal	Group D (acc. item A.7.1.5.6)	Group B (acc. item A.7.1.5.6)	Group E (acc. item A.7.1.5.6)	Group E (acc. item A.7.1.5.6)
18. Operator Type	Lever	Lever	Lever	Lever
19. Additional Requirement	Fire Tested (acc. item A.6.1.4)	Fire Tested (acc. item A.6.1.4)	Fire Tested (acc. item A.6.1.4)	Fire Tested (acc. item A.6.1.4)
20. Seat Type	N/A	N/A	N/A	N/A
21. Bore Type	Full Bore	Full Bore	Full Bore	Full Bore
22. Body Construction	split body, bolted	split body, bolted	split body, bolted	split body, bolted
23. Cladding or Coating	N/A	N/A	N/A	N/A
24. Valve Testing	FAT according A.9.3	FAT according A.9.3	FAT according A.9.3	FAT according A.9.3
25. Notes	N/A	N/A	N/A	N/A

Valve Code	VES-900-1-C112		VES-900-1-C114		VES-900-1-C134		VES-900-1-C150	
Specs	F10		F10		F10		F10	
1. Valve Type	Ball		Ball		Ball		Ball	
2. Sealing Type	Soft		Soft		Soft		Metal to Metal	
3. Valve Specification Level (VSL)	VSL-1		VSL-1		VSL-1		VSL-1	
4. Ball Mouting	Trunnion		Trunnion		Trunnion		Trunnion	
5. Standard	API 6D / IOGP S-562		API 6D / IOGP S-562		API 6D / IOGP S-562		API 6D / IOGP S-562	
6. Size Range (NPS)	2" - 24"		2" - 24"		2" - 24"		2" - 24"	
7. End Connection	ASME B16.5, RTJ		ASME B16.5, RTJ		ASME B16.5, RTJ		ASME B16.5, RTJ	
8. Pressure Class	900		900		900		900	
9. Temperature	-29°C to 120°C		-29°C to 150°C		0°C to 150°C		0°C to 150°C	
10. Material Class	Carbon Steel		Carbon Steel		Carbon Steel		Carbon Steel	
11. Body Material	ASTM A105 or ASTM A216 Gr WCB + SS316 weld overlay (acc. item A.7.1.7.3)		ASTM A105 or ASTM A216 Gr WCB + SS316 weld overlay (acc. item A.7.1.7.3)		ASTM A105 or ASTM A216 Gr WCB + SS316 weld overlay (acc. item A.7.1.7.3)		ASTM A105 or ASTM A216 Gr WCB + SS316 weld overlay (acc. item A.7.1.7.3)	
12. Obturator Material	AISI 410		AISI 410		AISI 410		AISI 410 + Tungsten carbide coating	
13. Seat Material	AISI 410		AISI 410		AISI 410		AISI 410 + Tungsten carbide coating	
14. Seat Insert	Devlon V-API		PEEK		PEEK		N/A	
15. Spring (Seat) Material	UNS N07750		UNS N07750		UNS N07750		UNS N07750	
16. Stem Material	ASTM A276 (UNS S41000)		ASTM A276 (UNS S41000)		ASTM A276 (UNS S41000)		ASTM A276 (UNS S41000)	
17. Seat-Stem Seal	Group B (acc. item A.7.1.5.6)		Group B (acc. item A.7.1.5.6)		Group D (acc. item A.7.1.5.6)		Group A (acc. item A.7.1.5.6)	
18. Operator Type	2" - 3"	Lever	2" - 3"	Lever	2" - 3"	Lever	2" - 3"	Lever
	4" - 24"	Gearbox	4" - 24"	Gearbox	4" - 24"	Gearbox	4" - 24"	Gearbox
19. Additional Requirement	N/A		N/A		N/A		N/A	
20. Seat Type	Side A: SPE / Side B: SPE		Side A: SPE / Side B: SPE; DBB		Side A: SPE / Side B: SPE; DBB		Side A: SPE / Side B: SPE	
21. Bore Type	Full Bore		Full Bore		Full Bore		Full Bore	
22. Body Construction	split body, bolted		split body, bolted		split body, bolted		split body, bolted	
23. Cladding or Coating	Partial clad - SS316 weld overlay on all body sealing areas		Partial clad - SS316 weld overlay on all body sealing areas		Partial clad - SS316 weld overlay on all body sealing areas		Partial clad - SS316 weld overlay on all body sealing areas	
24. Valve Testing	FAT according A.9.3		FAT according A.9.3		FAT according A.9.3		FAT according A.9.3	
25. Notes	N/A		N/A		N/A		N/A	

Valve Code	VES-900-1-C160		VES-900-1-C170		VES-900-1-C214		VES-900-1-C234	
Specs	F10		F10		F6		F6	
1. Valve Type	Ball		Ball		Ball		Ball	
2. Sealing Type	Metal to Metal		Metal to Metal		Soft		Soft	
3. Valve Specification Level (VSL)	VSL-1		VSL-1		VSL-1		VSL-1	
4. Ball Mouting	Trunnion		Trunnion		Trunnion		Trunnion	
5. Standard	API 6D		API 6D		API 6D / IOGP S-562		API 6D / IOGP S-562	
6. Size Range (NPS)	2" - 24"		2" - 24"		2" - 4"		2" - 4"	
7. End Connection	ASME B16.5, RTJ		ASME B16.5, RTJ		ASME B16.5, RTJ		ASME B16.5, RTJ	
8. Pressure Class	900		900		900		900	
9. Temperature	0°C to 210°C		0°C to 210°C		-30°C to 150°C		-46°C to 150°C	
10. Material Class	Carbon Steel		Carbon Steel		Carbon Steel		Carbon Steel	
11. Body Material	ASTM A105 or ASTM A216 Gr WCB + SS316 weld overlay (acc. item A.7.1.7.3)		ASTM A105 or ASTM A216 Gr WCB + SS316 weld overlay (acc. item A.7.1.7.3)		ASTM A350 Gr LF2 CL1 or ASTM A352 Gr LCB + Inconel 625 weld overlay (acc. item A.7.1.7.3)		ASTM A350 Gr LF2 CL1 or ASTM A352 Gr LCB + Inconel 625 weld overlay (acc. item A.7.1.7.3)	
12. Obturator Material	AISI 410 + Tungsten carbide coating		AISI 410 + Tungsten carbide coating		AISI 316		AISI 316	
13. Seat Material	AISI 410 + Tungsten carbide coating		AISI 410 + Tungsten carbide coating		AISI 316		AISI 316	
14. Seat Insert	N/A		N/A		PEEK		PEEK	
15. Spring (Seat) Material	UNS N07750		UNS N07750		UNS N07750		UNS N07750	
16. Stem Material	ASTM A276 (UNS S41000)		ASTM A276 (UNS S41000)		ASTM A276 (UNS S31600)		ASTM A276 (UNS S31600)	
17. Seat-Stem Seal	Group C (acc. item A.7.1.5.6)		Group D (acc. item A.7.1.5.6)		Group B (acc. item A.7.1.5.6)		Group E (acc. item A.7.1.5.6)	
18. Operator Type	2" - 3"	Lever	2" - 3"	Lever	2" - 3"	Lever	2" - 3"	Lever
	4" - 24"	Gearbox	4" - 24"	Gearbox	4"	Gearbox	4"	Gearbox
19. Additional Requirement	N/A		N/A		N/A		N/A	
20. Seat Type	Side A: SPE / Side B: SPE		Side A: SPE / Side B: SPE		Side A: SPE / Side B: SPE; DBB		Side A: SPE / Side B: SPE; DBB	
21. Bore Type	Full Bore		Full Bore		Full Bore		Full Bore	
22. Body Construction	split body, bolted		split body, bolted		split body, bolted		split body, bolted	
23. Cladding or Coating	Partial clad - SS316 weld overlay on all body sealing areas		Partial clad - SS316 weld overlay on all body sealing areas		Partial clad - Inconel 625 weld overlay on all body sealing areas		Partial clad - Inconel 625 weld overlay on all body sealing areas	
24. Valve Testing	FAT according A.9.3		FAT according A.9.3		FAT according A.9.3		FAT according A.9.3	
25. Notes	N/A		N/A		N/A		N/A	

Valve Code	VES-900-1-C250		VES-900-1-C270		VES-900-1-S214		VES-900-1-S222	
Specs	F6		F6		F3		F3	
1. Valve Type	Ball		Ball		Ball		Ball	
2. Sealing Type	Metal to Metal		Metal to Metal		Soft		Soft	
3. Valve Specification Level (VSL)	VSL-1		VSL-1		VSL-1		VSL-1	
4. Ball Mouting	Trunnion		Trunnion		Trunnion		Trunnion	
5. Standard	API 6D / IOGP S-562		API 6D		API 6D / IOGP S-562		API 6D / IOGP S-562	
6. Size Range (NPS)	2" - 4"		2" - 4"		2" - 18"		2" - 18"	
7. End Connection	ASME B16.5, RTJ		ASME B16.5, RTJ		ASME B16.5, RTJ		ASME B16.5, RTJ	
8. Pressure Class	900		900		900		900	
9. Temperature	-30°C to 150°C		-46°C to 200°C		-30°C to 150°C		0°C to 120°C	
10. Material Class	Carbon Steel		Carbon Steel		Stainless Steel		Stainless Steel	
11. Body Material	ASTM A350 Gr LF2 CL1 or ASTM A352 Gr LCB + Inconel 625 weld overlay (acc. item A.7.1.7.3)		ASTM A350 Gr LF2 CL1 or ASTM A352 Gr LCB + Inconel 625 weld overlay (acc. item A.7.1.7.3)		ASTM A182 Gr F316 or ASTM A351 Gr CF8M		ASTM A182 Gr F316 or ASTM A351 Gr CF8M	
12. Obturator Material	AISI 316 + Tungsten carbide coating		AISI 316 + Tungsten carbide coating		AISI 316		AISI 316	
13. Seat Material	AISI 316 + Tungsten carbide coating		AISI 316 + Tungsten carbide coating		AISI 316		AISI 316	
14. Seat Insert	N/A		N/A		PEEK		Devlon V-API	
15. Spring (Seat) Material	UNS N07750		UNS N07750		UNS N07750		UNS N07750	
16. Stem Material	ASTM A276 (UNS S31600)		ASTM A276 (UNS S31600)		ASTM A276 (UNS S31600)		ASTM A276 (UNS S31600)	
17. Seat-Stem Seal	Group B (acc. item A.7.1.5.6)		Group E (acc. item A.7.1.5.6)		Group B (acc. item A.7.1.5.6)		Group C (acc. item A.7.1.5.6)	
18. Operator Type	2" - 3"	Lever	2" - 3"	Lever	2" - 3"	Lever	2" - 3"	Lever
	4"	Gearbox	4"	Gearbox	4" - 18"	Gearbox	4" - 18"	Gearbox
19. Additional Requirement	N/A		N/A		N/A		N/A	
20. Seat Type	Side A: SPE / Side B: SPE		Side A: SPE / Side B: SPE		Side A: SPE / Side B: SPE; DBB		Side A: SPE / Side B: SPE	
21. Bore Type	Full Bore		Full Bore		Full Bore		Full Bore	
22. Body Construction	split body, bolted		split body, bolted		split body, bolted		split body, bolted	
23. Cladding or Coating	Partial clad - Inconel 625 weld overlay on all body sealing areas		Partial clad - Inconel 625 weld overlay on all body sealing areas		N/A		N/A	
24. Valve Testing	FAT according A.9.3		FAT according A.9.3		FAT according A.9.3		FAT according A.9.3	
25. Notes	N/A		N/A		N/A		N/A	

Valve Code	VES-900-1-S224		VES-900-1-S234		VES-900-1-S250		VES-900-1-S260	
Specs	F3		F3		F3		F3	
1. Valve Type	Ball		Ball		Ball		Ball	
2. Sealing Type	Soft		Soft		Metal to Metal		Metal to Metal	
3. Valve Specification Level (VSL)	VSL-1		VSL-1		VSL-1		VSL-1	
4. Ball Mouting	Trunnion		Trunnion		Trunnion		Trunnion	
5. Standard	API 6D / IOGP S-562		API 6D / IOGP S-562		API 6D / IOGP S-562		API 6D	
6. Size Range (NPS)	2" - 18"		2" - 18"		2" - 18"		2" - 18"	
7. End Connection	ASME B16.5, RTJ		ASME B16.5, RTJ		ASME B16.5, RTJ		ASME B16.5, RTJ	
8. Pressure Class	900		900		900		900	
9. Temperature	0°C to 150°C		-46°C to 150°C		-30°C to 150°C		0°C to 210°C	
10. Material Class	Stainless Steel		Stainless Steel		Stainless Steel		Stainless Steel	
11. Body Material	ASTM A182 Gr F316 or ASTM A351 Gr CF8M		ASTM A182 Gr F316 or ASTM A351 Gr CF8M		ASTM A182 Gr F316 or ASTM A351 Gr CF8M		ASTM A182 Gr F316 or ASTM A351 Gr CF8M	
12. Obturator Material	AISI 316		AISI 316		AISI 316 + Tungsten carbide coating		AISI 316 + Tungsten carbide coating	
13. Seat Material	AISI 316		AISI 316		AISI 316 + Tungsten carbide coating		AISI 316 + Tungsten carbide coating	
14. Seat Insert	PEEK		PEEK		N/A		N/A	
15. Spring (Seat) Material	UNS N07750		UNS N07750		UNS N07750		UNS N07750	
16. Stem Material	ASTM A276 (UNS S31600)		ASTM A276 (UNS S31600)		ASTM A276 (UNS S31803)		ASTM A276 (UNS S31803)	
17. Seat-Stem Seal	Group C (acc. item A.7.1.5.6)		Group E (acc. item A.7.1.5.6)		Group B (acc. item A.7.1.5.6)		Group C (acc. item A.7.1.5.6)	
18. Operator Type	2" - 3"	Lever	2" - 3"	Lever	2" - 3"	Lever	2" - 3"	Lever
	4" - 18"	Gearbox		4" - 18"		Gearbox		4" - 18"
19. Additional Requirement	N/A		N/A		N/A		N/A	
20. Seat Type	Side A: SPE / Side B: SPE; DBB		Side A: SPE / Side B: SPE; DBB		Side A: SPE / Side B: SPE		Side A: SPE / Side B: SPE	
21. Bore Type	Full Bore		Full Bore		Full Bore		Full Bore	
22. Body Construction	split body, bolted		split body, bolted		split body, bolted		split body, bolted	
23. Cladding or Coating	N/A		N/A		N/A		N/A	
24. Valve Testing	FAT according A.9.3		FAT according A.9.3		FAT according A.9.3		FAT according A.9.3	
25. Notes	N/A		N/A		N/A		N/A	

Valve Code	VES-900-1-S270		VES-900-2-C114		VES-900-2-C118		VES-900-2-C134	
Specs	F3		F10		F10		F10	
1. Valve Type	Ball		Ball		Ball		Ball	
2. Sealing Type	Metal to Metal		Soft		Soft		Soft	
3. Valve Specification Level (VSL)	VSL-1		VSL-2		VSL-2		VSL-2	
4. Ball Mouting	Trunnion		Trunnion		Trunnion		Trunnion	
5. Standard	API 6D		API 6D / IOGP S-562		API 6D / IOGP S-562		API 6D / IOGP S-562	
6. Size Range (NPS)	2" - 18"		2" - 24"		2" - 24"		2" - 24"	
7. End Connection	ASME B16.5, RTJ		ASME B16.5, RTJ		ASME B16.5, RTJ		ASME B16.5, RTJ	
8. Pressure Class	900		900		900		900	
9. Temperature	-46°C to 200°C		-29°C to 150°C		-29°C to 150°C		0°C to 150°C	
10. Material Class	Stainless Steel		Carbon Steel		Carbon Steel		Carbon Steel	
11. Body Material	ASTM A182 Gr F316 or ASTM A351 Gr CF8M		ASTM A105 or ASTM A216 Gr WCB + SS316 weld overlay (acc. item A.7.1.7.3)		ASTM A105 or ASTM A216 Gr WCB + SS316 weld overlay (acc. item A.7.1.7.3)		ASTM A105 or ASTM A216 Gr WCB + SS316 weld overlay (acc. item A.7.1.7.3)	
12. Obturator Material	AISI 316 + Tungsten carbide coating		AISI 410		AISI 410		AISI 410	
13. Seat Material	AISI 316 + Tungsten carbide coating		AISI 410		AISI 410		AISI 410	
14. Seat Insert	N/A		PEEK		PEEK		PEEK	
15. Spring (Seat) Material	UNS N07750		UNS N07750		UNS N07750		UNS N07750	
16. Stem Material	ASTM A276 (UNS S31803)		ASTM A276 (UNS S41000)		ASTM A276 (UNS S41000)		ASTM A276 (UNS S41000)	
17. Seat-Stem Seal	Group E (acc. item A.7.1.5.6)		Group B (acc. item A.7.1.5.6)		Group B (acc. item A.7.1.5.6)		Group D (acc. item A.7.1.5.6)	
18. Operator Type	2" - 3"	Lever	2" - 3"	Lever	2" - 3"	Lever	2" - 3"	Lever
	4" - 18"	Gearbox	4" - 24"	Gearbox	4" - 24"	Gearbox	4" - 24"	Gearbox
19. Additional Requirement	N/A		N/A		N/A		N/A	
20. Seat Type	Side A: SPE / Side B: SPE		Side A: SPE / Side B: SPE; DBB		Side A: SPE / Side B: DPE; DIB-2 & DBB		Side A: SPE / Side B: SPE; DBB	
21. Bore Type	Full Bore		Full Bore		Full Bore		Full Bore	
22. Body Construction	split body, bolted		split body, bolted		split body, bolted		split body, bolted	
23. Cladding or Coating	N/A		Partial clad - SS316 weld overlay on all body sealing areas		Partial clad - SS316 weld overlay on all body sealing areas		Partial clad - SS316 weld overlay on all body sealing areas	
24. Valve Testing	FAT according A.9.3		FAT according A.9.3		FAT according A.9.3		FAT according A.9.3	
25. Notes	N/A		N/A		N/A		N/A	

Valve Code	VES-900-2-C138		VES-900-2-C150		VES-900-2-C152		VES-900-2-C160	
Specs	F10		F10		F10		F10	
1. Valve Type	Ball		Ball		Ball		Ball	
2. Sealing Type	Soft		Metal to Metal		Metal to Metal		Metal to Metal	
3. Valve Specification Level (VSL)	VSL-2		VSL-2		VSL-2		VSL-2	
4. Ball Mouting	Trunnion		Trunnion		Trunnion		Trunnion	
5. Standard	API 6D / IOGP S-562		API 6D / IOGP S-562		API 6D / IOGP S-562		API 6D	
6. Size Range (NPS)	2" - 24"		2" - 24"		2" - 24"		2" - 24"	
7. End Connection	ASME B16.5, RTJ		ASME B16.5, RTJ		ASME B16.5, RTJ		ASME B16.5, RTJ	
8. Pressure Class	900		900		900		900	
9. Temperature	0°C to 150°C		0°C to 150°C		0°C to 150°C		0°C to 210°C	
10. Material Class	Carbon Steel		Carbon Steel		Carbon Steel		Carbon Steel	
11. Body Material	ASTM A105 or ASTM A216 Gr WCB + SS316 weld overlay (acc. item A.7.1.7.3)		ASTM A105 or ASTM A216 Gr WCB + SS316 weld overlay (acc. item A.7.1.7.3)		ASTM A105 or ASTM A216 Gr WCB + SS316 weld overlay (acc. item A.7.1.7.3)		ASTM A105 or ASTM A216 Gr WCB + SS316 weld overlay (acc. item A.7.1.7.3)	
12. Obturator Material	AISI 410		AISI 410 + Tungsten carbide coating		AISI 410 + Tungsten carbide coating		AISI 410 + Tungsten carbide coating	
13. Seat Material	AISI 410		AISI 410 + Tungsten carbide coating		AISI 410 + Tungsten carbide coating		AISI 410 + Tungsten carbide coating	
14. Seat Insert	PEEK		N/A		N/A		N/A	
15. Spring (Seat) Material	UNS N07750		UNS N07750		UNS N07750		UNS N07750	
16. Stem Material	ASTM A276 (UNS S41000)		ASTM A276 (UNS S41000)		ASTM A276 (UNS S41000)		ASTM A276 (UNS S41000)	
17. Seat-Stem Seal	Group D (acc. item A.7.1.5.6)		Group B (acc. item A.7.1.5.6)		Group B (acc. item A.7.1.5.6)		Group C (acc. item A.7.1.5.6)	
18. Operator Type	2" - 3"	Lever	2" - 3"	Lever	2" - 3"	Lever	2" - 3"	Lever
	4" - 24"	Gearbox	4" - 24"	Gearbox	4" - 24"	Gearbox	4" - 24"	Gearbox
19. Additional Requirement	N/A		N/A		N/A		N/A	
20. Seat Type	Side A: SPE / Side B: DPE; DIB-2 & DBB		Side A: SPE / Side B: SPE		Side A: SPE / Side B: DPE; DIB-2 & DBB		Side A: SPE / Side B: SPE	
21. Bore Type	Full Bore		Full Bore		Full Bore		Full Bore	
22. Body Construction	split body, bolted		split body, bolted		split body, bolted		split body, bolted	
23. Cladding or Coating	Partial clad - SS316 weld overlay on all body sealing areas		Partial clad - SS316 weld overlay on all body sealing areas		Partial clad - SS316 weld overlay on all body sealing areas		Partial clad - SS316 weld overlay on all body sealing areas	
24. Valve Testing	FAT according A.9.3		FAT according A.9.3		FAT according A.9.3		FAT according A.9.3	
25. Notes	N/A		N/A		N/A		N/A	

Valve Code	VES-900-2-C162		VES-900-2-C170		VES-900-2-C172		VES-900-2-C214	
Specs	F10		F10		F10		F6	
1. Valve Type	Ball		Ball		Ball		Ball	
2. Sealing Type	Metal to Metal		Metal to Metal		Metal to Metal		Soft	
3. Valve Specification Level (VSL)	VSL-2		VSL-2		VSL-2		VSL-2	
4. Ball Mouting	Trunnion		Trunnion		Trunnion		Trunnion	
5. Standard	API 6D		API 6D		API 6D		API 6D / IOGP S-562	
6. Size Range (NPS)	2" - 24"		2" - 24"		2" - 24"		2" - 20"	
7. End Connection	ASME B16.5, RTJ		ASME B16.5, RTJ		ASME B16.5, RTJ		ASME B16.5, RTJ	
8. Pressure Class	900		900		900		900	
9. Temperature	0°C to 210°C		0°C to 210°C		0°C to 210°C		-30°C to 150°C	
10. Material Class	Carbon Steel		Carbon Steel		Carbon Steel		Carbon Steel	
11. Body Material	ASTM A105 or ASTM A216 Gr WCB + SS316 weld overlay (acc. item A.7.1.7.3)		ASTM A105 or ASTM A216 Gr WCB + SS316 weld overlay (acc. item A.7.1.7.3)		ASTM A105 or ASTM A216 Gr WCB + SS316 weld overlay (acc. item A.7.1.7.3)		ASTM A350 Gr LF2 CL1 or ASTM A352 Gr LCB + Inconel 625 weld overlay (acc. item A.7.1.7.3)	
12. Obturator Material	AISI 410 + Tungsten carbide coating		AISI 410 + Tungsten carbide coating		AISI 410 + Tungsten carbide coating		AISI 316	
13. Seat Material	AISI 410 + Tungsten carbide coating		AISI 410 + Tungsten carbide coating		AISI 410 + Tungsten carbide coating		AISI 316	
14. Seat Insert	N/A		N/A		N/A		PEEK	
15. Spring (Seat) Material	UNS N07750		UNS N07750		UNS N07750		UNS N07750	
16. Stem Material	ASTM A276 (UNS S41000)		ASTM A276 (UNS S41000)		ASTM A276 (UNS S41000)		ASTM A276 (UNS S31600)	
17. Seat-Stem Seal	Group C (acc. item A.7.1.5.6)		Group D (acc. item A.7.1.5.6)		Group D (acc. item A.7.1.5.6)		Group B (acc. item A.7.1.5.6)	
18. Operator Type	2" - 3"	Lever	2" - 3"	Lever	2" - 3"	Lever	2" - 3"	Lever
	4" - 24"	Gearbox	4" - 24"	Gearbox	4" - 24"	Gearbox	4" - 20"	Gearbox
19. Additional Requirement	N/A		N/A		N/A		N/A	
20. Seat Type	Side A: SPE / Side B: DPE; DIB-2 & DBB		Side A: SPE / Side B: SPE		Side A: SPE / Side B: DPE; DIB-2 & DBB		Side A: SPE / Side B: SPE; DBB	
21. Bore Type	Full Bore		Full Bore		Full Bore		Full Bore	
22. Body Construction	split body, bolted		split body, bolted		split body, bolted		split body, bolted	
23. Cladding or Coating	Partial clad - SS316 weld overlay on all body sealing areas		Partial clad - SS316 weld overlay on all body sealing areas		Partial clad - SS316 weld overlay on all body sealing areas		Partial clad - Inconel 625 weld overlay on all body sealing areas	
24. Valve Testing	FAT according A.9.3		FAT according A.9.3		FAT according A.9.3		FAT according A.9.3	
25. Notes	N/A		N/A		N/A		N/A	

Valve Code	VES-900-2-C218		VES-900-2-C234		VES-900-2-C238		VES-900-2-C250	
Specs	F6		F6		F6		F6	
1. Valve Type	Ball		Ball		Ball		Ball	
2. Sealing Type	Soft		Soft		Soft		Metal to Metal	
3. Valve Specification Level (VSL)	VSL-2		VSL-2		VSL-2		VSL-2	
4. Ball Mouting	Trunnion		Trunnion		Trunnion		Trunnion	
5. Standard	API 6D / IOGP S-562		API 6D / IOGP S-562		API 6D / IOGP S-562		API 6D / IOGP S-562	
6. Size Range (NPS)	2" - 20"		2" - 20"		2" - 20"		2" - 20"	
7. End Connection	ASME B16.5, RTJ		ASME B16.5, RTJ		ASME B16.5, RTJ		ASME B16.5, RTJ	
8. Pressure Class	900		900		900		900	
9. Temperature	-30°C to 150°C		-46°C to 150°C		-46°C to 150°C		-30°C to 150°C	
10. Material Class	Carbon Steel		Carbon Steel		Carbon Steel		Carbon Steel	
11. Body Material	ASTM A350 Gr LF2 CL1 or ASTM A352 Gr LCB + Inconel 625 weld overlay (acc. item A.7.1.7.3)		ASTM A350 Gr LF2 CL1 or ASTM A352 Gr LCB + Inconel 625 weld overlay (acc. item A.7.1.7.3)		ASTM A350 Gr LF2 CL1 or ASTM A352 Gr LCB + Inconel 625 weld overlay (acc. item A.7.1.7.3)		ASTM A350 Gr LF2 CL1 or ASTM A352 Gr LCB + Inconel 625 weld overlay (acc. item A.7.1.7.3)	
12. Obturator Material	AISI 316		AISI 316		AISI 316		AISI 316 + Tungsten carbide coating	
13. Seat Material	AISI 316		AISI 316		AISI 316		AISI 316 + Tungsten carbide coating	
14. Seat Insert	PEEK		PEEK		PEEK		N/A	
15. Spring (Seat) Material	UNS N07750		UNS N07750		UNS N07750		UNS N07750	
16. Stem Material	ASTM A276 (UNS S31600)		ASTM A276 (UNS S31600)		ASTM A276 (UNS S31600)		ASTM A276 (UNS S31600)	
17. Seat-Stem Seal	Group B (acc. item A.7.1.5.6)		Group E (acc. item A.7.1.5.6)		Group E (acc. item A.7.1.5.6)		Group B (acc. item A.7.1.5.6)	
18. Operator Type	2" - 3"	Lever	2" - 3"	Lever	2" - 3"	Lever	2" - 3"	Lever
	4" - 20"	Gearbox	4" - 20"	Gearbox	4" - 20"	Gearbox	4" - 20"	Gearbox
19. Additional Requirement	N/A		N/A		N/A		N/A	
20. Seat Type	Side A: SPE / Side B: DPE; DIB-2 & DBB		Side A: SPE / Side B: SPE; DBB		Side A: SPE / Side B: DPE; DIB-2 & DBB		Side A: SPE / Side B: SPE	
21. Bore Type	Full Bore		Full Bore		Full Bore		Full Bore	
22. Body Construction	split body, bolted		split body, bolted		split body, bolted		split body, bolted	
23. Cladding or Coating	Partial clad - Inconel 625 weld overlay on all body sealing areas		Partial clad - Inconel 625 weld overlay on all body sealing areas		Partial clad - Inconel 625 weld overlay on all body sealing areas		Partial clad - Inconel 625 weld overlay on all body sealing areas	
24. Valve Testing	FAT according A.9.3		FAT according A.9.3		FAT according A.9.3		FAT according A.9.3	
25. Notes	N/A		N/A		N/A		N/A	

Valve Code	VES-900-2-C252		VES-900-2-C270		VES-900-2-C272		VES-900-2-C280	
Specs	F6		F6		F6		F6	
1. Valve Type	Ball		Ball		Ball		Ball	
2. Sealing Type	Metal to Metal		Metal to Metal		Metal to Metal		Metal to Metal	
3. Valve Specification Level (VSL)	VSL-2		VSL-2		VSL-2		VSL-2	
4. Ball Mouting	Trunnion		Trunnion		Trunnion		Trunnion	
5. Standard	API 6D / IOGP S-562		API 6D		API 6D		API 6D	
6. Size Range (NPS)	2" - 20"		2" - 20"		2" - 20"		2" - 20"	
7. End Connection	ASME B16.5, RTJ		ASME B16.5, RTJ		ASME B16.5, RTJ		ASME B16.5, RTJ	
8. Pressure Class	900		900		900		900	
9. Temperature	-30°C to 150°C		-46°C to 200°C		-46°C to 200°C		-46°C to 340°C	
10. Material Class	Carbon Steel		Carbon Steel		Carbon Steel		Carbon Steel	
11. Body Material	ASTM A350 Gr LF2 CL1 or ASTM A352 Gr LCB + Inconel 625 weld overlay (acc. item A.7.1.7.3)		ASTM A350 Gr LF2 CL1 or ASTM A352 Gr LCB + Inconel 625 weld overlay (acc. item A.7.1.7.3)		ASTM A350 Gr LF2 CL1 or ASTM A352 Gr LCB + Inconel 625 weld overlay (acc. item A.7.1.7.3)		ASTM A350 Gr LF2 CL1 or ASTM A352 Gr LCB + Inconel 625 weld overlay (acc. item A.7.1.7.3)	
12. Obturator Material	AISI 316 + Tungsten carbide coating		AISI 316 + Tungsten carbide coating		AISI 316 + Tungsten carbide coating		AISI 316 + Chrome-Nickel Spray and Fuse (acc. Item A.8.2.2.4)	
13. Seat Material	AISI 316 + Tungsten carbide coating		AISI 316 + Tungsten carbide coating		AISI 316 + Tungsten carbide coating		AISI 316 + Chrome-Nickel Spray and Fuse (acc. Item A.8.2.2.4)	
14. Seat Insert	N/A		N/A		N/A		N/A	
15. Spring (Seat) Material	UNS N07750		UNS N07750		UNS N07750		UNS N07750	
16. Stem Material	ASTM A276 (UNS S31600)		ASTM A276 (UNS S31600)		ASTM A276 (UNS S31600)		ASTM A276 (UNS S31600)	
17. Seat-Stem Seal	Group B (acc. item A.7.1.5.6)		Group E (acc. item A.7.1.5.6)		Group E (acc. item A.7.1.5.6)		Group F (acc. item A.7.1.5.6)	
18. Operator Type	2" - 3"	Lever	2" - 3"	Lever	2" - 3"	Lever	2" - 3"	Lever
	4" - 20"	Gearbox	4" - 20"	Gearbox	4" - 20"	Gearbox	4" - 20"	Gearbox
19. Additional Requirement	N/A		N/A		N/A		N/A	
20. Seat Type	Side A: SPE / Side B: DPE; DIB-2 & DBB		Side A: SPE / Side B: SPE		Side A: SPE / Side B: DPE; DIB-2 & DBB		Side A: SPE / Side B: SPE	
21. Bore Type	Full Bore		Full Bore		Full Bore		Full Bore	
22. Body Construction	split body, bolted		split body, bolted		split body, bolted		split body, bolted	
23. Cladding or Coating	Partial clad - Inconel 625 weld overlay on all body sealing areas		Partial clad - Inconel 625 weld overlay on all body sealing areas		Partial clad - Inconel 625 weld overlay on all body sealing areas		Partial clad - Inconel 625 weld overlay on all body sealing areas	
24. Valve Testing	FAT according A.9.3		FAT according A.9.3		FAT according A.9.3		FAT according A.9.3	
25. Notes	Acceptance criteria for sealing tests see Annex A		N/A		Acceptance criteria for sealing tests see Annex A		N/A	

Valve Code	VES-900-2-C282		VES-900-2-S214		VES-900-2-S218		VES-900-2-S224	
Specs	F6		F3		F3		F3	
1. Valve Type	Ball		Ball		Ball		Ball	
2. Sealing Type	Metal to Metal		Soft		Soft		Soft	
3. Valve Specification Level (VSL)	VSL-2		VSL-2		VSL-2		VSL-2	
4. Ball Mouting	Trunnion		Trunnion		Trunnion		Trunnion	
5. Standard	API 6D		API 6D / IOGP S-562		API 6D / IOGP S-562		API 6D / IOGP S-562	
6. Size Range (NPS)	2" - 20"		2" - 18"		2" - 18"		2" - 18"	
7. End Connection	ASME B16.5, RTJ		ASME B16.5, RTJ		ASME B16.5, RTJ		ASME B16.5, RTJ	
8. Pressure Class	900		900		900		900	
9. Temperature	-46°C to 340°C		-30°C to 150°C		-30°C to 150°C		0°C to 150°C	
10. Material Class	Carbon Steel		Stainless Steel		Stainless Steel		Stainless Steel	
11. Body Material	ASTM A350 Gr LF2 CL1 or ASTM A352 Gr LCB + Inconel 625 weld overlay (acc. item A.7.1.7.3)		ASTM A182 Gr F316 or ASTM A351 Gr CF8M		ASTM A182 Gr F316 or ASTM A351 Gr CF8M		ASTM A182 Gr F316 or ASTM A351 Gr CF8M	
12. Obturator Material	AISI 316 + Chrome-Nickel Spray and Fuse (acc. Item A.8.2.2.4)		AISI 316		AISI 316		AISI 316	
13. Seat Material	AISI 316 + Chrome-Nickel Spray and Fuse (acc. Item A.8.2.2.4)		AISI 316		AISI 316		AISI 316	
14. Seat Insert	N/A		PEEK		PEEK		PEEK	
15. Spring (Seat) Material	UNS N07750		UNS N07750		UNS N07750		UNS N07750	
16. Stem Material	ASTM A276 (UNS S31600)		ASTM A276 (UNS S31600)		ASTM A276 (UNS S31600)		ASTM A276 (UNS S31600)	
17. Seat-Stem Seal	Group F (acc. item A.7.1.5.6)		Group B (acc. item A.7.1.5.6)		Group B (acc. item A.7.1.5.6)		Group C (acc. item A.7.1.5.6)	
18. Operator Type	2" - 3"	Lever	2" - 3"	Lever	2" - 3"	Lever	2" - 3"	Lever
	4" - 20"	Gearbox	4" - 18"	Gearbox	4" - 18"	Gearbox	4" - 18"	Gearbox
19. Additional Requirement	N/A		N/A		N/A		N/A	
20. Seat Type	Side A: SPE / Side B: DPE; DIB-2 & DBB		Side A: SPE / Side B: SPE; DBB		Side A: SPE / Side B: DPE; DIB-2 & DBB		Side A: SPE / Side B: SPE; DBB	
21. Bore Type	Full Bore		Full Bore		Full Bore		Full Bore	
22. Body Construction	split body, bolted		split body, bolted		split body, bolted		split body, bolted	
23. Cladding or Coating	Partial clad - Inconel 625 weld overlay on all body sealing areas		N/A		N/A		N/A	
24. Valve Testing	FAT according A.9.3		FAT according A.9.3		FAT according A.9.3		FAT according A.9.3	
25. Notes	N/A		N/A		N/A		N/A	

Valve Code	VES-900-2-S228		VES-900-2-S234		VES-900-2-S238		VES-900-2-S250	
Specs	F3		F3		F3		F3	
1. Valve Type	Ball		Ball		Ball		Ball	
2. Sealing Type	Soft		Soft		Soft		Metal to Metal	
3. Valve Specification Level (VSL)	VSL-2		VSL-2		VSL-2		VSL-2	
4. Ball Mouting	Trunnion		Trunnion		Trunnion		Trunnion	
5. Standard	API 6D / IOGP S-562		API 6D / IOGP S-562		API 6D / IOGP S-562		API 6D / IOGP S-562	
6. Size Range (NPS)	2" - 18"		2" - 18"		2" - 18"		2" - 18"	
7. End Connection	ASME B16.5, RTJ		ASME B16.5, RTJ		ASME B16.5, RTJ		ASME B16.5, RTJ	
8. Pressure Class	900		900		900		900	
9. Temperature	0°C to 150°C		-46°C to 150°C		-46°C to 150°C		-30°C to 150°C	
10. Material Class	Stainless Steel		Stainless Steel		Stainless Steel		Stainless Steel	
11. Body Material	ASTM A182 Gr F316 or ASTM A351 Gr CF8M		ASTM A182 Gr F316 or ASTM A351 Gr CF8M		ASTM A182 Gr F316 or ASTM A351 Gr CF8M		ASTM A182 Gr F316 or ASTM A351 Gr CF8M	
12. Obturator Material	AISI 316		AISI 316		AISI 316		AISI 316 + Tungsten carbide coating	
13. Seat Material	AISI 316		AISI 316		AISI 316		AISI 316 + Tungsten carbide coating	
14. Seat Insert	PEEK		PEEK		PEEK		N/A	
15. Spring (Seat) Material	UNS N07750		UNS N07750		UNS N07750		UNS N07750	
16. Stem Material	ASTM A276 (UNS S31600)		ASTM A276 (UNS S31600)		ASTM A276 (UNS S31600)		ASTM A276 (UNS S31803)	
17. Seat-Stem Seal	Group C (acc. item A.7.1.5.6)		Group E (acc. item A.7.1.5.6)		Group E (acc. item A.7.1.5.6)		Group B (acc. item A.7.1.5.6)	
18. Operator Type	2" - 3"	Lever	2" - 3"	Lever	2" - 3"	Lever	2" - 3"	Lever
	4" - 18"	Gearbox	4" - 18"	Gearbox	4" - 18"	Gearbox	4" - 18"	Gearbox
19. Additional Requirement	N/A		N/A		N/A		N/A	
20. Seat Type	Side A: SPE / Side B: DPE; DIB-2 & DBB		Side A: SPE / Side B: SPE; DBB		Side A: SPE / Side B: DPE; DIB-2 & DBB		Side A: SPE / Side B: SPE	
21. Bore Type	Full Bore		Full Bore		Full Bore		Full Bore	
22. Body Construction	split body, bolted		split body, bolted		split body, bolted		split body, bolted	
23. Cladding or Coating	N/A		N/A		N/A		N/A	
24. Valve Testing	FAT according A.9.3		FAT according A.9.3		FAT according A.9.3		FAT according A.9.3	
25. Notes	N/A		N/A		N/A		N/A	

Valve Code	VES-900-2-S252		VES-900-2-S260		VES-900-2-S262		VES-900-2-S270	
Specs	F3		F3		F3		F3	
1. Valve Type	Ball		Ball		Ball		Ball	
2. Sealing Type	Metal to Metal		Metal to Metal		Metal to Metal		Metal to Metal	
3. Valve Specification Level (VSL)	VSL-2		VSL-2		VSL-2		VSL-2	
4. Ball Mouting	Trunnion		Trunnion		Trunnion		Trunnion	
5. Standard	API 6D / IOGP S-562		API 6D		API 6D		API 6D	
6. Size Range (NPS)	2" - 18"		2" - 18"		2" - 18"		2" - 18"	
7. End Connection	ASME B16.5, RTJ		ASME B16.5, RTJ		ASME B16.5, RTJ		ASME B16.5, RTJ	
8. Pressure Class	900		900		900		900	
9. Temperature	-30°C to 150°C		0°C to 210°C		0°C to 210°C		-100°C to 200°C	
10. Material Class	Stainless Steel		Stainless Steel		Stainless Steel		Stainless Steel	
11. Body Material	ASTM A182 Gr F316 or ASTM A351 Gr CF8M		ASTM A182 Gr F316 or ASTM A351 Gr CF8M		ASTM A182 Gr F316 or ASTM A351 Gr CF8M		ASTM A182 Gr F316 or ASTM A351 Gr CF8M	
12. Obturator Material	AISI 316 + Tungsten carbide coating		AISI 316 + Tungsten carbide coating		AISI 316 + Tungsten carbide coating		AISI 316 + Tungsten carbide coating	
13. Seat Material	AISI 316 + Tungsten carbide coating		AISI 316 + Tungsten carbide coating		AISI 316 + Tungsten carbide coating		AISI 316 + Tungsten carbide coating	
14. Seat Insert	N/A		N/A		N/A		N/A	
15. Spring (Seat) Material	UNS N07750		UNS N07750		UNS N07750		UNS N07750	
16. Stem Material	ASTM A276 (UNS S31803)		ASTM A276 (UNS S31803)		ASTM A276 (UNS S31803)		ASTM B637 (UNS N07718)	
17. Seat-Stem Seal	Group B (acc. item A.7.1.5.6)		Group C (acc. item A.7.1.5.6)		Group C (acc. item A.7.1.5.6)		Group E (acc. item A.7.1.5.6)	
18. Operator Type	2" - 3"	Lever	2" - 3"	Lever	2" - 3"	Lever	2" - 3"	Lever
	4" - 18"	Gearbox	4" - 18"	Gearbox	4" - 18"	Gearbox	4" - 18"	Gearbox
19. Additional Requirement	N/A		N/A		N/A		N/A	
20. Seat Type	Side A: SPE / Side B: DPE; DIB-2 & DBB		Side A: SPE / Side B: SPE		Side A: SPE / Side B: DPE; DIB-2 & DBB		Side A: SPE / Side B: SPE	
21. Bore Type	Full Bore		Full Bore		Full Bore		Full Bore	
22. Body Construction	split body, bolted		split body, bolted		split body, bolted		split body, bolted	
23. Cladding or Coating	N/A		N/A		N/A		N/A	
24. Valve Testing	FAT according A.9.3		FAT according A.9.3		FAT according A.9.3		FAT according A.9.3	
25. Notes	N/A		N/A		N/A		N/A	

Valve Code	VES-900-2-S272		VES-900-3-C118		VES-900-3-C119		VES-900-3-C138	
Specs	F3		F10		F10		F10	
1. Valve Type	Ball		Ball		Ball		Ball	
2. Sealing Type	Metal to Metal		Soft		Soft		Soft	
3. Valve Specification Level (VSL)	VSL-2		VSL-3		VSL-3		VSL-3	
4. Ball Mouting	Trunnion		Trunnion		Trunnion		Trunnion	
5. Standard	API 6D		API 6D / IOGP S-562		API 6D / IOGP S-562		API 6D / IOGP S-562	
6. Size Range (NPS)	2" - 18"		2" - 24"		2" - 24"		2" - 24"	
7. End Connection	ASME B16.5, RTJ		ASME B16.5, RTJ		ASME B16.5, RTJ		ASME B16.5, RTJ	
8. Pressure Class	900		900		900		900	
9. Temperature	-100°C to 200°C		-29°C to 150°C		-29°C to 150°C		0°C to 150°C	
10. Material Class	Stainless Steel		Carbon Steel		Carbon Steel		Carbon Steel	
11. Body Material	ASTM A182 Gr F316 or ASTM A351 Gr CF8M		ASTM A105 + SS316 weld overlay (acc. item A.7.1.7.3)		ASTM A105 + SS316 weld overlay (acc. item A.7.1.7.3)		ASTM A105 + SS316 weld overlay (acc. item A.7.1.7.3)	
12. Obturator Material	AISI 316 + Tungsten carbide coating		AISI 410		AISI 410		AISI 410	
13. Seat Material	AISI 316 + Tungsten carbide coating		AISI 410		AISI 410		AISI 410	
14. Seat Insert	N/A		PEEK		PEEK		PEEK	
15. Spring (Seat) Material	UNS N07750		UNS N07750		UNS N07750		UNS N07750	
16. Stem Material	ASTM B637 (UNS N07718)		ASTM A276 (UNS S41000)		ASTM A276 (UNS S41000)		ASTM A276 (UNS S41000)	
17. Seat-Stem Seal	Group E (acc. item A.7.1.5.6)		Group B (acc. item A.7.1.5.6)		Group B (acc. item A.7.1.5.6)		Group D (acc. item A.7.1.5.6)	
18. Operator Type	2" - 3"	Lever	2" - 3"	Lever	2" - 3"	Lever	2" - 3"	Lever
	4" - 18"	Gearbox	4" - 24"	Gearbox	4" - 24"	Gearbox	4" - 24"	Gearbox
19. Additional Requirement	N/A		N/A		Fire Tested (acc. item A.6.1.4)		N/A	
20. Seat Type	Side A: SPE / Side B: DPE; DIB-2 & DBB		Side A: SPE / Side B: DPE; DIB-2 & DBB		Side A: SPE / Side B: DPE; DIB-2 & DBB		Side A: SPE / Side B: DPE; DIB-2 & DBB	
21. Bore Type	Full Bore		Full Bore		Full Bore		Full Bore	
22. Body Construction	split body, bolted		split body, bolted		split body, bolted		split body, bolted	
23. Cladding or Coating	N/A		Partial clad - SS316 weld overlay on all body sealing areas		Partial clad - SS316 weld overlay on all body sealing areas		Partial clad - SS316 weld overlay on all body sealing areas	
24. Valve Testing	FAT according A.9.3		FAT according A.9.3		FAT according A.9.3		FAT according A.9.3	
25. Notes	N/A		N/A		N/A		N/A	

Valve Code	VES-900-3-C139		VES-900-3-C152		VES-900-3-C153		VES-900-3-C162	
Specs	F10		F10		F10		F10	
1. Valve Type	Ball		Ball		Ball		Ball	
2. Sealing Type	Soft		Metal to Metal		Metal to Metal		Metal to Metal	
3. Valve Specification Level (VSL)	VSL-3		VSL-3		VSL-3		VSL-3	
4. Ball Mouting	Trunnion		Trunnion		Trunnion		Trunnion	
5. Standard	API 6D / IOGP S-562		API 6D / IOGP S-562		API 6D / IOGP S-562		API 6D	
6. Size Range (NPS)	2" - 24"		2" - 24"		2" - 24"		2" - 24"	
7. End Connection	ASME B16.5, RTJ		ASME B16.5, RTJ		ASME B16.5, RTJ		ASME B16.5, RTJ	
8. Pressure Class	900		900		900		900	
9. Temperature	-29°C to 150°C		0°C to 150°C		-29°C to 150°C		0°C to 210°C	
10. Material Class	Carbon Steel		Carbon Steel		Carbon Steel		Carbon Steel	
11. Body Material	ASTM A105 + SS316 weld overlay (acc. item A.7.1.7.3)		ASTM A105 + SS316 weld overlay (acc. item A.7.1.7.3)		ASTM A105 + SS316 weld overlay (acc. item A.7.1.7.3)		ASTM A105 + SS316 weld overlay (acc. item A.7.1.7.3)	
12. Obturator Material	AISI 410		AISI 410 + Tungsten carbide coating		AISI 410 + Tungsten carbide coating		AISI 410 + Tungsten carbide coating	
13. Seat Material	AISI 410		AISI 410 + Tungsten carbide coating		AISI 410 + Tungsten carbide coating		AISI 410 + Tungsten carbide coating	
14. Seat Insert	PEEK		N/A		N/A		N/A	
15. Spring (Seat) Material	UNS N07750		UNS N07750		UNS N07750		UNS N07750	
16. Stem Material	ASTM A276 (UNS S41000)		ASTM A276 (UNS S41000)		ASTM A276 (UNS S41000)		ASTM A276 (UNS S41000)	
17. Seat-Stem Seal	Group E (acc. item A.7.1.5.6)		Group A (acc. item A.7.1.5.6)		Group B (acc. item A.7.1.5.6)		Group C (acc. item A.7.1.5.6)	
18. Operator Type	2" - 3"	Lever	2" - 3"	Lever	2" - 3"	Lever	2" - 3"	Lever
	4" - 24"	Gearbox	4" - 24"	Gearbox	4" - 24"	Gearbox	4" - 24"	Gearbox
19. Additional Requirement	Fire Tested (acc. item A.6.1.4)		N/A		Fire Tested (acc. item A.6.1.4)		N/A	
20. Seat Type	Side A: SPE / Side B: DPE; DIB-2 & DBB		Side A: SPE / Side B: DPE; DIB-2 & DBB		Side A: SPE / Side B: DPE; DIB-2 & DBB		Side A: SPE / Side B: DPE; DIB-2 & DBB	
21. Bore Type	Full Bore		Full Bore		Full Bore		Full Bore	
22. Body Construction	split body, bolted		split body, bolted		split body, bolted		split body, bolted	
23. Cladding or Coating	Partial clad - SS316 weld overlay on all body sealing areas		Partial clad - SS316 weld overlay on all body sealing areas		Partial clad - SS316 weld overlay on all body sealing areas		Partial clad - SS316 weld overlay on all body sealing areas	
24. Valve Testing	FAT according A.9.3		FAT according A.9.3		FAT according A.9.3		FAT according A.9.3	
25. Notes	N/A		Acceptance criteria for sealing tests see Annex A		Acceptance criteria for sealing tests see Annex A		Acceptance criteria for sealing tests see Annex A	

Valve Code	VES-900-3-C163		VES-900-3-C172		VES-900-3-C173		VES-900-3-C218	
Specs	F10		F10		F10		F6	
1. Valve Type	Ball		Ball		Ball		Ball	
2. Sealing Type	Metal to Metal		Metal to Metal		Metal to Metal		Soft	
3. Valve Specification Level (VSL)	VSL-3		VSL-3		VSL-3		VSL-3	
4. Ball Mouting	Trunnion		Trunnion		Trunnion		Trunnion	
5. Standard	API 6D		API 6D		API 6D		API 6D / IOGP S-562	
6. Size Range (NPS)	2" - 24"		2" - 24"		2" - 24"		2" - 20"	
7. End Connection	ASME B16.5, RTJ		ASME B16.5, RTJ		ASME B16.5, RTJ		ASME B16.5, RTJ	
8. Pressure Class	900		900		900		900	
9. Temperature	0°C to 210°C		0°C to 210°C		-29°C to 200°C		-30°C to 150°C	
10. Material Class	Carbon Steel		Carbon Steel		Carbon Steel		Carbon Steel	
11. Body Material	ASTM A105 + SS316 weld overlay (acc. item A.7.1.7.3)		ASTM A105 + SS316 weld overlay (acc. item A.7.1.7.3)		ASTM A105 + SS316 weld overlay (acc. item A.7.1.7.3)		ASTM A350 Gr LF2 CL1 + Inconel 625 weld overlay (acc. item A.7.1.7.3)	
12. Obturator Material	AISI 410 + Tungsten carbide coating		AISI 410 + Tungsten carbide coating		AISI 410 + Tungsten carbide coating		AISI 316	
13. Seat Material	AISI 410 + Tungsten carbide coating		AISI 410 + Tungsten carbide coating		AISI 410 + Tungsten carbide coating		AISI 316	
14. Seat Insert	N/A		N/A		N/A		PEEK	
15. Spring (Seat) Material	UNS N07750		UNS N07750		UNS N07750		UNS N07750	
16. Stem Material	ASTM A276 (UNS S41000)		ASTM A276 (UNS S41000)		ASTM A276 (UNS S41000)		ASTM A276 (UNS S31600)	
17. Seat-Stem Seal	Group C (acc. item A.7.1.5.6)		Group D (acc. item A.7.1.5.6)		Group E (acc. item A.7.1.5.6)		Group B (acc. item A.7.1.5.6)	
18. Operator Type	2" - 3"	Lever	2" - 3"	Lever	2" - 3"	Lever	2" - 3"	Lever
	4" - 24"	Gearbox	4" - 24"	Gearbox	4" - 24"	Gearbox	4" - 20"	Gearbox
19. Additional Requirement	Fire Tested (acc. item A.6.1.4)		N/A		Fire Tested (acc. item A.6.1.4)		N/A	
20. Seat Type	Side A: SPE / Side B: DPE; DIB-2 & DBB		Side A: SPE / Side B: DPE; DIB-2 & DBB		Side A: SPE / Side B: DPE; DIB-2 & DBB		Side A: SPE / Side B: DPE; DIB-2 & DBB	
21. Bore Type	Full Bore		Full Bore		Full Bore		Full Bore	
22. Body Construction	split body, bolted		split body, bolted		split body, bolted		split body, bolted	
23. Cladding or Coating	Partial clad - SS316 weld overlay on all body sealing areas		Partial clad - SS316 weld overlay on all body sealing areas		Partial clad - SS316 weld overlay on all body sealing areas		Partial clad - Inconel 625 weld overlay on all body sealing areas	
24. Valve Testing	FAT according A.9.3		FAT according A.9.3		FAT according A.9.3		FAT according A.9.3	
25. Notes	Acceptance criteria for sealing tests see Annex A		Acceptance criteria for sealing tests see Annex A		Acceptance criteria for sealing tests see Annex A		N/A	

Valve Code	VES-900-3-C219		VES-900-3-C238		VES-900-3-C239		VES-900-3-C252	
Specs	F6		F6		F6		F6	
1. Valve Type	Ball		Ball		Ball		Ball	
2. Sealing Type	Soft		Soft		Soft		Metal to Metal	
3. Valve Specification Level (VSL)	VSL-3		VSL-3		VSL-3		VSL-3	
4. Ball Mouting	Trunnion		Trunnion		Trunnion		Trunnion	
5. Standard	API 6D / IOGP S-562		API 6D / IOGP S-562		API 6D / IOGP S-562		API 6D / IOGP S-562	
6. Size Range (NPS)	2" - 20"		2" - 20"		2" - 20"		2" - 20"	
7. End Connection	ASME B16.5, RTJ		ASME B16.5, RTJ		ASME B16.5, RTJ		ASME B16.5, RTJ	
8. Pressure Class	900		900		900		900	
9. Temperature	-30°C to 150°C		-46°C to 150°C		-46°C to 150°C		-30°C to 150°C	
10. Material Class	Carbon Steel		Carbon Steel		Carbon Steel		Carbon Steel	
11. Body Material	ASTM A350 Gr LF2 CL1 + Inconel 625 weld overlay (acc. item A.7.1.7.3)		ASTM A350 Gr LF2 CL1 + Inconel 625 weld overlay (acc. item A.7.1.7.3)		ASTM A350 Gr LF2 CL1 + Inconel 625 weld overlay (acc. item A.7.1.7.3)		ASTM A350 Gr LF2 CL1 + Inconel 625 weld overlay (acc. item A.7.1.7.3)	
12. Obturator Material	AISI 316		AISI 316		AISI 316		AISI 316 + Tungsten carbide coating	
13. Seat Material	AISI 316		AISI 316		AISI 316		AISI 316 + Tungsten carbide coating	
14. Seat Insert	PEEK		PEEK		PEEK		N/A	
15. Spring (Seat) Material	UNS N07750		UNS N07750		UNS N07750		UNS N07750	
16. Stem Material	ASTM A276 (UNS S31600)		ASTM A276 (UNS S31600)		ASTM A276 (UNS S31600)		ASTM A276 (UNS S31600)	
17. Seat-Stem Seal	Group B (acc. item A.7.1.5.6)		Group E (acc. item A.7.1.5.6)		Group E (acc. item A.7.1.5.6)		Group B (acc. item A.7.1.5.6)	
18. Operator Type	2" - 3"	Lever	2" - 3"	Lever	2" - 3"	Lever	2" - 3"	Lever
	4" - 20"	Gearbox	4" - 20"	Gearbox	4" - 20"	Gearbox	4" - 20"	Gearbox
19. Additional Requirement	Fire Tested (acc. item A.6.1.4)		N/A		Fire Tested (acc. item A.6.1.4)		N/A	
20. Seat Type	Side A: SPE / Side B: DPE; DIB-2 & DBB		Side A: SPE / Side B: DPE; DIB-2 & DBB		Side A: SPE / Side B: DPE; DIB-2 & DBB		Side A: SPE / Side B: DPE; DIB-2 & DBB	
21. Bore Type	Full Bore		Full Bore		Full Bore		Full Bore	
22. Body Construction	split body, bolted		split body, bolted		split body, bolted		split body, bolted	
23. Cladding or Coating	Partial clad - Inconel 625 weld overlay on all body sealing areas		Partial clad - Inconel 625 weld overlay on all body sealing areas		Partial clad - Inconel 625 weld overlay on all body sealing areas		Partial clad - Inconel 625 weld overlay on all body sealing areas	
24. Valve Testing	FAT according A.9.3		FAT according A.9.3		FAT according A.9.3		FAT according A.9.3	
25. Notes	N/A		N/A		N/A		Acceptance criteria for sealing tests see Annex A	

Valve Code	VES-900-3-C253		VES-900-3-C272		VES-900-3-C273		VES-900-3-C283	
Specs	F6		F6		F6		F6	
1. Valve Type	Ball		Ball		Ball		Ball	
2. Sealing Type	Metal to Metal		Metal to Metal		Metal to Metal		Metal to Metal	
3. Valve Specification Level (VSL)	VSL-3		VSL-3		VSL-3		VSL-3	
4. Ball Mouting	Trunnion		Trunnion		Trunnion		Trunnion	
5. Standard	API 6D / IOGP S-562		API 6D		API 6D		API 6D	
6. Size Range (NPS)	2" - 20"		2" - 20"		2" - 20"		2" - 20"	
7. End Connection	ASME B16.5, RTJ		ASME B16.5, RTJ		ASME B16.5, RTJ		ASME B16.5, RTJ	
8. Pressure Class	900		900		900		900	
9. Temperature	-30°C to 150°C		-46°C to 200°C		-46°C to 200°C		-46°C to 340°C	
10. Material Class	Carbon Steel		Carbon Steel		Carbon Steel		Carbon Steel	
11. Body Material	ASTM A350 Gr LF2 CL1 + Inconel 625 weld overlay (acc. item A.7.1.7.3)		ASTM A350 Gr LF2 CL1 + Inconel 625 weld overlay (acc. item A.7.1.7.3)		ASTM A350 Gr LF2 CL1 + Inconel 625 weld overlay (acc. item A.7.1.7.3)		ASTM A350 Gr LF2 CL1 or ASTM A352 Gr LCB + Inconel 625 weld overlay (acc. item A.7.1.7.3)	
12. Obturator Material	AISI 316 + Tungsten carbide coating		AISI 316 + Tungsten carbide coating		AISI 316 + Tungsten carbide coating		AISI 316 + Chrome-Nickel Spray and Fuse (acc. Item A.8.2.2.4)	
13. Seat Material	AISI 316 + Tungsten carbide coating		AISI 316 + Tungsten carbide coating		AISI 316 + Tungsten carbide coating		AISI 316 + Chrome-Nickel Spray and Fuse (acc. Item A.8.2.2.4)	
14. Seat Insert	N/A		N/A		N/A		N/A	
15. Spring (Seat) Material	UNS N07750		UNS N07750		UNS N07750		UNS N07750	
16. Stem Material	ASTM A276 (UNS S31600)		ASTM A276 (UNS S31600)		ASTM A276 (UNS S31600)		ASTM A276 (UNS S31600)	
17. Seat-Stem Seal	Group B (acc. item A.7.1.5.6)		Group E (acc. item A.7.1.5.6)		Group E (acc. item A.7.1.5.6)		Group F (acc. item A.7.1.5.6)	
18. Operator Type	2" - 3"	Lever	2" - 3"	Lever	2" - 3"	Lever	2" - 3"	Lever
	4" - 20"	Gearbox	4" - 20"	Gearbox	4" - 20"	Gearbox	4" - 20"	Gearbox
19. Additional Requirement	Fire Tested (acc. item A.6.1.4)		N/A		Fire Tested (acc. item A.6.1.4)		Fire Tested (acc. item A.6.1.4)	
20. Seat Type	Side A: SPE / Side B: DPE; DIB-2 & DBB		Side A: SPE / Side B: DPE; DIB-2 & DBB		Side A: SPE / Side B: DPE; DIB-2 & DBB		Side A: SPE / Side B: DPE; DIB-2 & DBB	
21. Bore Type	Full Bore		Full Bore		Full Bore		Full Bore	
22. Body Construction	split body, bolted		split body, bolted		split body, bolted		split body, bolted	
23. Cladding or Coating	Partial clad - Inconel 625 weld overlay on all body sealing areas		Partial clad - Inconel 625 weld overlay on all body sealing areas		Partial clad - Inconel 625 weld overlay on all body sealing areas		Partial clad - Inconel 625 weld overlay on all body sealing areas	
24. Valve Testing	FAT according A.9.3		FAT according A.9.3		FAT according A.9.3		FAT according A.9.3	
25. Notes	Acceptance criteria for sealing tests see Annex A		Acceptance criteria for sealing tests see Annex A		Acceptance criteria for sealing tests see Annex A		N/A	

Valve Code	VES-900-3-S218		VES-900-3-S219		VES-900-3-S228		VES-900-3-S229	
Specs	F3		F3		F3		F3	
1. Valve Type	Ball		Ball		Ball		Ball	
2. Sealing Type	Soft		Soft		Soft		Soft	
3. Valve Specification Level (VSL)	VSL-3		VSL-3		VSL-3		VSL-3	
4. Ball Mouting	Trunnion		Trunnion		Trunnion		Trunnion	
5. Standard	API 6D / IOGP S-562		API 6D / IOGP S-562		API 6D / IOGP S-562		API 6D / IOGP S-562	
6. Size Range (NPS)	2" - 18"		2" - 18"		2" - 18"		2" - 18"	
7. End Connection	ASME B16.5, RTJ		ASME B16.5, RTJ		ASME B16.5, RTJ		ASME B16.5, RTJ	
8. Pressure Class	900		900		900		900	
9. Temperature	-30°C to 150°C		-30°C to 150°C		0°C to 150°C		0°C to 150°C	
10. Material Class	Stainless Steel		Stainless Steel		Stainless Steel		Stainless Steel	
11. Body Material	ASTM A182 Gr F316		ASTM A182 Gr F316		ASTM A182 Gr F316		ASTM A182 Gr F316	
12. Obturator Material	AISI 316		AISI 316		AISI 316		AISI 316	
13. Seat Material	AISI 316		AISI 316		AISI 316		AISI 316	
14. Seat Insert	PEEK		PEEK		PEEK		PEEK	
15. Spring (Seat) Material	UNS N07750		UNS N07750		UNS N07750		UNS N07750	
16. Stem Material	ASTM A276 (UNS S31600)		ASTM A276 (UNS S31600)		ASTM A276 (UNS S31600)		ASTM A276 (UNS S31600)	
17. Seat-Stem Seal	Group B (acc. item A.7.1.5.6)		Group B (acc. item A.7.1.5.6)		Group C (acc. item A.7.1.5.6)		Group C (acc. item A.7.1.5.6)	
18. Operator Type	2" - 3" 4" - 18"	Lever Gearbox	2" - 3" 4" - 18"	Lever Gearbox	2" - 3" 4" - 18"	Lever Gearbox	2" - 3" 4" - 18"	Lever Gearbox
19. Additional Requirement	N/A		Fire Tested (acc. item A.6.1.4)		N/A		Fire Tested (acc. item A.6.1.4)	
20. Seat Type	Side A: SPE / Side B: DPE; DIB-2 & DBB		Side A: SPE / Side B: DPE; DIB-2 & DBB		Side A: SPE / Side B: DPE; DIB-2 & DBB		Side A: SPE / Side B: DPE; DIB-2 & DBB	
21. Bore Type	Full Bore		Full Bore		Full Bore		Full Bore	
22. Body Construction	split body, bolted		split body, bolted		split body, bolted		split body, bolted	
23. Cladding or Coating	N/A		N/A		N/A		N/A	
24. Valve Testing	FAT according A.9.3		FAT according A.9.3		FAT according A.9.3		FAT according A.9.3	
25. Notes	N/A		N/A		N/A		N/A	

Valve Code	VES-900-3-S238		VES-900-3-S239		VES-900-3-S252		VES-900-3-S253	
Specs	F3		F3		F3		F3	
1. Valve Type	Ball		Ball		Ball		Ball	
2. Sealing Type	Soft		Soft		Metal to Metal		Metal to Metal	
3. Valve Specification Level (VSL)	VSL-3		VSL-3		VSL-3		VSL-3	
4. Ball Mouting	Trunnion		Trunnion		Trunnion		Trunnion	
5. Standard	API 6D / IOGP S-562		API 6D / IOGP S-562		API 6D / IOGP S-562		API 6D / IOGP S-562	
6. Size Range (NPS)	2" - 18"		2" - 18"		2" - 18"		2" - 18"	
7. End Connection	ASME B16.5, RTJ		ASME B16.5, RTJ		ASME B16.5, RTJ		ASME B16.5, RTJ	
8. Pressure Class	900		900		900		900	
9. Temperature	-46°C to 150°C		-46°C to 150°C		-30°C to 150°C		-30°C to 150°C	
10. Material Class	Stainless Steel		Stainless Steel		Stainless Steel		Stainless Steel	
11. Body Material	ASTM A182 Gr F316		ASTM A182 Gr F316		ASTM A182 Gr F316		ASTM A182 Gr F316	
12. Obturator Material	AISI 316		AISI 316		AISI 316 + Tungsten carbide coating		AISI 316 + Tungsten carbide coating	
13. Seat Material	AISI 316		AISI 316		AISI 316 + Tungsten carbide coating		AISI 316 + Tungsten carbide coating	
14. Seat Insert	PEEK		PEEK		N/A		N/A	
15. Spring (Seat) Material	UNS N07750		UNS N07750		UNS N07750		UNS N07750	
16. Stem Material	ASTM A276 (UNS S31600)		ASTM A276 (UNS S31600)		ASTM A276 (UNS S31803)		ASTM A276 (UNS S31803)	
17. Seat-Stem Seal	Group E (acc. item A.7.1.5.6)		Group E (acc. item A.7.1.5.6)		Group B (acc. item A.7.1.5.6)		Group B (acc. item A.7.1.5.6)	
18. Operator Type	2" - 3"	Lever	2" - 3"	Lever	2" - 3"	Lever	2" - 3"	Lever
	4" - 18"	Gearbox						
19. Additional Requirement	N/A		Fire Tested (acc. item A.6.1.4)		N/A		Fire Tested (acc. item A.6.1.4)	
20. Seat Type	Side A: SPE / Side B: DPE; DIB-2 & DBB		Side A: SPE / Side B: DPE; DIB-2 & DBB		Side A: SPE / Side B: DPE; DIB-2 & DBB		Side A: SPE / Side B: DPE; DIB-2 & DBB	
21. Bore Type	Full Bore		Full Bore		Full Bore		Full Bore	
22. Body Construction	split body, bolted		split body, bolted		split body, bolted		split body, bolted	
23. Cladding or Coating	N/A		N/A		N/A		N/A	
24. Valve Testing	FAT according A.9.3		FAT according A.9.3		FAT according A.9.3		FAT according A.9.3	
25. Notes	N/A		N/A		Acceptance criteria for sealing tests see Annex A		Acceptance criteria for sealing tests see Annex A	

Valve Code	VES-900-3-S262		VES-900-3-S263		VES-900-3-S272		VES-900-3-S273	
Specs	F3		F3		F3		F3	
1. Valve Type	Ball		Ball		Ball		Ball	
2. Sealing Type	Metal to Metal		Metal to Metal		Metal to Metal		Metal to Metal	
3. Valve Specification Level (VSL)	VSL-3		VSL-3		VSL-3		VSL-3	
4. Ball Mouting	Trunnion		Trunnion		Trunnion		Trunnion	
5. Standard	API 6D		API 6D		API 6D		API 6D	
6. Size Range (NPS)	2" - 18"		2" - 18"		2" - 18"		2" - 18"	
7. End Connection	ASME B16.5, RTJ		ASME B16.5, RTJ		ASME B16.5, RTJ		ASME B16.5, RTJ	
8. Pressure Class	900		900		900		900	
9. Temperature	0°C to 210°C		0°C to 210°C		-46°C to 200°C		-100°C to 200°C	
10. Material Class	Stainless Steel		Stainless Steel		Stainless Steel		Stainless Steel	
11. Body Material	ASTM A182 Gr F316		ASTM A182 Gr F316		ASTM A182 Gr F316		ASTM A182 Gr F316	
12. Obturator Material	AISI 316 + Tungsten carbide coating		AISI 316 + Tungsten carbide coating		AISI 316 + Tungsten carbide coating		AISI 316 + Tungsten carbide coating	
13. Seat Material	AISI 316 + Tungsten carbide coating		AISI 316 + Tungsten carbide coating		AISI 316 + Tungsten carbide coating		AISI 316 + Tungsten carbide coating	
14. Seat Insert	N/A		N/A		N/A		N/A	
15. Spring (Seat) Material	UNS N07750		UNS N07750		UNS N07750		UNS N07750	
16. Stem Material	ASTM A276 (UNS S31803)		ASTM A276 (UNS S31803)		ASTM A276 (UNS S31803)		ASTM B637 (UNS N07718)	
17. Seat-Stem Seal	Group C (acc. item A.7.1.5.6)		Group C (acc. item A.7.1.5.6)		Group E (acc. item A.7.1.5.6)		Group E (acc. item A.7.1.5.6)	
18. Operator Type	2" - 3"	Lever	2" - 3"	Lever	2" - 3"	Lever	2" - 3"	Lever
	4" - 18"	Gearbox						
19. Additional Requirement	N/A		Fire Tested (acc. item A.6.1.4)		N/A		Fire Tested (acc. item A.6.1.4)	
20. Seat Type	Side A: SPE / Side B: DPE; DIB-2 & DBB		Side A: SPE / Side B: DPE; DIB-2 & DBB		Side A: SPE / Side B: DPE; DIB-2 & DBB		Side A: SPE / Side B: DPE; DIB-2 & DBB	
21. Bore Type	Full Bore		Full Bore		Full Bore		Full Bore	
22. Body Construction	split body, bolted		split body, bolted		split body, bolted		split body, bolted	
23. Cladding or Coating	N/A		N/A		N/A		N/A	
24. Valve Testing	FAT according A.9.3		FAT according A.9.3		FAT according A.9.3		FAT according A.9.3	
25. Notes	Acceptance criteria for sealing tests see Annex A		Acceptance criteria for sealing tests see Annex A		Acceptance criteria for sealing tests see Annex A		Acceptance criteria for sealing tests see Annex A	

Valve Code	VES-900-4-C154	VES-900-4-C164	VES-900-4-C174	VES-900-4-S254
Specs	F10	F10	F10	F3
1. Valve Type	Ball	Ball	Ball	Ball
2. Sealing Type	Metal to Metal	Metal to Metal	Metal to Metal	Metal to Metal
3. Valve Specification Level (VSL)	VSL-4	VSL-4	VSL-4	VSL-4
4. Ball Mouting	Trunnion	Trunnion	Trunnion	Trunnion
5. Standard	API 6D / IOGP S-562	API 6D	API 6D	API 6D / IOGP S-562
6. Size Range (NPS)	6" - 24"	6" - 24"	6" - 24"	6" - 18"
7. End Connection	ASME B16.5, RTJ	ASME B16.5, RTJ	ASME B16.5, RTJ	ASME B16.5, RTJ
8. Pressure Class	900	900	900	900
9. Temperature	-29°C to 150°C	0°C to 210°C	-29°C to 200°C	-30°C to 150°C
10. Material Class	Carbon Steel	Carbon Steel	Carbon Steel	Stainless Steel
11. Body Material	ASTM A105 + SS316 weld overlay (acc. item A.7.1.7.3)	ASTM A105 + SS316 weld overlay (acc. item A.7.1.7.3)	ASTM A105 + SS316 weld overlay (acc. item A.7.1.7.3)	ASTM A182 Gr F316
12. Obturator Material	AISI 410 + Tungsten carbide coating	AISI 410 + Tungsten carbide coating	AISI 410 + Tungsten carbide coating	AISI 316 + Tungsten carbide coating
13. Seat Material	AISI 410 + Tungsten carbide coating	AISI 410 + Tungsten carbide coating	AISI 410 + Tungsten carbide coating	AISI 316 + Tungsten carbide coating
14. Seat Insert	N/A	N/A	N/A	N/A
15. Spring (Seat) Material	UNS N07750	UNS N07750	UNS N07750	UNS N07750
16. Stem Material	ASTM A276 (UNS S41000)	ASTM A276 (UNS S41000)	ASTM A276 (UNS S41000)	ASTM A276 (UNS S31803)
17. Seat-Stem Seal	Group B (acc. item A.7.1.5.6)	Group C (acc. item A.7.1.5.6)	Group E (acc. item A.7.1.5.6)	Group B (acc. item A.7.1.5.6)
18. Operator Type	Actuated	Actuated	Actuated	Actuated
19. Additional Requirement	Fire Tested (acc. item A.6.1.4)	Fire Tested (acc. item A.6.1.4)	Fire Tested (acc. item A.6.1.4)	Fire Tested (acc. item A.6.1.4)
20. Seat Type	Side A: SPE / Side B: DPE; DIB-2 & DBB (notes)	Side A: SPE / Side B: DPE; DIB-2 & DBB (notes)	Side A: SPE / Side B: DPE; DIB-2 & DBB (notes)	Side A: SPE / Side B: DPE; DIB-2 & DBB (notes)
21. Bore Type	Full Bore	Full Bore	Full Bore	Full Bore
22. Body Construction	split body, bolted	split body, bolted	split body, bolted	split body, bolted
23. Cladding or Coating	Partial clad - SS316 weld overlay on all body sealing areas	Partial clad - SS316 weld overlay on all body sealing areas	Partial clad - SS316 weld overlay on all body sealing areas	N/A
24. Valve Testing	FAT according A.9.3	FAT according A.9.3	FAT according A.9.3	FAT according A.9.3
25. Notes	Acceptance criteria for sealing tests see Annex A, DBB tests to be performed at both conditions, fully opened and closed, Vent and drain connections according Annex A	Acceptance criteria for sealing tests see Annex A, DBB tests to be performed at both conditions, fully opened and closed, Vent and drain connections according Annex A	Acceptance criteria for sealing tests see Annex A, DBB tests to be performed at both conditions, fully opened and closed, Vent and drain connections according Annex A	Acceptance criteria for sealing tests see Annex A, DBB tests to be performed at both conditions, fully opened and closed, Vent and drain connections according Annex A

Valve Code	VES-900-4-S264	VES-900-4-S274
Specs	F3	F3
1. Valve Type	Ball	Ball
2. Sealing Type	Metal to Metal	Metal to Metal
3. Valve Specification Level (VSL)	VSL-4	VSL-4
4. Ball Mouting	Trunnion	Trunnion
5. Standard	API 6D	API 6D
6. Size Range (NPS)	6" - 18"	6" - 18"
7. End Connection	ASME B16.5, RTJ	ASME B16.5, RTJ
8. Pressure Class	900	900
9. Temperature	0°C to 210°C	-46°C to 200°C
10. Material Class	Stainless Steel	Stainless Steel
11. Body Material	ASTM A182 Gr F316	ASTM A182 Gr F316
12. Obturator Material	AISI 316 + Tungsten carbide coating	AISI 316 + Tungsten carbide coating
13. Seat Material	AISI 316 + Tungsten carbide coating	AISI 316 + Tungsten carbide coating
14. Seat Insert	N/A	N/A
15. Spring (Seat) Material	UNS N07750	UNS N07750
16. Stem Material	ASTM A276 (UNS S31803)	ASTM A276 (UNS S31803)
17. Seat-Stem Seal	Group C (acc. item A.7.1.5.6)	Group E (acc. item A.7.1.5.6)
18. Operator Type	Actuated	Actuated
19. Additional Requirement	Fire Tested (acc. item A.6.1.4)	Fire Tested (acc. item A.6.1.4)
20. Seat Type	Side A: SPE / Side B: DPE; DIB-2 & DBB (notes)	Side A: SPE / Side B: DPE; DIB-2 & DBB (notes)
21. Bore Type	Full Bore	Full Bore
22. Body Construction	split body, bolted	split body, bolted
23. Cladding or Coating	N/A	N/A
24. Valve Testing	FAT according A.9.3	FAT according A.9.3
25. Notes	Acceptance criteria for sealing tests see Annex A, DBB tests to be performed at both conditions, fully opened and closed, Vent and drain connections according Annex A	Acceptance criteria for sealing tests see Annex A, DBB tests to be performed at both conditions, fully opened and closed, Vent and drain connections according Annex A

A.12.3 RISING STEM

Valve Code	VES-600-2-A589	VES-600-3-A589
Specs	E32	E32
1. Valve Type	Rising Stem	Rising Stem
2. Sealing Type	Metal to Metal	Metal to Metal
3. Valve Specification Level (VSL)	VSL-2	VSL-3
4. Ball Mounting	Trunnion	Trunnion
5. Standard	API 6D	API 6D
6. Size Range (NPS)	2" - 16"	2" - 16"
7. End Connection	ASME B16.5, RF	ASME B16.5, RF
8. Pressure Class	600	600
9. Temperature	-100°C to 340°C	-100°C to 340°C
10. Material Class	Alloy Steel	Alloy Steel
11. Body Material	ASTM A350 Gr LF3 or ASTM A352 Gr LC3 + Inconel 625 weld overlay (acc. item A.7.1.7.3)	ASTM A350 Gr LF3 + Inconel 625 weld overlay (acc. item A.7.1.7.3)
12. Obturator Material	ASTM A350 Gr LF3 + Inconel 625 weld overlay (acc. item A.7.1.7.3) + Stellite (Co-Cr Alloy acc. item A.8.2.1.2)	ASTM A350 Gr LF3 + Inconel 625 weld overlay (acc. item A.7.1.7.3) + Stellite (Co-Cr Alloy acc. item A.8.2.1.2)
13. Seat Material	ASTM A350 Gr LF3 + Inconel 625 weld overlay (acc. item A.7.1.7.3) + Stellite (Co-Cr Alloy acc. item A.8.2.1.2)	ASTM A350 Gr LF3 + Inconel 625 weld overlay (acc. item A.7.1.7.3) + Stellite (Co-Cr Alloy acc. item A.8.2.1.2)
14. Seat Insert	N/A	N/A
15. Spring (Seat) Material	N/A	N/A
16. Stem Material	ASTM B637 (UNS N07718)	ASTM B637 (UNS N07718)
17. Seat-Stem Seal	Group F (acc. item A.7.1.5.6)	Group F (acc. item A.7.1.5.6)
18. Operator Type	Gearbox	Gearbox
19. Additional Requirement	Fire Tested (acc. item A.6.1.4)	Fire Tested (acc. item A.6.1.4)
20. Seat Type	N/A	N/A
21. Bore Type	Full Bore	Full Bore
22. Body Construction	Top entry, solid body	Top entry, solid body
23. Cladding or Coating	Full clad - Inconel 625 weld overlay on all wetted parts	Full clad - Inconel 625 weld overlay on all wetted parts
24. Valve Testing	FAT according A.9.3	FAT according A.9.3
25. Notes	N/A	N/A

A.12.4 DOUBLE BALL VALVES

Valve Code	VDE-10000-2-D301	VDE-10000-2-D303	VDE-10000-2-D371	VDE-10000-2-N101
Specs	J12P J12	J12P J12	J12P J12	J40P J40
1. Valve Type	Double Ball	Double Ball	Double Ball	Double Ball
2. Sealing Type	Soft	Metal to Metal, Soft	Metal to Metal	Soft
3. Valve Specification Level (VSL)	VSL-2	VSL-2	VSL-2	VSL-2
4. Obturator Type	Floating	Floating	N/A	Floating
5. Standard	API 6A	API 6A	API 6A	API 6A
6. Size Range (NPS)	1 13/16"	1 13/16"	N/A	1 13/16"
7. End Connection	Flange API 6A type 6BX	Flange API 6A type 6BX	N/A	Flange API 6A type 6BX
8. Pressure Class	max. press 10000 psi	max. press 10000 psi	max. press 10000 psi	max. press 10000 psi
9. Temperature	-30°C to 150°C	-50°C to 150°C	-50°C to 150°C	-30°C to 150°C
10. Material Class	Duplex Steel	Duplex Steel	Duplex Steel	Nickel Alloys
11. Body Material	ASTM A182 Gr F55	ASTM A182 Gr F55	ASTM A182 Gr F55	ASTM B564 (UNS N06625)
12. Obturator Material	Super Duplex (UNS S32760)	Super Duplex (UNS S32760)	Super Duplex (UNS S32760)	ASTM B564 (UNS N06625)
13. Seat Material	Super Duplex (UNS S32760)	Super Duplex (UNS S32760)	Super Duplex (UNS S32760)	ASTM B564 (UNS N06625)
14. Seat Insert Material	PEEK	N/A	N/A	PEEK
15. Spring Material	N/A	N/A	UNS N07750	N/A
16. Stem Material	ASTM A276 (UNS S32760)	ASTM A276 (UNS S32760)	ASTM A276 (UNS S32760)	ASTM B637 (UNS N07718)
17. Stem Seal Material	Group B (acc. item A.7.1.5.6)	Group E (acc. item A.7.1.5.6)	Group E (acc. item A.7.1.5.6)	Group B (acc. item A.7.1.5.6)
18. Operator Type	Lever	Lever	Gearbox	Lever
19. Additional Requirement	Fire Tested (acc. item A.6.1.4)	Fire Tested (acc. item A.6.1.4)	Fire Tested (acc. item A.6.1.4)	Fire Tested (acc. item A.6.1.4)
20. Seat Type	Side A: SPE / Side B: SPE	Side A: SPE / Side B: SPE	Side A: SPE / Side B: SPE	Side A: SPE / Side B: SPE
21. Bore Type	Reduced Bore (min. 10mm)	Reduced Bore (min. 10mm)	Full Bore	Reduced Bore (min. 10mm)
22. Body Construction	One piece forged body	One piece forged body	Compact flangeless single body double ball valve. Face to face according ASME B16.10	One piece forged body
23. Product Testing	FAT according A.9.3	FAT according A.9.3	FAT according A.9.3	FAT according A.9.3
24. Cladding or Coating	N/A	N/A	N/A	N/A
25. Notes	Needle valve between balls for cavity-pressure relief Max weight 55kg Minimum bore size 10mm	Needle valve between balls for cavity-pressure relief Max weight 55kg Minimum bore size 10mm	Needle valve between balls for cavity-pressure relief All materials described in this datasheet are required for both valve	Needle valve between balls for cavity-pressure relief Max weight 55kg Minimum bore size 10mm

Valve Code	VDE-10000-2-N102	VDE-10000-2-N103	VDE-10000-2-N104	VDE-10000-2-N171
Specs	J40P J40	J40P J40	J40P J40	J40P J40
1. Valve Type	Double Ball	Double Ball	Double Ball	Double Ball
2. Sealing Type	Soft	Metal to Metal	Metal to Metal	Metal to Metal
3. Valve Specification Level (VSL)	VSL-2	VSL-2	VSL-2	VSL-2
4. Obturator Type	Floating	Floating	Floating	N/A
5. Standard	API 6A	API 6A	API 6A	API 6A
6. Size Range (NPS)	1 13/16"	1 13/16"	1 13/16"	N/A
7. End Connection	Flange API 6A type 6BX x NPT 1/2" ASME B1.20.1	Flange API 6A type 6BX	Flange API 6A type 6BX x NPT 1/2" ASME B1.20.1	N/A
8. Pressure Class	max. press 10000 psi	max. press 10000 psi	max. press 10000 psi	max. press 10000 psi
9. Temperature	-30°C to 150°C	-100°C to 150°C	-100°C to 150°C	-50°C to 150°C
10. Material Class	Nickel Alloys	Nickel Alloys	Nickel Alloys	Nickel Alloys
11. Body Material	ASTM B564 (UNS N06625)	ASTM B564 (UNS N06625)	ASTM B564 (UNS N06625)	ASTM B564 (UNS N06625)
12. Obturator Material	ASTM B564 (UNS N06625)	ASTM B564 (UNS N06625) + Hard Coating (acc. Item A.7.1.7.4)	ASTM B564 (UNS N06625) + Hard Coating (acc. Item A.7.1.7.4)	ASTM B564 (UNS N06625)
13. Seat Material	ASTM B564 (UNS N06625)	ASTM B564 (UNS N06625) + Hard Coating (acc. Item A.7.1.7.4)	ASTM B564 (UNS N06625) + Hard Coating (acc. Item A.7.1.7.4)	ASTM B564 (UNS N06625)
14. Seat Insert Material	PEEK	N/A	N/A	N/A
15. Spring Material	N/A	N/A	N/A	UNS N07750
16. Stem Material	ASTM B637 (UNS N07718)	ASTM B637 (UNS N07718)	ASTM B637 (UNS N07718)	ASTM B637 (UNS N07718)
17. Stem Seal Material	Group B (acc. item A.7.1.5.6)	Group E (acc. item A.7.1.5.6)	Group E (acc. item A.7.1.5.6)	Group E (acc. item A.7.1.5.6)
18. Operator Type	Lever	Lever	Lever	Gearbox
19. Additional Requirement	Fire Tested (acc. item A.6.1.4)	Fire Tested (acc. item A.6.1.4)	Fire Tested (acc. item A.6.1.4)	Fire Tested (acc. item A.6.1.4)
20. Seat Type	Side A: SPE / Side B: SPE	Side A: SPE / Side B: SPE	Side A: SPE / Side B: SPE	Side A: SPE / Side B: SPE
21. Bore Type	Reduced Bore (min. 10mm)	Reduced Bore (min. 10mm)	Reduced Bore (min. 10mm)	Full Bore
22. Body Construction	One piece forged body	One piece forged body	One piece forged body	Compact flangeless single body double ball valve. Face to face according ASME B16.10
23. Product Testing	FAT according A.9.3	FAT according A.9.3	FAT according A.9.3	FAT according A.9.3
24. Cladding or Coating	N/A	N/A	N/A	N/A
25. Notes	Needle valve between balls for cavity-pressure relief Max weight 55kg Minimum bore size 10mm	Needle valve between balls for cavity-pressure relief Max weight 55kg Minimum bore size 10mm	Needle valve between balls for cavity-pressure relief Max weight 55kg Minimum bore size 10mm	Needle valve between balls for cavity-pressure relief All materials described in this datasheet are required for both valve

Valve Code	VDE-1500-2-C114	VDE-1500-2-C115	VDE-1500-2-C134	VDE-1500-2-C135
Specs	G10P	G10P	G10P	G10P
1. Valve Type	Double Ball	Double Ball	Double Ball	Double Ball
2. Sealing Type	Soft	Soft	Soft	Soft
3. Valve Specification Level (VSL)	VSL-2	VSL-2	VSL-2	VSL-2
4. Ball Mouting	Trunnion	Trunnion	Trunnion	Trunnion
5. Standard	API 6D / IOGP S-562	API 6D / IOGP S-562	API 6D / IOGP S-562	API 6D / IOGP S-562
6. Size Range (NPS)	3" - 8"	3" - 8"	3" - 8"	3" - 8"
7. End Connection	ASME B16.5, RTJ	ASME B16.5, RTJ	ASME B16.5, RTJ	ASME B16.5, RTJ
8. Pressure Class	1500	1500	1500	1500
9. Temperature	0°C to 150°C	-29°C to 150°C	0°C to 150°C	-29°C to 150°C
10. Material Class	Carbon Steel	Carbon Steel	Carbon Steel	Carbon Steel
11. Body Material	ASTM A105 + SS316 weld overlay (acc. item A.7.1.7.3)	ASTM A105 + SS316 weld overlay (acc. item A.7.1.7.3)	ASTM A105 + SS316 weld overlay (acc. item A.7.1.7.3)	ASTM A105 + Inconel 625 weld overlay (acc. item A.7.1.7.3)
12. Obturator Material	AISI 410	AISI 410	AISI 410	AISI 410
13. Seat Material	AISI 410	AISI 410	AISI 410	AISI 410
14. Seat Insert	PEEK	PEEK	PEEK	PEEK
15. Spring (Seat) Material	UNS N07750	UNS N07750	UNS N07750	UNS N07750
16. Stem Material	ASTM A276 (UNS S41000)	ASTM A276 (UNS S41000)	ASTM A276 (UNS S41000)	ASTM A276 (UNS S41000)
17. Seat-Stem Seal	Group A (acc. item A.7.1.5.6)	Group B (acc. item A.7.1.5.6)	Group D (acc. item A.7.1.5.6)	Group E (acc. item A.7.1.5.6)
18. Operator Type	Gearbox	Gearbox	Gearbox	Gearbox
19. Additional Requirement	N/A	Fire Tested (acc. item A.6.1.4)	N/A	Fire Tested (acc. item A.6.1.4)
20. Seat Type	Side A: SPE / Side B: SPE; DBB	Side A: SPE / Side B: SPE; DBB	Side A: SPE / Side B: SPE; DBB	Side A: SPE / Side B: SPE; DBB
21. Bore Type	Full Bore	Full Bore	Full Bore	Full Bore
22. Body Construction	Compact flangeless single body double ball valve. Face to face according ASME B16.10	Compact flangeless single body double ball valve. Face to face according ASME B16.10	Compact flangeless single body double ball valve. Face to face according ASME B16.10	Compact flangeless single body double ball valve. Face to face according ASME B16.10
23. Cladding or Coating	Partial clad - SS316 weld overlay on all body sealing areas	Partial clad - SS316 weld overlay on all body sealing areas	Partial clad - SS316 weld overlay on all body sealing areas	Partial clad - Inconel 625 weld overlay on all body sealing areas
24. Valve Testing	FAT according A.9.3	FAT according A.9.3	FAT according A.9.3	FAT according A.9.3
25. Notes	All materials described in this datasheet are required for both valve, Needle valve between balls for cavity-pressure relief	All materials described in this datasheet are required for both valve, Needle valve between balls for cavity-pressure relief	All materials described in this datasheet are required for both valve, Needle valve between balls for cavity-pressure relief	All materials described in this datasheet are required for both valve, Needle valve between balls for cavity-pressure relief

Valve Code	VDE-1500-2-C201	VDE-1500-2-C202	VDE-1500-2-C203	VDE-1500-2-C204
Specs	G10P	G10P	G10P	G10P
1. Valve Type	Double Ball	Double Ball	Double Ball	Double Ball
2. Sealing Type	Soft	Soft	Soft	Soft
3. Valve Specification Level (VSL)	VSL-2	VSL-2	VSL-2	VSL-2
4. Obturator Type	Trunnion	Trunnion	Trunnion	Trunnion
5. Standard	ASME B16.34	ASME B16.34	ASME B16.34	ASME B16.34
6. Size Range (NPS)	½" - 2"	½" - 2"	½" - 2"	½" - 2"
7. End Connection	Flange ASME B16.5, RTJ	Flange ASME B16.5, RTJ x NPT 1/2" ASME B1.20.1	Flange ASME B16.5, RTJ	Flange ASME B16.5, RTJ x NPT 1/2" ASME B1.20.1
8. Pressure Class	1500	1500	1500	1500
9. Temperature	-30°C to 150°C	-30°C to 150°C	-46°C to 150°C	-46°C to 150°C
10. Material Class	Carbon Steel	Carbon Steel	Carbon Steel	Carbon Steel
11. Body Material	ASTM A350 Gr LF2 CL1	ASTM A350 Gr LF2 CL1	ASTM A350 Gr LF2 CL1	ASTM A350 Gr LF2 CL1
12. Obturator Material	AISI 316	AISI 316	AISI 316	AISI 316
13. Seat Material	AISI 316	AISI 316	AISI 316	AISI 316
14. Seat Insert Material	PEEK	PEEK	PEEK	PEEK
15. Spring Material	UNS N07750	UNS N07750	UNS N07750	UNS N07750
16. Stem Material	ASTM A276 (UNS S31600)	ASTM A276 (UNS S31600)	ASTM A276 (UNS S31600)	ASTM A276 (UNS S31600)
17. Stem Seal Material	Group B (acc. item A.7.1.5.6)	Group B (acc. item A.7.1.5.6)	Group E (acc. item A.7.1.5.6)	Group E (acc. item A.7.1.5.6)
18. Operator Type	Lever	Lever	Lever	Lever
19. Additional Requirement	Fire Tested (acc. item A.6.1.4)	Fire Tested (acc. item A.6.1.4)	Fire Tested (acc. item A.6.1.4)	Fire Tested (acc. item A.6.1.4)
20. Seat Type	Side A: SPE / Side B: SPE	Side A: SPE / Side B: SPE	Side A: SPE / Side B: SPE	Side A: SPE / Side B: SPE
21. Bore Type	Full Bore	Full Bore	Full Bore	Full Bore
22. Body Construction	One piece forged body	One piece forged body	One piece forged body	One piece forged body
23. Product Testing	FAT according A.9.3	FAT according A.9.3	FAT according A.9.3	FAT according A.9.3
24. Cladding or Coating	N/A	N/A	N/A	N/A
25. Notes	Needle valve between balls for cavity-pressure relief Max weight 55kg Minimum bore size 10mm	Needle valve between balls for cavity-pressure relief Max weight 55kg Minimum bore size 10mm	Needle valve between balls for cavity-pressure relief Max weight 55kg Minimum bore size 10mm	Needle valve between balls for cavity-pressure relief Max weight 55kg Minimum bore size 10mm

Valve Code	VDE-1500-2-C205	VDE-1500-2-C206	VDE-1500-2-S201	VDE-1500-2-S202
Specs	G10P	G10P	G3	G3
1. Valve Type	Double Ball	Double Ball	Double Ball	Double Ball
2. Sealing Type	Metal to Metal	Metal to Metal	Soft	Soft
3. Valve Specification Level (VSL)	VSL-2	VSL-2	VSL-2	VSL-2
4. Obturator Type	Trunnion	Trunnion	Trunnion	Trunnion
5. Standard	ASME B16.34	ASME B16.34	ASME B16.34	ASME B16.34
6. Size Range (NPS)	½" - 2"	½" - 2"	½" - 2"	½" - 2"
7. End Connection	Flange ASME B16.5, RTJ	Flange ASME B16.5, RTJ x NPT 1/2" ASME B1.20.1	Flange ASME B16.5, RTJ	Flange ASME B16.5, RTJ x NPT 1/2" ASME B1.20.1
8. Pressure Class	1500	1500	1500	1500
9. Temperature	-46°C to 200°C	-46°C to 200°C	-30°C to 150°C	-30°C to 150°C
10. Material Class	Carbon Steel	Carbon Steel	Stainless Steel	Stainless Steel
11. Body Material	ASTM A350 Gr LF2 CL1	ASTM A350 Gr LF2 CL1	ASTM A182 Gr F316	ASTM A182 Gr F316
12. Obturator Material	AISI 316 + Hard Coating (acc. Item A.7.1.7.4)	AISI 316 + Hard Coating (acc. Item A.7.1.7.4)	AISI 316	AISI 316
13. Seat Material	AISI 316 + Hard Coating (acc. Item A.7.1.7.4)	AISI 316 + Hard Coating (acc. Item A.7.1.7.4)	AISI 316	AISI 316
14. Seat Insert Material	N/A	N/A	PEEK	PEEK
15. Spring Material	UNS N07750	UNS N07750	UNS N07750	UNS N07750
16. Stem Material	ASTM A276 (UNS S31600)	ASTM A276 (UNS S31600)	ASTM A276 (UNS S31600)	ASTM A276 (UNS S31600)
17. Stem Seal Material	Group E (acc. item A.7.1.5.6)	Group E (acc. item A.7.1.5.6)	Group B (acc. item A.7.1.5.6)	Group B (acc. item A.7.1.5.6)
18. Operator Type	Lever	Lever	Lever	Lever
19. Additional Requirement	Fire Tested (acc. item A.6.1.4)	Fire Tested (acc. item A.6.1.4)	Fire Tested (acc. item A.6.1.4)	Fire Tested (acc. item A.6.1.4)
20. Seat Type	Side A: SPE / Side B: SPE	Side A: SPE / Side B: SPE	Side A: SPE / Side B: SPE	Side A: SPE / Side B: SPE
21. Bore Type	Full Bore	Full Bore	Full Bore	Full Bore
22. Body Construction	One piece forged body	One piece forged body	One piece forged body	One piece forged body
23. Product Testing	FAT according A.9.3	FAT according A.9.3	FAT according A.9.3	FAT according A.9.3
24. Cladding or Coating	N/A	N/A	N/A	N/A
25. Notes	Needle valve between balls for cavity-pressure relief Max weight 55kg Minimum bore size 10mm	Needle valve between balls for cavity-pressure relief Max weight 55kg Minimum bore size 10mm	Needle valve between balls for cavity-pressure relief Max weight 55kg Minimum bore size 10mm	Needle valve between balls for cavity-pressure relief Max weight 55kg Minimum bore size 10mm

Valve Code	VDE-1500-2-S203	VDE-1500-2-S204	VDE-1500-2-S205	VDE-1500-2-S206
Specs	G3	G3	G3	G3
1. Valve Type	Double Ball	Double Ball	Double Ball	Double Ball
2. Sealing Type	Soft	Soft	Metal to Metal	Metal to Metal
3. Valve Specification Level (VSL)	VSL-2	VSL-2	VSL-2	VSL-2
4. Obturator Type	Trunnion	Trunnion	Trunnion	Trunnion
5. Standard	ASME B16.34	ASME B16.34	ASME B16.34	ASME B16.34
6. Size Range (NPS)	½" - 2"	½" - 2"	½" - 2"	½" - 2"
7. End Connection	Flange ASME B16.5, RTJ	Flange ASME B16.5, RTJ x NPT 1/2" ASME B1.20.1	Flange ASME B16.5, RTJ	Flange ASME B16.5, RTJ x NPT 1/2" ASME B1.20.1
8. Pressure Class	1500	1500	1500	1500
9. Temperature	-46°C to 150°C	-46°C to 150°C	-100°C to 200°C	-100°C to 200°C
10. Material Class	Stainless Steel	Stainless Steel	Stainless Steel	Stainless Steel
11. Body Material	ASTM A182 Gr F316	ASTM A182 Gr F316	ASTM A182 Gr F316	ASTM A182 Gr F316
12. Obturator Material	AISI 316	AISI 316	AISI 316 + Hard Coating (acc. Item A.7.1.7.4)	AISI 316 + Hard Coating (acc. Item A.7.1.7.4)
13. Seat Material	AISI 316	AISI 316	AISI 316 + Hard Coating (acc. Item A.7.1.7.4)	AISI 316 + Hard Coating (acc. Item A.7.1.7.4)
14. Seat Insert Material	PEEK	PEEK	N/A	N/A
15. Spring Material	UNS N07750	UNS N07750	UNS N07750	UNS N07750
16. Stem Material	ASTM A276 (UNS S31600)	ASTM A276 (UNS S31600)	ASTM A276 (UNS S31600)	ASTM A276 (UNS S31600)
17. Stem Seal Material	Group E (acc. item A.7.1.5.6)	Group E (acc. item A.7.1.5.6)	Group E (acc. item A.7.1.5.6)	Group E (acc. item A.7.1.5.6)
18. Operator Type	Lever	Lever	Lever	Lever
19. Additional Requirement	Fire Tested (acc. item A.6.1.4)	Fire Tested (acc. item A.6.1.4)	Fire Tested (acc. item A.6.1.4)	Fire Tested (acc. item A.6.1.4)
20. Seat Type	Side A: SPE / Side B: SPE	Side A: SPE / Side B: SPE	Side A: SPE / Side B: SPE	Side A: SPE / Side B: SPE
21. Bore Type	Full Bore	Full Bore	Full Bore	Full Bore
22. Body Construction	One piece forged body	One piece forged body	One piece forged body	One piece forged body
23. Product Testing	FAT according A.9.3	FAT according A.9.3	FAT according A.9.3	FAT according A.9.3
24. Cladding or Coating	N/A	N/A	N/A	N/A
25. Notes	Needle valve between balls for cavity-pressure relief Max weight 55kg Minimum bore size 10mm	Needle valve between balls for cavity-pressure relief Max weight 55kg Minimum bore size 10mm	Needle valve between balls for cavity-pressure relief Max weight 55kg Minimum bore size 10mm	Needle valve between balls for cavity-pressure relief Max weight 55kg Minimum bore size 10mm

Valve Code	VDE-1500-2-S214	VDE-1500-2-S215	VDE-1500-2-S234	VDE-1500-2-S235
Specs	G3	G3	G3	G3
1. Valve Type	Double Ball	Double Ball	Double Ball	Double Ball
2. Sealing Type	Soft	Soft	Soft	Soft
3. Valve Specification Level (VSL)	VSL-2	VSL-2	VSL-2	VSL-2
4. Ball Mouting	Trunnion	Trunnion	Trunnion	Trunnion
5. Standard	API 6D / IOGP S-562	API 6D / IOGP S-562	API 6D / IOGP S-562	API 6D / IOGP S-562
6. Size Range (NPS)	3" - 8"	3" - 8"	3" - 8"	3" - 8"
7. End Connection	ASME B16.5, RTJ	ASME B16.5, RTJ	ASME B16.5, RTJ	ASME B16.5, RTJ
8. Pressure Class	1500	1500	1500	1500
9. Temperature	-30°C to 150°C	-30°C to 150°C	-46°C to 150°C	-46°C to 150°C
10. Material Class	Stainless Steel	Stainless Steel	Stainless Steel	Stainless Steel
11. Body Material	ASTM A182 Gr F316	ASTM A182 Gr F316	ASTM A182 Gr F316 + Inconel 625 weld overlay (acc. item A.7.1.7.3)	ASTM A182 Gr F316 + Inconel 625 weld overlay (acc. item A.7.1.7.3)
12. Obturator Material	AISI 316	AISI 316	AISI 316	AISI 316
13. Seat Material	AISI 316	AISI 316	AISI 316	AISI 316
14. Seat Insert	PEEK	PEEK	PEEK	PEEK
15. Spring (Seat) Material	UNS N07750	UNS N07750	UNS N07750	UNS N07750
16. Stem Material	ASTM B637 (UNS N07718)	ASTM B637 (UNS N07718)	ASTM B637 (UNS N07718)	ASTM B637 (UNS N07718)
17. Seat-Stem Seal	Group B (acc. item A.7.1.5.6)	Group B (acc. item A.7.1.5.6)	Group E (acc. item A.7.1.5.6)	Group E (acc. item A.7.1.5.6)
18. Operator Type	Gearbox	Gearbox	Gearbox	Gearbox
19. Additional Requirement	N/A	Fire Tested (acc. item A.6.1.4)	N/A	Fire Tested (acc. item A.6.1.4)
20. Seat Type	Side A: SPE / Side B: SPE; DBB	Side A: SPE / Side B: SPE; DBB	Side A: SPE / Side B: SPE; DBB	Side A: SPE / Side B: SPE; DBB
21. Bore Type	Full Bore	Full Bore	Full Bore	Full Bore
22. Body Construction	Compact flangeless single body double ball valve. Face to face according ASME B16.10	Compact flangeless single body double ball valve. Face to face according ASME B16.10	Compact flangeless single body double ball valve. Face to face according ASME B16.10	Compact flangeless single body double ball valve. Face to face according ASME B16.10
23. Cladding or Coating	N/A	N/A	Partial clad - Inconel 625 weld overlay on all body sealing areas	Partial clad - Inconel 625 weld overlay on all body sealing areas
24. Valve Testing	FAT according A.9.3	FAT according A.9.3	FAT according A.9.3	FAT according A.9.3
25. Notes	All materials described in this datasheet are required for both valve, Needle valve between balls for cavity-pressure relief	All materials described in this datasheet are required for both valve, Needle valve between balls for cavity-pressure relief	All materials described in this datasheet are required for both valve, Needle valve between balls for cavity-pressure relief	All materials described in this datasheet are required for both valve, Needle valve between balls for cavity-pressure relief

Valve Code	VDE-1500-2-S270	VDE-150-2-C101	VDE-150-2-C102	VDE-150-2-C105
Specs	G3	B10	B10	B10
1. Valve Type	Double Ball	Double Ball	Double Ball	Double Ball
2. Sealing Type	Metal to Metal	Soft	Soft	Metal to Metal
3. Valve Specification Level (VSL)	VSL-2	VSL-2	VSL-2	VSL-2
4. Ball Mouting	Trunnion	Floating	Floating	Floating
5. Standard	API 6D / IOGP S-562	ASME B16.34	ASME B16.34	ASME B16.34
6. Size Range (NPS)	3" - 8"	½" - 2"	½" - 2"	½" - 2"
7. End Connection	ASME B16.5, RTJ	N/A	N/A	N/A
8. Pressure Class	1500	150	150	150
9. Temperature	-100°C to 200°C	-29°C to 150°C	-29°C to 150°C	-29°C to 200°C
10. Material Class	Stainless Steel	Carbon Steel	Carbon Steel	Carbon Steel
11. Body Material	ASTM A182 Gr F316	ASTM A105	ASTM A105	ASTM A105
12. Obturator Material	AISI 316	AISI 316	AISI 316	AISI 316
13. Seat Material	AISI 316	PTFE reinforced with 25% Carbon	PTFE reinforced with 25% Carbon	AISI 316
14. Seat Insert	N/A	N/A	N/A	N/A
15. Spring (Seat) Material	UNS N07750	N/A	N/A	N/A
16. Stem Material	ASTM B637 (UNS N07718)	ASTM A276 (UNS S31600)	ASTM A276 (UNS S31600)	ASTM A276 (UNS S31600)
17. Seat-Stem Seal	Group E (acc. item A.7.1.5.6)	Group B (acc. item A.7.1.5.6)	Group B (acc. item A.7.1.5.6)	Group E (acc. item A.7.1.5.6)
18. Operator Type	Gearbox	Lever	Lever	Lever
19. Additional Requirement	N/A	Fire Tested (acc. item A.6.1.4)	Fire Tested (acc. item A.6.1.4)	Fire Tested (acc. item A.6.1.4)
20. Seat Type	Side A: SPE / Side B: SPE	N/A	N/A	N/A
21. Bore Type	Full Bore	Full Bore	Full Bore	Full Bore
22. Body Construction	Compact flangeless single body double ball valve. Face to face according ASME B16.10	One piece forged body	One piece forged body	One piece forged body
23. Cladding or Coating	N/A	N/A	N/A	N/A
24. Valve Testing	FAT according A.9.3	FAT according A.9.3	FAT according A.9.3	FAT according A.9.3
25. Notes	All materials described in this datasheet are required for both valve, Needle valve between balls for cavity-pressure relief	Max weight 55kg, Minimum bore size 10mm, Needle valve between balls for cavity-pressure relief	Max weight 55kg, Minimum bore size 10mm, Needle valve between balls for cavity-pressure relief	Max weight 55kg, Minimum bore size 10mm, Needle valve between balls for cavity-pressure relief

Valve Code	VDE-150-2-C106	VDE-150-2-C107	VDE-150-2-C108	VDE-150-2-C114
Specs	B10	B10	B10	B10
1. Valve Type	Double Ball	Double Ball	Double Ball	Double Ball
2. Sealing Type	Metal to Metal	Metal to Metal	Metal to Metal	Soft
3. Valve Specification Level (VSL)	VSL-2	VSL-2	VSL-2	VSL-2
4. Obturator Type	Floating	Floating	Floating	N/A
5. Standard	ASME B16.34	ASME B16.34	ASME B16.34	API 6D / IOGP S-562
6. Size Range (NPS)	½" - 2"	½" - 2"	½" - 2"	3" - 8"
7. End Connection	Flange ASME B16.5, RF x NPT 1/2" ASME B1.20.1	Flange ASME B16.5, RF	Flange ASME B16.5, RF x NPT 1/2" ASME B1.20.1	N/A
8. Pressure Class	150	150	150	150
9. Temperature	-29°C to 200°C	-29°C to 340°C	-29°C to 340°C	-29°C to 150°C
10. Material Class	Carbon Steel	Carbon Steel	Carbon Steel	Carbon Steel
11. Body Material	ASTM A105	ASTM A105	ASTM A105	ASTM A105 or ASTM A216 Gr WCB
12. Obturator Material	AISI 316	AISI 316	AISI 316	AISI 410
13. Seat Material	AISI 316	AISI 316	AISI 316	AISI 410
14. Seat Insert Material	N/A	N/A	N/A	PEEK
15. Spring Material	N/A	N/A	N/A	UNS N07750
16. Stem Material	ASTM A276 (UNS S31600)	ASTM A276 (UNS S31600)	ASTM A276 (UNS S31600)	ASTM A276 (UNS S41000)
17. Stem Seal Material	Group E (acc. item A.7.1.5.6)	Group F (acc. item A.7.1.5.6)	Group F (acc. item A.7.1.5.6)	Group B (acc. item A.7.1.5.6)
18. Operator Type	Lever	Lever	Lever	N/A
19. Additional Requirement	Fire Tested (acc. item A.6.1.4)	Fire Tested (acc. item A.6.1.4)	Fire Tested (acc. item A.6.1.4)	N/A
20. Seat Type	N/A	N/A	N/A	Side A: SPE / Side B: SPE; DBB
21. Bore Type	Full Bore	Full Bore	Full Bore	Full Bore
22. Body Construction	One piece forged body	One piece forged body	One piece forged body	Compact flangeless single body double ball valve. Face to face according ASME B16.10
23. Product Testing	FAT according A.9.3	FAT according A.9.3	FAT according A.9.3	FAT according A.9.3
24. Cladding or Coating	N/A	N/A	N/A	Partial clad - SS316 weld overlay on all body sealing areas
25. Notes	Needle valve between balls for cavity-pressure relief Max weight 55kg Minimum bore size 10mm	Needle valve between balls for cavity-pressure relief Max weight 55kg Minimum bore size 10mm	Needle valve between balls for cavity-pressure relief Max weight 55kg Minimum bore size 10mm	Needle valve between balls for cavity-pressure relief All materials described in this datasheet are required for both valve

Valve Code	VDE-150-2-C115	VDE-150-2-C201	VDE-150-2-C202	VDE-150-2-C203
Specs	B10	B6 B19	B6 B19	B6 B19
1. Valve Type	Double Ball	Double Ball	Double Ball	Double Ball
2. Sealing Type	Soft	Soft	Soft	Soft
3. Valve Specification Level (VSL)	VSL-2	VSL-2	VSL-2	VSL-2
4. Ball Mouting	Trunnion	N/A	N/A	N/A
5. Standard	API 6D / IOGP S-562	ASME B16.34	ASME B16.34	ASME B16.34
6. Size Range (NPS)	3" - 8"	½" - 2"	½" - 2"	½" - 2"
7. End Connection	ASME B16.5, RF	N/A	N/A	N/A
8. Pressure Class	150	150	150	150
9. Temperature	-29°C to 150°C	-30°C to 150°C	-30°C to 150°C	-46°C to 150°C
10. Material Class	Carbon Steel	Carbon Steel	Carbon Steel	Carbon Steel
11. Body Material	ASTM A105 or ASTM A216 Gr WCB + SS316 weld overlay (acc. item A.7.1.7.3)	ASTM A350 Gr LF2 CL1	ASTM A350 Gr LF2 CL1	ASTM A350 Gr LF2 CL1
12. Obturator Material	AISI 410	AISI 316	AISI 316	AISI 316
13. Seat Material	AISI 410	PTFE reinforced with 25% Carbon	PTFE reinforced with 25% Carbon	PTFE reinforced with 25% Carbon
14. Seat Insert	PEEK	N/A	N/A	N/A
15. Spring (Seat) Material	UNS N07750	N/A	N/A	N/A
16. Stem Material	ASTM A276 (UNS S41000)	ASTM A276 (UNS S31600)	ASTM A276 (UNS S31600)	ASTM A276 (UNS S31600)
17. Seat-Stem Seal	Group B (acc. item A.7.1.5.6)	Group B (acc. item A.7.1.5.6)	Group B (acc. item A.7.1.5.6)	Group E (acc. item A.7.1.5.6)
18. Operator Type	3" Lever	N/A	N/A	N/A
	4" - 8" Gearbox	N/A	N/A	N/A
19. Additional Requirement	Fire Tested (acc. item A.6.1.4)	Fire Tested (acc. item A.6.1.4)	Fire Tested (acc. item A.6.1.4)	Fire Tested (acc. item A.6.1.4)
20. Seat Type	Side A: SPE / Side B: SPE; DBB	N/A	N/A	N/A
21. Bore Type	Full Bore	Full Bore	Full Bore	Full Bore
22. Body Construction	Compact flangeless single body double ball valve. Face to face according ASME B16.10	One piece forged body	One piece forged body	One piece forged body
23. Cladding or Coating	Partial clad - SS316 weld overlay on all body sealing areas	N/A	N/A	N/A
24. Valve Testing	FAT according A.9.3	FAT according A.9.3	FAT according A.9.3	FAT according A.9.3
25. Notes	All materials described in this datasheet are required for both valve, Needle valve between balls for cavity-pressure relief	Max weight 55kg, Minimum bore size 10mm, Needle valve between balls for cavity-pressure relief	Max weight 55kg, Minimum bore size 10mm, Needle valve between balls for cavity-pressure relief	Max weight 55kg, Minimum bore size 10mm, Needle valve between balls for cavity-pressure relief

Valve Code	VDE-150-2-C204	VDE-150-2-C205	VDE-150-2-C206	VDE-150-2-C207
Specs	B6 B19	B6 B19	B6 B19	B6 B19
1. Valve Type	Double Ball	Double Ball	Double Ball	Double Ball
2. Sealing Type	Soft	Metal to Metal	Metal to Metal	Metal to Metal
3. Valve Specification Level (VSL)	VSL-2	VSL-2	VSL-2	VSL-2
4. Obturator Type	Floating	Floating	Floating	Floating
5. Standard	ASME B16.34	ASME B16.34	ASME B16.34	ASME B16.34
6. Size Range (NPS)	½" - 2"	½" - 2"	½" - 2"	½" - 2"
7. End Connection	Flange ASME B16.5, RF x NPT 1/2" ASME B1.20.1	Flange ASME B16.5, RF	Flange ASME B16.5, RF x NPT 1/2" ASME B1.20.1	Flange ASME B16.5, RF
8. Pressure Class	150	150	150	150
9. Temperature	-46°C to 150°C	-46°C to 200°C	-46°C to 200°C	-46°C to 340°C
10. Material Class	Carbon Steel	Carbon Steel	Carbon Steel	Carbon Steel
11. Body Material	ASTM A350 Gr LF2 CL1	ASTM A350 Gr LF2 CL1	ASTM A350 Gr LF2 CL1	ASTM A350 Gr LF2 CL1
12. Obturator Material	AISI 316	AISI 316	AISI 316	AISI 316
13. Seat Material	PTFE reinforced with 25% Carbon	AISI 316	AISI 316	AISI 316
14. Seat Insert Material	N/A	N/A	N/A	N/A
15. Spring Material	N/A	N/A	N/A	N/A
16. Stem Material	ASTM A276 (UNS S31600)	ASTM A276 (UNS S31600)	ASTM A276 (UNS S31600)	ASTM A276 (UNS S31600)
17. Stem Seal Material	Group E (acc. item A.7.1.5.6)	Group E (acc. item A.7.1.5.6)	Group E (acc. item A.7.1.5.6)	Group F (acc. item A.7.1.5.6)
18. Operator Type	Lever	Lever	Lever	Lever
19. Additional Requirement	Fire Tested (acc. item A.6.1.4)	Fire Tested (acc. item A.6.1.4)	Fire Tested (acc. item A.6.1.4)	Fire Tested (acc. item A.6.1.4)
20. Seat Type	N/A	N/A	N/A	N/A
21. Bore Type	Full Bore	Full Bore	Full Bore	Full Bore
22. Body Construction	One piece forged body	One piece forged body	One piece forged body	One piece forged body
23. Product Testing	FAT according A.9.3	FAT according A.9.3	FAT according A.9.3	FAT according A.9.3
24. Cladding or Coating	N/A	N/A	N/A	N/A
25. Notes	Needle valve between balls for cavity-pressure relief Max weight 55kg Minimum bore size 10mm	Needle valve between balls for cavity-pressure relief Max weight 55kg Minimum bore size 10mm	Needle valve between balls for cavity-pressure relief Max weight 55kg Minimum bore size 10mm	Needle valve between balls for cavity-pressure relief Max weight 55kg Minimum bore size 10mm

Valve Code	VDE-150-2-C208	VDE-150-2-C215	VDE-150-2-C515	VDE-150-2-D201
Specs	B6 B19	B6 B19	B30	B11 B16
1. Valve Type	Double Ball	Double Ball	Double Ball	Double Ball
2. Sealing Type	Metal to Metal	Soft	Soft	Soft
3. Valve Specification Level (VSL)	VSL-2	VSL-2	VSL-2	VSL-2
4. Obturator Type	Floating	N/A	N/A	Floating
5. Standard	ASME B16.34	API 6D / IOGP S-562	API 6D / IOGP S-562	ASME B16.34
6. Size Range (NPS)	½" - 2"	3" - 8"	3" - 8"	½" - 2"
7. End Connection	Flange ASME B16.5, RF x NPT 1/2" ASME B1.20.1	N/A	N/A	Flange ASME B16.5, RF
8. Pressure Class	150	150	150	150
9. Temperature	-46°C to 340°C	-30°C to 150°C	-29°C to 150°C	-30°C to 150°C
10. Material Class	Carbon Steel	Carbon Steel	Carbon Steel	Duplex Steel
11. Body Material	ASTM A350 Gr LF2 CL1	ASTM A350 Gr LF2 CL1 or ASTM A352 Gr LCB	ASTM A105 or ASTM A216 Gr WCB	ASTM A182 Gr F51
12. Obturator Material	AISI 316	AISI 316	AISI 316	Duplex (UNS S31803)
13. Seat Material	AISI 316	AISI 410	AISI 316	PTFE reinforced with 25% Carbon
14. Seat Insert Material	N/A	PEEK	PEEK	N/A
15. Spring Material	N/A	UNS N07750	UNS N07750	N/A
16. Stem Material	ASTM A276 (UNS S31600)	ASTM A276 (UNS S31600)	ASTM B637 (UNS N07718)	ASTM A276 (UNS S31803)
17. Stem Seal Material	Group F (acc. item A.7.1.5.6)	Group B (acc. item A.7.1.5.6)	Group B (acc. item A.7.1.5.6)	Group B (acc. item A.7.1.5.6)
18. Operator Type	Lever	N/A	N/A	Lever
19. Additional Requirement	Fire Tested (acc. item A.6.1.4)	Fire Tested (acc. item A.6.1.4)	Fire Tested (acc. item A.6.1.4)	Fire Tested (acc. item A.6.1.4)
20. Seat Type	N/A	Side A: SPE / Side B: SPE; DBB	Side A: SPE / Side B: SPE; DBB	N/A
21. Bore Type	Full Bore	Full Bore	Full Bore	Full Bore
22. Body Construction	One piece forged body	Compact flangeless single body double ball valve. Face to face according ASME B16.10	Compact flangeless single body double ball valve. Face to face according ASME B16.10	One piece forged body
23. Product Testing	FAT according A.9.3	FAT according A.9.3	FAT according A.9.3	FAT according A.9.3
24. Cladding or Coating	N/A	Partial clad - SS316 weld overlay on all body sealing areas	Full clad - Inconel 625 weld overlay on all wetted parts	N/A
25. Notes	Needle valve between balls for cavity-pressure relief Max weight 55kg Minimum bore size 10mm	Needle valve between balls for cavity-pressure relief All materials described in this datasheet are required for both valve	Needle valve between balls for cavity-pressure relief All materials described in this datasheet are required for both valve	Needle valve between balls for cavity-pressure relief Max weight 55kg Minimum bore size 10mm

Valve Code	VDE-150-2-D202	VDE-150-2-D203	VDE-150-2-D204	VDE-150-2-D301
Specs	B11 B16	B11 B16	B11 B16	B12
1. Valve Type	Double Ball	Double Ball	Double Ball	Double Ball
2. Sealing Type	Soft	Soft	Soft	Soft
3. Valve Specification Level (VSL)	VSL-2	VSL-2	VSL-2	VSL-2
4. Obturator Type	Floating	Floating	Floating	Floating
5. Standard	ASME B16.34	ASME B16.34	ASME B16.34	ASME B16.34
6. Size Range (NPS)	½" - 2"	½" - 2"	½" - 2"	½" - 2"
7. End Connection	Flange ASME B16.5, RF x NPT 1/2" ASME B1.20.1	Flange ASME B16.5, RF	Flange ASME B16.5, RF x NPT 1/2" ASME B1.20.1	Flange ASME B16.5, RF
8. Pressure Class	150	150	150	150
9. Temperature	-30°C to 150°C	-46°C to 150°C	-46°C to 150°C	-30°C to 150°C
10. Material Class	Duplex Steel	Duplex Steel	Duplex Steel	Duplex Steel
11. Body Material	ASTM A182 Gr F51	ASTM A182 Gr F51	ASTM A182 Gr F51	ASTM A182 Gr F55
12. Obturator Material	Duplex (UNS S31803)	Duplex (UNS S31803)	Duplex (UNS S31803)	Super Duplex (UNS S32760)
13. Seat Material	PTFE reinforced with 25% Carbon	PTFE reinforced with 25% Carbon	PTFE reinforced with 25% Carbon	PTFE reinforced with 25% Carbon
14. Seat Insert Material	N/A	N/A	N/A	N/A
15. Spring Material	N/A	N/A	N/A	N/A
16. Stem Material	ASTM A276 (UNS S31803)	ASTM A276 (UNS S31803)	ASTM A276 (UNS S31803)	ASTM A276 (UNS S32760)
17. Stem Seal Material	Group B (acc. item A.7.1.5.6)	Group E (acc. item A.7.1.5.6)	Group E (acc. item A.7.1.5.6)	Group B (acc. item A.7.1.5.6)
18. Operator Type	Lever	Lever	Lever	Lever
19. Additional Requirement	Fire Tested (acc. item A.6.1.4)	Fire Tested (acc. item A.6.1.4)	Fire Tested (acc. item A.6.1.4)	Fire Tested (acc. item A.6.1.4)
20. Seat Type	N/A	N/A	N/A	N/A
21. Bore Type	Full Bore	Full Bore	Full Bore	Full Bore
22. Body Construction	One piece forged body	One piece forged body	One piece forged body	One piece forged body
23. Product Testing	FAT according A.9.3	FAT according A.9.3	FAT according A.9.3	FAT according A.9.3
24. Cladding or Coating	N/A	N/A	N/A	N/A
25. Notes	Needle valve between balls for cavity-pressure relief Max weight 55kg Minimum bore size 10mm	Needle valve between balls for cavity-pressure relief Max weight 55kg Minimum bore size 10mm	Needle valve between balls for cavity-pressure relief Max weight 55kg Minimum bore size 10mm	Needle valve between balls for cavity-pressure relief Max weight 55kg Minimum bore size 10mm

Valve Code	VDE-150-2-D302	VDE-150-2-D303	VDE-150-2-D304	VDE-150-2-N101
Specs	B12	B12	B12	B30
1. Valve Type	Double Ball	Double Ball	Double Ball	Double Ball
2. Sealing Type	Soft	Soft	Soft	Soft
3. Valve Specification Level (VSL)	VSL-2	VSL-2	VSL-2	VSL-2
4. Obturator Type	Floating	Floating	Floating	Floating
5. Standard	ASME B16.34	ASME B16.34	ASME B16.34	ASME B16.34
6. Size Range (NPS)	½" - 2"	½" - 2"	½" - 2"	½" - 2"
7. End Connection	Flange ASME B16.5, RF x NPT 1/2" ASME B1.20.1	Flange ASME B16.5, RF	Flange ASME B16.5, RF x NPT 1/2" ASME B1.20.1	Flange ASME B16.5, RF
8. Pressure Class	150	150	150	150
9. Temperature	-30°C to 150°C	-46°C to 150°C	-46°C to 150°C	-30°C to 150°C
10. Material Class	Duplex Steel	Duplex Steel	Duplex Steel	Nickel Alloys
11. Body Material	ASTM A182 Gr F55	ASTM A182 Gr F55	ASTM A182 Gr F55	ASTM B564 (UNS N06625)
12. Obturator Material	Super Duplex (UNS S32760)	Super Duplex (UNS S32760)	Super Duplex (UNS S32760)	ASTM B564 (UNS N06625)
13. Seat Material	PTFE reinforced with 25% Carbon	PTFE reinforced with 25% Carbon	PTFE reinforced with 25% Carbon	PTFE reinforced with 25% Carbon
14. Seat Insert Material	N/A	N/A	N/A	N/A
15. Spring Material	N/A	N/A	N/A	N/A
16. Stem Material	ASTM A276 (UNS S32760)	ASTM A276 (UNS S32760)	ASTM A276 (UNS S32760)	ASTM B637 (UNS N07718)
17. Stem Seal Material	Group B (acc. item A.7.1.5.6)	Group E (acc. item A.7.1.5.6)	Group E (acc. item A.7.1.5.6)	Group B (acc. item A.7.1.5.6)
18. Operator Type	Lever	Lever	Lever	Lever
19. Additional Requirement	Fire Tested (acc. item A.6.1.4)	Fire Tested (acc. item A.6.1.4)	Fire Tested (acc. item A.6.1.4)	Fire Tested (acc. item A.6.1.4)
20. Seat Type	N/A	N/A	N/A	N/A
21. Bore Type	Full Bore	Full Bore	Full Bore	Full Bore
22. Body Construction	One piece forged body	One piece forged body	One piece forged body	One piece forged body
23. Product Testing	FAT according A.9.3	FAT according A.9.3	FAT according A.9.3	FAT according A.9.3
24. Cladding or Coating	N/A	N/A	N/A	N/A
25. Notes	Needle valve between balls for cavity-pressure relief Max weight 55kg Minimum bore size 10mm	Needle valve between balls for cavity-pressure relief Max weight 55kg Minimum bore size 10mm	Needle valve between balls for cavity-pressure relief Max weight 55kg Minimum bore size 10mm	Needle valve between balls for cavity-pressure relief Max weight 55kg Minimum bore size 10mm

Valve Code	VDE-150-2-N102	VDE-150-2-N105	VDE-150-2-N106	VDE-150-2-S201
Specs	B30	B30	B30	B3
1. Valve Type	Double Ball	Double Ball	Double Ball	Double Ball
2. Sealing Type	Soft	Metal to Metal	Metal to Metal	Soft
3. Valve Specification Level (VSL)	VSL-2	VSL-2	VSL-2	VSL-2
4. Obturator Type	Floating	Floating	Floating	Floating
5. Standard	ASME B16.34	ASME B16.34	ASME B16.34	ASME B16.34
6. Size Range (NPS)	½" - 2"	½" - 2"	½" - 2"	½" - 2"
7. End Connection	Flange ASME B16.5, RF x NPT 1/2" ASME B1.20.1	Flange ASME B16.5, RF	Flange ASME B16.5, RF x NPT 1/2" ASME B1.20.1	Flange ASME B16.5, RF
8. Pressure Class	150	150	150	150
9. Temperature	-30°C to 150°C	-100°C to 200°C	-100°C to 200°C	-30°C to 150°C
10. Material Class	Nickel Alloys	Nickel Alloys	Nickel Alloys	Stainless Steel
11. Body Material	ASTM B564 (UNS N06625)	ASTM B564 (UNS N06625)	ASTM B564 (UNS N06625)	ASTM A182 Gr F316
12. Obturator Material	ASTM B564 (UNS N06625)	ASTM B564 (UNS N06625)	ASTM B564 (UNS N06625)	AISI 316
13. Seat Material	PTFE reinforced with 25% Carbon	ASTM B564 (UNS N06625)	ASTM B564 (UNS N06625)	PTFE reinforced with 25% Carbon
14. Seat Insert Material	N/A	N/A	N/A	N/A
15. Spring Material	N/A	N/A	N/A	N/A
16. Stem Material	ASTM B637 (UNS N07718)	ASTM B637 (UNS N07718)	ASTM B637 (UNS N07718)	ASTM A276 (UNS S31600)
17. Stem Seal Material	Group B (acc. item A.7.1.5.6)	Group E (acc. item A.7.1.5.6)	Group E (acc. item A.7.1.5.6)	Group B (acc. item A.7.1.5.6)
18. Operator Type	Lever	Lever	Lever	Lever
19. Additional Requirement	Fire Tested (acc. item A.6.1.4)	Fire Tested (acc. item A.6.1.4)	Fire Tested (acc. item A.6.1.4)	Fire Tested (acc. item A.6.1.4)
20. Seat Type	N/A	N/A	N/A	N/A
21. Bore Type	Full Bore	Full Bore	Full Bore	Full Bore
22. Body Construction	One piece forged body	One piece forged body	One piece forged body	One piece forged body
23. Product Testing	FAT according A.9.3	FAT according A.9.3	FAT according A.9.3	FAT according A.9.3
24. Cladding or Coating	N/A	N/A	N/A	N/A
25. Notes	Needle valve between balls for cavity-pressure relief Max weight 55kg Minimum bore size 10mm	Needle valve between balls for cavity-pressure relief Max weight 55kg Minimum bore size 10mm	Needle valve between balls for cavity-pressure relief Max weight 55kg Minimum bore size 10mm	Needle valve between balls for cavity-pressure relief Max weight 55kg Minimum bore size 10mm

Valve Code	VDE-150-2-S202	VDE-150-2-S203	VDE-150-2-S204	VDE-150-2-S205
Specs	B3	B3	B3	B3
1. Valve Type	Double Ball	Double Ball	Double Ball	Double Ball
2. Sealing Type	Soft	Soft	Soft	Metal to Metal
3. Valve Specification Level (VSL)	VSL-2	VSL-2	VSL-2	VSL-2
4. Obturator Type	Floating	Floating	Floating	Floating
5. Standard	ASME B16.34	ASME B16.34	ASME B16.34	ASME B16.34
6. Size Range (NPS)	½" - 2"	N/A	½" - 2"	½" - 2"
7. End Connection	Flange ASME B16.5, RF x NPT 1/2" ASME B1.20.1	Flange ASME B16.5, RF	Flange ASME B16.5, RF x NPT 1/2" ASME B1.20.1	Flange ASME B16.5, RF
8. Pressure Class	150	150	150	150
9. Temperature	-30°C to 150°C	-100°C to 150°C	-100°C to 150°C	-100°C to 200°C
10. Material Class	Stainless Steel	Stainless Steel	Stainless Steel	Stainless Steel
11. Body Material	ASTM A182 Gr F316	ASTM A182 Gr F316	ASTM A182 Gr F316	ASTM A182 Gr F316
12. Obturator Material	AISI 316	AISI 316	AISI 316	AISI 316
13. Seat Material	PTFE reinforced with 25% Carbon	PTFE reinforced with 25% Carbon	PTFE reinforced with 25% Carbon	AISI 316
14. Seat Insert Material	N/A	N/A	N/A	N/A
15. Spring Material	N/A	N/A	N/A	N/A
16. Stem Material	ASTM A276 (UNS S31600)	ASTM A276 (UNS S31600)	ASTM A276 (UNS S31600)	ASTM A276 (UNS S31600)
17. Stem Seal Material	Group B (acc. item A.7.1.5.6)	Group E (acc. item A.7.1.5.6)	Group E (acc. item A.7.1.5.6)	Group E (acc. item A.7.1.5.6)
18. Operator Type	Lever	Lever	Lever	Lever
19. Additional Requirement	Fire Tested (acc. item A.6.1.4)	Fire Tested (acc. item A.6.1.4)	Fire Tested (acc. item A.6.1.4)	Fire Tested (acc. item A.6.1.4)
20. Seat Type	N/A	N/A	N/A	N/A
21. Bore Type	Full Bore	Full Bore	Full Bore	Full Bore
22. Body Construction	One piece forged body	One piece forged body	One piece forged body	One piece forged body
23. Product Testing	FAT according A.9.3	FAT according A.9.3	FAT according A.9.3	FAT according A.9.3
24. Cladding or Coating	N/A	N/A	N/A	N/A
25. Notes	Needle valve between balls for cavity-pressure relief Max weight 55kg Minimum bore size 10mm	Needle valve between balls for cavity-pressure relief Max weight 55kg Minimum bore size 10mm	Needle valve between balls for cavity-pressure relief Max weight 55kg Minimum bore size 10mm	Needle valve between balls for cavity-pressure relief Max weight 55kg Minimum bore size 10mm

Valve Code	VDE-150-2-S206	VDE-150-2-S207	VDE-150-2-S208	VDE-2500-2-C101
Specs	B3	B3	B3	H10
1. Valve Type	Double Ball	Double Ball	Double Ball	Double Ball
2. Sealing Type	Metal to Metal	Metal to Metal	Metal to Metal	Soft
3. Valve Specification Level (VSL)	VSL-2	VSL-2	VSL-2	VSL-2
4. Obturator Type	Floating	Floating	Floating	Trunnion
5. Standard	ASME B16.34	ASME B16.34	ASME B16.34	ASME B16.34
6. Size Range (NPS)	½" - 2"	½" - 2"	½" - 2"	1" - 2"
7. End Connection	Flange ASME B16.5, RF x NPT 1/2" ASME B1.20.1	Flange ASME B16.5, RF	Flange ASME B16.5, RF x NPT 1/2" ASME B1.20.1	Flange ASME B16.5, RTJ
8. Pressure Class	150	150	150	2500
9. Temperature	-100°C to 200°C	-100°C to 340°C	-100°C to 340°C	-29°C to 150°C
10. Material Class	Stainless Steel	Stainless Steel	Stainless Steel	Carbon Steel
11. Body Material	ASTM A182 Gr F316	ASTM A182 Gr F316	ASTM A182 Gr F316	ASTM A105
12. Obturator Material	AISI 316	AISI 316	AISI 316	AISI 410
13. Seat Material	AISI 316	AISI 316	AISI 316	AISI 410
14. Seat Insert Material	N/A	N/A	N/A	PEEK
15. Spring Material	N/A	N/A	N/A	UNS N07750
16. Stem Material	ASTM A276 (UNS S31600)	ASTM A276 (UNS S31600)	ASTM A276 (UNS S31600)	ASTM A276 (UNS S41000)
17. Stem Seal Material	Group E (acc. item A.7.1.5.6)	Group F (acc. item A.7.1.5.6)	Group F (acc. item A.7.1.5.6)	Group B (acc. item A.7.1.5.6)
18. Operator Type	Lever	Lever	Lever	Lever
19. Additional Requirement	Fire Tested (acc. item A.6.1.4)	Fire Tested (acc. item A.6.1.4)	Fire Tested (acc. item A.6.1.4)	Fire Tested (acc. item A.6.1.4)
20. Seat Type	N/A	N/A	N/A	Side A: SPE / Side B: SPE
21. Bore Type	Full Bore	Full Bore	Full Bore	Full Bore
22. Body Construction	One piece forged body	One piece forged body	One piece forged body	One piece forged body
23. Product Testing	FAT according A.9.3	FAT according A.9.3	FAT according A.9.3	FAT according A.9.3
24. Cladding or Coating	N/A	N/A	N/A	N/A
25. Notes	Needle valve between balls for cavity-pressure relief Max weight 55kg Minimum bore size 10mm	Needle valve between balls for cavity-pressure relief Max weight 55kg Minimum bore size 10mm	Needle valve between balls for cavity-pressure relief Max weight 55kg Minimum bore size 10mm	Needle valve between balls for cavity-pressure relief Max weight 55kg Minimum bore size 10mm

Valve Code	VDE-2500-2-C102	VDE-2500-2-C115	VDE-2500-2-C203	VDE-2500-2-C204
Specs	H10	H10	H6	H6
1. Valve Type	Double Ball	Double Ball	Double Ball	Double Ball
2. Sealing Type	Soft	Soft	Soft	Soft
3. Valve Specification Level (VSL)	VSL-2	VSL-2	VSL-2	VSL-2
4. Obturator Type	Trunnion	Trunnion	Trunnion	Trunnion
5. Standard	ASME B16.34	API 6D / IOGP S-562	ASME B16.34	ASME B16.34
6. Size Range (NPS)	1" - 2"	3" - 8"	1" - 2"	1" - 2"
7. End Connection	Flange ASME B16.5, RTJ x NPT 1/2" ASME B1.20.1	N/A	Flange ASME B16.5, RTJ	Flange ASME B16.5, RTJ x NPT 1/2" ASME B1.20.1
8. Pressure Class	2500	2500	2500	2500
9. Temperature	-29°C to 150°C	-29°C to 150°C	-46°C to 150°C	-46°C to 150°C
10. Material Class	Carbon Steel	Carbon Steel	Carbon Steel	Carbon Steel
11. Body Material	ASTM A105	ASTM A105	ASTM A350 Gr LF2 CL1	ASTM A350 Gr LF2 CL1
12. Obturator Material	AISI 410	AISI 410	AISI 316	AISI 316
13. Seat Material	AISI 410	AISI 410	AISI 316	AISI 316
14. Seat Insert Material	PEEK	PEEK	PEEK	PEEK
15. Spring Material	UNS N07750	UNS N07750	UNS N07750	UNS N07750
16. Stem Material	ASTM A276 (UNS S41000)	ASTM A276 (UNS S41000)	ASTM B637 (UNS N07718)	ASTM B637 (UNS N07718)
17. Stem Seal Material	Group B (acc. item A.7.1.5.6)	Group B (acc. item A.7.1.5.6)	Group E (acc. item A.7.1.5.6)	Group E (acc. item A.7.1.5.6)
18. Operator Type	Lever	Gearbox	Lever	Lever
19. Additional Requirement	Fire Tested (acc. item A.6.1.4)	Fire Tested (acc. item A.6.1.4)	Fire Tested (acc. item A.6.1.4)	Fire Tested (acc. item A.6.1.4)
20. Seat Type	Side A: SPE / Side B: SPE	Side A: SPE / Side B: SPE; DBB	Side A: SPE / Side B: SPE	Side A: SPE / Side B: SPE
21. Bore Type	Full Bore	Full Bore	Full Bore	Full Bore
22. Body Construction	One piece forged body	Compact flangeless single body double ball valve. Face to face according ASME B16.10	One piece forged body	One piece forged body
23. Product Testing	FAT according A.9.3	FAT according A.9.3	FAT according A.9.3	FAT according A.9.3
24. Cladding or Coating	N/A	Partial clad - SS316 weld overlay on all body sealing areas	N/A	N/A
25. Notes	Needle valve between balls for cavity-pressure relief Max weight 55kg Minimum bore size 10mm	Needle valve between balls for cavity-pressure relief All materials described in this datasheet are required for both valve	Needle valve between balls for cavity-pressure relief Max weight 55kg Minimum bore size 10mm	Needle valve between balls for cavity-pressure relief Max weight 55kg Minimum bore size 10mm

Valve Code	VDE-2500-2-C205	VDE-2500-2-C215	VDE-2500-2-C235	VDE-2500-2-C271
Specs	H6	H6	H6	H6
1. Valve Type	Double Ball	Double Ball	Double Ball	Double Ball
2. Sealing Type	Metal to Metal	Soft	Soft	Metal to Metal
3. Valve Specification Level (VSL)	VSL-2	VSL-2	VSL-2	VSL-2
4. Obturator Type	Trunnion	Trunnion	Trunnion	N/A
5. Standard	ASME B16.34	API 6D / IOGP S-562	API 6D / IOGP S-562	API 6D / IOGP S-562
6. Size Range (NPS)	1" - 2"	3" - 8"	3" - 8"	3"
7. End Connection	Compact Flange ISO 27509 IX Ring	N/A	N/A	N/A
8. Pressure Class	2500	2500	2500	2500
9. Temperature	-46°C to 200°C	-30°C to 150°C	-46°C to 150°C	-46°C to 200°C
10. Material Class	Carbon Steel	Carbon Steel	Carbon Steel	Carbon Steel
11. Body Material	ASTM A350 Gr LF2 CL1	ASTM A350 Gr LF2 CL1	ASTM A350 Gr LF2 CL1	ASTM A350 Gr LF2 CL1
12. Obturator Material	AISI 316 + Hard Coating (acc. Item A.7.1.7.4)	AISI 316	AISI 316	AISI 316
13. Seat Material	AISI 316 + Hard Coating (acc. Item A.7.1.7.4)	AISI 316	AISI 316	AISI 316
14. Seat Insert Material	N/A	PEEK	PEEK	N/A
15. Spring Material	UNS N07750	UNS N07750	UNS N07750	UNS N07750
16. Stem Material	ASTM A276 (UNS S31600)	ASTM B637 (UNS N07718)	ASTM B637 (UNS N07718)	ASTM B637 (UNS N07718)
17. Stem Seal Material	Group E (acc. item A.7.1.5.6)	Group B (acc. item A.7.1.5.6)	Group E (acc. item A.7.1.5.6)	Group E (acc. item A.7.1.5.6)
18. Operator Type	Lever	Gearbox	Gearbox	Gearbox
19. Additional Requirement	Fire Tested (acc. item A.6.1.4)	Fire Tested (acc. item A.6.1.4)	Fire Tested (acc. item A.6.1.4)	Fire Tested (acc. item A.6.1.4)
20. Seat Type	Side A: SPE / Side B: SPE	Side A: SPE / Side B: SPE; DBB	Side A: SPE / Side B: SPE; DBB	Side A: SPE / Side B: SPE
21. Bore Type	Full Bore	Full Bore	Full Bore	Full Bore
22. Body Construction	One piece forged body	Compact flangeless single body double ball valve. Face to face according ASME B16.10	Compact flangeless single body double ball valve. Face to face according ASME B16.10	Compact flangeless single body double ball valve. Face to face according ASME B16.10
23. Product Testing	FAT according A.9.3	FAT according A.9.3	FAT according A.9.3	FAT according A.9.3
24. Cladding or Coating	N/A	Partial clad - SS316 weld overlay on all body sealing areas	Partial clad - Inconel 625 weld overlay on all body sealing areas	Partial clad - Inconel 625 weld overlay on all body sealing areas
25. Notes	Needle valve between balls for cavity-pressure relief Max weight 55kg Minimum bore size 10mm	Needle valve between balls for cavity-pressure relief All materials described in this datasheet are required for both valve	Needle valve between balls for cavity-pressure relief All materials described in this datasheet are required for both valve	Needle valve between balls for cavity-pressure relief All materials described in this datasheet are required for both valve

Valve Code	VDE-2500-2-C515	VDE-2500-2-D303	VDE-2500-2-D304	VDE-2500-2-D305
Specs	H30	H12P H12	H12P H12	H12P H12
1. Valve Type	Double Ball	Double Ball	Double Ball	Double Ball
2. Sealing Type	Soft	Soft	Soft	Metal to Metal
3. Valve Specification Level (VSL)	VSL-2	VSL-2	VSL-2	VSL-2
4. Ball Mouting	Trunnion	Trunnion	Trunnion	Trunnion
5. Standard	API 6D / IOGP S-562	ASME B16.34	ASME B16.34	ASME B16.34
6. Size Range (NPS)	3" - 8"	1" - 2"	1" - 2"	1" - 2"
7. End Connection	ASME B16.5, RTJ	N/A	N/A	N/A
8. Pressure Class	2500	2500	2500	2500
9. Temperature	-29°C to 120°C	-46°C to 150°C	-46°C to 150°C	-50°C to 150°C
10. Material Class	Carbon Steel	Duplex Steel	Duplex Steel	Duplex Steel
11. Body Material	ASTM A105 + Inconel 625 weld overlay (acc. item A.7.1.7.3)	ASTM A182 Gr F55	ASTM A182 Gr F55	ASTM A182 Gr F55
12. Obturator Material	AISI 316 + Inconel 625 weld overlay (acc. item A.7.1.7.3)	Super Duplex (UNS S32760)	Super Duplex (UNS S32760)	Super Duplex (UNS S32760) + Hard Coating (acc. Item A.7.1.7.4)
13. Seat Material	AISI 316 + Inconel 625 weld overlay (acc. item A.7.1.7.3)	Super Duplex (UNS S32760)	Super Duplex (UNS S32760)	Super Duplex (UNS S32760) + Hard Coating (acc. Item A.7.1.7.4)
14. Seat Insert	PEEK	PEEK	PEEK	N/A
15. Spring (Seat) Material	UNS N07750	UNS N07750	UNS N07750	UNS N07750
16. Stem Material	ASTM B637 (UNS N07718)	ASTM A276 (UNS S32760)	ASTM A276 (UNS S32760)	ASTM A276 (UNS S32760)
17. Seat-Stem Seal	Group B (acc. item A.7.1.5.6)	Group E (acc. item A.7.1.5.6)	Group E (acc. item A.7.1.5.6)	Group E (acc. item A.7.1.5.6)
18. Operator Type	Gearbox	Lever	Lever	Lever
19. Additional Requirement	Fire Tested (acc. item A.6.1.4)	Fire Tested (acc. item A.6.1.4)	Fire Tested (acc. item A.6.1.4)	Fire Tested (acc. item A.6.1.4)
20. Seat Type	Side A: SPE / Side B: SPE; DBB	Side A: SPE / Side B: SPE	Side A: SPE / Side B: SPE	Side A: SPE / Side B: SPE
21. Bore Type	Full Bore	Full Bore	Full Bore	Full Bore
22. Body Construction	Compact flangeless single body double ball valve. Face to face according ASME B16.10	One piece forged body	One piece forged body	One piece forged body
23. Cladding or Coating	Full clad - Inconel 625 weld overlay on all wetted parts	N/A	N/A	N/A
24. Valve Testing	FAT according A.9.3	FAT according A.9.3	FAT according A.9.3	FAT according A.9.3
25. Notes	All materials described in this datasheet are required for both valve, Needle valve between balls for cavity-pressure relief	Max weight 55kg, Minimum bore size 10mm, Needle valve between balls for cavity-pressure relief	Max weight 55kg, Minimum bore size 10mm, Needle valve between balls for cavity-pressure relief	Max weight 55kg, Minimum bore size 10mm, Needle valve between balls for cavity-pressure relief

Valve Code	VDE-2500-2-D315	VDE-2500-2-D370	VDE-2500-2-N103	VDE-2500-2-N104
Specs	H12P H12	H12P H12	H30P	H30P H30
1. Valve Type	Double Ball	Double Ball	Double Ball	Double Ball
2. Sealing Type	Soft	Metal to Metal	Soft	Soft
3. Valve Specification Level (VSL)	VSL-2	VSL-2	VSL-2	VSL-2
4. Ball Mouting	Trunnion	Trunnion	Trunnion	Trunnion
5. Standard	API 6D / IOGP S-562	API 6D / IOGP S-562	ASME B16.34	ASME B16.34
6. Size Range (NPS)	3" - 8"	3" - 8"	1" - 2"	1" - 2"
7. End Connection	ASME B16.5, RTJ	ASME B16.5, RTJ	N/A	N/A
8. Pressure Class	2500	2500	2500	2500
9. Temperature	-30°C to 120°C	-50°C to 200°C	-46°C to 150°C	-46°C to 150°C
10. Material Class	Duplex Steel	Duplex Steel	Nickel Alloys	Nickel Alloys
11. Body Material	ASTM A182 Gr F55	ASTM A182 Gr F55	ASTM B564 (UNS N06625)	ASTM B564 (UNS N06625)
12. Obturator Material	Super Duplex (UNS S32760)	Super Duplex (UNS S32760)	ASTM B564 (UNS N06625)	ASTM B564 (UNS N06625)
13. Seat Material	Super Duplex (UNS S32760)	Super Duplex (UNS S32760)	ASTM B564 (UNS N06625)	ASTM B564 (UNS N06625)
14. Seat Insert	PEEK	N/A	PEEK	PEEK
15. Spring (Seat) Material	UNS N07750	UNS N07750	UNS N07750	UNS N07750
16. Stem Material	ASTM A276 (UNS S32760)	ASTM A276 (UNS S32760)	ASTM B637 (UNS N07718)	ASTM B637 (UNS N07718)
17. Seat-Stem Seal	Group B (acc. item A.7.1.5.6)	Group E (acc. item A.7.1.5.6)	Group E (acc. item A.7.1.5.6)	Group E (acc. item A.7.1.5.6)
18. Operator Type	Gearbox	Gearbox	Lever	Lever
19. Additional Requirement	Fire Tested (acc. item A.6.1.4)	N/A	Fire Tested (acc. item A.6.1.4)	Fire Tested (acc. item A.6.1.4)
20. Seat Type	Side A: SPE / Side B: SPE; DBB	Side A: SPE / Side B: SPE	Side A: SPE / Side B: SPE	Side A: SPE / Side B: SPE
21. Bore Type	Full Bore	Full Bore	Full Bore	Full Bore
22. Body Construction	Compact flangeless single body double ball valve. Face to face according ASME B16.10	Compact flangeless single body double ball valve. Face to face according ASME B16.10	One piece forged body	One piece forged body
23. Cladding or Coating	N/A	N/A	N/A	N/A
24. Valve Testing	FAT according A.9.3	FAT according A.9.3	FAT according A.9.3	FAT according A.9.3
25. Notes	All materials described in this datasheet are required for both valve, Needle valve between balls for cavity-pressure relief	All materials described in this datasheet are required for both valve, Needle valve between balls for cavity-pressure relief	Max weight 55kg, Minimum bore size 10mm, Needle valve between balls for cavity-pressure relief	Max weight 55kg, Minimum bore size 10mm, Needle valve between balls for cavity-pressure relief

Valve Code	VDE-2500-2-S203	VDE-2500-2-S204	VDE-2500-2-S205	VDE-2500-2-S235
Specs	H3	H3	H3	H3
1. Valve Type	Double Ball	Double Ball	Double Ball	Double Ball
2. Sealing Type	Soft	Soft	Metal to Metal, Soft	Soft
3. Valve Specification Level (VSL)	VSL-2	VSL-2	VSL-2	VSL-2
4. Obturator Type	Trunnion	Trunnion	Trunnion	Trunnion
5. Standard	ASME B16.34	ASME B16.34	ASME B16.34	API 6D / IOGP S-562
6. Size Range (NPS)	1" - 2"	1" - 2"	1" - 2"	3" - 8"
7. End Connection	Flange ASME B16.5, RTJ	Flange ASME B16.5, RTJ x NPT 1/2" ASME B1.20.1	Flange ASME B16.5, RTJ	N/A
8. Pressure Class	2500	2500	2500	2500
9. Temperature	-46°C to 150°C	-46°C to 150°C	-100°C to 150°C	-46°C to 150°C
10. Material Class	Stainless Steel	Stainless Steel	Stainless Steel	Stainless Steel
11. Body Material	ASTM A182 Gr F316/316L	ASTM A182 Gr F316/316L	ASTM A182 Gr F316/316L	ASTM A182 Gr F316
12. Obturator Material	AISI 316	AISI 316	AISI 316	AISI 316
13. Seat Material	AISI 316	AISI 316	AISI 316	AISI 316
14. Seat Insert Material	PEEK	PEEK	PEEK	PEEK
15. Spring Material	UNS N07750	UNS N07750	UNS N07750	UNS N07750
16. Stem Material	ASTM B637 (UNS N07718)	ASTM B637 (UNS N07718)	ASTM B637 (UNS N07718)	ASTM A276 (UNS S32760)
17. Stem Seal Material	Group E (acc. item A.7.1.5.6)	Group E (acc. item A.7.1.5.6)	Group E (acc. item A.7.1.5.6)	Group E (acc. item A.7.1.5.6)
18. Operator Type	Lever	Lever	Lever	Gearbox
19. Additional Requirement	Fire Tested (acc. item A.6.1.4)	Fire Tested (acc. item A.6.1.4)	Fire Tested (acc. item A.6.1.4)	Fire Tested (acc. item A.6.1.4)
20. Seat Type	Side A: SPE / Side B: SPE	Side A: SPE / Side B: SPE	Side A: SPE / Side B: SPE	Side A: SPE / Side B: SPE; DBB
21. Bore Type	Full Bore	Full Bore	Full Bore	Full Bore
22. Body Construction	One piece forged body	One piece forged body	One piece forged body	Compact flangeless single body double ball valve. Face to face according ASME B16.10
23. Product Testing	FAT according A.9.3	FAT according A.9.3	FAT according A.9.3	FAT according A.9.3
24. Cladding or Coating	N/A	N/A	N/A	N/A
25. Notes	Needle valve between balls for cavity-pressure relief Max weight 55kg Minimum bore size 10mm	Needle valve between balls for cavity-pressure relief Max weight 55kg Minimum bore size 10mm	Needle valve between balls for cavity-pressure relief Max weight 55kg Minimum bore size 10mm	Needle valve between balls for cavity-pressure relief All materials described in this datasheet are required for both valve

Valve Code	VDE-2500-2-S270	VDE-2510-2-C115	VDE-2510-2-C215	VDE-2510-2-C235
Specs	H3	H10	H6	H6
1. Valve Type	Double Ball	Double Ball	Double Ball	Double Ball
2. Sealing Type	Metal to Metal	Soft	Soft	Soft
3. Valve Specification Level (VSL)	VSL-2	VSL-2	VSL-2	VSL-2
4. Ball Mouting	Trunnion	N/A	N/A	N/A
5. Standard	API 6D / IOGP S-562	API 6D / IOGP S-562	API 6D / IOGP S-562	API 6D / IOGP S-562
6. Size Range (NPS)	3" - 8"	3" - 8"	3" - 8"	3" - 8"
7. End Connection	ASME B16.5, RTJ	ISO 27509, IX	ISO 27509, IX	ISO 27509, IX
8. Pressure Class	2500	2500	2500	2500
9. Temperature	-100°C to 200°C	-29°C to 120°C	-30°C to 120°C	-46°C to 120°C
10. Material Class	Stainless Steel	Carbon Steel	Carbon Steel	Carbon Steel
11. Body Material	ASTM A182 Gr F316	ASTM A105 + SS316 weld overlay (acc. item A.7.1.7.3)	ASTM A350 Gr LF2 CL1 + SS316 weld overlay (acc. item A.7.1.7.3)	ASTM A350 Gr LF2 CL1 + Inconel 625 weld overlay (acc. item A.7.1.7.3)
12. Obturator Material	AISI 316	AISI 410	AISI 316	AISI 316
13. Seat Material	AISI 316	AISI 410	AISI 316	AISI 316
14. Seat Insert	N/A	PEEK	PEEK	PEEK
15. Spring (Seat) Material	UNS N07750	UNS N07750	UNS N07750	UNS N07750
16. Stem Material	ASTM B637 (UNS N07718)	ASTM A276 (UNS S41000)	ASTM B637 (UNS N07718)	ASTM B637 (UNS N07718)
17. Seat-Stem Seal	Group E (acc. item A.7.1.5.6)	Group B (acc. item A.7.1.5.6)	Group B (acc. item A.7.1.5.6)	Group E (acc. item A.7.1.5.6)
18. Operator Type	Gearbox	Gearbox	Gearbox	Gearbox
19. Additional Requirement	N/A	Fire Tested (acc. item A.6.1.4)	Fire Tested (acc. item A.6.1.4)	Fire Tested (acc. item A.6.1.4)
20. Seat Type	Side A: SPE / Side B: SPE	Side A: SPE / Side B: SPE; DBB	Side A: SPE / Side B: SPE; DBB	Side A: SPE / Side B: SPE; DBB
21. Bore Type	Full Bore	Full Bore	Full Bore	Full Bore
22. Body Construction	Compact flangeless single body double ball valve. Face to face according ASME B16.10	Compact flangeless single body double ball valve. Face to face according ASME B16.10	Compact flangeless single body double ball valve. Face to face according ASME B16.10	Compact flangeless single body double ball valve. Face to face according ASME B16.10
23. Cladding or Coating	N/A	Partial clad - SS316 weld overlay on all body sealing areas	Partial clad - SS316 weld overlay on all body sealing areas	Partial clad - Inconel 625 weld overlay on all body sealing areas
24. Valve Testing	FAT according A.9.3	FAT according A.9.3	FAT according A.9.3	FAT according A.9.3
25. Notes	All materials described in this datasheet are required for both valve, Needle valve between balls for cavity-pressure relief	All materials described in this datasheet are required for both valve, Needle valve between balls for cavity-pressure relief	All materials described in this datasheet are required for both valve, Needle valve between balls for cavity-pressure relief	All materials described in this datasheet are required for both valve, Needle valve between balls for cavity-pressure relief

Valve Code	VDE-2510-2-C271	VDE-2510-2-C515	VDE-2510-2-D315	VDE-2510-2-D370
Specs	H6	H30	H12P H12	H12P H12
1. Valve Type	Double Ball	Double Ball	Double Ball	Double Ball
2. Sealing Type	Metal to Metal	Soft	Soft	Metal to Metal
3. Valve Specification Level (VSL)	VSL-2	VSL-2	VSL-2	VSL-2
4. Ball Mouting	N/A	Trunnion	N/A	N/A
5. Standard	API 6D / IOGP S-562	API 6D / IOGP S-562	API 6D / IOGP S-562	API 6D / IOGP S-562
6. Size Range (NPS)	N/A	3" - 8"	3" - 8"	3" - 8"
7. End Connection	N/A	ISO 27509, IX	ISO 27509, IX	ISO 27509, IX
8. Pressure Class	2500	2500	2500	2500
9. Temperature	-46°C to 200°C	-29°C to 120°C	-30°C to 120°C	-50°C to 200°C
10. Material Class	Carbon Steel	Carbon Steel	Duplex Steel	Duplex Steel
11. Body Material	ASTM A350 Gr LF2 CL1 + Inconel 625 weld overlay (acc. item A.7.1.7.3)	ASTM A105 + Inconel 625 weld overlay (acc. item A.7.1.7.3)	ASTM A182 Gr F55	ASTM A182 Gr F55
12. Obturator Material	AISI 316	AISI 316 + Inconel 625 weld overlay (acc. item A.7.1.7.3)	Super Duplex (UNS S32760)	Super Duplex (UNS S32760)
13. Seat Material	AISI 316	AISI 316 + Inconel 625 weld overlay (acc. item A.7.1.7.3)	Super Duplex (UNS S32760)	Super Duplex (UNS S32760)
14. Seat Insert	N/A	PEEK	PEEK	N/A
15. Spring (Seat) Material	UNS N07750	UNS N07750	UNS N07750	UNS N07750
16. Stem Material	ASTM B637 (UNS N07718)	ASTM B637 (UNS N07718)	ASTM A276 (UNS S32760)	ASTM A276 (UNS S32760)
17. Seat-Stem Seal	Group E (acc. item A.7.1.5.6)	Group B (acc. item A.7.1.5.6)	Group B (acc. item A.7.1.5.6)	Group E (acc. item A.7.1.5.6)
18. Operator Type	Gearbox	Gearbox	Gearbox	Gearbox
19. Additional Requirement	Fire Tested (acc. item A.6.1.4)	Fire Tested (acc. item A.6.1.4)	Fire Tested (acc. item A.6.1.4)	N/A
20. Seat Type	Side A: SPE / Side B: SPE	Side A: SPE / Side B: SPE; DBB	Side A: SPE / Side B: SPE; DBB	Side A: SPE / Side B: SPE
21. Bore Type	Full Bore	Full Bore	Full Bore	Full Bore
22. Body Construction	Compact flangeless single body double ball valve. Face to face according ASME B16.10	Compact flangeless single body double ball valve. Face to face according ASME B16.10	Compact flangeless single body double ball valve. Face to face according ASME B16.10	Compact flangeless single body double ball valve. Face to face according ASME B16.10
23. Cladding or Coating	Partial clad - Inconel 625 weld overlay on all body sealing areas	Full clad - Inconel 625 weld overlay on all wetted parts	N/A	N/A
24. Valve Testing	FAT according A.9.3	FAT according A.9.3	FAT according A.9.3	FAT according A.9.3
25. Notes	Needle valve between balls for cavity-pressure relief, All materials described in this datasheet are required for both valve	All materials described in this datasheet are required for both valve, Needle valve between balls for cavity-pressure relief	All materials described in this datasheet are required for both valve, Needle valve between balls for cavity-pressure relief	All materials described in this datasheet are required for both valve, Needle valve between balls for cavity-pressure relief

Valve Code	VDE-2510-2-S235	VDE-300-2-C114	VDE-300-2-C115	VDE-300-2-C201
Specs	H3	C10	C10	C6 C10 C19
1. Valve Type	Double Ball	Double Ball	Double Ball	Double Ball
2. Sealing Type	Soft	Soft	Soft	Soft
3. Valve Specification Level (VSL)	VSL-2	VSL-2	VSL-2	VSL-2
4. Ball Mouting	N/A	N/A	N/A	Floating
5. Standard	API 6D / IOGP S-562	API 6D / IOGP S-562	API 6D / IOGP S-562	ASME B16.34
6. Size Range (NPS)	3" - 8"	3" - 8"	3" - 8"	½" - 2"
7. End Connection	ISO 27509, IX	ASME B16.5	ASME B16.5	N/A
8. Pressure Class	2500	300	300	300
9. Temperature	-46°C to 120°C	-29°C to 150°C	-29°C to 150°C	-30°C to 150°C
10. Material Class	Stainless Steel	Carbon Steel	Carbon Steel	Carbon Steel
11. Body Material	ASTM A182 Gr F316	ASTM A105 or ASTM A216 Gr WCB + SS316 weld overlay (acc. item A.7.1.7.3)	ASTM A105 or ASTM A216 Gr WCB + SS316 weld overlay (acc. item A.7.1.7.3)	ASTM A350 Gr LF2 CL1
12. Obturator Material	AISI 316	AISI 410	AISI 410	AISI 316
13. Seat Material	AISI 316	AISI 410	AISI 410	PTFE reinforced with 25% Carbon
14. Seat Insert	PEEK	PEEK	PEEK	N/A
15. Spring (Seat) Material	UNS N07750	UNS N07750	UNS N07750	N/A
16. Stem Material	ASTM A276 (UNS S32760)	ASTM A276 (UNS S41000)	ASTM A276 (UNS S41000)	ASTM A276 (UNS S31600)
17. Seat-Stem Seal	Group E (acc. item A.7.1.5.6)	Group B (acc. item A.7.1.5.6)	Group B (acc. item A.7.1.5.6)	Group B (acc. item A.7.1.5.6)
18. Operator Type	Gearbox	N/A	N/A	Lever
19. Additional Requirement	Fire Tested (acc. item A.6.1.4)	N/A	Fire Tested (acc. item A.6.1.4)	Fire Tested (acc. item A.6.1.4)
20. Seat Type	Side A: SPE / Side B: SPE; DBB	Side A: SPE / Side B: SPE; DBB	Side A: SPE / Side B: SPE; DBB	N/A
21. Bore Type	Full Bore	Full Bore	Full Bore	Full Bore
22. Body Construction	Compact flangeless single body double ball valve. Face to face according ASME B16.10	Compact flangeless single body double ball valve. Face to face according ASME B16.10	Compact flangeless single body double ball valve. Face to face according ASME B16.10	One piece forged body
23. Cladding or Coating	N/A	Partial clad - SS316 weld overlay on all body sealing areas	Partial clad - SS316 weld overlay on all body sealing areas	N/A
24. Valve Testing	FAT according A.9.3	FAT according A.9.3	FAT according A.9.3	FAT according A.9.3
25. Notes	All materials described in this datasheet are required for both valve, Needle valve between balls for cavity-pressure relief	All materials described in this datasheet are required for both valve, Needle valve between balls for cavity-pressure relief	All materials described in this datasheet are required for both valve, Needle valve between balls for cavity-pressure relief	Max weight 55kg, Minimum bore size 10mm, Needle valve between balls for cavity-pressure relief

Valve Code	VDE-300-2-C202	VDE-300-2-C205	VDE-300-2-C206	VDE-300-2-C215
Specs	C6 C10 C19	C6 C10 C19	C6 C10 C19	C6 C19
1. Valve Type	Double Ball	Double Ball	Double Ball	Double Ball
2. Sealing Type	Soft	Metal to Metal	Metal to Metal	Soft
3. Valve Specification Level (VSL)	VSL-2	VSL-2	VSL-2	VSL-2
4. Obturator Type	Floating	Floating	Floating	N/A
5. Standard	ASME B16.34	ASME B16.34	ASME B16.34	API 6D / IOGP S-562
6. Size Range (NPS)	½" - 2"	½" - 2"	½" - 2"	3" - 8"
7. End Connection	Flange ASME B16.5, RF x NPT 1/2" ASME B1.20.1	Flange ASME B16.5, RF	Flange ASME B16.5, RF x NPT 1/2" ASME B1.20.1	N/A
8. Pressure Class	300	300	300	300
9. Temperature	-30°C to 150°C	-46°C to 200°C	-46°C to 200°C	-30°C to 150°C
10. Material Class	Carbon Steel	Carbon Steel	Carbon Steel	Carbon Steel
11. Body Material	ASTM A350 Gr LF2 CL1	ASTM A350 Gr LF2 CL1	ASTM A350 Gr LF2 CL1	ASTM A350 Gr LF2 CL1 or ASTM A352 Gr LCB
12. Obturator Material	AISI 316	AISI 316 + Hard Coating (acc. Item A.7.1.7.4)	AISI 316 + Hard Coating (acc. Item A.7.1.7.4)	AISI 316
13. Seat Material	PTFE reinforced with 25% Carbon	AISI 316 + Hard Coating (acc. Item A.7.1.7.4)	AISI 316 + Hard Coating (acc. Item A.7.1.7.4)	AISI 410
14. Seat Insert Material	N/A	N/A	N/A	PEEK
15. Spring Material	N/A	N/A	N/A	UNS N07750
16. Stem Material	ASTM A276 (UNS S31600)	ASTM A276 (UNS S31600)	ASTM A276 (UNS S31600)	ASTM A276 (UNS S31600)
17. Stem Seal Material	Group B (acc. item A.7.1.5.6)	Group E (acc. item A.7.1.5.6)	Group E (acc. item A.7.1.5.6)	Group B (acc. item A.7.1.5.6)
18. Operator Type	Lever	Lever	Lever	N/A
19. Additional Requirement	Fire Tested (acc. item A.6.1.4)	Fire Tested (acc. item A.6.1.4)	Fire Tested (acc. item A.6.1.4)	Fire Tested (acc. item A.6.1.4)
20. Seat Type	N/A	N/A	N/A	Side A: SPE / Side B: SPE; DBB
21. Bore Type	Full Bore	Full Bore	Full Bore	Full Bore
22. Body Construction	One piece forged body	One piece forged body	One piece forged body	Compact flangeless single body double ball valve. Face to face according ASME B16.10
23. Product Testing	FAT according A.9.3	FAT according A.9.3	FAT according A.9.3	FAT according A.9.3
24. Cladding or Coating	N/A	N/A	N/A	Partial clad - SS316 weld overlay on all body sealing areas
25. Notes	Needle valve between balls for cavity-pressure relief Max weight 55kg Minimum bore size 10mm	Needle valve between balls for cavity-pressure relief Max weight 55kg Minimum bore size 10mm	Needle valve between balls for cavity-pressure relief Max weight 55kg Minimum bore size 10mm	Needle valve between balls for cavity-pressure relief All materials described in this datasheet are required for both valve

Valve Code	VDE-300-2-C514	VDE-300-2-D201	VDE-300-2-D202	VDE-300-2-D203
Specs	C30	C16	C16	C16
1. Valve Type	Double Ball	Double Ball	Double Ball	Double Ball
2. Sealing Type	Soft	Soft	Soft	Soft
3. Valve Specification Level (VSL)	VSL-2	VSL-2	VSL-2	VSL-2
4. Ball Mouting	Trunnion	N/A	N/A	N/A
5. Standard	API 6D / IOGP S-562	ASME B16.34	ASME B16.34	ASME B16.34
6. Size Range (NPS)	3" - 8"	½" - 2"	½" - 2"	½" - 2"
7. End Connection	ASME B16.5, RF	N/A	N/A	N/A
8. Pressure Class	300	300	300	300
9. Temperature	-29°C to 150°C	-30°C to 150°C	-30°C to 150°C	-46°C to 150°C
10. Material Class	Carbon Steel	Duplex Steel	Duplex Steel	Duplex Steel
11. Body Material	ASTM A105 or ASTM A216 Gr WCB + Inconel 625 weld overlay (acc. item A.7.1.7.3)	ASTM A182 Gr F51	ASTM A182 Gr F51	ASTM A182 Gr F51
12. Obturator Material	AISI 316 + Inconel 625 weld overlay (acc. item A.7.1.7.3)	Duplex (UNS S31803)	Duplex (UNS S31803)	Duplex (UNS S31803)
13. Seat Material	AISI 316 + Inconel 625 weld overlay (acc. item A.7.1.7.3)	PTFE reinforced with 25% Carbon	PTFE reinforced with 25% Carbon	PTFE reinforced with 25% Carbon
14. Seat Insert	PEEK	N/A	N/A	N/A
15. Spring (Seat) Material	UNS N07750	N/A	N/A	N/A
16. Stem Material	ASTM B637 (UNS N07718)	ASTM A276 (UNS S31803)	ASTM A276 (UNS S31803)	ASTM A276 (UNS S31803)
17. Seat-Stem Seal	Group B (acc. item A.7.1.5.6)	Group B (acc. item A.7.1.5.6)	Group B (acc. item A.7.1.5.6)	Group E (acc. item A.7.1.5.6)
18. Operator Type	3" Lever	N/A	N/A	N/A
	4" - 8" Gearbox	N/A	N/A	N/A
19. Additional Requirement	N/A	Fire Tested (acc. item A.6.1.4)	Fire Tested (acc. item A.6.1.4)	Fire Tested (acc. item A.6.1.4)
20. Seat Type	Side A: SPE / Side B: SPE; DBB	N/A	N/A	N/A
21. Bore Type	Full Bore	Full Bore	Full Bore	Full Bore
22. Body Construction	Compact flangeless single body double ball valve. Face to face according ASME B16.10	One piece forged body	One piece forged body	One piece forged body
23. Cladding or Coating	Full clad - Inconel 625 weld overlay on all wetted parts	N/A	N/A	N/A
24. Valve Testing	FAT according A.9.3	FAT according A.9.3	FAT according A.9.3	FAT according A.9.3
25. Notes	All materials described in this datasheet are required for both valve, Needle valve between balls for cavity-pressure relief	Max weight 55kg, Minimum bore size 10mm, Needle valve between balls for cavity-pressure relief	Max weight 55kg, Minimum bore size 10mm, Needle valve between balls for cavity-pressure relief	Max weight 55kg, Minimum bore size 10mm, Needle valve between balls for cavity-pressure relief

Valve Code	VDE-300-2-D204	VDE-300-2-D301	VDE-300-2-D302	VDE-300-2-D303
Specs	C16	C12	C12	C12
1. Valve Type	Double Ball	Double Ball	Double Ball	Double Ball
2. Sealing Type	Soft	Soft	Soft	Soft
3. Valve Specification Level (VSL)	VSL-2	VSL-2	VSL-2	VSL-2
4. Obturator Type	Floating	Floating	Floating	Floating
5. Standard	ASME B16.34	ASME B16.34	ASME B16.34	ASME B16.34
6. Size Range (NPS)	½" - 2"	½" - 2"	½" - 2"	½" - 2"
7. End Connection	Flange ASME B16.5, RF x NPT 1/2" ASME B1.20.1	Flange ASME B16.5, RF	Flange ASME B16.5, RF x NPT 1/2" ASME B1.20.1	Flange ASME B16.5, RF
8. Pressure Class	300	300	300	300
9. Temperature	-46°C to 150°C	-30°C to 150°C	-30°C to 150°C	-46°C to 150°C
10. Material Class	Duplex Steel	Duplex Steel	Duplex Steel	Duplex Steel
11. Body Material	ASTM A182 Gr F51	ASTM A182 Gr F55	ASTM A182 Gr F55	ASTM A182 Gr F55
12. Obturator Material	Duplex (UNS S31803)	Super Duplex (UNS S32760)	Super Duplex (UNS S32760)	Super Duplex (UNS S32760)
13. Seat Material	PTFE reinforced with 25% Carbon	PTFE reinforced with 25% Carbon	PTFE reinforced with 25% Carbon	PTFE reinforced with 25% Carbon
14. Seat Insert Material	N/A	N/A	N/A	N/A
15. Spring Material	N/A	N/A	N/A	N/A
16. Stem Material	ASTM A276 (UNS S31803)	ASTM A276 (UNS S32760)	ASTM A276 (UNS S32760)	ASTM A276 (UNS S32760)
17. Stem Seal Material	Group E (acc. item A.7.1.5.6)	Group B (acc. item A.7.1.5.6)	Group B (acc. item A.7.1.5.6)	Group E (acc. item A.7.1.5.6)
18. Operator Type	Lever	Lever	Lever	Lever
19. Additional Requirement	Fire Tested (acc. item A.6.1.4)	Fire Tested (acc. item A.6.1.4)	Fire Tested (acc. item A.6.1.4)	Fire Tested (acc. item A.6.1.4)
20. Seat Type	N/A	N/A	N/A	N/A
21. Bore Type	Full Bore	Full Bore	Full Bore	Full Bore
22. Body Construction	One piece forged body	One piece forged body	One piece forged body	One piece forged body
23. Product Testing	FAT according A.9.3	FAT according A.9.3	FAT according A.9.3	FAT according A.9.3
24. Cladding or Coating	N/A	N/A	N/A	N/A
25. Notes	Needle valve between balls for cavity-pressure relief Max weight 55kg Minimum bore size 10mm	Needle valve between balls for cavity-pressure relief Max weight 55kg Minimum bore size 10mm	Needle valve between balls for cavity-pressure relief Max weight 55kg Minimum bore size 10mm	Needle valve between balls for cavity-pressure relief Max weight 55kg Minimum bore size 10mm

Valve Code	VDE-300-2-D304	VDE-300-2-D334	VDE-300-2-N101	VDE-300-2-N102
Specs	C12	C12	C30	C30
1. Valve Type	Double Ball	Double Ball	Double Ball	Double Ball
2. Sealing Type	Soft	Soft	Soft	Soft
3. Valve Specification Level (VSL)	VSL-2	VSL-2	VSL-2	VSL-2
4. Obturator Type	Floating	N/A	Floating	Floating
5. Standard	ASME B16.34	API 6D / IOGP S-562	ASME B16.34	ASME B16.34
6. Size Range (NPS)	½" - 2"	3" - 8"	½" - 2"	½" - 2"
7. End Connection	Flange ASME B16.5, RF x NPT 1/2" ASME B1.20.1	N/A	Flange ASME B16.5, RF	Flange ASME B16.5, RF x NPT 1/2" ASME B1.20.1
8. Pressure Class	300	300	300	300
9. Temperature	-46°C to 150°C	-46°C to 150°C	-30°C to 150°C	-30°C to 150°C
10. Material Class	Duplex Steel	Duplex Steel	Nickel Alloys	Nickel Alloys
11. Body Material	ASTM A182 Gr F55	ASTM A182 Gr F55 or ASTM A995 Gr 6a	ASTM B564 (UNS N06625)	ASTM B564 (UNS N06625)
12. Obturator Material	Super Duplex (UNS S32760)	Super Duplex (UNS S32760)	ASTM B564 (UNS N06625)	ASTM B564 (UNS N06625)
13. Seat Material	PTFE reinforced with 25% Carbon	Duplex (UNS S31803)	PTFE reinforced with 25% Carbon	PTFE reinforced with 25% Carbon
14. Seat Insert Material	N/A	PEEK	N/A	N/A
15. Spring Material	N/A	UNS N07750	N/A	N/A
16. Stem Material	ASTM A276 (UNS S32760)	ASTM A276 (UNS S32760)	ASTM B637 (UNS N07718)	ASTM B637 (UNS N07718)
17. Stem Seal Material	Group E (acc. item A.7.1.5.6)	Group E (acc. item A.7.1.5.6)	Group B (acc. item A.7.1.5.6)	Group B (acc. item A.7.1.5.6)
18. Operator Type	Lever	N/A	Lever	Lever
19. Additional Requirement	Fire Tested (acc. item A.6.1.4)	N/A	Fire Tested (acc. item A.6.1.4)	Fire Tested (acc. item A.6.1.4)
20. Seat Type	N/A	Side A: SPE / Side B: SPE; DBB	N/A	N/A
21. Bore Type	Full Bore	Full Bore	Full Bore	Full Bore
22. Body Construction	One piece forged body	Compact flangeless single body double ball valve. Face to face according ASME B16.10	One piece forged body	One piece forged body
23. Product Testing	FAT according A.9.3	FAT according A.9.3	FAT according A.9.3	FAT according A.9.3
24. Cladding or Coating	N/A	N/A	N/A	N/A
25. Notes	Needle valve between balls for cavity-pressure relief Max weight 55kg Minimum bore size 10mm	Needle valve between balls for cavity-pressure relief All materials described in this datasheet are required for both valve	Needle valve between balls for cavity-pressure relief Max weight 55kg Minimum bore size 10mm	Needle valve between balls for cavity-pressure relief Max weight 55kg Minimum bore size 10mm

Valve Code	VDE-300-2-N105	VDE-300-2-N106	VDE-300-2-S201	VDE-300-2-S202
Specs	C30	C30	C3	C3
1. Valve Type	Double Ball	Double Ball	Double Ball	Double Ball
2. Sealing Type	Metal to Metal	Metal to Metal	Soft	Soft
3. Valve Specification Level (VSL)	VSL-2	VSL-2	VSL-2	VSL-2
4. Obturator Type	Floating	Floating	Floating	Floating
5. Standard	ASME B16.34	ASME B16.34	ASME B16.34	ASME B16.34
6. Size Range (NPS)	½" - 2"	½" - 2"	½" - 2"	½" - 2"
7. End Connection	Flange ASME B16.5, RF	Flange ASME B16.5, RF x NPT 1/2" ASME B1.20.1	Flange ASME B16.5, RF	Flange ASME B16.5, RF x NPT 1/2" ASME B1.20.1
8. Pressure Class	300	300	300	300
9. Temperature	-100°C to 200°C	-100°C to 200°C	-30°C to 150°C	-30°C to 150°C
10. Material Class	Nickel Alloys	Nickel Alloys	Stainless Steel	Stainless Steel
11. Body Material	ASTM B564 (UNS N06625)	ASTM B564 (UNS N06625)	ASTM A182 Gr F316	ASTM A182 Gr F316
12. Obturator Material	ASTM B564 (UNS N06625)	ASTM B564 (UNS N06625)	AISI 316	AISI 316
13. Seat Material	ASTM B564 (UNS N06625)	ASTM B564 (UNS N06625)	PTFE reinforced with 25% Carbon	PTFE reinforced with 25% Carbon
14. Seat Insert Material	N/A	N/A	N/A	N/A
15. Spring Material	N/A	N/A	N/A	N/A
16. Stem Material	ASTM B637 (UNS N07718)	ASTM B637 (UNS N07718)	ASTM A276 (UNS S31600)	ASTM A276 (UNS S31600)
17. Stem Seal Material	Group E (acc. item A.7.1.5.6)	Group E (acc. item A.7.1.5.6)	Group B (acc. item A.7.1.5.6)	Group B (acc. item A.7.1.5.6)
18. Operator Type	Lever	Lever	Lever	Lever
19. Additional Requirement	Fire Tested (acc. item A.6.1.4)	Fire Tested (acc. item A.6.1.4)	Fire Tested (acc. item A.6.1.4)	Fire Tested (acc. item A.6.1.4)
20. Seat Type	N/A	N/A	N/A	N/A
21. Bore Type	Full Bore	Full Bore	Full Bore	Full Bore
22. Body Construction	One piece forged body	One piece forged body	One piece forged body	One piece forged body
23. Product Testing	FAT according A.9.3	FAT according A.9.3	FAT according A.9.3	FAT according A.9.3
24. Cladding or Coating	N/A	N/A	N/A	N/A
25. Notes	Needle valve between balls for cavity-pressure relief Max weight 55kg Minimum bore size 10mm	Needle valve between balls for cavity-pressure relief Max weight 55kg Minimum bore size 10mm	Needle valve between balls for cavity-pressure relief Max weight 55kg Minimum bore size 10mm	Needle valve between balls for cavity-pressure relief Max weight 55kg Minimum bore size 10mm

Valve Code	VDE-300-2-S203	VDE-300-2-S204	VDE-300-2-S205	VDE-300-2-S206
Specs	C3	C3	C3	C3
1. Valve Type	Double Ball	Double Ball	Double Ball	Double Ball
2. Sealing Type	Soft	Soft	Metal to Metal	Metal to Metal
3. Valve Specification Level (VSL)	VSL-2	VSL-2	VSL-2	VSL-2
4. Obturator Type	Floating	Floating	Floating	Floating
5. Standard	ASME B16.34	ASME B16.34	ASME B16.34	ASME B16.34
6. Size Range (NPS)	½" - 2"	½" - 2"	½" - 2"	½" - 2"
7. End Connection	Flange ASME B16.5, RF	Flange ASME B16.5, RF x NPT 1/2" ASME B1.20.1	Flange ASME B16.5, RF	Flange ASME B16.5, RF x NPT 1/2" ASME B1.20.1
8. Pressure Class	300	300	300	300
9. Temperature	-100°C to 150°C	-100°C to 150°C	-100°C to 200°C	-100°C to 200°C
10. Material Class	Stainless Steel	Stainless Steel	Stainless Steel	Stainless Steel
11. Body Material	ASTM A182 Gr F316	ASTM A182 Gr F316	ASTM A182 Gr F316	ASTM A182 Gr F316
12. Obturator Material	AISI 316	AISI 316	AISI 316	AISI 316
13. Seat Material	PTFE reinforced with 25% Carbon	PTFE reinforced with 25% Carbon	AISI 316	AISI 316
14. Seat Insert Material	N/A	N/A	N/A	N/A
15. Spring Material	N/A	N/A	N/A	N/A
16. Stem Material	ASTM A276 (UNS S31600)	ASTM A276 (UNS S31600)	ASTM A276 (UNS S31600)	ASTM A276 (UNS S31600)
17. Stem Seal Material	Group E (acc. item A.7.1.5.6)	Group E (acc. item A.7.1.5.6)	Group E (acc. item A.7.1.5.6)	Group E (acc. item A.7.1.5.6)
18. Operator Type	Lever	Lever	Lever	Lever
19. Additional Requirement	Fire Tested (acc. item A.6.1.4)	Fire Tested (acc. item A.6.1.4)	Fire Tested (acc. item A.6.1.4)	Fire Tested (acc. item A.6.1.4)
20. Seat Type	N/A	N/A	N/A	N/A
21. Bore Type	Full Bore	Full Bore	Full Bore	Full Bore
22. Body Construction	One piece forged body	One piece forged body	One piece forged body	One piece forged body
23. Product Testing	FAT according A.9.3	FAT according A.9.3	FAT according A.9.3	FAT according A.9.3
24. Cladding or Coating	N/A	N/A	N/A	N/A
25. Notes	Needle valve between balls for cavity-pressure relief Max weight 55kg Minimum bore size 10mm	Needle valve between balls for cavity-pressure relief Max weight 55kg Minimum bore size 10mm	Needle valve between balls for cavity-pressure relief Max weight 55kg Minimum bore size 10mm	Needle valve between balls for cavity-pressure relief Max weight 55kg Minimum bore size 10mm

Valve Code	VDE-300-2-S207	VDE-300-2-S208	VDE-300-2-S234	VDE-600-2-A515
Specs	C3	C3	C3	E32
1. Valve Type	Double Ball	Double Ball	Double Ball	Double Ball
2. Sealing Type	Metal to Metal	Metal to Metal	Soft	Soft
3. Valve Specification Level (VSL)	VSL-2	VSL-2	VSL-2	VSL-2
4. Obturator Type	Floating	Floating	N/A	N/A
5. Standard	ASME B16.34	ASME B16.34	API 6D / IOGP S-562	API 6D / IOGP S-562
6. Size Range (NPS)	½" - 2"	½" - 2"	3" - 8"	3" - 8"
7. End Connection	Flange ASME B16.5, RF	Flange ASME B16.5, RF x NPT 1/2" ASME B1.20.1	N/A	N/A
8. Pressure Class	300	300	300	600
9. Temperature	-100°C to 340°C	-100°C to 340°C	-46°C to 150°C	-30°C to 150°C
10. Material Class	Stainless Steel	Stainless Steel	Stainless Steel	Alloy Steel
11. Body Material	ASTM A182 Gr F316	ASTM A182 Gr F316	ASTM A182 Gr F316 or ASTM A351 Gr CF8M	ASTM A350 Gr LF3 or ASTM A352 Gr LC3
12. Obturator Material	AISI 316	AISI 316	AISI 316	ASTM A350 Gr LF3
13. Seat Material	AISI 316	AISI 316	AISI 316	ASTM A350 Gr LF3
14. Seat Insert Material	N/A	N/A	PEEK	PEEK
15. Spring Material	N/A	N/A	UNS N07750	UNS N07750
16. Stem Material	ASTM A276 (UNS S31600)	ASTM A276 (UNS S31600)	ASTM A276 (UNS S31600)	ASTM B637 (UNS N07718)
17. Stem Seal Material	Group F (acc. item A.7.1.5.6)	Group F (acc. item A.7.1.5.6)	Group E (acc. item A.7.1.5.6)	Group B (acc. item A.7.1.5.6)
18. Operator Type	Lever	Lever	N/A	N/A
19. Additional Requirement	Fire Tested (acc. item A.6.1.4)	Fire Tested (acc. item A.6.1.4)	N/A	Fire Tested (acc. item A.6.1.4)
20. Seat Type	N/A	N/A	Side A: SPE / Side B: SPE; DBB	Side A: SPE / Side B: SPE; DBB
21. Bore Type	Full Bore	Full Bore	Full Bore	Full Bore
22. Body Construction	One piece forged body	One piece forged body	Compact flangeless single body double ball valve. Face to face according ASME B16.10	Compact flangeless single body double ball valve. Face to face according ASME B16.10
23. Product Testing	FAT according A.9.3	FAT according A.9.3	FAT according A.9.3	FAT according A.9.3
24. Cladding or Coating	N/A	N/A	Partial clad - Inconel 625 weld overlay on all body sealing areas	Full clad - Inconel 625 weld overlay on all wetted parts
25. Notes	Needle valve between balls for cavity-pressure relief Max weight 55kg Minimum bore size 10mm	Needle valve between balls for cavity-pressure relief Max weight 55kg Minimum bore size 10mm	Needle valve between balls for cavity-pressure relief All materials described in this datasheet are required for both valve	Needle valve between balls for cavity-pressure relief All materials described in this datasheet are required for both valve

Valve Code	VDE-600-2-A571		VDE-600-2-A581		VDE-600-2-C114		VDE-600-2-C115	
Specs	E32		E32		E9 E10		E9 E10	
1. Valve Type	Double Ball		Double Ball		Double Ball		Double Ball	
2. Sealing Type	Metal to Metal		Metal to Metal		Soft		Soft	
3. Valve Specification Level (VSL)	VSL-2		VSL-2		VSL-2		VSL-2	
4. Ball Mouting	Trunnion		Trunnion		Trunnion		Trunnion	
5. Standard	API 6D / IOGP S-562		API 6D / IOGP S-562		API 6D / IOGP S-562		API 6D / IOGP S-562	
6. Size Range (NPS)	3" - 8"		3" - 8"		3" - 8"		3" - 8"	
7. End Connection	ASME B16.5, RF		ASME B16.5, RF		ASME B16.5, RF		ASME B16.5, RF	
8. Pressure Class	600		600		600		600	
9. Temperature	-46°C to 200°C		-100°C to 340°C		-29°C to 150°C		-29°C to 150°C	
10. Material Class	Alloy Steel		Alloy Steel		Carbon Steel		Carbon Steel	
11. Body Material	ASTM A350 Gr LF3 or ASTM A352 Gr LC3 + Inconel 625 weld overlay (acc. item A.7.1.7.3)		ASTM A350 Gr LF3 or ASTM A352 Gr LC3 + Inconel 625 weld overlay (acc. item A.7.1.7.3)		ASTM A105 or ASTM A216 Gr WCB + SS316 weld overlay (acc. item A.7.1.7.3)		ASTM A105 or ASTM A216 Gr WCB + SS316 weld overlay (acc. item A.7.1.7.3)	
12. Obturator Material	ASTM A350 Gr LF3 + Inconel 625 weld overlay (acc. item A.7.1.7.3)		ASTM A350 Gr LF3 + Inconel 625 weld overlay (acc. item A.7.1.7.3)		AISI 410		AISI 410	
13. Seat Material	ASTM A350 Gr LF3 + Inconel 625 weld overlay (acc. item A.7.1.7.3)		ASTM A350 Gr LF3 + Inconel 625 weld overlay (acc. item A.7.1.7.3)		AISI 410		AISI 410	
14. Seat Insert	N/A		N/A		PEEK		PEEK	
15. Spring (Seat) Material	UNS N07750		UNS N07750		UNS N07750		UNS N07750	
16. Stem Material	ASTM B637 (UNS N07718)		ASTM B637 (UNS N07718)		ASTM A276 (UNS S41000)		ASTM A276 (UNS S41000)	
17. Seat-Stem Seal	Group E (acc. item A.7.1.5.6)		Group F (acc. item A.7.1.5.6)		Group B (acc. item A.7.1.5.6)		Group B (acc. item A.7.1.5.6)	
18. Operator Type	3"	Lever	3"	Lever	3"	Lever	3"	Lever
	4" - 8"	Gearbox	4" - 8"	Gearbox	4" - 8"	Gearbox	4" - 8"	Gearbox
19. Additional Requirement	Fire Tested (acc. item A.6.1.4)		Fire Tested (acc. item A.6.1.4)		N/A		Fire Tested (acc. item A.6.1.4)	
20. Seat Type	Side A: SPE / Side B: SPE		Side A: SPE / Side B: SPE		Side A: SPE / Side B: SPE; DBB		Side A: SPE / Side B: SPE; DBB	
21. Bore Type	Full Bore		Full Bore		Full Bore		Full Bore	
22. Body Construction	Compact flangeless single body double ball valve. Face to face according ASME B16.10		Compact flangeless single body double ball valve. Face to face according ASME B16.10		Compact flangeless single body double ball valve. Face to face according ASME B16.10		Compact flangeless single body double ball valve. Face to face according ASME B16.10	
23. Cladding or Coating	Full clad - Inconel 625 weld overlay on all wetted parts		Full clad - Inconel 625 weld overlay on all wetted parts		Partial clad - SS316 weld overlay on all body sealing areas		Partial clad - SS316 weld overlay on all body sealing areas	
24. Valve Testing	FAT according A.9.3		FAT according A.9.3		FAT according A.9.3		FAT according A.9.3	
25. Notes	All materials described in this datasheet are required for both valve, Needle valve between balls for cavity-pressure relief		All materials described in this datasheet are required for both valve, Needle valve between balls for cavity-pressure relief		All materials described in this datasheet are required for both valve, Needle valve between balls for cavity-pressure relief		All materials described in this datasheet are required for both valve, Needle valve between balls for cavity-pressure relief	

Valve Code	VDE-600-2-C124		VDE-600-2-C125		VDE-600-2-C134		VDE-600-2-C135	
Specs	E10		E10		E9 E10		E9 E10	
1. Valve Type	Double Ball		Double Ball		Double Ball		Double Ball	
2. Sealing Type	Soft		Soft		Soft		Soft	
3. Valve Specification Level (VSL)	VSL-2		VSL-2		VSL-2		VSL-2	
4. Ball Mouting	Trunnion		Trunnion		Trunnion		Trunnion	
5. Standard	API 6D / IOGP S-562		API 6D / IOGP S-562		API 6D / IOGP S-562		API 6D / IOGP S-562	
6. Size Range (NPS)	3" - 8"		3" - 8"		3" - 8"		3" - 8"	
7. End Connection	ASME B16.5, RF		ASME B16.5, RF		ASME B16.5, RF		ASME B16.5, RF	
8. Pressure Class	600		600		600		600	
9. Temperature	0°C to 150°C		0°C to 150°C		0°C to 150°C		0°C to 150°C	
10. Material Class	Carbon Steel		Carbon Steel		Carbon Steel		Carbon Steel	
11. Body Material	ASTM A105 or ASTM A216 Gr WCB + SS316 weld overlay (acc. item A.7.1.7.3)		ASTM A105 or ASTM A216 Gr WCB + SS316 weld overlay (acc. item A.7.1.7.3)		ASTM A105 or ASTM A216 Gr WCB + SS316 weld overlay (acc. item A.7.1.7.3)		ASTM A105 or ASTM A216 Gr WCB + SS316 weld overlay (acc. item A.7.1.7.3)	
12. Obturator Material	AISI 410		AISI 410		AISI 410		AISI 410	
13. Seat Material	AISI 410		AISI 410		AISI 410		AISI 410	
14. Seat Insert	PEEK		PEEK		PEEK		PEEK	
15. Spring (Seat) Material	UNS N07750		UNS N07750		UNS N07750		UNS N07750	
16. Stem Material	ASTM A276 (UNS S41000)		ASTM A276 (UNS S41000)		ASTM A276 (UNS S41000)		ASTM A276 (UNS S41000)	
17. Seat-Stem Seal	Group C (acc. item A.7.1.5.6)		Group C (acc. item A.7.1.5.6)		Group D (acc. item A.7.1.5.6)		Group D (acc. item A.7.1.5.6)	
18. Operator Type	3"	Lever	3"	Lever	3"	Lever	3"	Lever
	4" - 8"	Gearbox	4" - 8"	Gearbox	4" - 8"	Gearbox	4" - 8"	Gearbox
19. Additional Requirement	N/A		Fire Tested (acc. item A.6.1.4)		N/A		Fire Tested (acc. item A.6.1.4)	
20. Seat Type	Side A: SPE / Side B: SPE; DBB		Side A: SPE / Side B: SPE; DBB		Side A: SPE / Side B: SPE; DBB		Side A: SPE / Side B: SPE; DBB	
21. Bore Type	Full Bore		Full Bore		Full Bore		Full Bore	
22. Body Construction	Compact flangeless single body double ball valve. Face to face according ASME B16.10		Compact flangeless single body double ball valve. Face to face according ASME B16.10		Compact flangeless single body double ball valve. Face to face according ASME B16.10		Compact flangeless single body double ball valve. Face to face according ASME B16.10	
23. Cladding or Coating	Partial clad - SS316 weld overlay on all body sealing areas		Partial clad - SS316 weld overlay on all body sealing areas		Partial clad - SS316 weld overlay on all body sealing areas		Partial clad - SS316 weld overlay on all body sealing areas	
24. Valve Testing	FAT according A.9.3		FAT according A.9.3		FAT according A.9.3		FAT according A.9.3	
25. Notes	All materials described in this datasheet are required for both valve, Needle valve between balls for cavity-pressure relief		All materials described in this datasheet are required for both valve, Needle valve between balls for cavity-pressure relief		All materials described in this datasheet are required for both valve, Needle valve between balls for cavity-pressure relief		All materials described in this datasheet are required for both valve, Needle valve between balls for cavity-pressure relief	

Valve Code	VDE-600-2-C201	VDE-600-2-C202	VDE-600-2-C203	VDE-600-2-C204
Specs	E6 E9 E10 E19	E6 E9 E10 E19	E6 E9 E10 E19	E6 E9 E10 E19
1. Valve Type	Double Ball	Double Ball	Double Ball	Double Ball
2. Sealing Type	Soft	Soft	Soft	Soft
3. Valve Specification Level (VSL)	VSL-2	VSL-2	VSL-2	VSL-2
4. Obturator Type	Floating	Floating	Floating	Floating
5. Standard	ASME B16.34	ASME B16.34	ASME B16.34	ASME B16.34
6. Size Range (NPS)	½" - 2"	½" - 2"	½" - 2"	½" - 2"
7. End Connection	Flange ASME B16.5, RF	Flange ASME B16.5, RF x NPT 1/2" ASME B1.20.1	Flange ASME B16.5, RF	Flange ASME B16.5, RF x NPT 1/2" ASME B1.20.1
8. Pressure Class	600	600	600	600
9. Temperature	-30°C to 150°C	-30°C to 150°C	-46°C to 150°C	-46°C to 150°C
10. Material Class	Carbon Steel	Carbon Steel	Carbon Steel	Carbon Steel
11. Body Material	ASTM A350 Gr LF2 CL1	ASTM A350 Gr LF2 CL1	ASTM A350 Gr LF2 CL1	ASTM A350 Gr LF2 CL1
12. Obturator Material	AISI 316	AISI 316	AISI 316	AISI 316
13. Seat Material	PEEK	PEEK	PEEK	PEEK
14. Seat Insert Material	N/A	N/A	N/A	N/A
15. Spring Material	N/A	N/A	N/A	N/A
16. Stem Material	ASTM A276 (UNS S31600)	ASTM A276 (UNS S31600)	ASTM A276 (UNS S31600)	ASTM A276 (UNS S31600)
17. Stem Seal Material	Group B (acc. item A.7.1.5.6)	Group B (acc. item A.7.1.5.6)	Group E (acc. item A.7.1.5.6)	Group E (acc. item A.7.1.5.6)
18. Operator Type	Lever	Lever	Lever	Lever
19. Additional Requirement	Fire Tested (acc. item A.6.1.4)	Fire Tested (acc. item A.6.1.4)	Fire Tested (acc. item A.6.1.4)	Fire Tested (acc. item A.6.1.4)
20. Seat Type	N/A	N/A	N/A	N/A
21. Bore Type	Full Bore	Full Bore	Full Bore	Full Bore
22. Body Construction	One piece forged body	One piece forged body	One piece forged body	One piece forged body
23. Product Testing	FAT according A.9.3	FAT according A.9.3	FAT according A.9.3	FAT according A.9.3
24. Cladding or Coating	N/A	N/A	N/A	N/A
25. Notes	Needle valve between balls for cavity-pressure relief Max weight 55kg Minimum bore size 10mm	Needle valve between balls for cavity-pressure relief Max weight 55kg Minimum bore size 10mm	Needle valve between balls for cavity-pressure relief Max weight 55kg Minimum bore size 10mm	Needle valve between balls for cavity-pressure relief Max weight 55kg Minimum bore size 10mm

Valve Code	VDE-600-2-C205	VDE-600-2-C206	VDE-600-2-C214	VDE-600-2-C215
Specs	E6 E9 E10 E19	E6 E9 E10 E19	E6 E19	E6 E19
1. Valve Type	Double Ball	Double Ball	Double Ball	Double Ball
2. Sealing Type	Metal to Metal	Metal to Metal	Soft	Soft
3. Valve Specification Level (VSL)	VSL-2	VSL-2	VSL-2	VSL-2
4. Obturator Type	Floating	Floating	N/A	N/A
5. Standard	ASME B16.34	ASME B16.34	API 6D / IOGP S-562	API 6D / IOGP S-562
6. Size Range (NPS)	½" - 2"	½" - 2"	3" - 8"	3" - 8"
7. End Connection	Flange ASME B16.5, RF	Flange ASME B16.5, RF x NPT 1/2" ASME B1.20.1	N/A	N/A
8. Pressure Class	600	600	600	600
9. Temperature	-46°C to 200°C	-46°C to 200°C	-30°C to 150°C	-30°C to 150°C
10. Material Class	Carbon Steel	Carbon Steel	Carbon Steel	Carbon Steel
11. Body Material	ASTM A350 Gr LF2 CL1	ASTM A350 Gr LF2 CL1	ASTM A350 Gr LF2 CL1 or ASTM A352 Gr LCB	ASTM A350 Gr LF2 CL1 or ASTM A352 Gr LCB
12. Obturator Material	AISI 316 + Hard Coating (acc. Item A.7.1.7.4)	AISI 316 + Hard Coating (acc. Item A.7.1.7.4)	AISI 316	AISI 316
13. Seat Material	AISI 316 + Hard Coating (acc. Item A.7.1.7.4)	AISI 316 + Hard Coating (acc. Item A.7.1.7.4)	AISI 316	AISI 316
14. Seat Insert Material	N/A	N/A	PEEK	PEEK
15. Spring Material	N/A	N/A	UNS N07750	UNS N07750
16. Stem Material	ASTM A276 (UNS S31600)	ASTM A276 (UNS S31600)	ASTM A276 (UNS S31600)	ASTM A276 (UNS S31600)
17. Stem Seal Material	Group E (acc. item A.7.1.5.6)	Group E (acc. item A.7.1.5.6)	Group B (acc. item A.7.1.5.6)	Group B (acc. item A.7.1.5.6)
18. Operator Type	Lever	Lever	N/A	N/A
19. Additional Requirement	Fire Tested (acc. item A.6.1.4)	Fire Tested (acc. item A.6.1.4)	N/A	Fire Tested (acc. item A.6.1.4)
20. Seat Type	N/A	N/A	Side A: SPE / Side B: SPE; DBB	Side A: SPE / Side B: SPE; DBB
21. Bore Type	Full Bore	Full Bore	Full Bore	Full Bore
22. Body Construction	One piece forged body	One piece forged body	Compact flangeless single body double ball valve. Face to face according ASME B16.10	Compact flangeless single body double ball valve. Face to face according ASME B16.10
23. Product Testing	FAT according A.9.3	FAT according A.9.3	FAT according A.9.3	FAT according A.9.3
24. Cladding or Coating	N/A	N/A	Partial clad - SS316 weld overlay on all body sealing areas	Partial clad - SS316 weld overlay on all body sealing areas
25. Notes	Needle valve between balls for cavity-pressure relief Max weight 55kg Minimum bore size 10mm	Needle valve between balls for cavity-pressure relief Max weight 55kg Minimum bore size 10mm	Needle valve between balls for cavity-pressure relief All materials described in this datasheet are required for both valve	Needle valve between balls for cavity-pressure relief All materials described in this datasheet are required for both valve

Valve Code	VDE-600-2-C234		VDE-600-2-C235		VDE-600-2-C515		VDE-600-2-D201	
Specs	E6 E19		E6 E19		E30		E16	
1. Valve Type	Double Ball		Double Ball		Double Ball		Double Ball	
2. Sealing Type	Soft		Soft		Soft		Soft	
3. Valve Specification Level (VSL)	VSL-2		VSL-2		VSL-2		VSL-2	
4. Ball Mouting	Trunnion		Trunnion		Trunnion		N/A	
5. Standard	API 6D / IOGP S-562		API 6D / IOGP S-562		API 6D / IOGP S-562		ASME B16.34	
6. Size Range (NPS)	3" - 8"		3" - 8"		3" - 8"		½" - 2"	
7. End Connection	ASME B16.5, RF		ASME B16.5, RF		ASME B16.5, RF		N/A	
8. Pressure Class	600		600		600		600	
9. Temperature	-46°C to 150°C		-46°C to 150°C		-29°C to 150°C		-30°C to 150°C	
10. Material Class	Carbon Steel		Carbon Steel		Carbon Steel		Duplex Steel	
11. Body Material	ASTM A350 Gr LF2 CL1 or ASTM A352 Gr LCB + Inconel 625 weld overlay (acc. item A.7.1.7.3)		ASTM A350 Gr LF2 CL1 or ASTM A352 Gr LCB + Inconel 625 weld overlay (acc. item A.7.1.7.3)		ASTM A105 or ASTM A216 Gr WCB + Inconel 625 weld overlay (acc. item A.7.1.7.3)		ASTM A182 Gr F51	
12. Obturator Material	AISI 316		AISI 316		AISI 316 + Inconel 625 weld overlay (acc. item A.7.1.7.3)		Duplex (UNS S31803)	
13. Seat Material	AISI 316		AISI 316		AISI 316 + Inconel 625 weld overlay (acc. item A.7.1.7.3)		PEEK	
14. Seat Insert	PEEK		PEEK		PEEK		N/A	
15. Spring (Seat) Material	UNS N07750		UNS N07750		UNS N07750		N/A	
16. Stem Material	ASTM A276 (UNS S31600)		ASTM A276 (UNS S31600)		ASTM B637 (UNS N07718)		ASTM A276 (UNS S31803)	
17. Seat-Stem Seal	Group E (acc. item A.7.1.5.6)		Group E (acc. item A.7.1.5.6)		Group B (acc. item A.7.1.5.6)		Group B (acc. item A.7.1.5.6)	
18. Operator Type	3"	Lever	3"	Lever	3"	Lever	N/A	
	4" - 8"	Gearbox	4" - 8"	Gearbox	4" - 8"	Gearbox	N/A	
19. Additional Requirement	N/A		Fire Tested (acc. item A.6.1.4)		Fire Tested (acc. item A.6.1.4)		Fire Tested (acc. item A.6.1.4)	
20. Seat Type	Side A: SPE / Side B: SPE; DBB		Side A: SPE / Side B: SPE; DBB		Side A: SPE / Side B: SPE; DBB		N/A	
21. Bore Type	Full Bore		Full Bore		Full Bore		Full Bore	
22. Body Construction	Compact flangeless single body double ball valve. Face to face according ASME B16.10		Compact flangeless single body double ball valve. Face to face according ASME B16.10		Compact flangeless single body double ball valve. Face to face according ASME B16.10		One piece forged body	
23. Cladding or Coating	Partial clad - Inconel 625 weld overlay on all body sealing areas		Partial clad - Inconel 625 weld overlay on all body sealing areas		Full clad - Inconel 625 weld overlay on all wetted parts		N/A	
24. Valve Testing	FAT according A.9.3		FAT according A.9.3		FAT according A.9.3		FAT according A.9.3	
25. Notes	All materials described in this datasheet are required for both valve, Needle valve between balls for cavity-pressure relief		All materials described in this datasheet are required for both valve, Needle valve between balls for cavity-pressure relief		All materials described in this datasheet are required for both valve, Needle valve between balls for cavity-pressure relief		Max weight 55kg, Minimum bore size 10mm, Needle valve between balls for cavity-pressure relief	

Valve Code	VDE-600-2-D202	VDE-600-2-D203	VDE-600-2-D204	VDE-600-2-D214
Specs	E16	E16	E16	E16
1. Valve Type	Double Ball	Double Ball	Double Ball	Double Ball
2. Sealing Type	Soft	Soft	Soft	Soft
3. Valve Specification Level (VSL)	VSL-2	VSL-2	VSL-2	VSL-2
4. Obturator Type	Floating	Floating	Floating	N/A
5. Standard	ASME B16.34	ASME B16.34	ASME B16.34	API 6D / IOGP S-562
6. Size Range (NPS)	½" - 2"	½" - 2"	½" - 2"	3" - 8"
7. End Connection	Flange ASME B16.5, RF x NPT 1/2" ASME B1.20.1	Flange ASME B16.5, RTJ	Flange ASME B16.5, RF x NPT 1/2" ASME B1.20.1	N/A
8. Pressure Class	600	600	600	600
9. Temperature	-30°C to 150°C	-46°C to 150°C	-46°C to 150°C	-30°C to 150°C
10. Material Class	Duplex Steel	Duplex Steel	Duplex Steel	Duplex Steel
11. Body Material	ASTM A182 Gr F51	ASTM A182 Gr F51	ASTM A182 Gr F51	ASTM A182 Gr F51 or ASTM A995 Gr 4a
12. Obturator Material	Duplex (UNS S31803)	Duplex (UNS S31803)	Duplex (UNS S31803)	Duplex (UNS S31803)
13. Seat Material	PEEK	PEEK	PEEK	Duplex (UNS S31803)
14. Seat Insert Material	N/A	N/A	N/A	PEEK
15. Spring Material	N/A	N/A	N/A	UNS N07750
16. Stem Material	ASTM A276 (UNS S31803)	ASTM A276 (UNS S31803)	ASTM A276 (UNS S31803)	ASTM A276 (UNS S31803)
17. Stem Seal Material	Group B (acc. item A.7.1.5.6)	Group E (acc. item A.7.1.5.6)	Group E (acc. item A.7.1.5.6)	Group B (acc. item A.7.1.5.6)
18. Operator Type	Lever	Lever	Lever	N/A
19. Additional Requirement	Fire Tested (acc. item A.6.1.4)	Fire Tested (acc. item A.6.1.4)	Fire Tested (acc. item A.6.1.4)	N/A
20. Seat Type	N/A	N/A	N/A	Side A: SPE / Side B: SPE; DBB
21. Bore Type	Full Bore	Full Bore	Full Bore	Full Bore
22. Body Construction	One piece forged body	One piece forged body	One piece forged body	Compact flangeless single body double ball valve. Face to face according ASME B16.10
23. Product Testing	FAT according A.9.3	FAT according A.9.3	FAT according A.9.3	FAT according A.9.3
24. Cladding or Coating	N/A	N/A	N/A	N/A
25. Notes	Needle valve between balls for cavity-pressure relief Max weight 55kg Minimum bore size 10mm	Needle valve between balls for cavity-pressure relief Max weight 55kg Minimum bore size 10mm	Needle valve between balls for cavity-pressure relief Max weight 55kg Minimum bore size 10mm	Needle valve between balls for cavity-pressure relief All materials described in this datasheet are required for both valve

Valve Code	VDE-600-2-D215		VDE-600-2-D224		VDE-600-2-D225		VDE-600-2-D234	
Specs	E16		E16		E16		E16	
1. Valve Type	Double Ball		Double Ball		Double Ball		Double Ball	
2. Sealing Type	Soft		Soft		Soft		Soft	
3. Valve Specification Level (VSL)	VSL-2		VSL-2		VSL-2		VSL-2	
4. Ball Mouting	Trunnion		Trunnion		Trunnion		Trunnion	
5. Standard	API 6D / IOGP S-562		API 6D / IOGP S-562		API 6D / IOGP S-562		API 6D / IOGP S-562	
6. Size Range (NPS)	3" - 8"		3" - 8"		3" - 8"		3" - 8"	
7. End Connection	ASME B16.5, RF		ASME B16.5, RF		ASME B16.5, RF		ASME B16.5, RF	
8. Pressure Class	600		600		600		600	
9. Temperature	-30°C to 150°C		0°C to 150°C		0°C to 150°C		-46°C to 150°C	
10. Material Class	Duplex Steel		Duplex Steel		Duplex Steel		Duplex Steel	
11. Body Material	ASTM A182 Gr F51 or ASTM A995 Gr 4a		ASTM A182 Gr F51 or ASTM A995 Gr 4a		ASTM A182 Gr F51 or ASTM A995 Gr 4a		ASTM A182 Gr F51 or ASTM A995 Gr 4a	
12. Obturator Material	Duplex (UNS S31803)		Duplex (UNS S31803)		Duplex (UNS S31803)		Duplex (UNS S31803)	
13. Seat Material	Duplex (UNS S31803)		Duplex (UNS S31803)		Duplex (UNS S31803)		Duplex (UNS S31803)	
14. Seat Insert	PEEK		PEEK		PEEK		PEEK	
15. Spring (Seat) Material	UNS N07750		UNS N07750		UNS N07750		UNS N07750	
16. Stem Material	ASTM A276 (UNS S31803)		ASTM A276 (UNS S31803)		ASTM A276 (UNS S31803)		ASTM A276 (UNS S31803)	
17. Seat-Stem Seal	Group B (acc. item A.7.1.5.6)		Group C (acc. item A.7.1.5.6)		Group C (acc. item A.7.1.5.6)		Group E (acc. item A.7.1.5.6)	
18. Operator Type	3" 4" - 8"	Lever Gearbox	3" 4" - 8"	Lever Gearbox	3" 4" - 8"	Lever Gearbox	3" 4" - 8"	Lever Gearbox
19. Additional Requirement	Fire Tested (acc. item A.6.1.4)		N/A		Fire Tested (acc. item A.6.1.4)		N/A	
20. Seat Type	Side A: SPE / Side B: SPE; DBB		Side A: SPE / Side B: SPE; DBB		Side A: SPE / Side B: SPE; DBB		Side A: SPE / Side B: SPE; DBB	
21. Bore Type	Full Bore		Full Bore		Full Bore		Full Bore	
22. Body Construction	Compact flangeless single body double ball valve. Face to face according ASME B16.10		Compact flangeless single body double ball valve. Face to face according ASME B16.10		Compact flangeless single body double ball valve. Face to face according ASME B16.10		Compact flangeless single body double ball valve. Face to face according ASME B16.10	
23. Cladding or Coating	N/A		N/A		N/A		N/A	
24. Valve Testing	FAT according A.9.3		FAT according A.9.3		FAT according A.9.3		FAT according A.9.3	
25. Notes	All materials described in this datasheet are required for both valve, Needle valve between balls for cavity-pressure relief		All materials described in this datasheet are required for both valve, Needle valve between balls for cavity-pressure relief		All materials described in this datasheet are required for both valve, Needle valve between balls for cavity-pressure relief		All materials described in this datasheet are required for both valve, Needle valve between balls for cavity-pressure relief	

Valve Code	VDE-600-2-D235		VDE-600-2-N101	VDE-600-2-N105	VDE-600-2-N106
Specs	E16		E30	E32	E32
1. Valve Type	Double Ball		Double Ball	Double Ball	Double Ball
2. Sealing Type	Soft		Metal to Metal, Soft	Metal to Metal	Metal to Metal
3. Valve Specification Level (VSL)	VSL-2		VSL-2	VSL-2	VSL-2
4. Ball Mouting	Trunnion		N/A	N/A	N/A
5. Standard	API 6D / IOGP S-562		ASME B16.34	ASME B16.34	ASME B16.34
6. Size Range (NPS)	3" - 8"		½" - 2"	½" - 2"	½" - 2"
7. End Connection	ASME B16.5, RF		N/A	N/A	N/A
8. Pressure Class	600		600	600	600
9. Temperature	-46°C to 150°C		-30°C to 150°C	-100°C to 200°C	-100°C to 200°C
10. Material Class	Duplex Steel		Nickel Alloys	Nickel Alloys	Nickel Alloys
11. Body Material	ASTM A182 Gr F51 or ASTM A995 Gr 4a		ASTM B564 (UNS N06625)	ASTM B564 (UNS N06625)	ASTM B564 (UNS N06625)
12. Obturator Material	Duplex (UNS S31803)		ASTM B564 (UNS N06625) + Hard Coating (acc. Item A.7.1.7.4)	ASTM B564 (UNS N06625) + Hard Coating (acc. Item A.7.1.7.4)	ASTM B564 (UNS N06625) + Hard Coating (acc. Item A.7.1.7.4)
13. Seat Material	Duplex (UNS S31803)		ASTM B564 (UNS N06625) + Hard Coating (acc. Item A.7.1.7.4)	ASTM B564 (UNS N06625) + Hard Coating (acc. Item A.7.1.7.4)	ASTM B564 (UNS N06625) + Hard Coating (acc. Item A.7.1.7.4)
14. Seat Insert	PEEK		N/A	N/A	N/A
15. Spring (Seat) Material	UNS N07750		N/A	N/A	N/A
16. Stem Material	ASTM A276 (UNS S31803)		ASTM B637 (UNS N07718)	ASTM B637 (UNS N07718)	ASTM B637 (UNS N07718)
17. Seat-Stem Seal	Group E (acc. item A.7.1.5.6)		Group B (acc. item A.7.1.5.6)	Group E (acc. item A.7.1.5.6)	Group E (acc. item A.7.1.5.6)
18. Operator Type	3"	Lever	N/A	N/A	N/A
	4" - 8"	Gearbox	N/A	N/A	N/A
19. Additional Requirement	Fire Tested (acc. item A.6.1.4)		Fire Tested (acc. item A.6.1.4)	Fire Tested (acc. item A.6.1.4)	Fire Tested (acc. item A.6.1.4)
20. Seat Type	Side A: SPE / Side B: SPE; DBB		N/A	N/A	N/A
21. Bore Type	Full Bore		Full Bore	Full Bore	Full Bore
22. Body Construction	Compact flangeless single body double ball valve. Face to face according ASME B16.10		One piece forged body	One piece forged body	One piece forged body
23. Cladding or Coating	N/A		N/A	N/A	N/A
24. Valve Testing	FAT according A.9.3		FAT according A.9.3	FAT according A.9.3	FAT according A.9.3
25. Notes	All materials described in this datasheet are required for both valve, Needle valve between balls for cavity-pressure relief		Max weight 55kg, Minimum bore size 10mm, Needle valve between balls for cavity-pressure relief	Max weight 55kg, Minimum bore size 10mm, Needle valve between balls for cavity-pressure relief	Max weight 55kg, Minimum bore size 10mm, Needle valve between balls for cavity-pressure relief

Valve Code	VDE-600-2-N107	VDE-600-2-N108	VDE-600-2-S201	VDE-600-2-S202
Specs	E30 E32	E30 E32	E3	E3
1. Valve Type	Double Ball	Double Ball	Double Ball	Double Ball
2. Sealing Type	Metal to Metal	Metal to Metal	Soft	Soft
3. Valve Specification Level (VSL)	VSL-2	VSL-2	VSL-2	VSL-2
4. Obturator Type	Floating	Floating	Floating	Floating
5. Standard	ASME B16.34	ASME B16.34	ASME B16.34	ASME B16.34
6. Size Range (NPS)	½" - 2"	½" - 2"	½" - 2"	½" - 2"
7. End Connection	Flange ASME B16.5, RF	Flange ASME B16.5, RF x NPT 1/2" ASME B1.20.1	Flange ASME B16.5, RF	Flange ASME B16.5, RF x NPT 1/2" ASME B1.20.1
8. Pressure Class	600	600	600	600
9. Temperature	-100°C to 400°C	-100°C to 400°C	-30°C to 150°C	-30°C to 150°C
10. Material Class	Nickel Alloys	Nickel Alloys	Stainless Steel	Stainless Steel
11. Body Material	ASTM B564 (UNS N06625)	ASTM B564 (UNS N06625)	ASTM A182 Gr F316	ASTM A182 Gr F316
12. Obturator Material	ASTM B564 (UNS N06625) + Hard Coating (acc. Item A.7.1.7.4)	ASTM B564 (UNS N06625) + Hard Coating (acc. Item A.7.1.7.4)	AISI 316	AISI 316
13. Seat Material	ASTM B564 (UNS N06625) + Hard Coating (acc. Item A.7.1.7.4)	ASTM B564 (UNS N06625) + Hard Coating (acc. Item A.7.1.7.4)	PEEK	PEEK
14. Seat Insert Material	N/A	N/A	N/A	N/A
15. Spring Material	N/A	N/A	N/A	N/A
16. Stem Material	ASTM B637 (UNS N07718)	ASTM B637 (UNS N07718)	ASTM A276 (UNS S31600)	ASTM A276 (UNS S31600)
17. Stem Seal Material	Group F (acc. item A.7.1.5.6)	Group F (acc. item A.7.1.5.6)	Group B (acc. item A.7.1.5.6)	Group B (acc. item A.7.1.5.6)
18. Operator Type	Lever	Lever	Lever	Lever
19. Additional Requirement	Fire Tested (acc. item A.6.1.4)	Fire Tested (acc. item A.6.1.4)	Fire Tested (acc. item A.6.1.4)	Fire Tested (acc. item A.6.1.4)
20. Seat Type	N/A	N/A	N/A	N/A
21. Bore Type	Full Bore	Full Bore	Full Bore	Full Bore
22. Body Construction	One piece forged body	One piece forged body	One piece forged body	One piece forged body
23. Product Testing	FAT according A.9.3	FAT according A.9.3	FAT according A.9.3	FAT according A.9.3
24. Cladding or Coating	N/A	N/A	N/A	N/A
25. Notes	Needle valve between balls for cavity-pressure relief Max weight 55kg Minimum bore size 10mm	Needle valve between balls for cavity-pressure relief Max weight 55kg Minimum bore size 10mm	Needle valve between balls for cavity-pressure relief Max weight 55kg Minimum bore size 10mm	Needle valve between balls for cavity-pressure relief Max weight 55kg Minimum bore size 10mm

Valve Code	VDE-600-2-S203	VDE-600-2-S204	VDE-600-2-S205	VDE-600-2-S206
Specs	E3	E3	E3	E3
1. Valve Type	Double Ball	Double Ball	Double Ball	Double Ball
2. Sealing Type	Soft	Soft	Metal to Metal	Metal to Metal
3. Valve Specification Level (VSL)	VSL-2	VSL-2	VSL-2	VSL-2
4. Obturator Type	Floating	Floating	Floating	Floating
5. Standard	ASME B16.34	ASME B16.34	ASME B16.34	ASME B16.34
6. Size Range (NPS)	½" - 2"	½" - 2"	½" - 2"	½" - 2"
7. End Connection	Flange ASME B16.5, RF	Flange ASME B16.5, RF x NPT 1/2" ASME B1.20.1	Flange ASME B16.5, RF	Flange ASME B16.5, RF x NPT 1/2" ASME B1.20.1
8. Pressure Class	600	600	600	600
9. Temperature	-46°C to 150°C	-46°C to 150°C	-100°C to 200°C	-100°C to 200°C
10. Material Class	Stainless Steel	Stainless Steel	Stainless Steel	Stainless Steel
11. Body Material	ASTM A182 Gr F316	ASTM A182 Gr F316	ASTM A182 Gr F316	ASTM A182 Gr F316
12. Obturator Material	AISI 316	AISI 316	AISI 316 + Hard Coating (acc. Item A.7.1.7.4)	AISI 316 + Hard Coating (acc. Item A.7.1.7.4)
13. Seat Material	PEEK	PEEK	AISI 316 + Hard Coating (acc. Item A.7.1.7.4)	AISI 316 + Hard Coating (acc. Item A.7.1.7.4)
14. Seat Insert Material	N/A	N/A	N/A	N/A
15. Spring Material	N/A	N/A	N/A	N/A
16. Stem Material	ASTM A276 (UNS S31600)	ASTM A276 (UNS S31600)	ASTM A276 (UNS S31600)	ASTM A276 (UNS S31600)
17. Stem Seal Material	Group E (acc. item A.7.1.5.6)	Group E (acc. item A.7.1.5.6)	Group E (acc. item A.7.1.5.6)	Group E (acc. item A.7.1.5.6)
18. Operator Type	Lever	Lever	Lever	Lever
19. Additional Requirement	Fire Tested (acc. item A.6.1.4)	Fire Tested (acc. item A.6.1.4)	Fire Tested (acc. item A.6.1.4)	Fire Tested (acc. item A.6.1.4)
20. Seat Type	N/A	N/A	N/A	N/A
21. Bore Type	Full Bore	Full Bore	Full Bore	Full Bore
22. Body Construction	One piece forged body	One piece forged body	One piece forged body	One piece forged body
23. Product Testing	FAT according A.9.3	FAT according A.9.3	FAT according A.9.3	FAT according A.9.3
24. Cladding or Coating	N/A	N/A	N/A	N/A
25. Notes	Needle valve between balls for cavity-pressure relief Max weight 55kg Minimum bore size 10mm	Needle valve between balls for cavity-pressure relief Max weight 55kg Minimum bore size 10mm	Needle valve between balls for cavity-pressure relief Max weight 55kg Minimum bore size 10mm	Needle valve between balls for cavity-pressure relief Max weight 55kg Minimum bore size 10mm

Valve Code	VDE-600-2-S214		VDE-600-2-S215		VDE-600-2-S224		VDE-600-2-S225	
Specs	E3		E3		E3		E3	
1. Valve Type	Double Ball		Double Ball		Double Ball		Double Ball	
2. Sealing Type	Soft		Soft		Soft		Soft	
3. Valve Specification Level (VSL)	VSL-2		VSL-2		VSL-2		VSL-2	
4. Ball Mouting	Trunnion		Trunnion		Trunnion		Trunnion	
5. Standard	API 6D / IOGP S-562		API 6D / IOGP S-562		API 6D / IOGP S-562		API 6D / IOGP S-562	
6. Size Range (NPS)	3" - 8"		3" - 8"		3" - 8"		3" - 8"	
7. End Connection	ASME B16.5, RF		ASME B16.5, RF		ASME B16.5, RF		ASME B16.5, RF	
8. Pressure Class	600		600		600		600	
9. Temperature	-30°C to 150°C		-30°C to 150°C		0°C to 150°C		0°C to 150°C	
10. Material Class	Stainless Steel		Stainless Steel		Stainless Steel		Stainless Steel	
11. Body Material	ASTM A182 Gr F316 or ASTM A351 Gr CF8M		ASTM A182 Gr F316 or ASTM A351 Gr CF8M		ASTM A182 Gr F316 or ASTM A351 Gr CF8M		ASTM A182 Gr F316 or ASTM A351 Gr CF8M	
12. Obturator Material	AISI 316		AISI 316		AISI 316		AISI 316	
13. Seat Material	AISI 316		AISI 316		AISI 316		AISI 316	
14. Seat Insert	PEEK		PEEK		PEEK		PEEK	
15. Spring (Seat) Material	UNS N07750		UNS N07750		UNS N07750		UNS N07750	
16. Stem Material	ASTM A276 (UNS S31600)		ASTM A276 (UNS S31600)		ASTM A276 (UNS S31600)		ASTM A276 (UNS S31600)	
17. Seat-Stem Seal	Group B (acc. item A.7.1.5.6)		Group B (acc. item A.7.1.5.6)		Group C (acc. item A.7.1.5.6)		Group C (acc. item A.7.1.5.6)	
18. Operator Type	3"	Lever	3"	Lever	3"	Lever	3"	Lever
	4" - 8"	Gearbox	4" - 8"	Gearbox	4" - 8"	Gearbox	4" - 8"	Gearbox
19. Additional Requirement	N/A		Fire Tested (acc. item A.6.1.4)		N/A		Fire Tested (acc. item A.6.1.4)	
20. Seat Type	Side A: SPE / Side B: SPE; DBB		Side A: SPE / Side B: SPE; DBB		Side A: SPE / Side B: SPE; DBB		Side A: SPE / Side B: SPE; DBB	
21. Bore Type	Full Bore		Full Bore		Full Bore		Full Bore	
22. Body Construction	Compact flangeless single body double ball valve. Face to face according ASME B16.10		Compact flangeless single body double ball valve. Face to face according ASME B16.10		Compact flangeless single body double ball valve. Face to face according ASME B16.10		Compact flangeless single body double ball valve. Face to face according ASME B16.10	
23. Cladding or Coating	N/A		N/A		N/A		N/A	
24. Valve Testing	FAT according A.9.3		FAT according A.9.3		FAT according A.9.3		FAT according A.9.3	
25. Notes	All materials described in this datasheet are required for both valve, Needle valve between balls for cavity-pressure relief		All materials described in this datasheet are required for both valve, Needle valve between balls for cavity-pressure relief		All materials described in this datasheet are required for both valve, Needle valve between balls for cavity-pressure relief		All materials described in this datasheet are required for both valve, Needle valve between balls for cavity-pressure relief	

Valve Code	VDE-600-2-S234		VDE-600-2-S235		VDE-600-2-S270		VDE-900-2-C114	
Specs	E3		E3		E3		F10	
1. Valve Type	Double Ball		Double Ball		Double Ball		Double Ball	
2. Sealing Type	Soft		Soft		Metal to Metal		Soft	
3. Valve Specification Level (VSL)	VSL-2		VSL-2		VSL-2		VSL-2	
4. Ball Mouting	Trunnion		Trunnion		Trunnion		Trunnion	
5. Standard	API 6D / IOGP S-562		API 6D / IOGP S-562		API 6D / IOGP S-562		API 6D / IOGP S-562	
6. Size Range (NPS)	3" - 8"		3" - 8"		3" - 8"		3" - 8"	
7. End Connection	ASME B16.5, RF		ASME B16.5, RF		ASME B16.5, RF		ASME B16.5, RTJ	
8. Pressure Class	600		600		600		900	
9. Temperature	-46°C to 150°C		-46°C to 150°C		-100°C to 200°C		0°C to 150°C	
10. Material Class	Stainless Steel		Stainless Steel		Stainless Steel		Carbon Steel	
11. Body Material	ASTM A182 Gr F316 or ASTM A351 Gr CF8M + Inconel 625 weld overlay (acc. item A.7.1.7.3)		ASTM A182 Gr F316 or ASTM A351 Gr CF8M + Inconel 625 weld overlay (acc. item A.7.1.7.3)		ASTM A182 Gr F316 or ASTM A351 Gr CF8M		ASTM A105 or ASTM A216 Gr WCB + SS316 weld overlay (acc. item A.7.1.7.3)	
12. Obturator Material	AISI 316		AISI 316		AISI 316 + Hard Coating (acc. Item A.7.1.7.4)		AISI 410	
13. Seat Material	AISI 316		AISI 316		AISI 316 + Hard Coating (acc. Item A.7.1.7.4)		AISI 410	
14. Seat Insert	PEEK		PEEK		N/A		PEEK	
15. Spring (Seat) Material	UNS N07750		UNS N07750		UNS N07750		UNS N07750	
16. Stem Material	ASTM A276 (UNS S31600)		ASTM A276 (UNS S31600)		ASTM A276 (UNS S31600)		ASTM A276 (UNS S41000)	
17. Seat-Stem Seal	Group E (acc. item A.7.1.5.6)		Group E (acc. item A.7.1.5.6)		Group E (acc. item A.7.1.5.6)		Group A (acc. item A.7.1.5.6)	
18. Operator Type	3"	Lever	3"	Lever	3"	Lever	3"	Lever
	4" - 8"	Gearbox	4" - 8"	Gearbox	4" - 8"	Gearbox	4" - 8"	Gearbox
19. Additional Requirement	N/A		Fire Tested (acc. item A.6.1.4)		N/A		N/A	
20. Seat Type	Side A: SPE / Side B: SPE; DBB		Side A: SPE / Side B: SPE; DBB		Side A: SPE / Side B: SPE		Side A: SPE / Side B: SPE; DBB	
21. Bore Type	Full Bore		Full Bore		Full Bore		Full Bore	
22. Body Construction	Compact flangeless single body double ball valve. Face to face according ASME B16.10		Compact flangeless single body double ball valve. Face to face according ASME B16.10		Compact flangeless single body double ball valve. Face to face according ASME B16.10		Compact flangeless single body double ball valve. Face to face according ASME B16.10	
23. Cladding or Coating	Partial clad - Inconel 625 weld overlay on all body sealing areas		Partial clad - Inconel 625 weld overlay on all body sealing areas		N/A		Partial clad - SS316 weld overlay on all body sealing areas	
24. Valve Testing	FAT according A.9.3		FAT according A.9.3		FAT according A.9.3		FAT according A.9.3	
25. Notes	All materials described in this datasheet are required for both valve, Needle valve between balls for cavity-pressure relief		All materials described in this datasheet are required for both valve, Needle valve between balls for cavity-pressure relief		All materials described in this datasheet are required for both valve, Needle valve between balls for cavity-pressure relief		All materials described in this datasheet are required for both valve, Needle valve between balls for cavity-pressure relief	

Valve Code	VDE-900-2-C115		VDE-900-2-C134		VDE-900-2-C135		VDE-900-2-C201	
Specs	F10		F10		F10		F6 F10	
1. Valve Type	Double Ball		Double Ball		Double Ball		Double Ball	
2. Sealing Type	Soft		Soft		Soft		Soft	
3. Valve Specification Level (VSL)	VSL-2		VSL-2		VSL-2		VSL-2	
4. Ball Mouting	Trunnion		Trunnion		Trunnion		N/A	
5. Standard	API 6D / IOGP S-562		API 6D / IOGP S-562		API 6D / IOGP S-562		ASME B16.34	
6. Size Range (NPS)	3" - 8"		3" - 8"		3" - 8"		½" - 2"	
7. End Connection	ASME B16.5, RTJ		ASME B16.5, RTJ		ASME B16.5, RTJ		N/A	
8. Pressure Class	900		900		900		900	
9. Temperature	-30°C to 150°C		0°C to 150°C		-46°C to 150°C		-30°C to 150°C	
10. Material Class	Carbon Steel		Carbon Steel		Carbon Steel		Carbon Steel	
11. Body Material	ASTM A105 or ASTM A216 Gr WCB + SS316 weld overlay (acc. item A.7.1.7.3)		ASTM A105 or ASTM A216 Gr WCB + SS316 weld overlay (acc. item A.7.1.7.3)		ASTM A105 or ASTM A216 Gr WCB + Inconel 625 weld overlay (acc. item A.7.1.7.3)		ASTM A350 Gr LF2 CL1	
12. Obturator Material	AISI 410		AISI 410		AISI 410		AISI 316	
13. Seat Material	AISI 410		AISI 410		AISI 410		PEEK	
14. Seat Insert	PEEK		PEEK		PEEK		N/A	
15. Spring (Seat) Material	UNS N07750		UNS N07750		UNS N07750		N/A	
16. Stem Material	ASTM A276 (UNS S41000)		ASTM A276 (UNS S41000)		ASTM A276 (UNS S41000)		ASTM A276 (UNS S31600)	
17. Seat-Stem Seal	Group B (acc. item A.7.1.5.6)		Group D (acc. item A.7.1.5.6)		Group E (acc. item A.7.1.5.6)		Group B (acc. item A.7.1.5.6)	
18. Operator Type	3"	Lever	3"	Lever	3"	Lever	N/A	
	4" - 8"	Gearbox	4" - 8"	Gearbox	4" - 8"	Gearbox	N/A	
19. Additional Requirement	Fire Tested (acc. item A.6.1.4)		N/A		Fire Tested (acc. item A.6.1.4)		Fire Tested (acc. item A.6.1.4)	
20. Seat Type	Side A: SPE / Side B: SPE; DBB		Side A: SPE / Side B: SPE; DBB		Side A: SPE / Side B: SPE; DBB		N/A	
21. Bore Type	Full Bore		Full Bore		Full Bore		Full Bore	
22. Body Construction	Compact flangeless single body double ball valve. Face to face according ASME B16.10		Compact flangeless single body double ball valve. Face to face according ASME B16.10		Compact flangeless single body double ball valve. Face to face according ASME B16.10		One piece forged body	
23. Cladding or Coating	Partial clad - SS316 weld overlay on all body sealing areas		Partial clad - SS316 weld overlay on all body sealing areas		Partial clad - Inconel 625 weld overlay on all body sealing areas		N/A	
24. Valve Testing	FAT according A.9.3		FAT according A.9.3		FAT according A.9.3		FAT according A.9.3	
25. Notes	All materials described in this datasheet are required for both valve, Needle valve between balls for cavity-pressure relief		All materials described in this datasheet are required for both valve, Needle valve between balls for cavity-pressure relief		All materials described in this datasheet are required for both valve, Needle valve between balls for cavity-pressure relief		Max weight 55kg, Minimum bore size 10mm, Needle valve between balls for cavity-pressure relief	

Valve Code	VDE-900-2-C202	VDE-900-2-C203	VDE-900-2-C204	VDE-900-2-C205
Specs	F6 F10	F6 F10	F6 F10	F6 F10
1. Valve Type	Double Ball	Double Ball	Double Ball	Double Ball
2. Sealing Type	Soft	Soft	Soft	Metal to Metal
3. Valve Specification Level (VSL)	VSL-2	VSL-2	VSL-2	VSL-2
4. Obturator Type	Floating	Floating	Floating	Floating
5. Standard	ASME B16.34	ASME B16.34	ASME B16.34	ASME B16.34
6. Size Range (NPS)	½" - 2"	½" - 2"	½" - 2"	½" - 2"
7. End Connection	Flange ASME B16.5, RTJ x NPT 1/2" ASME B1.20.1	Flange ASME B16.5, RTJ	Flange ASME B16.5, RTJ x NPT 1/2" ASME B1.20.1	Flange ASME B16.5, RTJ
8. Pressure Class	900	900	900	900
9. Temperature	-30°C to 150°C	-46°C to 150°C	-46°C to 150°C	-46°C to 200°C
10. Material Class	Carbon Steel	Carbon Steel	Carbon Steel	Carbon Steel
11. Body Material	ASTM A350 Gr LF2 CL1	ASTM A350 Gr LF2 CL1	ASTM A350 Gr LF2 CL1	ASTM A350 Gr LF2 CL1
12. Obturator Material	AISI 316	AISI 316	AISI 316	AISI 316 + Hard Coating (acc. Item A.7.1.7.4)
13. Seat Material	PEEK	PEEK	PEEK	AISI 316 + Hard Coating (acc. Item A.7.1.7.4)
14. Seat Insert Material	N/A	N/A	N/A	N/A
15. Spring Material	N/A	N/A	N/A	N/A
16. Stem Material	ASTM A276 (UNS S31600)	ASTM A276 (UNS S31600)	ASTM A276 (UNS S31600)	ASTM A276 (UNS S31600)
17. Stem Seal Material	Group B (acc. item A.7.1.5.6)	Group E (acc. item A.7.1.5.6)	Group E (acc. item A.7.1.5.6)	Group E (acc. item A.7.1.5.6)
18. Operator Type	Lever	Lever	Lever	Lever
19. Additional Requirement	Fire Tested (acc. item A.6.1.4)	Fire Tested (acc. item A.6.1.4)	Fire Tested (acc. item A.6.1.4)	Fire Tested (acc. item A.6.1.4)
20. Seat Type	N/A	N/A	N/A	N/A
21. Bore Type	Full Bore	Full Bore	Full Bore	Full Bore
22. Body Construction	One piece forged body	One piece forged body	One piece forged body	One piece forged body
23. Product Testing	FAT according A.9.3	FAT according A.9.3	FAT according A.9.3	FAT according A.9.3
24. Cladding or Coating	N/A	N/A	N/A	N/A
25. Notes	Needle valve between balls for cavity-pressure relief Max weight 55kg Minimum bore size 10mm	Needle valve between balls for cavity-pressure relief Max weight 55kg Minimum bore size 10mm	Needle valve between balls for cavity-pressure relief Max weight 55kg Minimum bore size 10mm	Needle valve between balls for cavity-pressure relief Max weight 55kg Minimum bore size 10mm

Valve Code	VDE-900-2-C206	VDE-900-2-C207	VDE-900-2-C214	VDE-900-2-C215
Specs	F6 F10	F6	F6	F6
1. Valve Type	Double Ball	Double Ball	Double Ball	Double Ball
2. Sealing Type	Metal to Metal	Metal to Metal	Soft	Soft
3. Valve Specification Level (VSL)	VSL-2	VSL-2	VSL-2	VSL-2
4. Obturator Type	Floating	Floating	N/A	N/A
5. Standard	ASME B16.34	ASME B16.34	API 6D / IOGP S-562	API 6D / IOGP S-562
6. Size Range (NPS)	½" - 2"	½" - 2"	3" - 8"	3" - 8"
7. End Connection	Flange ASME B16.5, RTJ x NPT 1/2" ASME B1.20.1	Flange ASME B16.5, RTJ	N/A	N/A
8. Pressure Class	900	900	900	900
9. Temperature	-46°C to 200°C	-46°C to 340°C	-30°C to 150°C	-30°C to 150°C
10. Material Class	Carbon Steel	Carbon Steel	Carbon Steel	Carbon Steel
11. Body Material	ASTM A350 Gr LF2 CL1	ASTM A350 Gr LF2 CL1	ASTM A350 Gr LF2 CL1 or ASTM A352 Gr LCB	ASTM A350 Gr LF2 CL1 or ASTM A352 Gr LCB
12. Obturator Material	AISI 316 + Hard Coating (acc. Item A.7.1.7.4)	AISI 316 + Hard Coating (acc. Item A.7.1.7.4)	AISI 316	AISI 316
13. Seat Material	AISI 316 + Hard Coating (acc. Item A.7.1.7.4)	AISI 316 + Hard Coating (acc. Item A.7.1.7.4)	AISI 316	AISI 316
14. Seat Insert Material	N/A	N/A	PEEK	PEEK
15. Spring Material	N/A	N/A	UNS N07750	UNS N07750
16. Stem Material	ASTM A276 (UNS S31600)	ASTM A276 (UNS S32760)	ASTM A276 (UNS S31600)	ASTM A276 (UNS S31600)
17. Stem Seal Material	Group E (acc. item A.7.1.5.6)	Group F (acc. item A.7.1.5.6)	Group B (acc. item A.7.1.5.6)	Group B (acc. item A.7.1.5.6)
18. Operator Type	Lever	Lever	N/A	N/A
19. Additional Requirement	Fire Tested (acc. item A.6.1.4)	Fire Tested (acc. item A.6.1.4)	N/A	Fire Tested (acc. item A.6.1.4)
20. Seat Type	N/A	N/A	Side A: SPE / Side B: SPE; DBB	Side A: SPE / Side B: SPE; DBB
21. Bore Type	Full Bore	Full Bore	Full Bore	Full Bore
22. Body Construction	One piece forged body	One piece forged body	Compact flangeless single body double ball valve. Face to face according ASME B16.10	Compact flangeless single body double ball valve. Face to face according ASME B16.10
23. Product Testing	FAT according A.9.3	FAT according A.9.3	FAT according A.9.3	FAT according A.9.3
24. Cladding or Coating	N/A	N/A	Partial clad - SS316 weld overlay on all body sealing areas	Partial clad - SS316 weld overlay on all body sealing areas
25. Notes	Needle valve between balls for cavity-pressure relief Max weight 55kg Minimum bore size 10mm	Needle valve between balls for cavity-pressure relief Max weight 55kg Minimum bore size 10mm	Needle valve between balls for cavity-pressure relief All materials described in this datasheet are required for both valve	Needle valve between balls for cavity-pressure relief All materials described in this datasheet are required for both valve

Valve Code	VDE-900-2-C234		VDE-900-2-C235		VDE-900-2-S201	VDE-900-2-S202
Specs	F6		F6		F3	F3
1. Valve Type	Double Ball		Double Ball		Double Ball	Double Ball
2. Sealing Type	Soft		Soft		Soft	Soft
3. Valve Specification Level (VSL)	VSL-2		VSL-2		VSL-2	VSL-2
4. Ball Mouting	Trunnion		Trunnion		N/A	N/A
5. Standard	API 6D / IOGP S-562		API 6D / IOGP S-562		ASME B16.34	ASME B16.34
6. Size Range (NPS)	3" - 8"		3" - 8"		½" - 2"	½" - 2"
7. End Connection	ASME B16.5, RTJ		ASME B16.5, RTJ		N/A	N/A
8. Pressure Class	900		900		900	900
9. Temperature	-46°C to 150°C		-46°C to 150°C		-30°C to 150°C	-30°C to 150°C
10. Material Class	Carbon Steel		Carbon Steel		Stainless Steel	Stainless Steel
11. Body Material	ASTM A350 Gr LF2 CL1 or ASTM A352 Gr LCB + Inconel 625 weld overlay (acc. item A.7.1.7.3)		ASTM A350 Gr LF2 CL1 or ASTM A352 Gr LCB + Inconel 625 weld overlay (acc. item A.7.1.7.3)		ASTM A182 Gr F316	ASTM A182 Gr F316
12. Obturator Material	AISI 316		AISI 316		AISI 316	AISI 316
13. Seat Material	AISI 316		AISI 316		PEEK	PEEK
14. Seat Insert	PEEK		PEEK		N/A	N/A
15. Spring (Seat) Material	UNS N07750		UNS N07750		N/A	N/A
16. Stem Material	ASTM A276 (UNS S31600)		ASTM A276 (UNS S31600)		ASTM A276 (UNS S31600)	ASTM A276 (UNS S31600)
17. Seat-Stem Seal	Group E (acc. item A.7.1.5.6)		Group E (acc. item A.7.1.5.6)		Group B (acc. item A.7.1.5.6)	Group B (acc. item A.7.1.5.6)
18. Operator Type	3"	Lever	3"	Lever	N/A	N/A
	4" - 8"	Gearbox	4" - 8"	Gearbox	N/A	N/A
19. Additional Requirement	N/A		Fire Tested (acc. item A.6.1.4)		Fire Tested (acc. item A.6.1.4)	Fire Tested (acc. item A.6.1.4)
20. Seat Type	Side A: SPE / Side B: SPE; DBB		Side A: SPE / Side B: SPE; DBB		N/A	N/A
21. Bore Type	Full Bore		Full Bore		Full Bore	Full Bore
22. Body Construction	Compact flangeless single body double ball valve. Face to face according ASME B16.10		Compact flangeless single body double ball valve. Face to face according ASME B16.10		One piece forged body	One piece forged body
23. Cladding or Coating	Partial clad - Inconel 625 weld overlay on all body sealing areas		Partial clad - Inconel 625 weld overlay on all body sealing areas		N/A	N/A
24. Valve Testing	FAT according A.9.3		FAT according A.9.3		FAT according A.9.3	FAT according A.9.3
25. Notes	All materials described in this datasheet are required for both valve, Needle valve between balls for cavity-pressure relief		All materials described in this datasheet are required for both valve, Needle valve between balls for cavity-pressure relief		Max weight 55kg, Minimum bore size 10mm, Needle valve between balls for cavity-pressure relief	Max weight 55kg, Minimum bore size 10mm, Needle valve between balls for cavity-pressure relief

Valve Code	VDE-900-2-S203	VDE-900-2-S204	VDE-900-2-S205	VDE-900-2-S206
Specs	F3	F3	F3	F3
1. Valve Type	Double Ball	Double Ball	Double Ball	Double Ball
2. Sealing Type	Soft	Soft	Metal to Metal	Metal to Metal
3. Valve Specification Level (VSL)	VSL-2	VSL-2	VSL-2	VSL-2
4. Obturator Type	Floating	Floating	Floating	Floating
5. Standard	ASME B16.34	ASME B16.34	ASME B16.34	ASME B16.34
6. Size Range (NPS)	½" - 2"	½" - 2"	½" - 2"	½" - 2"
7. End Connection	Flange ASME B16.5, RTJ	Flange ASME B16.5, RTJ x NPT 1/2" ASME B1.20.1	Flange ASME B16.5, RTJ	Flange ASME B16.5, RTJ x NPT 1/2" ASME B1.20.1
8. Pressure Class	900	900	900	900
9. Temperature	-46°C to 150°C	-46°C to 150°C	-100°C to 200°C	-100°C to 200°C
10. Material Class	Stainless Steel	Stainless Steel	Stainless Steel	Stainless Steel
11. Body Material	ASTM A182 Gr F316	ASTM A182 Gr F316	ASTM A182 Gr F316	ASTM A182 Gr F316
12. Obturator Material	AISI 316	AISI 316	AISI 316 + Hard Coating (acc. Item A.7.1.7.4)	AISI 316 + Hard Coating (acc. Item A.7.1.7.4)
13. Seat Material	PEEK	PEEK	AISI 316 + Hard Coating (acc. Item A.7.1.7.4)	AISI 316 + Hard Coating (acc. Item A.7.1.7.4)
14. Seat Insert Material	N/A	N/A	N/A	N/A
15. Spring Material	N/A	N/A	N/A	N/A
16. Stem Material	ASTM A276 (UNS S31600)	ASTM A276 (UNS S31600)	ASTM A276 (UNS S31600)	ASTM A276 (UNS S31600)
17. Stem Seal Material	Group E (acc. item A.7.1.5.6)	Group E (acc. item A.7.1.5.6)	Group E (acc. item A.7.1.5.6)	Group E (acc. item A.7.1.5.6)
18. Operator Type	Lever	Lever	Lever	Lever
19. Additional Requirement	Fire Tested (acc. item A.6.1.4)	Fire Tested (acc. item A.6.1.4)	Fire Tested (acc. item A.6.1.4)	Fire Tested (acc. item A.6.1.4)
20. Seat Type	N/A	N/A	N/A	N/A
21. Bore Type	Full Bore	Full Bore	Full Bore	Full Bore
22. Body Construction	One piece forged body	One piece forged body	One piece forged body	One piece forged body
23. Product Testing	FAT according A.9.3	FAT according A.9.3	FAT according A.9.3	FAT according A.9.3
24. Cladding or Coating	N/A	N/A	N/A	N/A
25. Notes	Needle valve between balls for cavity-pressure relief Max weight 55kg Minimum bore size 10mm	Needle valve between balls for cavity-pressure relief Max weight 55kg Minimum bore size 10mm	Needle valve between balls for cavity-pressure relief Max weight 55kg Minimum bore size 10mm	Needle valve between balls for cavity-pressure relief Max weight 55kg Minimum bore size 10mm

Valve Code	VDE-900-2-S214		VDE-900-2-S215		VDE-900-2-S234		VDE-900-2-S235	
Specs	F3		F3		F3		F3	
1. Valve Type	Double Ball		Double Ball		Double Ball		Double Ball	
2. Sealing Type	Soft		Soft		Soft		Soft	
3. Valve Specification Level (VSL)	VSL-2		VSL-2		VSL-2		VSL-2	
4. Ball Mouting	Trunnion		Trunnion		Trunnion		Trunnion	
5. Standard	API 6D / IOGP S-562		API 6D / IOGP S-562		API 6D / IOGP S-562		API 6D / IOGP S-562	
6. Size Range (NPS)	3" - 8"		3" - 8"		3" - 8"		3" - 8"	
7. End Connection	ASME B16.5, RTJ		ASME B16.5, RTJ		ASME B16.5, RTJ		ASME B16.5, RTJ	
8. Pressure Class	900		900		900		900	
9. Temperature	-30°C to 150°C		-30°C to 150°C		-46°C to 150°C		-46°C to 150°C	
10. Material Class	Stainless Steel		Stainless Steel		Stainless Steel		Stainless Steel	
11. Body Material	ASTM A182 Gr F316 or ASTM A351 Gr CF8M		ASTM A182 Gr F316 or ASTM A351 Gr CF8M		ASTM A182 Gr F316 or ASTM A351 Gr CF8M + Inconel 625 weld overlay (acc. item A.7.1.7.3)		ASTM A182 Gr F316 or ASTM A351 Gr CF8M + Inconel 625 weld overlay (acc. item A.7.1.7.3)	
12. Obturator Material	AISI 316		AISI 316		AISI 316		AISI 316	
13. Seat Material	AISI 316		AISI 316		AISI 316		AISI 316	
14. Seat Insert	PEEK		PEEK		PEEK		PEEK	
15. Spring (Seat) Material	UNS N07750		UNS N07750		UNS N07750		UNS N07750	
16. Stem Material	ASTM A276 (UNS S31600)		ASTM A276 (UNS S31600)		ASTM A276 (UNS S31600)		ASTM A276 (UNS S31600)	
17. Seat-Stem Seal	Group B (acc. item A.7.1.5.6)		Group B (acc. item A.7.1.5.6)		Group E (acc. item A.7.1.5.6)		Group E (acc. item A.7.1.5.6)	
18. Operator Type	3"	Lever	3"	Lever	3"	Lever	3"	Lever
	4" - 8"	Gearbox	4" - 8"	Gearbox	4" - 8"	Gearbox	4" - 8"	Gearbox
19. Additional Requirement	N/A		Fire Tested (acc. item A.6.1.4)		N/A		Fire Tested (acc. item A.6.1.4)	
20. Seat Type	Side A: SPE / Side B: SPE; DBB		Side A: SPE / Side B: SPE; DBB		Side A: SPE / Side B: SPE; DBB		Side A: SPE / Side B: SPE; DBB	
21. Bore Type	Full Bore		Full Bore		Full Bore		Full Bore	
22. Body Construction	Compact flangeless single body double ball valve. Face to face according ASME B16.10		Compact flangeless single body double ball valve. Face to face according ASME B16.10		Compact flangeless single body double ball valve. Face to face according ASME B16.10		Compact flangeless single body double ball valve. Face to face according ASME B16.10	
23. Cladding or Coating	N/A		N/A		Partial clad - Inconel 625 weld overlay on all body sealing areas		Partial clad - Inconel 625 weld overlay on all body sealing areas	
24. Valve Testing	FAT according A.9.3		FAT according A.9.3		FAT according A.9.3		FAT according A.9.3	
25. Notes	All materials described in this datasheet are required for both valve, Needle valve between balls for cavity-pressure relief		All materials described in this datasheet are required for both valve, Needle valve between balls for cavity-pressure relief		All materials described in this datasheet are required for both valve, Needle valve between balls for cavity-pressure relief		All materials described in this datasheet are required for both valve, Needle valve between balls for cavity-pressure relief	

Valve Code	VDE-900-2-S270	
Specs	F3	
1. Valve Type	Double Ball	
2. Sealing Type	Metal to Metal	
3. Valve Specification Level (VSL)	VSL-2	
4. Ball Mouting	Trunnion	
5. Standard	API 6D / IOGP S-562	
6. Size Range (NPS)	3" - 8"	
7. End Connection	ASME B16.5, RF	
8. Pressure Class	900	
9. Temperature	-100°C to 200°C	
10. Material Class	Stainless Steel	
11. Body Material	ASTM A182 Gr F316 or ASTM A351 Gr CF8M	
12. Obturator Material	AISI 316 + Hard Coating (acc. Item A.7.1.7.4)	
13. Seat Material	AISI 316 + Hard Coating (acc. Item A.7.1.7.4)	
14. Seat Insert	N/A	
15. Spring (Seat) Material	UNS N07750	
16. Stem Material	ASTM A276 (UNS S31600)	
17. Seat-Stem Seal	Group E (acc. item A.7.1.5.6)	
18. Operator Type	3"	Lever
	4" - 8"	Gearbox
19. Additional Requirement	N/A	
20. Seat Type	Side A: SPE / Side B: SPE	
21. Bore Type	Full Bore	
22. Body Construction	Compact flangeless single body double ball valve. Face to face according ASME B16.10	
23. Cladding or Coating	N/A	
24. Valve Testing	FAT according A.9.3	
25. Notes	All materials described in this datasheet are required for both valve, Needle valve between balls for cavity-pressure relief	

A.12.5 GATE VALVES

Valve Code	VGA-10000-3-D311		VGA-10000-3-N111		VGA-10000-4-D311	
Specs	J12P J12		J40P J40		J12P J12	
1. Valve Type	Gate		Gate		Gate	
2. Sealing Type	Metal to Metal		Metal to Metal		Metal to Metal	
3. Valve Specification Level (VSL)	VSL-3		VSL-3		VSL-4	
4. Obturator Type	Slab		Slab		Slab	
5. Standard	API 6A		API 6A		API 6A	
6. Size Range (NPS)	1" - 2"	1 13/16"	1" - 2"	1 13/16"	1 1/2" - 2"	1 13/16"
	3"	2 1/16"	3"	2 1/16"	3"	2 1/16"
	4"	2 9/16"	4"	2 9/16"	4"	2 9/16"
	6"	4 1/16"	6"	4 1/16"	6"	4 1/16"
	8"	5 1/8"	8"	5 1/8"	8"	5 1/8"
	10"	7 1/16"	10"	7 1/16"	10"	7 1/16"
	12" - 14"	9"	12" - 14"	9"	12" - 14"	9"
7. End Connection	API 6A, studded type 6BX (stud and nuts included)		API 6A, studded type 6BX (stud and nuts included)		API 6A, studded type 6BX (stud and nuts included)	
8. Pressure Class	max. press 10000 psi		max. press 10000 psi		max. press 10000 psi	
9. Temperature	-50°C to 150°C		-100°C to 155°C		-50°C to 150°C	
10. Material Class	Duplex Steel		Nickel Alloys		Duplex Steel	
11. Body Material	ASTM A182 Gr F55		ASTM B564 (UNS N06625)		ASTM A182 Gr F55	
12. TRIM Material	N/A		N/A		N/A	
13. Gate Material	ASTM A182 Gr F55 + Tungsten Carbide (acc. item A.8.2.2.3)		ASTM B564 (UNS N06625) + Tungsten Carbide (acc. item A.8.2.2.3)		ASTM A182 Gr F55 + Tungsten Carbide (acc. item A.8.2.2.3)	
14. Seat Material	ASTM A182 Gr F55 + Tungsten Carbide (acc. item A.8.2.2.3)		ASTM B564 (UNS N06625) + Tungsten Carbide (acc. item A.8.2.2.3)		ASTM A182 Gr F55 + Tungsten Carbide (acc. item A.8.2.2.3)	
15. Seat Insert Material	N/A		N/A		N/A	
16. Stem Material	ASTM A276 (UNS S32760)		ASTM B637 (UNS N07718)		ASTM A276 (UNS S32760)	
17. Stem Seal Material	According manufacturer standard, fitted to service conditions		According manufacturer standard, fitted to service conditions		According manufacturer standard, fitted to service conditions	
18. Seat Seal Material	PEEK+UNS R30003 (Elgiloy)		PEEK+UNS R30003 (Elgiloy)		PEEK+UNS R30003 (Elgiloy)	
19. Operator Type	Gearbox		Gearbox		Actuated	
20. Additional Requirement	Fire tested acc. API 6FA		Fire tested acc. API 6FA		Fire tested acc. API 6FA	
21. Body Construction	According manufacturer standard		According manufacturer standard		According manufacturer standard	
22. Product Testing	FAT according A.9.3		FAT according A.9.3		FAT according A.9.3	
23. Cladding or Coating	N/A		N/A		N/A	
24. Stem Design	Non rising stem		Non rising stem		Non rising stem	

Valve Code	VGA-1500-1-S231		VGA-1500-2-S231		VGA-1501-1-C101	VGA-1501-1-S201
Specs	G3		G3		F10	F3 G3
1. Valve Type	Gate		Gate		Gate	Gate
2. Sealing Type	Metal to Metal		Metal to Metal		Metal to Metal	Metal to Metal
3. Valve Specification Level (VSL)	VSL-1		VSL-2		VSL-1	VSL-1
4. Obturator Type	Flexible Wedge, one piece		Flexible Wedge, one piece		Solid Wedge	Solid Wedge
5. Standard	API 600		API 600		API 602	API 602
6. Size Range (NPS)	2" - 16"		2" - 16"		½" - 1 ½"	½" - 1 ½"
7. End Connection	ASME B16.5, RTJ		ASME B16.5, RTJ		N/A	N/A
8. Pressure Class	1500		1500		1500	1500
9. Temperature	-29°C to 400°C		-46°C to 400°C		-29°C to 400°C	-46°C to 400°C
10. Material Class	Stainless Steel		Stainless Steel		Carbon Steel	Stainless Steel
11. Body Material	ASTM A182 Gr F316		ASTM A182 Gr F316		ASTM A105	ASTM A182 Gr F316/316L
12. TRIM Material	TRIM 16 according API		TRIM 16 according API		TRIM 5 according API	TRIM 16 according API
13. Gate Material	ASTM A182 Gr F316		ASTM A182 Gr F316		ASTM A182 Gr F6a	ASTM A182 Gr F316L
14. Seat Material	Stellite (Co-Cr Alloy acc. item A.8.2.1.2)		Stellite (Co-Cr Alloy acc. item A.8.2.1.2)		Stellite (Co-Cr Alloy acc. item A.8.2.1.2)	Stellite (Co-Cr Alloy acc. item A.8.2.1.2)
15. Seat Insert Material	N/A		N/A		N/A	N/A
16. Stem Material	ASTM A276 (UNS S31600)		ASTM A276 (UNS S31600)		ASTM A276 (UNS S41000)	ASTM A276 (UNS S31600)
17. Stem Seal Material	Flexible graphite with inconel wire		Flexible graphite with inconel wire		Flexible graphite with inconel wire	Flexible graphite with inconel wire
18. Seat Seal Material	N/A		N/A		N/A	N/A
19. Operator Type	2"	non rising handwheel	2"	non rising handwheel	N/A	N/A
	3" - 16"	Gearbox	3" - 16"	Gearbox	N/A	N/A
20. Additional Requirement	Fire safe design (acc. item A.6.1.5)		Fire safe design (acc. item A.6.1.5)		Fire safe design (acc. item A.6.1.5)	Fire safe design (acc. item A.6.1.5)
21. Body Construction	bolted bonnet		bolted bonnet		bolted bonnet	bolted bonnet
22. Product Testing	FAT according A.9.3		FAT according A.9.3		FAT according A.9.3	FAT according A.9.3
23. Cladding or Coating	N/A		N/A		N/A	N/A
24. Stem Design	Rising Stem OS&Y		Rising Stem OS&Y		Rising Stem OS&Y	Rising Stem OS&Y

Valve Code	VGA-150-1-C101		VGA-150-1-C102		VGA-150-1-D201		VGA-150-1-D301	
Specs	B4 B9 B10 R9B S9B		B4		B11 B16 B26		B12	
1. Valve Type	Gate		Gate		Gate		Gate	
2. Sealing Type	Metal to Metal		Metal to Metal		Metal to Metal		Metal to Metal	
3. Valve Specification Level (VSL)	VSL-1		VSL-1		VSL-1		VSL-1	
4. Obturator Type	Flexible Wedge, one piece		Flexible Wedge, one piece		Flexible Wedge, one piece		Flexible Wedge, one piece	
5. Standard	2" - 24"	API 600	API 600		2" - 24"	API 600	2" - 24"	API 600
	26" - 36"	ASME B16.34	N/A		26" - 32"	ASME B16.34	26" - 36"	ASME B16.34
6. Size Range (NPS)	2" - 36"		2" - 24"		2" - 32"		2" - 36"	
7. End Connection	2" - 24"	ASME B16.5, RF	ASME B16.5, RF		2" - 24"	ASME B16.5, RF	2" - 24"	ASME B16.5, RF
	26" - 36"	ASME B16.47 Series A, RF	N/A		26" - 32"	ASME B16.47 Series A, RF	26" - 36"	ASME B16.47 Series A, RF
8. Pressure Class	150		150		150		150	
9. Temperature	-29°C to 400°C		-29°C to 400°C		-50°C to 150°C		-50°C to 150°C	
10. Material Class	Carbon Steel		Carbon Steel		Duplex Steel		Duplex Steel	
11. Body Material	ASTM A105 or ASTM A216 Gr WCB		ASTM A105 or ASTM A216 Gr WCB		ASTM A182 Gr F51 or ASTM A995 Gr 4a		ASTM A182 Gr F55 or ASTM A995 Gr 6a	
12. TRIM Material	TRIM 5 according API		TRIM 8 according API		N/A		N/A	
13. Gate Material	AISI 410		Stellite (Co-Cr Alloy acc. Item A.8.2.1.2)		(A182 F51 or A995 4A) + E/ERCoCr		(A182 F55 or A995 6A) + E/ERCoCr	
14. Seat Material	Stellite (Co-Cr Alloy acc. item A.8.2.1.2)		Stellite (Co-Cr Alloy acc. item A.8.2.1.2)		Duplex (UNS S31803)		Super Duplex (UNS S32760)	
15. Seat Insert Material	N/A		N/A		N/A		N/A	
16. Stem Material	ASTM A276 (UNS S41000)		ASTM A276 (UNS S41000)		ASTM A276 (UNS S31803)		ASTM A276 (UNS S32760)	
17. Stem Seal Material	Flexible graphite with inconel wire		Flexible graphite with inconel wire		Flexible graphite with inconel wire		Flexible graphite with inconel wire	
18. Seat Seal Material	N/A		N/A		N/A		N/A	
19. Operator Type	2" - 10"	non rising handwheel	2" - 10"	non rising handwheel	2" - 10"	non rising handwheel	2" - 10"	non rising handwheel
	12" - 36"	Gearbox	12" - 24"	Gearbox	12" - 32"	Gearbox	12" - 36"	Gearbox
20. Additional Requirement	Fire safe design (acc. item A.6.1.5)		Fire safe design (acc. item A.6.1.5)		Fire safe design (acc. item A.6.1.5)		Fire safe design (acc. item A.6.1.5)	
21. Body Construction	bolted bonnet		bolted bonnet		bolted bonnet		bolted bonnet	
22. Product Testing	FAT according A.9.3		FAT according A.9.3		FAT according A.9.3		FAT according A.9.3	
23. Cladding or Coating	N/A		N/A		N/A		N/A	
24. Stem Design	Rising Stem OS&Y		Rising Stem OS&Y		Rising Stem OS&Y		Rising Stem OS&Y	

Valve Code	VGA-150-1-S201		VGA-150-1-U301		VGA-150-1-U302		VGA-150-2-C101	
Specs	B3 R3B S3B		B7R B7 S7		B14 B22 B23		B4 B9 B10	
1. Valve Type	Gate		Gate		Gate		Gate	
2. Sealing Type	Metal to Metal		Metal to Metal		Metal to Metal		Metal to Metal	
3. Valve Specification Level (VSL)	VSL-1		VSL-1		VSL-1		VSL-2	
4. Obturator Type	Flexible Wedge, one piece		Flexible Wedge(NPS>=2), one piece		Flexible Wedge(NPS>=2), one piece		Flexible Wedge, one piece	
5. Standard	2" - 24"	API 600	API 600		API 600		2" - 24"	API 600
	26" - 36"	ASME B16.34	N/A		N/A		26" - 36"	ASME B16.34
6. Size Range (NPS)	2" - 36"		1" - 24"		1" - 24"		2" - 36"	
7. End Connection	2" - 24"	ASME B16.5, RF	ASME B16.24, RF		ASME B16.24, FF		2" - 24"	ASME B16.5, RF
	26" - 36"	ASME B16.47 Series A, RF	N/A		N/A		26" - 36"	ASME B16.47 Series A, RF
8. Pressure Class	150		150		150		150	
9. Temperature	-46°C to 400°C		-46°C to 75°C		-46°C to 75°C		-29°C to 400°C	
10. Material Class	Stainless Steel		Uncommon Materials		Uncommon Materials		Carbon Steel	
11. Body Material	ASTM A182 Gr F316 or ASTM A351 Gr CF8M		ASTM B148 (UNS C95800)		ASTM B148 (UNS C95800)		ASTM A105 or ASTM A216 Gr WCB	
12. TRIM Material	TRIM 16 according API		N/A		N/A		TRIM 5 according API	
13. Gate Material	AISI 316		ASTM B148 (UNS C95800)		ASTM B148 (UNS C95800)		AISI 410	
14. Seat Material	Stellite (Co-Cr Alloy acc. item A.8.2.1.2)		ASTM B148 (UNS C95800)		ASTM B148 (UNS C95800)		Stellite (Co-Cr Alloy acc. item A.8.2.1.2)	
15. Seat Insert Material	N/A		N/A		N/A		N/A	
16. Stem Material	ASTM A276 (UNS S31600)		ASTM B150 (UNS C63200)		ASTM B150 (UNS C63200)		ASTM A276 (UNS S41000)	
17. Stem Seal Material	Flexible graphite with inconel wire		PTFE		PTFE		Flexible graphite with inconel wire	
18. Seat Seal Material	N/A		N/A		N/A		N/A	
19. Operator Type	2" - 10"	non rising handwheel	1" - 10"	non rising handwheel	1" - 10"	non rising handwheel	2" - 10"	non rising handwheel
	12" - 36"	Gearbox	12" - 24"	Gearbox	12" - 24"	Gearbox	12" - 36"	Gearbox
20. Additional Requirement	Fire safe design (acc. item A.6.1.5)		N/A		N/A		Fire safe design (acc. item A.6.1.5)	
21. Body Construction	bolted bonnet		bolted bonnet		bolted bonnet		bolted bonnet	
22. Product Testing	FAT according A.9.3		FAT according A.9.3		FAT according A.9.3		FAT according A.9.3	
23. Cladding or Coating	N/A		N/A		N/A		N/A	
24. Stem Design	Rising Stem OS&Y		Rising Stem OS&Y		Rising Stem OS&Y		Rising Stem OS&Y	

Valve Code	VGA-150-2-C102		VGA-150-2-D201		VGA-150-2-S201		VGA-150-2-U301	
Specs	B4 S9B		B11 B16 B26		B3		B7R B7	
1. Valve Type	Gate		Gate		Gate		Gate	
2. Sealing Type	Metal to Metal		Metal to Metal		Metal to Metal		Metal to Metal	
3. Valve Specification Level (VSL)	VSL-2		VSL-2		VSL-2		VSL-2	
4. Obturator Type	Flexible Wedge, one piece		Flexible Wedge, one piece		Flexible Wedge, one piece		Flexible Wedge(NPS>=2), one piece	
5. Standard	API 600		2" - 24"	API 600	2" - 24"	API 600	API 600	
	N/A		26" - 32"	ASME B16.34	26" - 36"	ASME B16.34	N/A	
6. Size Range (NPS)	2" - 24"		2" - 32"		2" - 36"		1" - 24"	
7. End Connection	ASME B16.5, RF		2" - 24"	ASME B16.5, RF	2" - 24"	ASME B16.5, RF	ASME B16.24, RF	
	N/A		26" - 32"	ASME B16.47 Series A, RF	26" - 36"	ASME B16.47 Series A, RF	N/A	
8. Pressure Class	150		150		150		150	
9. Temperature	-29°C to 400°C		-50°C to 150°C		-46°C to 400°C		-46°C to 75°C	
10. Material Class	Carbon Steel		Duplex Steel		Stainless Steel		Uncommon Materials	
11. Body Material	ASTM A105 or ASTM A216 Gr WCB		ASTM A182 Gr F51 or ASTM A995 Gr 4a		ASTM A182 Gr F316 or ASTM A351 Gr CF8M		ASTM B148 (UNS C95800)	
12. TRIM Material	TRIM 8 according API		N/A		TRIM 16 according API		N/A	
13. Gate Material	Stellite (Co-Cr Alloy acc. Item A.8.2.1.2)		(A182 F51 or A995 4A) + E/ERCoCr		AISI 316		ASTM B148 (UNS C95800)	
14. Seat Material	Stellite (Co-Cr Alloy acc. item A.8.2.1.2)		Duplex (UNS S31803)		Stellite (Co-Cr Alloy acc. item A.8.2.1.2)		ASTM B148 (UNS C95800)	
15. Seat Insert Material	N/A		N/A		N/A		N/A	
16. Stem Material	ASTM A276 (UNS S41000)		ASTM A276 (UNS S31803)		ASTM A276 (UNS S31600)		ASTM B150 (UNS C63200)	
17. Stem Seal Material	Flexible graphite with inconel wire		Flexible graphite with inconel wire		Flexible graphite with inconel wire		PTFE	
18. Seat Seal Material	N/A		N/A		N/A		N/A	
19. Operator Type	2" - 10"	non rising handwheel	2" - 10"	non rising handwheel	2" - 10"	non rising handwheel	1" - 10"	non rising handwheel
	12" - 24"	Gearbox	12" - 32"	Gearbox	12" - 36"	Gearbox	12" - 24"	Gearbox
20. Additional Requirement	Fire safe design (acc. item A.6.1.5)		Fire safe design (acc. item A.6.1.5)		Fire safe design (acc. item A.6.1.5)		N/A	
21. Body Construction	bolted bonnet		bolted bonnet		bolted bonnet		bolted bonnet	
22. Product Testing	FAT according A.9.3		FAT according A.9.3		FAT according A.9.3		FAT according A.9.3	
23. Cladding or Coating	N/A		N/A		N/A		N/A	
24. Stem Design	Rising Stem OS&Y		Rising Stem OS&Y		Rising Stem OS&Y		Rising Stem OS&Y	

Valve Code	VGA-150-2-U302		VGA-2501-1-D201		VGA-2501-2-D301		VGA-2510-2-C131	
Specs	B14 B22 B23		H16		H12P H12		H10	
1. Valve Type	Gate		Gate		Gate		Gate	
2. Sealing Type	Metal to Metal		Metal to Metal		Metal to Metal		Metal to Metal	
3. Valve Specification Level (VSL)	VSL-2		VSL-1		VSL-2		VSL-2	
4. Obturator Type	Flexible Wedge(NPS>=2), one piece		Solid Wedge		Solid Wedge		Flexible Wedge, one piece	
5. Standard	API 600		N/A		N/A		N/A	
6. Size Range (NPS)	1" - 24"		1" - 1 ½"		1" - 1 ½"		2" - 12"	
7. End Connection	ASME B16.24, FF		N/A		N/A		IX	
8. Pressure Class	150		2500		2500		2500	
9. Temperature	-46°C to 75°C		-50°C to 150°C		-50°C to 150°C		-29°C to 400°C	
10. Material Class	Uncommon Materials		Duplex Steel		Duplex Steel		Carbon Steel	
11. Body Material	ASTM B148 (UNS C95800)		ASTM A182 Gr F51		ASTM A182 Gr F55		ASTM A105	
12. TRIM Material	N/A		N/A		N/A		TRIM 5 according API	
13. Gate Material	ASTM B148 (UNS C95800)		ASTM A182 Gr F51		ASTM A182 Gr F55		ASTM A182 Gr F6a	
14. Seat Material	ASTM B148 (UNS C95800)		ASTM A182 Gr F51		ASTM A182 Gr F55		Stellite (Co-Cr Alloy acc. item A.8.2.1.2)	
15. Seat Insert Material	N/A		N/A		N/A		N/A	
16. Stem Material	ASTM B150 (UNS C63200)		ASTM A276 (UNS S31803)		ASTM A276 (UNS S32760)		ASTM A276 (UNS S41000)	
17. Stem Seal Material	PTFE		Flexible graphite with inconel wire		Flexible graphite with inconel wire		Flexible graphite with inconel wire	
18. Seat Seal Material	N/A		N/A		N/A		N/A	
19. Operator Type	1" - 10"	non rising handwheel	N/A		N/A		2" non rising handwheel	
	12" - 24"	Gearbox	N/A		N/A		3" - 12" Gearbox	
20. Additional Requirement	N/A		Fire safe design (acc. item A.6.1.5)		Fire safe design (acc. item A.6.1.5)		Fire safe design (acc. item A.6.1.5)	
21. Body Construction	bolted bonnet		bolted bonnet		bolted bonnet		bolted bonnet	
22. Product Testing	FAT according A.9.3		FAT according A.9.3		FAT according A.9.3		FAT according A.9.3	
23. Cladding or Coating	N/A		N/A		N/A		N/A	
24. Stem Design	Rising Stem OS&Y		Rising Stem OS&Y		Rising Stem OS&Y		Rising Stem OS&Y	

Valve Code	VGA-2510-2-D231		VGA-300-1-C101		VGA-300-1-C102		VGA-300-1-D201	
Specs	H16		C4 C9 C10 R9C S9C		C4		C11 C16	
1. Valve Type	Gate		Gate		Gate		Gate	
2. Sealing Type	Metal to Metal		Metal to Metal		Metal to Metal		Metal to Metal	
3. Valve Specification Level (VSL)	VSL-2		VSL-1		VSL-1		VSL-1	
4. Obturator Type	Flexible Wedge, one piece		Flexible Wedge, one piece		Flexible Wedge, one piece		Flexible Wedge, one piece	
5. Standard	API 600		2" - 24"	API 600	API 600		API 600	
	N/A		26" - 32"	ASME B16.34	N/A		N/A	
6. Size Range (NPS)	2" - 12"		2" - 32"		2" - 24"		2" - 24"	
7. End Connection	ISO 27509, IX		RF		RF		RF	
8. Pressure Class	2500		300		300		300	
9. Temperature	-50°C to 150°C		-29°C to 400°C		-29°C to 400°C		-50°C to 150°C	
10. Material Class	Duplex Steel		Carbon Steel		Carbon Steel		Duplex Steel	
11. Body Material	ASTM A182 Gr F51		ASTM A105 or ASTM A216 Gr WCB		ASTM A105 or ASTM A216 Gr WCB		ASTM A182 Gr F51 or ASTM A995 Gr 4a	
12. TRIM Material	N/A		TRIM 5 according API		TRIM 8 according API		N/A	
13. Gate Material	(A182 F51 or A995 4A) + E/ERCoCr		AISI 410		Stellite (Co-Cr Alloy acc. Item A.8.2.1.2)		(A182 F51 or A995 4A) + E/ERCoCr	
14. Seat Material	ASTM A182 Gr F51		Stellite (Co-Cr Alloy acc. item A.8.2.1.2)		Stellite (Co-Cr Alloy acc. item A.8.2.1.2)		Duplex (UNS S31803)	
15. Seat Insert Material	N/A		N/A		N/A		N/A	
16. Stem Material	ASTM A276 (UNS S31803)		ASTM A276 (UNS S41000)		ASTM A276 (UNS S41000)		ASTM A276 (UNS S31803)	
17. Stem Seal Material	Flexible graphite with inconel wire		Flexible graphite with inconel wire		Flexible graphite with inconel wire		Flexible graphite with inconel wire	
18. Seat Seal Material	N/A		N/A		N/A		N/A	
19. Operator Type	2"	non rising handwheel	2" - 8"	non rising handwheel	2" - 8"	non rising handwheel	2" - 8"	non rising handwheel
	3" - 12"	Gearbox	10" - 32"	Gearbox	10" - 24"	Gearbox	10" - 24"	Gearbox
20. Additional Requirement	Fire safe design (acc. item A.6.1.5)		Fire safe design (acc. item A.6.1.5)		Fire safe design (acc. item A.6.1.5)		Fire safe design (acc. item A.6.1.5)	
21. Body Construction	bolted bonnet		bolted bonnet		bolted bonnet		bolted bonnet	
22. Product Testing	FAT according A.9.3		FAT according A.9.3		FAT according A.9.3		FAT according A.9.3	
23. Cladding or Coating	N/A		N/A		N/A		N/A	
24. Stem Design	Rising Stem OS&Y		Rising Stem OS&Y		Rising Stem OS&Y		Rising Stem OS&Y	

Valve Code	VGA-300-1-D301		VGA-300-1-S201		VGA-300-1-U301		VGA-300-2-C101	
Specs	C12		C3 R3C S3C		C23		C4 C9 C10	
1. Valve Type	Gate		Gate		Gate		Gate	
2. Sealing Type	Metal to Metal		Metal to Metal		Metal to Metal		Metal to Metal	
3. Valve Specification Level (VSL)	VSL-1		VSL-1		VSL-1		VSL-2	
4. Obturator Type	Flexible Wedge, one piece		Flexible Wedge, one piece		Flexible Wedge(NPS>=2), one piece		Flexible Wedge, one piece	
5. Standard	2" - 24"	API 600	2" - 24"	API 600	API 600		2" - 24"	API 600
	26" - 30"	ASME B16.34	26" - 30"	ASME B16.34	N/A		26" - 32"	ASME B16.34
6. Size Range (NPS)	2" - 30"		2" - 30"		1" - 12"		2" - 32"	
7. End Connection	2" - 24"	ASME B16.5, RF	2" - 24"	ASME B16.5, RF	ASME B16.24, RF		2" - 24"	ASME B16.5, RF
	26" - 30"	ASME B16.47 Series A, RF	26" - 30"	ASME B16.47 Series A, RF	N/A		26" - 32"	ASME B16.47 Series A, RF
8. Pressure Class	300		300		150, 300		300	
9. Temperature	-50°C to 150°C		-46°C to 400°C		-46°C to 75°C		-29°C to 400°C	
10. Material Class	Duplex Steel		Stainless Steel		Uncommon Materials		Carbon Steel	
11. Body Material	ASTM A182 Gr F55 or ASTM A995 Gr 6a		ASTM A182 Gr F316 or ASTM A351 Gr CF8M		ASTM B148 (UNS C95800)		ASTM A105 or ASTM A216 Gr WCB	
12. TRIM Material	N/A		TRIM 16 according API		N/A		TRIM 5 according API	
13. Gate Material	(A182 F55 or A995 6A) + E/ERCoCr		AISI 316		ASTM B148 (UNS C95800)		AISI 410	
14. Seat Material	Super Duplex (UNS S32760)		Stellite (Co-Cr Alloy acc. item A.8.2.1.2)		ASTM B148 (UNS C95800)		Stellite (Co-Cr Alloy acc. item A.8.2.1.2)	
15. Seat Insert Material	N/A		N/A		N/A		N/A	
16. Stem Material	ASTM A276 (UNS S32760)		ASTM A276 (UNS S31600)		ASTM B150 (UNS C63200)		ASTM A276 (UNS S41000)	
17. Stem Seal Material	Flexible graphite with inconel wire		Flexible graphite with inconel wire		PTFE		Flexible graphite with inconel wire	
18. Seat Seal Material	N/A		N/A		N/A		N/A	
19. Operator Type	2" - 8"	non rising handwheel	2" - 8"	non rising handwheel	1" - 10"	non rising handwheel	2" - 8"	non rising handwheel
	10" - 30"	Gearbox	10" - 30"	Gearbox	12"	Gearbox	10" - 32"	Gearbox
20. Additional Requirement	Fire safe design (acc. item A.6.1.5)		Fire safe design (acc. item A.6.1.5)		N/A		Fire safe design (acc. item A.6.1.5)	
21. Body Construction	bolted bonnet		bolted bonnet		bolted bonnet		bolted bonnet	
22. Product Testing	FAT according A.9.3		FAT according A.9.3		FAT according A.9.3		FAT according A.9.3	
23. Cladding or Coating	N/A		N/A		N/A		N/A	
24. Stem Design	Rising Stem OS&Y		Rising Stem OS&Y		Rising Stem OS&Y		Rising Stem OS&Y	

Valve Code	VGA-300-2-C102		VGA-300-2-D201		VGA-600-1-C131		VGA-600-1-D231	
Specs	C4 S9C		C11 C16		E9 E10		E16	
1. Valve Type	Gate		Gate		Gate		Gate	
2. Sealing Type	Metal to Metal		Metal to Metal		Metal to Metal		Metal to Metal	
3. Valve Specification Level (VSL)	VSL-2		VSL-2		VSL-1		VSL-1	
4. Obturator Type	Flexible Wedge, one piece		Flexible Wedge, one piece		Flexible Wedge, one piece		Flexible Wedge, one piece	
5. Standard	API 600		API 600		N/A		N/A	
6. Size Range (NPS)	2" - 24"		2" - 24"		2" - 24"		2" - 16"	
7. End Connection	ASME B16.5, RF		ASME B16.5, RF		ASME B16.5, RF		ASME B16.5, RF	
8. Pressure Class	300		300		600		600	
9. Temperature	-29°C to 400°C		-50°C to 150°C		-29°C to 400°C		-50°C to 150°C	
10. Material Class	Carbon Steel		Duplex Steel		Carbon Steel		Duplex Steel	
11. Body Material	ASTM A105 or ASTM A216 Gr WCB		ASTM A182 Gr F51 or ASTM A995 Gr 4a		ASTM A105 or ASTM A216 Gr WCB		ASTM A182 Gr F51 or ASTM A995 Gr 4a	
12. TRIM Material	TRIM 8 according API		N/A		TRIM 5 according API		N/A	
13. Gate Material	Stellite (Co-Cr Alloy acc. Item A.8.2.1.2)		(A182 F51 or A995 4A) + E/ERCoCr		AISI 410		(A182 F51 or A995 4A) + E/ERCoCr	
14. Seat Material	Stellite (Co-Cr Alloy acc. item A.8.2.1.2)		Duplex (UNS S31803)		Stellite (Co-Cr Alloy acc. item A.8.2.1.2)		Duplex (UNS S31803)	
15. Seat Insert Material	N/A		N/A		N/A		N/A	
16. Stem Material	ASTM A276 (UNS S41000)		ASTM A276 (UNS S31803)		ASTM A276 (UNS S41000)		ASTM A276 (UNS S31803)	
17. Stem Seal Material	Flexible graphite with inconel wire		Flexible graphite with inconel wire		Flexible graphite with inconel wire		Flexible graphite with inconel wire	
18. Seat Seal Material	N/A		N/A		N/A		N/A	
19. Operator Type	2" - 8"	non rising handwheel	2" - 8"	non rising handwheel	2" - 4"	non rising handwheel	2" - 4"	non rising handwheel
	10" - 24"	Gearbox	10" - 24"	Gearbox	6" - 24"	Gearbox	6" - 16"	Gearbox
20. Additional Requirement	Fire safe design (acc. item A.6.1.5)		Fire safe design (acc. item A.6.1.5)		Fire safe design (acc. item A.6.1.5)		Fire safe design (acc. item A.6.1.5)	
21. Body Construction	bolted bonnet		bolted bonnet		bolted bonnet		bolted bonnet	
22. Product Testing	FAT according A.9.3		FAT according A.9.3		FAT according A.9.3		FAT according A.9.3	
23. Cladding or Coating	N/A		N/A		N/A		N/A	
24. Stem Design	Rising Stem OS&Y		Rising Stem OS&Y		Rising Stem OS&Y		Rising Stem OS&Y	

Valve Code	VGA-600-1-S231		VGA-600-2-C131		VGA-801-1-C101		VGA-801-1-C102	
Specs	E3		E9 E10		B4 B9 B10 C9 C10 E9 E10 R9B R9C S9B S9C		B4 C4 S9B S9C	
1. Valve Type	Gate		Gate		Gate		Gate	
2. Sealing Type	Metal to Metal		Metal to Metal		Metal to Metal		Metal to Metal	
3. Valve Specification Level (VSL)	VSL-1		VSL-2		VSL-1		VSL-1	
4. Obturator Type	Flexible Wedge, one piece		Flexible Wedge, one piece		Solid Wedge		Solid Wedge	
5. Standard	API 600		API 600		API 602		API 602	
6. Size Range (NPS)	2" - 16"		2" - 24"		½" - 1 ½"		½" - 1 ½"	
7. End Connection	ASME B16.5, RF		ASME B16.5, RF		N/A		N/A	
8. Pressure Class	600		600		800		800	
9. Temperature	-46°C to 400°C		-29°C to 400°C		-29°C to 400°C		-29°C to 400°C	
10. Material Class	Stainless Steel		Carbon Steel		Carbon Steel		Carbon Steel	
11. Body Material	ASTM A182 Gr F316 or ASTM A351 Gr CF8M		ASTM A105 or ASTM A216 Gr WCB		ASTM A105		ASTM A105	
12. TRIM Material	TRIM 16 according API		TRIM 5 according API		TRIM 5 according API		TRIM 8 according API	
13. Gate Material	AISI 316		AISI 410		AISI 410		Stellite (Co-Cr Alloy acc. Item A.8.2.1.2)	
14. Seat Material	Stellite (Co-Cr Alloy acc. item A.8.2.1.2)		Stellite (Co-Cr Alloy acc. item A.8.2.1.2)		Stellite (Co-Cr Alloy acc. item A.8.2.1.2)		Stellite (Co-Cr Alloy acc. item A.8.2.1.2)	
15. Seat Insert Material	N/A		N/A		N/A		N/A	
16. Stem Material	ASTM A276 (UNS S31600)		ASTM A276 (UNS S41000)		ASTM A276 (UNS S41000)		ASTM A276 (UNS S41000)	
17. Stem Seal Material	Flexible graphite with inconel wire		Flexible graphite with inconel wire		Flexible graphite with inconel wire		Flexible graphite with inconel wire	
18. Seat Seal Material	N/A		N/A		N/A		N/A	
19. Operator Type	2" - 4"	non rising handwheel	2" - 4"	non rising handwheel	N/A	N/A	N/A	N/A
	6" - 16"	Gearbox	6" - 24"	Gearbox	N/A	N/A	N/A	N/A
20. Additional Requirement	Fire safe design (acc. item A.6.1.5)		Fire safe design (acc. item A.6.1.5)		Fire safe design (acc. item A.6.1.5)		Fire safe design (acc. item A.6.1.5)	
21. Body Construction	bolted bonnet		bolted bonnet		bolted bonnet		bolted bonnet	
22. Product Testing	FAT according A.9.3		FAT according A.9.3		FAT according A.9.3		FAT according A.9.3	
23. Cladding or Coating	N/A		N/A		N/A		N/A	
24. Stem Design	Rising Stem OS&Y		Rising Stem OS&Y		Rising Stem OS&Y		Rising Stem OS&Y	

Valve Code	VGA-801-1-D201	VGA-801-1-D301	VGA-801-1-S201	VGA-801-2-C101
Specs	B16 C16 E16	B12 C12	B3 C3 E3 R3B R3C S3B S3C	B4 C4
1. Valve Type	Gate	Gate	Gate	Gate
2. Sealing Type	Metal to Metal	Metal to Metal	Metal to Metal	Metal to Metal
3. Valve Specification Level (VSL)	VSL-1	VSL-1	VSL-1	VSL-2
4. Obturator Type	Solid Wedge	Solid Wedge	Solid Wedge	Solid Wedge
5. Standard	API 602	API 602	API 602	API 602
6. Size Range (NPS)	½" - 1 ½"	½" - 1 ½"	½" - 1 ½"	½" - 1 ½"
7. End Connection	socket weld ends ASME B16.11	socket weld ends ASME B16.11	socket weld ends ASME B16.11	socket weld ends ASME B16.11
8. Pressure Class	800	800	800	800
9. Temperature	-50°C to 150°C	-50°C to 150°C	-46°C to 400°C	-29°C to 400°C
10. Material Class	Duplex Steel	Duplex Steel	Stainless Steel	Carbon Steel
11. Body Material	ASTM A182 Gr F51	ASTM A182 Gr F55	ASTM A182 Gr F316/316L	ASTM A105
12. TRIM Material	N/A	N/A	TRIM 16 according API	TRIM 5 according API
13. Gate Material	Duplex (UNS S31803)	Super Duplex (UNS S32760)	AISI 316L	Stellite (Co-Cr Alloy acc. Item A.8.2.1.2)
14. Seat Material	Duplex (UNS S31803)	Super Duplex (UNS S32760)	Stellite (Co-Cr Alloy acc. item A.8.2.1.2)	Stellite (Co-Cr Alloy acc. item A.8.2.1.2)
15. Seat Insert Material	N/A	N/A	N/A	N/A
16. Stem Material	ASTM A276 (UNS S31803)	ASTM A276 (UNS S32760)	ASTM A276 (UNS S31600)	ASTM A276 (UNS S41000)
17. Stem Seal Material	Flexible graphite with inconel wire	Flexible graphite with inconel wire	Flexible graphite with inconel wire	Flexible graphite with inconel wire
18. Seat Seal Material	N/A	N/A	N/A	N/A
19. Operator Type	non rising handwheel	non rising handwheel	non rising handwheel	non rising handwheel
20. Additional Requirement	Fire safe design (acc. item A.6.1.5)	Fire safe design (acc. item A.6.1.5)	Fire safe design (acc. item A.6.1.5)	Fire safe design (acc. item A.6.1.5)
21. Body Construction	bolted bonnet	bolted bonnet	bolted bonnet	bolted bonnet
22. Product Testing	FAT according A.9.3	FAT according A.9.3	FAT according A.9.3	FAT according A.9.3
23. Cladding or Coating	N/A	N/A	N/A	N/A
24. Stem Design	Rising Stem OS&Y	Rising Stem OS&Y	Rising Stem OS&Y	Rising Stem OS&Y

OFFSHORE PRODUCTION FACILITIES
PIPING SPECIFICATION FOR TOPSIDE

Valve Code	VGA-900-1-C131		VGA-900-1-S231	
Specs	F10		F3	
1. Valve Type	Gate		Gate	
2. Sealing Type	Metal to Metal		Metal to Metal	
3. Valve Specification Level (VSL)	VSL-1		VSL-1	
4. Obturator Type	Flexible Wedge, one piece		Flexible Wedge, one piece	
5. Standard	API 600		API 600	
6. Size Range (NPS)	2" - 24"		2" - 18"	
7. End Connection	ASME B16.5, RTJ		ASME B16.5, RTJ	
8. Pressure Class	900		900	
9. Temperature	-29°C to 400°C		-46°C to 400°C	
10. Material Class	Carbon Steel		Stainless Steel	
11. Body Material	ASTM A105 or ASTM A216 Gr WCB		ASTM A182 Gr F316 or ASTM A351 Gr CF8M	
12. TRIM Material	TRIM 5 according API		TRIM 16 according API	
13. Gate Material	AISI 410		AISI 316	
14. Seat Material	Stellite (Co-Cr Alloy acc. item A.8.2.1.2)		Stellite (Co-Cr Alloy acc. item A.8.2.1.2)	
15. Seat Insert Material	N/A		N/A	
16. Stem Material	ASTM A276 (UNS S41000)		ASTM A276 (UNS S31600)	
17. Stem Seal Material	Flexible graphite with inconel wire		Flexible graphite with inconel wire	
18. Seat Seal Material	N/A		N/A	
19. Operator Type	2" - 3"	non rising handwheel	2" - 3"	non rising handwheel
	4" - 24"	Gearbox	4" - 18"	Gearbox
20. Additional Requirement	Fire safe design (acc. item A.6.1.5)		Fire safe design (acc. item A.6.1.5)	
21. Body Construction	bolted bonnet		bolted bonnet	
22. Product Testing	FAT according A.9.3		FAT according A.9.3	
23. Cladding or Coating	N/A		N/A	
24. Stem Design	Rising Stem OS&Y		Rising Stem OS&Y	

A.12.6 GLOBE VALVES

Valve Code	VGL-10000-2-D301	VGL-10000-2-N101	VGL-1500-2-S201		VGL-1500-2-S202	
Specs	J12	J40	G3		G3	
1. Valve Type	Globe	Globe	Globe		Globe	
2. Sealing Type	Metal to Metal	Metal to Metal	Metal to Metal		Metal to Metal	
3. Valve Specification Level (VSL)	VSL-2	VSL-2	VSL-2		VSL-2	
4. Obturator Type	Bevelled Disc	Bevelled Disc	Bevelled Disc		Bevelled Disc	
5. Standard	API 6A	API 6A	BS 1873		BS 1873	
6. Size Range (NPS)	1" - 6"	1" - 6"	2" - 14"		2" - 14"	
7. End Connection	API 6A, studded type 6BX (stud and nuts included)	API 6A, studded type 6BX (stud and nuts included)	ASME B16.5, RTJ		ASME B16.5, RTJ	
8. Pressure Class	max. press 10000 psi	max. press 10000 psi	1500		1500	
9. Temperature	-50°C to 150°C	-100°C to 150°C	-46°C to 400°C		-100°C to 400°C	
10. Material Class	Duplex Steel	Nickel Alloys	Stainless Steel		Stainless Steel	
11. Body Material	ASTM A182 Gr F55	ASTM B564 (UNS N06625)	ASTM A182 Gr F316		ASTM A182 Gr F316	
12. TRIM Material	N/A	N/A	N/A		N/A (Low Temperature Stem)	
13. Obturator Material	ASTM A182 Gr F55	ASTM B564 (UNS N06625)	ASTM A182 Gr F316		ASTM A182 Gr F316	
14. Seat Material	ASTM A182 Gr F55	ASTM B564 (UNS N06625)	Stellite (Co-Cr Alloy acc. item A.8.2.1.2)		Stellite (Co-Cr Alloy acc. item A.8.2.1.2)	
15. Stem Material	ASTM A276 (UNS S32760)	ASTM B637 (UNS N07718)	ASTM A564 Type 630 H1150 (UNS S17400)		ASTM B637 (UNS N07718)	
16. Seat-Stem Seal Material	According manufacturer standard, fitted to service conditions	According manufacturer standard, fitted to service conditions	Flexible graphite with inconel wire		Flexible graphite with inconel wire	
17. Operator Type	Gearbox	Gearbox	2"	Rising Handwheel	2"	Rising Handwheel
	N/A	N/A	3" - 14"	Gearbox	3" - 14"	Gearbox
18. Stem Construction	outside screw stem	outside screw stem	outside screw stem		outside screw stem	
19. Bonnet Construction	According manufacturer standard	According manufacturer standard	bolted bonnet		bolted bonnet	
20. Product testing	FAT according A.9.3	FAT according A.9.3	FAT according A.9.3		FAT according A.9.3	
21. Coating or Cladding	N/A	N/A	N/A		N/A	
22. Notes	N/A	N/A	N/A		N/A	

Valve Code	VGL-150-1-C101		VGL-150-1-C102		VGL-150-1-C201		VGL-150-1-D201	
Specs	B9 B10 R9B S9B		B4		B6 B19		B11 B16 B26	
1. Valve Type	Globe		Globe		Globe		Globe	
2. Sealing Type	Metal to Metal		Metal to Metal		Metal to Metal		Metal to Metal	
3. Valve Specification Level (VSL)	VSL-1		VSL-1		VSL-1		VSL-1	
4. Obturator Type	Bevelled Disc		Bevelled Disc		Bevelled Disc		Bevelled Disc	
5. Standard	BS 1873		BS 1873		BS 1873		BS 1873	
6. Size Range (NPS)	2" - 20"		2" - 18"		2" - 18"		2" - 18"	
7. End Connection	ASME B16.5, RF		ASME B16.5, RF		ASME B16.5, RF		ASME B16.5, RF	
8. Pressure Class	150		150		150		150	
9. Temperature	-29°C to 400°C		-29°C to 400°C		-46°C to 345°C		-46°C to 150°C	
10. Material Class	Carbon Steel		Carbon Steel		Carbon Steel		Duplex Steel	
11. Body Material	ASTM A105 or ASTM A216 Gr WCB		ASTM A105 or ASTM A216 Gr WCB		ASTM A350 Gr LF2 CL1 or ASTM A352 Gr LCB		ASTM A182 Gr F51 or ASTM A995 Gr 4a	
12. TRIM Material	TRIM CR 13 and HF according BS 1873		TRIM HF according BS 1873		N/A		N/A	
13. Obturator Material	AISI 410		Stellite (Co-Cr Alloy acc. item A.8.2.1.2)		AISI 316		Duplex (UNS S31803)	
14. Seat Material	Stellite (Co-Cr Alloy acc. item A.8.2.1.2)		Stellite (Co-Cr Alloy acc. item A.8.2.1.2)		Stellite (Co-Cr Alloy acc. item A.8.2.1.2)		Duplex (UNS S31803)	
15. Stem Material	ASTM A276 (UNS S41000)		ASTM A276 (UNS S41000)		ASTM A564 Type 630 H1150 (UNS S17400)		ASTM A276 (UNS S31803)	
16. Seat-Stem Seal Material	Flexible graphite with inconel wire		Flexible graphite with inconel wire		Flexible graphite with inconel wire		Flexible graphite with inconel wire	
17. Operator Type	2" - 6"	Rising Handwheel	2" - 6"	Rising Handwheel	2" - 6"	Rising Handwheel	2" - 6"	Rising Handwheel
	8" - 20"	Gearbox	8" - 18"	Gearbox	8" - 18"	Gearbox	8" - 18"	Gearbox
18. Stem Construction	outside screw stem		outside screw stem		outside screw stem		outside screw stem	
19. Bonnet Construction	bolted bonnet		bolted bonnet		bolted bonnet		bolted bonnet	
20. Product testing	FAT according A.9.3		FAT according A.9.3		FAT according A.9.3		FAT according A.9.3	
21. Coating or Cladding	N/A		N/A		N/A		N/A	
22. Notes	N/A		N/A		N/A		N/A	

Valve Code	VGL-150-1-D301		VGL-150-1-S201		VGL-150-1-U301		VGL-150-1-U302	
Specs	B12		B3 R3B S3B		B7R B7 S7		B14 B22 B23	
1. Valve Type	Globe		Globe		Globe		Globe	
2. Sealing Type	Metal to Metal		Metal to Metal		Metal to Metal		Metal to Metal	
3. Valve Specification Level (VSL)	VSL-1		VSL-1		VSL-1		VSL-1	
4. Obturator Type	Bevelled Disc		Bevelled Disc		Bevelled Disc		Bevelled Disc	
5. Standard	BS 1873		BS 1873		BS 1873		BS 1873	
6. Size Range (NPS)	2" - 18"		2" - 18"		2" - 18"		2" - 18"	
7. End Connection	ASME B16.5, RF		ASME B16.5, RF		ASME B16.5, RF		ASME B16.24, FF	
8. Pressure Class	150		150		150		150	
9. Temperature	-46°C to 150°C		-29°C to 400°C		-46°C to 75°C		0°C to 75°C	
10. Material Class	Duplex Steel		Stainless Steel		Uncommon Materials		Uncommon Materials	
11. Body Material	ASTM A182 Gr F55 or ASTM A995 Gr 6a		ASTM A182 Gr F316 or ASTM A351 Gr CF8M		ASTM B148 (UNS C95800)		ASTM B148 (UNS C95800)	
12. TRIM Material	N/A		N/A		N/A		N/A	
13. Obturator Material	Super Duplex (UNS S32760)		AISI 316		ASTM B148 (UNS C95800)		ASTM B148 (UNS C95800)	
14. Seat Material	Super Duplex (UNS S32760)		Stellite (Co-Cr Alloy acc. item A.8.2.1.2)		ASTM B148 (UNS C95800)		ASTM B148 (UNS C95800)	
15. Stem Material	ASTM A276 (UNS S32760)		ASTM A276 (UNS S41000)		ASTM B150 (UNS C63200)		ASTM B150 (UNS C63200)	
16. Seat-Stem Seal Material	Flexible graphite with inconel wire		Flexible graphite with inconel wire		According manufacturer standard, fitted to service conditions		According manufacturer standard, fitted to service conditions	
17. Operator Type	2" - 6"	Rising Handwheel	2" - 6"	Rising Handwheel	2" - 6"	Rising Handwheel	2" - 6"	Rising Handwheel
	8" - 18"	Gearbox						
18. Stem Construction	outside screw stem		outside screw stem		outside screw stem		outside screw stem	
19. Bonnet Construction	bolted bonnet		bolted bonnet		bolted bonnet		bolted bonnet	
20. Product testing	FAT according A.9.3		FAT according A.9.3		FAT according A.9.3		FAT according A.9.3	
21. Coating or Cladding	N/A		N/A		N/A		N/A	
22. Notes	N/A		N/A		N/A		N/A	

Valve Code	VGL-150-2-C101		VGL-150-2-C102		VGL-150-2-C201		VGL-150-2-C501	
Specs	B9 B10		B4 S9B		B6 B19		B30	
1. Valve Type	Globe		Globe		Globe		Globe	
2. Sealing Type	Metal to Metal		Metal to Metal		Metal to Metal		Metal to Metal	
3. Valve Specification Level (VSL)	VSL-2		VSL-2		VSL-2		VSL-2	
4. Obturator Type	Bevelled Disc		Bevelled Disc		Bevelled Disc		Bevelled Disc	
5. Standard	BS 1873		BS 1873		BS 1873		BS 1873	
6. Size Range (NPS)	2" - 20"		2" - 18"		2" - 18"		2" - 20"	
7. End Connection	ASME B16.5, RF		ASME B16.5, RF		ASME B16.5, RF		ASME B16.5, RF	
8. Pressure Class	150		150		150		150	
9. Temperature	-29°C to 400°C		-29°C to 400°C		-46°C to 345°C		-29°C to 400°C	
10. Material Class	Carbon Steel		Carbon Steel		Carbon Steel		Carbon Steel	
11. Body Material	ASTM A105 or ASTM A216 Gr WCB		ASTM A105 or ASTM A216 Gr WCB		ASTM A350 Gr LF2 CL1 or ASTM A352 Gr LCB		ASTM A105 or ASTM A216 Gr WCB + Inconel 625 weld overlay (acc. item A.7.1.7.3)	
12. TRIM Material	TRIM CR 13 and HF according BS 1873		TRIM HF according BS 1873		N/A		N/A	
13. Obturator Material	AISI 410		Stellite (Co-Cr Alloy acc. item A.8.2.1.2)		AISI 316		ASTM A105 + Inconel 625 weld overlay (acc. item A.7.1.7.3)	
14. Seat Material	Stellite (Co-Cr Alloy acc. item A.8.2.1.2)		Stellite (Co-Cr Alloy acc. item A.8.2.1.2)		Stellite (Co-Cr Alloy acc. item A.8.2.1.2)		ASTM A105 + Inconel 625 weld overlay (acc. item A.7.1.7.3)	
15. Stem Material	ASTM A276 (UNS S41000)		ASTM A276 (UNS S41000)		ASTM A564 Type 630 H1150 (UNS S17400)		ASTM B637 (UNS N07718)	
16. Seat-Stem Seal Material	Flexible graphite with inconel wire		Flexible graphite with inconel wire		Flexible graphite with inconel wire		Flexible graphite with inconel wire	
17. Operator Type	2" - 6"	Rising Handwheel	2" - 6"	Rising Handwheel	2" - 6"	Rising Handwheel	2" - 6"	Rising Handwheel
	8" - 20"	Gearbox	8" - 18"	Gearbox	8" - 18"	Gearbox	8" - 20"	Gearbox
18. Stem Construction	outside screw stem		outside screw stem		outside screw stem		outside screw stem	
19. Bonnet Construction	bolted bonnet		bolted bonnet		bolted bonnet		bolted bonnet	
20. Product testing	FAT according A.9.3		FAT according A.9.3		FAT according A.9.3		FAT according A.9.3	
21. Coating or Cladding	N/A		N/A		N/A		Full clad - Inconel 625 weld overlay on all wetted parts	
22. Notes	N/A		N/A		N/A		N/A	

Valve Code	VGL-150-2-D101		VGL-150-2-D201		VGL-150-2-S201		VGL-150-2-U301	
Specs	B11 B26		B11 B16 B26		B3		B7R B7	
1. Valve Type	Globe		Globe		Globe		Globe	
2. Sealing Type	Metal to Metal		Metal to Metal		Metal to Metal		Metal to Metal	
3. Valve Specification Level (VSL)	VSL-2		VSL-2		VSL-2		VSL-2	
4. Obturator Type	Bevelled Disc		Bevelled Disc		Bevelled Disc		Bevelled Disc	
5. Standard	BS 1873		BS 1873		BS 1873		BS 1873	
6. Size Range (NPS)	2" - 18"		2" - 18"		2" - 18"		2" - 18"	
7. End Connection	ASME B16.5, RF		ASME B16.5, RF		ASME B16.5, RF		ASME B16.24, RF	
8. Pressure Class	150		150		150		150	
9. Temperature	0°C to 150°C		-46°C to 150°C		-46°C to 400°C		-46°C to 75°C	
10. Material Class	Duplex Steel		Duplex Steel		Stainless Steel		Uncommon Materials	
11. Body Material	ASTM A995 Gr 1b		ASTM A182 Gr F51 or ASTM A995 Gr 4a		ASTM A182 Gr F316 or ASTM A351 Gr CF8M		ASTM B148 (UNS C95800)	
12. TRIM Material	N/A		N/A		N/A		N/A	
13. Obturator Material	Duplex (UNS S32550)		Duplex (UNS S31803)		AISI 316		ASTM B148 (UNS C95800)	
14. Seat Material	Duplex (UNS S32550)		Duplex (UNS S31803)		Stellite (Co-Cr Alloy acc. item A.8.2.1.2)		ASTM B148 (UNS C95800)	
15. Stem Material	ASTM A276 (UNS S32550)		ASTM A276 (UNS S31803)		ASTM A564 Type 630 H1150 (UNS S17400)		ASTM B150 (UNS C63200)	
16. Seat-Stem Seal Material	Flexible graphite with inconel wire		Flexible graphite with inconel wire		Flexible graphite with inconel wire		According manufacturer standard, fitted to service conditions	
17. Operator Type	2" - 6"	Rising Handwheel	2" - 6"	Rising Handwheel	2" - 6"	Rising Handwheel	2" - 6"	Rising Handwheel
	8" - 18"	Gearbox	8" - 18"	Gearbox	8" - 18"	Gearbox	8" - 18"	Gearbox
18. Stem Construction	outside screw stem		outside screw stem		outside screw stem		outside screw stem	
19. Bonnet Construction	bolted bonnet		bolted bonnet		bolted bonnet		bolted bonnet	
20. Product testing	FAT according A.9.3		FAT according A.9.3		FAT according A.9.3		FAT according A.9.3	
21. Coating or Cladding	N/A		N/A		N/A		N/A	
22. Notes	N/A		N/A		N/A		N/A	

Valve Code	VGL-150-2-U302		VGL-225-1-U101		VGL-2500-2-C101		VGL-2500-2-C201	
Specs	B14 B22 B23		B14 B23		H10		H6	
1. Valve Type	Globe		Globe		Globe		Globe	
2. Sealing Type	Metal to Metal		Metal to Metal		Metal to Metal		Metal to Metal	
3. Valve Specification Level (VSL)	VSL-2		VSL-1		VSL-2		VSL-2	
4. Obturator Type	Bevelled Disc		Bevelled Disc		Bevelled Disc		Bevelled Disc	
5. Standard	BS 1873		MSS SP-80		BS 1873		BS 1873	
6. Size Range (NPS)	2" - 18"		½" - 3"		2" - 12"		2" - 14"	
7. End Connection	ASME B16.24, FF		ASME B16.24, FF		ASME B16.5, RTJ		ASME B16.5, RTJ	
8. Pressure Class	150		max. press 225 psig		2500		2500	
9. Temperature	0°C to 75°C		0°C to 75°C		-29°C to 400°C		-46°C to 345°C	
10. Material Class	Uncommon Materials		Uncommon Materials		Carbon Steel		Carbon Steel	
11. Body Material	ASTM B148 (UNS C95800)		ASTM B61 (UNS C92200)		ASTM A105		ASTM A350 Gr LF2 CL1	
12. TRIM Material	N/A		N/A		TRIM CR 13 and HF according BS 1873		N/A	
13. Obturator Material	ASTM B148 (UNS C95800)		ASTM B62 (UNS C83600)		ASTM A182 Gr F6a		ASTM A182 Gr F316	
14. Seat Material	ASTM B148 (UNS C95800)		ASTM B62 (UNS C83600)		Stellite (Co-Cr Alloy acc. item A.8.2.1.2)		Stellite (Co-Cr Alloy acc. item A.8.2.1.2)	
15. Stem Material	ASTM B150 (UNS C63200)		ASTM B62 (UNS C83600)		ASTM A276 (UNS S41000)		ASTM A564 Type 630 H1150 (UNS S17400)	
16. Seat-Stem Seal Material	According manufacturer standard, fitted to service conditions		According manufacturer standard, fitted to service conditions		Flexible graphite with inconel wire		Flexible graphite with inconel wire	
17. Operator Type	2" - 6"	Rising Handwheel	Rising Handwheel		2"	Rising Handwheel	2"	Rising Handwheel
	8" - 18"	Gearbox	N/A		3" - 12"	Gearbox	3" - 14"	Gearbox
18. Stem Construction	outside screw stem		outside screw stem		outside screw stem		outside screw stem	
19. Bonnet Construction	bolted bonnet		union bonnet		bolted bonnet		bolted bonnet	
20. Product testing	FAT according A.9.3		FAT according A.9.3		FAT according A.9.3		FAT according A.9.3	
21. Coating or Cladding	N/A		N/A		N/A		N/A	
22. Notes	N/A		N/A		N/A		N/A	

Valve Code	VGL-2500-2-C501		VGL-2500-2-D201		VGL-2500-2-D301		VGL-2500-2-S201	
Specs	H30P H30		H16		H12		H3	
1. Valve Type	Globe		Globe		Globe		Globe	
2. Sealing Type	Metal to Metal		Metal to Metal		Metal to Metal		Metal to Metal	
3. Valve Specification Level (VSL)	VSL-2		VSL-2		VSL-2		VSL-2	
4. Obturator Type	Bevelled Disc		Bevelled Disc		Bevelled Disc		Bevelled Disc	
5. Standard	BS 1873		BS 1873		BS 1873		BS 1873	
6. Size Range (NPS)	2" - 12"		2" - 12"		2" - 12"		2" - 12"	
7. End Connection	ASME B16.5, RTJ		ASME B16.5, RTJ		ASME B16.5, RTJ		ASME B16.5, RTJ	
8. Pressure Class	2500		2500		2500		2500	
9. Temperature	-29°C to 400°C		-46°C to 150°C		-50°C to 150°C		-46°C to 400°C	
10. Material Class	Carbon Steel		Duplex Steel		Duplex Steel		Stainless Steel	
11. Body Material	ASTM A105 + Inconel 625 weld overlay (acc. item A.7.1.7.3)		ASTM A182 Gr F51		ASTM A182 Gr F55		ASTM A182 Gr F316	
12. TRIM Material	N/A		N/A		N/A		N/A	
13. Obturator Material	ASTM A105 + Inconel 625 weld overlay (acc. item A.7.1.7.3)		ASTM A182 Gr F51		ASTM A182 Gr F55		ASTM A182 Gr F316	
14. Seat Material	ASTM A105 + Inconel 625 weld overlay (acc. item A.7.1.7.3)		ASTM A182 Gr F51		ASTM A182 Gr F55		Stellite (Co-Cr Alloy acc. item A.8.2.1.2)	
15. Stem Material	ASTM B637 (UNS N07718)		ASTM A276 (UNS S31803)		ASTM A276 (UNS S32760)		ASTM A564 Type 630 H1150 (UNS S17400)	
16. Seat-Stem Seal Material	Flexible graphite with inconel wire		Flexible graphite with inconel wire		Flexible graphite with inconel wire		Flexible graphite with inconel wire	
17. Operator Type	2"	Rising Handwheel	2"	Rising Handwheel	2"	Rising Handwheel	2"	Rising Handwheel
	3" - 12"	Gearbox	3" - 12"	Gearbox	3" - 12"	Gearbox	3" - 12"	Gearbox
18. Stem Construction	outside screw stem		outside screw stem		outside screw stem		outside screw stem	
19. Bonnet Construction	bolted bonnet		bolted bonnet		bolted bonnet		bolted bonnet	
20. Product testing	FAT according A.9.3		FAT according A.9.3		FAT according A.9.3		FAT according A.9.3	
21. Coating or Cladding	Full clad - Inconel 625 weld overlay on all wetted parts		N/A		N/A		N/A	
22. Notes	N/A		N/A		N/A		N/A	

Valve Code	VGL-2500-2-S202		VGL-2510-2-C101		VGL-2510-2-C201		VGL-2510-2-C501	
Specs	H3		H10		H6		H30P H30	
1. Valve Type	Globe		Globe		Globe		Globe	
2. Sealing Type	Metal to Metal		Metal to Metal		Metal to Metal		Metal to Metal	
3. Valve Specification Level (VSL)	VSL-2		VSL-2		VSL-2		VSL-2	
4. Obturator Type	Bevelled Disc		Bevelled Disc		Bevelled Disc		Bevelled Disc	
5. Standard	BS 1873		BS 1873		BS 1873		BS 1873	
6. Size Range (NPS)	2" - 12"		2" - 12"		2" - 14"		2" - 12"	
7. End Connection	ASME B16.5, RTJ		ISO 27509, IX		ISO 27509, IX		ISO 27509, IX	
8. Pressure Class	2500		2500		2500		2500	
9. Temperature	-100°C to 400°C		-29°C to 400°C		-46°C to 345°C		-29°C to 400°C	
10. Material Class	Stainless Steel		Carbon Steel		Carbon Steel		Carbon Steel	
11. Body Material	ASTM A182 Gr F316		ASTM A105		ASTM A350 Gr LF2 CL1		ASTM A105 + Inconel 625 weld overlay (acc. item A.7.1.7.3)	
12. TRIM Material	N/A (Low Temperature Stem)		TRIM CR 13 and HF according BS 1873		N/A		N/A	
13. Obturator Material	ASTM A182 Gr F316		ASTM A182 Gr F6a		ASTM A182 Gr F316		ASTM A105 + Inconel 625 weld overlay (acc. item A.7.1.7.3)	
14. Seat Material	Stellite (Co-Cr Alloy acc. item A.8.2.1.2)		Stellite (Co-Cr Alloy acc. item A.8.2.1.2)		Stellite (Co-Cr Alloy acc. item A.8.2.1.2)		ASTM A105 + Inconel 625 weld overlay (acc. item A.7.1.7.3)	
15. Stem Material	ASTM B637 (UNS N07718)		ASTM A276 (UNS S41000)		ASTM A564 Type 630 H1150 (UNS S17400)		ASTM B637 (UNS N07718)	
16. Seat-Stem Seal Material	Flexible graphite with inconel wire		Flexible graphite with inconel wire		Flexible graphite with inconel wire		Flexible graphite with inconel wire	
17. Operator Type	2"	Rising Handwheel	2"	Rising Handwheel	2"	Rising Handwheel	2"	Rising Handwheel
	3" - 12"	Gearbox	3" - 12"	Gearbox	3" - 14"	Gearbox	3" - 12"	Gearbox
18. Stem Construction	outside screw stem		outside screw stem		outside screw stem		outside screw stem	
19. Bonnet Construction	bolted bonnet		bolted bonnet		bolted bonnet		bolted bonnet	
20. Product testing	FAT according A.9.3		FAT according A.9.3		FAT according A.9.3		FAT according A.9.3	
21. Coating or Cladding	N/A		N/A		N/A		Full clad - Inconel 625 weld overlay on all wetted parts	
22. Notes	N/A		N/A		N/A		N/A	

Valve Code	VGL-2510-2-D201		VGL-2510-2-D301		VGL-2510-2-S201		VGL-2510-2-S202	
Specs	H16		H12		H3		H3	
1. Valve Type	Globe		Globe		Globe		Globe	
2. Sealing Type	Metal to Metal		Metal to Metal		Metal to Metal		Metal to Metal	
3. Valve Specification Level (VSL)	VSL-2		VSL-2		VSL-2		VSL-2	
4. Obturator Type	Bevelled Disc		Bevelled Disc		Bevelled Disc		Bevelled Disc	
5. Standard	BS 1873		BS 1873		BS 1873		BS 1873	
6. Size Range (NPS)	2" - 12"		2" - 12"		2" - 12"		2" - 12"	
7. End Connection	ISO 27509, IX		ISO 27509, IX		ISO 27509, IX		ISO 27509, IX	
8. Pressure Class	2500		2500		2500		2500	
9. Temperature	-46°C to 150°C		-50°C to 150°C		-46°C to 400°C		-100°C to 400°C	
10. Material Class	Duplex Steel		Duplex Steel		Stainless Steel		Stainless Steel	
11. Body Material	ASTM A182 Gr F51		ASTM A182 Gr F55		ASTM A182 Gr F316		ASTM A182 Gr F316	
12. TRIM Material	N/A		N/A		N/A		N/A (Low Temperature Stem)	
13. Obturator Material	ASTM A182 Gr F51		ASTM A182 Gr F55		ASTM A182 Gr F316		ASTM A182 Gr F316	
14. Seat Material	ASTM A182 Gr F51		ASTM A182 Gr F55		Stellite (Co-Cr Alloy acc. item A.8.2.1.2)		Stellite (Co-Cr Alloy acc. item A.8.2.1.2)	
15. Stem Material	ASTM A276 (UNS S31803)		ASTM A276 (UNS S32760)		ASTM A564 Type 630 H1150 (UNS S17400)		ASTM B637 (UNS N07718)	
16. Seat-Stem Seal Material	Flexible graphite with inconel wire		Flexible graphite with inconel wire		Flexible graphite with inconel wire		Flexible graphite with inconel wire	
17. Operator Type	2"	Rising Handwheel	2"	Rising Handwheel	2"	Rising Handwheel	2"	Rising Handwheel
	3" - 12"	Gearbox	3" - 12"	Gearbox	3" - 12"	Gearbox	3" - 12"	Gearbox
18. Stem Construction	outside screw stem		outside screw stem		outside screw stem		outside screw stem	
19. Bonnet Construction	bolted bonnet		bolted bonnet		bolted bonnet		bolted bonnet	
20. Product testing	FAT according A.9.3		FAT according A.9.3		FAT according A.9.3		FAT according A.9.3	
21. Coating or Cladding	N/A		N/A		N/A		N/A	
22. Notes	N/A		N/A		N/A		N/A	

Valve Code	VGL-300-1-C101		VGL-300-1-C102		VGL-300-1-C201		VGL-300-1-D201	
Specs	C9 C10 R9C S9C		C4		C6 C19		C11 C16	
1. Valve Type	Globe		Globe		Globe		Globe	
2. Sealing Type	Metal to Metal		Metal to Metal		Metal to Metal		Metal to Metal	
3. Valve Specification Level (VSL)	VSL-1		VSL-1		VSL-1		VSL-1	
4. Obturator Type	Bevelled Disc		Bevelled Disc		Bevelled Disc		Bevelled Disc	
5. Standard	BS 1873		BS 1873		BS 1873		BS 1873	
6. Size Range (NPS)	2" - 18"		2" - 18"		2" - 18"		2" - 18"	
7. End Connection	ASME B16.5, RF		ASME B16.5, RF		ASME B16.5, RF		ASME B16.5, RF	
8. Pressure Class	300		300		300		300	
9. Temperature	-29°C to 400°C		-29°C to 400°C		-46°C to 345°C		-46°C to 150°C	
10. Material Class	Carbon Steel		Carbon Steel		Carbon Steel		Duplex Steel	
11. Body Material	ASTM A105 or ASTM A216 Gr WCB		ASTM A105 or ASTM A216 Gr WCB		ASTM A350 Gr LF2 CL1 or ASTM A352 Gr LCB		ASTM A182 Gr F51 or ASTM A995 Gr 4a	
12. TRIM Material	TRIM CR 13 and HF according BS 1873		TRIM HF according BS 1873		N/A		N/A	
13. Obturator Material	AISI 410		Stellite (Co-Cr Alloy acc. item A.8.2.1.2)		AISI 316		Duplex (UNS S31803)	
14. Seat Material	Stellite (Co-Cr Alloy acc. item A.8.2.1.2)		Stellite (Co-Cr Alloy acc. item A.8.2.1.2)		Stellite (Co-Cr Alloy acc. item A.8.2.1.2)		Duplex (UNS S31803)	
15. Stem Material	ASTM A276 (UNS S41000)		ASTM A276 (UNS S41000)		ASTM A564 Type 630 H1150 (UNS S17400)		ASTM A276 (UNS S31803)	
16. Seat-Stem Seal Material	Flexible graphite with inconel wire		Flexible graphite with inconel wire		Flexible graphite with inconel wire		Flexible graphite with inconel wire	
17. Operator Type	2" - 6"	Rising Handwheel	2" - 6"	Rising Handwheel	2" - 6"	Rising Handwheel	2" - 6"	Rising Handwheel
	8" - 18"	Gearbox	8" - 18"	Gearbox	8" - 18"	Gearbox	8" - 18"	Gearbox
18. Stem Construction	outside screw stem		outside screw stem		outside screw stem		outside screw stem	
19. Bonnet Construction	bolted bonnet		bolted bonnet		bolted bonnet		bolted bonnet	
20. Product testing	FAT according A.9.3		FAT according A.9.3		FAT according A.9.3		FAT according A.9.3	
21. Coating or Cladding	N/A		N/A		N/A		N/A	
22. Notes	N/A		N/A		N/A		N/A	

Valve Code	VGL-300-1-S201		VGL-300-1-U301		VGL-300-2-C101		VGL-300-2-C102	
Specs	C3 R3C S3C		C23		C9 C10		C4 S9C	
1. Valve Type	Globe		Globe		Globe		Globe	
2. Sealing Type	Metal to Metal		Metal to Metal		Metal to Metal		Metal to Metal	
3. Valve Specification Level (VSL)	VSL-1		VSL-1		VSL-2		VSL-2	
4. Obturator Type	Bevelled Disc		Bevelled Disc		Bevelled Disc		Bevelled Disc	
5. Standard	BS 1873		BS 1873		BS 1873		BS 1873	
6. Size Range (NPS)	2" - 18"		2" - 12"		2" - 18"		2" - 18"	
7. End Connection	ASME B16.5, RF		ASME B16.5, RF		ASME B16.5, RF		ASME B16.5, RF	
8. Pressure Class	300		300		300		300	
9. Temperature	-29°C to 400°C		-46°C to 75°C		-29°C to 400°C		-29°C to 400°C	
10. Material Class	Stainless Steel		Uncommon Materials		Carbon Steel		Carbon Steel	
11. Body Material	ASTM A182 Gr F316 or ASTM A351 Gr CF8M		ASTM B148 (UNS C95800)		ASTM A105 or ASTM A216 Gr WCB		ASTM A105 or ASTM A216 Gr WCB	
12. TRIM Material	N/A		N/A		TRIM CR 13 and HF according BS 1873		TRIM HF according BS 1873	
13. Obturator Material	AISI 316		ASTM B148 (UNS C95800)		AISI 410		Stellite (Co-Cr Alloy acc. item A.8.2.1.2)	
14. Seat Material	Stellite (Co-Cr Alloy acc. item A.8.2.1.2)		ASTM B148 (UNS C95800)		Stellite (Co-Cr Alloy acc. item A.8.2.1.2)		Stellite (Co-Cr Alloy acc. item A.8.2.1.2)	
15. Stem Material	ASTM A276 (UNS S41000)		ASTM B150 (UNS C63200)		ASTM A276 (UNS S41000)		ASTM A276 (UNS S41000)	
16. Seat-Stem Seal Material	Flexible graphite with inconel wire		According manufacturer standard, fitted to service conditions		Flexible graphite with inconel wire		Flexible graphite with inconel wire	
17. Operator Type	2" - 6"	Rising Handwheel	2" - 6"	Rising Handwheel	2" - 6"	Rising Handwheel	2" - 6"	Rising Handwheel
	8" - 18"	Gearbox	8" - 12"	Gearbox	8" - 18"	Gearbox	8" - 18"	Gearbox
18. Stem Construction	outside screw stem		outside screw stem		outside screw stem		outside screw stem	
19. Bonnet Construction	bolted bonnet		bolted bonnet		bolted bonnet		bolted bonnet	
20. Product testing	FAT according A.9.3		FAT according A.9.3		FAT according A.9.3		FAT according A.9.3	
21. Coating or Cladding	N/A		N/A		N/A		N/A	
22. Notes	N/A		N/A		N/A		N/A	

Valve Code	VGL-300-2-C201		VGL-300-2-C501		VGL-300-2-D101		VGL-300-2-D201	
Specs	C6 C19		C30		C11		C11 C16	
1. Valve Type	Globe		Globe		Globe		Globe	
2. Sealing Type	Metal to Metal		Metal to Metal		Metal to Metal		Metal to Metal	
3. Valve Specification Level (VSL)	VSL-2		VSL-2		VSL-2		VSL-2	
4. Obturator Type	Bevelled Disc		Bevelled Disc		Bevelled Disc		Bevelled Disc	
5. Standard	BS 1873		BS 1873		BS 1873		BS 1873	
6. Size Range (NPS)	2" - 18"		2" - 20"		2" - 16"		2" - 18"	
7. End Connection	ASME B16.5, RF		ASME B16.5, RF		ASME B16.5, RF		ASME B16.5, RF	
8. Pressure Class	300		300		300		300	
9. Temperature	-46°C to 345°C		-29°C to 400°C		0°C to 150°C		-46°C to 150°C	
10. Material Class	Carbon Steel		Carbon Steel		Duplex Steel		Duplex Steel	
11. Body Material	ASTM A350 Gr LF2 CL1 or ASTM A352 Gr LCB		ASTM A105 or ASTM A216 Gr WCB + Inconel 625 weld overlay (acc. item A.7.1.7.3)		ASTM A995 Gr 1b		ASTM A182 Gr F51 or ASTM A995 Gr 4a	
12. TRIM Material	N/A		N/A		N/A		N/A	
13. Obturator Material	AISI 316		ASTM A105 + Inconel 625 weld overlay (acc. item A.7.1.7.3)		Duplex (UNS S32550)		Duplex (UNS S31803)	
14. Seat Material	Stellite (Co-Cr Alloy acc. item A.8.2.1.2)		ASTM A105 + Inconel 625 weld overlay (acc. item A.7.1.7.3)		Duplex (UNS S32550)		Duplex (UNS S31803)	
15. Stem Material	ASTM A564 Type 630 H1150 (UNS S17400)		ASTM B637 (UNS N07718)		ASTM A276 (UNS S32550)		ASTM A276 (UNS S31803)	
16. Seat-Stem Seal Material	Flexible graphite with inconel wire		Flexible graphite with inconel wire		Flexible graphite with inconel wire		Flexible graphite with inconel wire	
17. Operator Type	2" - 6"	Rising Handwheel	2" - 6"	Rising Handwheel	2" - 6"	Rising Handwheel	2" - 6"	Rising Handwheel
	8" - 18"	Gearbox	8" - 20"	Gearbox	8" - 16"	Gearbox	8" - 18"	Gearbox
18. Stem Construction	outside screw stem		outside screw stem		outside screw stem		outside screw stem	
19. Bonnet Construction	bolted bonnet		bolted bonnet		bolted bonnet		bolted bonnet	
20. Product testing	FAT according A.9.3		FAT according A.9.3		FAT according A.9.3		FAT according A.9.3	
21. Coating or Cladding	N/A		Full clad - Inconel 625 weld overlay on all wetted parts		N/A		N/A	
22. Notes	N/A		N/A		N/A		N/A	

Valve Code	VGL-300-2-D301		VGL-300-2-S201		VGL-600-1-C101		VGL-600-1-C201	
Specs	C12		C3		E9 E10		E6 E19	
1. Valve Type	Globe		Globe		Globe		Globe	
2. Sealing Type	Metal to Metal		Metal to Metal		Metal to Metal		Metal to Metal	
3. Valve Specification Level (VSL)	VSL-2		VSL-2		VSL-1		VSL-1	
4. Obturator Type	Bevelled Disc		Bevelled Disc		Bevelled Disc		Bevelled Disc	
5. Standard	BS 1873		BS 1873		BS 1873		BS 1873	
6. Size Range (NPS)	2" - 18"		2" - 18"		2" - 4"		2" - 4"	
7. End Connection	ASME B16.5, RF		ASME B16.5, RF		ASME B16.5, RF		ASME B16.5, RF	
8. Pressure Class	300		300		600		600	
9. Temperature	-46°C to 150°C		-46°C to 400°C		-29°C to 400°C		-46°C to 345°C	
10. Material Class	Duplex Steel		Stainless Steel		Carbon Steel		Carbon Steel	
11. Body Material	ASTM A182 Gr F55 or ASTM A995 Gr 6a		ASTM A182 Gr F316 or ASTM A351 Gr CF8M		ASTM A105 or ASTM A216 Gr WCB		ASTM A350 Gr LF2 CL1 or ASTM A352 Gr LCB	
12. TRIM Material	N/A		N/A		TRIM CR 13 and HF according BS 1873		N/A	
13. Obturator Material	Super Duplex (UNS S32760)		AISI 316		AISI 410		AISI 316	
14. Seat Material	Super Duplex (UNS S32760)		Stellite (Co-Cr Alloy acc. item A.8.2.1.2)		Stellite (Co-Cr Alloy acc. item A.8.2.1.2)		Stellite (Co-Cr Alloy acc. item A.8.2.1.2)	
15. Stem Material	ASTM A276 (UNS S32760)		ASTM A564 Type 630 H1150 (UNS S17400)		ASTM A276 (UNS S41000)		ASTM A564 Type 630 H1150 (UNS S17400)	
16. Seat-Stem Seal Material	Flexible graphite with inconel wire		Flexible graphite with inconel wire		Flexible graphite with inconel wire		Flexible graphite with inconel wire	
17. Operator Type	2" - 6"	Rising Handwheel	2" - 6"	Rising Handwheel	2" - 3"	Rising Handwheel	2" - 3"	Rising Handwheel
	8" - 18"	Gearbox	8" - 18"	Gearbox	4"	Gearbox	4"	Gearbox
18. Stem Construction	outside screw stem		outside screw stem		outside screw stem		outside screw stem	
19. Bonnet Construction	bolted bonnet		bolted bonnet		bolted bonnet		bolted bonnet	
20. Product testing	FAT according A.9.3		FAT according A.9.3		FAT according A.9.3		FAT according A.9.3	
21. Coating or Cladding	N/A		N/A		N/A		N/A	
22. Notes	N/A		N/A		N/A		N/A	

Valve Code	VGL-600-1-D201		VGL-600-1-S201		VGL-600-2-A501		VGL-600-2-C101	
Specs	E16		E3		E32		E9 E10	
1. Valve Type	Globe		Globe		Globe		Globe	
2. Sealing Type	Metal to Metal		Metal to Metal		Metal to Metal		Metal to Metal	
3. Valve Specification Level (VSL)	VSL-1		VSL-1		VSL-2		VSL-2	
4. Obturator Type	Bevelled Disc		Bevelled Disc		Bevelled Disc		Bevelled Disc	
5. Standard	BS 1873		BS 1873		BS 1873		BS 1873	
6. Size Range (NPS)	2" - 4"		2" - 4"		2" - 14"		2" - 12"	
7. End Connection	ASME B16.5, RF		ASME B16.5, RF		ASME B16.5, RF		ASME B16.5, RF	
8. Pressure Class	600		600		600		600	
9. Temperature	-46°C to 150°C		-29°C to 400°C		-100°C to 345°C		-29°C to 400°C	
10. Material Class	Duplex Steel		Stainless Steel		Alloy Steel		Carbon Steel	
11. Body Material	ASTM A182 Gr F51 or ASTM A995 Gr 4a		ASTM A182 Gr F316 or ASTM A351 Gr CF8M		ASTM A350 Gr LF3 or ASTM A352 Gr LC3 + Inconel 625 weld overlay (acc. item A.7.1.7.3)		ASTM A105 or ASTM A216 Gr WCB	
12. TRIM Material	N/A		N/A		N/A		TRIM CR 13 and HF according BS 1873	
13. Obturator Material	Duplex (UNS S31803)		AISI 316		ASTM A350 Gr LF3 + Inconel 625 weld overlay (acc. item A.7.1.7.3)		AISI 410	
14. Seat Material	Duplex (UNS S31803)		Stellite (Co-Cr Alloy acc. item A.8.2.1.2)		ASTM A350 Gr LF3 + Inconel 625 weld overlay (acc. item A.7.1.7.3)		Stellite (Co-Cr Alloy acc. item A.8.2.1.2)	
15. Stem Material	ASTM A276 (UNS S31803)		ASTM A276 (UNS S41000)		ASTM B637 (UNS N07718)		ASTM A276 (UNS S41000)	
16. Seat-Stem Seal Material	Flexible graphite with inconel wire		Flexible graphite with inconel wire		Flexible graphite with inconel wire		Flexible graphite with inconel wire	
17. Operator Type	2" - 3"	Rising Handwheel	2" - 3"	Rising Handwheel	2" - 3"	Rising Handwheel	2" - 3"	Rising Handwheel
	4"	Gearbox	4"	Gearbox	4" - 14"	Gearbox	4" - 12"	Gearbox
18. Stem Construction	outside screw stem		outside screw stem		outside screw stem		outside screw stem	
19. Bonnet Construction	bolted bonnet		bolted bonnet		bolted bonnet		bolted bonnet	
20. Product testing	FAT according A.9.3		FAT according A.9.3		FAT according A.9.3		FAT according A.9.3	
21. Coating or Cladding	N/A		N/A		Full clad - Inconel 625 weld overlay on all wetted parts		N/A	
22. Notes	N/A		N/A		N/A		N/A	

Valve Code	VGL-600-2-C201		VGL-600-2-C501		VGL-600-2-D201		VGL-600-2-S201	
Specs	E6 E19		E30		E16		E3	
1. Valve Type	Globe		Globe		Globe		Globe	
2. Sealing Type	Metal to Metal		Metal to Metal		Metal to Metal		Metal to Metal	
3. Valve Specification Level (VSL)	VSL-2		VSL-2		VSL-2		VSL-2	
4. Obturator Type	Bevelled Disc		Bevelled Disc		Bevelled Disc		Bevelled Disc	
5. Standard	BS 1873		BS 1873		BS 1873		BS 1873	
6. Size Range (NPS)	2" - 14"		2" - 12"		2" - 12"		2" - 16"	
7. End Connection	ASME B16.5, RF		ASME B16.5, RF		ASME B16.5, RF		ASME B16.5, RF	
8. Pressure Class	600		600		600		600	
9. Temperature	-46°C to 345°C		-29°C to 400°C		-46°C to 150°C		-46°C to 400°C	
10. Material Class	Carbon Steel		Carbon Steel		Duplex Steel		Stainless Steel	
11. Body Material	ASTM A350 Gr LF2 CL1 or ASTM A352 Gr LCB		ASTM A105 or ASTM A216 Gr WCB + Inconel 625 weld overlay (acc. item A.7.1.7.3)		ASTM A182 Gr F51 or ASTM A995 Gr 4a		ASTM A182 Gr F316 or ASTM A351 Gr CF8M	
12. TRIM Material	N/A		N/A		N/A		N/A	
13. Obturator Material	AISI 316		ASTM A105 + Inconel 625 weld overlay (acc. item A.7.1.7.3)		Duplex (UNS S31803)		AISI 316	
14. Seat Material	Stellite (Co-Cr Alloy acc. item A.8.2.1.2)		ASTM A105 + Inconel 625 weld overlay (acc. item A.7.1.7.3)		Duplex (UNS S31803)		Stellite (Co-Cr Alloy acc. item A.8.2.1.2)	
15. Stem Material	ASTM A564 Type 630 H1150 (UNS S17400)		ASTM B637 (UNS N07718)		ASTM A276 (UNS S31803)		ASTM A564 Type 630 H1150 (UNS S17400)	
16. Seat-Stem Seal Material	Flexible graphite with inconel wire		Flexible graphite with inconel wire		Flexible graphite with inconel wire		Flexible graphite with inconel wire	
17. Operator Type	2" - 3"	Rising Handwheel	2" - 3"	Rising Handwheel	2" - 3"	Rising Handwheel	2" - 3"	Rising Handwheel
	4" - 14"	Gearbox	4" - 12"	Gearbox	4" - 12"	Gearbox	4" - 16"	Gearbox
18. Stem Construction	outside screw stem		outside screw stem		outside screw stem		outside screw stem	
19. Bonnet Construction	bolted bonnet		bolted bonnet		bolted bonnet		bolted bonnet	
20. Product testing	FAT according A.9.3		FAT according A.9.3		FAT according A.9.3		FAT according A.9.3	
21. Coating or Cladding	N/A		Full clad - Inconel 625 weld overlay on all wetted parts		N/A		N/A	
22. Notes	N/A		N/A		N/A		N/A	

Valve Code	VGL-900-1-C101		VGL-900-1-S201		VGL-900-2-C101		VGL-900-2-C201	
Specs	F10		F3		F10		F6	
1. Valve Type	Globe		Globe		Globe		Globe	
2. Sealing Type	Metal to Metal		Metal to Metal		Metal to Metal		Metal to Metal	
3. Valve Specification Level (VSL)	VSL-1		VSL-1		VSL-2		VSL-2	
4. Obturator Type	Bevelled Disc		Bevelled Disc		Bevelled Disc		Bevelled Disc	
5. Standard	BS 1873		BS 1873		BS 1873		BS 1873	
6. Size Range (NPS)	2" - 4"		2" - 4"		2" - 14"		2" - 14"	
7. End Connection	ASME B16.5, RTJ		ASME B16.5, RTJ		ASME B16.5, RTJ		ASME B16.5, RTJ	
8. Pressure Class	900		900		900		900	
9. Temperature	-29°C to 400°C		-29°C to 400°C		-29°C to 400°C		-46°C to 345°C	
10. Material Class	Carbon Steel		Stainless Steel		Carbon Steel		Carbon Steel	
11. Body Material	ASTM A105 or ASTM A216 Gr WCB		ASTM A182 Gr F316 or ASTM A351 Gr CF8M		ASTM A105 or ASTM A216 Gr WCB		ASTM A350 Gr LF2 CL1 or ASTM A352 Gr LCB	
12. TRIM Material	TRIM CR 13 and HF according BS 1873		N/A		TRIM CR 13 and HF according BS 1873		N/A	
13. Obturator Material	AISI 410		AISI 316		AISI 410		AISI 316	
14. Seat Material	Stellite (Co-Cr Alloy acc. item A.8.2.1.2)		Stellite (Co-Cr Alloy acc. item A.8.2.1.2)		Stellite (Co-Cr Alloy acc. item A.8.2.1.2)		Stellite (Co-Cr Alloy acc. item A.8.2.1.2)	
15. Stem Material	ASTM A276 (UNS S41000)		ASTM A276 (UNS S41000)		ASTM A276 (UNS S41000)		ASTM A564 Type 630 H1150 (UNS S17400)	
16. Seat-Stem Seal Material	Flexible graphite with inconel wire		Flexible graphite with inconel wire		Flexible graphite with inconel wire		Flexible graphite with inconel wire	
17. Operator Type	2" - 3"	Rising Handwheel	2" - 3"	Rising Handwheel	2" - 3"	Rising Handwheel	2" - 3"	Rising Handwheel
	4"	Gearbox	4"	Gearbox	4" - 14"	Gearbox	4" - 14"	Gearbox
18. Stem Construction	outside screw stem		outside screw stem		outside screw stem		outside screw stem	
19. Bonnet Construction	bolted bonnet		bolted bonnet		bolted bonnet		bolted bonnet	
20. Product testing	FAT according A.9.3		FAT according A.9.3		FAT according A.9.3		FAT according A.9.3	
21. Coating or Cladding	N/A		N/A		N/A		N/A	
22. Notes	N/A		N/A		N/A		N/A	

Valve Code	VGL-900-2-S201	
Specs	F3	
1. Valve Type	Globe	
2. Sealing Type	Metal to Metal	
3. Valve Specification Level (VSL)	VSL-2	
4. Obturator Type	Bevelled Disc	
5. Standard	BS 1873	
6. Size Range (NPS)	2" - 14"	
7. End Connection	ASME B16.5, RTJ	
8. Pressure Class	900	
9. Temperature	-100°C to 400°C	
10. Material Class	Stainless Steel	
11. Body Material	ASTM A182 Gr F316 or ASTM A351 Gr CF8M	
12. TRIM Material	N/A	
13. Obturator Material	AISI 316	
14. Seat Material	Stellite (Co-Cr Alloy acc. item A.8.2.1.2)	
15. Stem Material	ASTM B637 (UNS N07718)	
16. Seat-Stem Seal Material	Flexible graphite with inconel wire	
17. Operator Type	2" - 3"	Rising Handwheel
	4" - 14"	Gearbox
18. Stem Construction	outside screw stem	
19. Bonnet Construction	bolted bonnet	
20. Product testing	FAT according A.9.3	
21. Coating or Cladding	N/A	
22. Notes	N/A	

A.12.7 CHECK VALVES

Valve Code	VRE-10000-2-D325		VRE-10000-2-D335		VRE-10000-2-N125		VRE-1500-1-C102
Specs	J12P J12		J12		J40P J40		F10 G10P
1. Valve Type	Check		Check		Check		Check
2. Sealing Type	Metal to Metal		Metal to Metal		Metal to Metal		Metal to Metal
3. Valve Specification Level (VSL)	VSL-2		VSL-2		VSL-2		VSL-1
4. Obturator Type	Swing		Axial non-slam		Swing		Piston
5. Standard	API 6A		API 6A		API 6A		API 602
6. Size Range (NPS)	1" - 2"	1 13/16"	1" - 2"	1 13/16"	1" - 2"	1 13/16"	N/A
	3"	2 1/16"	3"	2 1/16"	3"	2 1/16"	N/A
	4"	2 9/16"	4"	2 9/16"	4"	2 9/16"	N/A
	6"	4 1/16"	6"	4 1/16"	6"	4 1/16"	N/A
	8"	5 1/8"	8"	5 1/8"	8"	5 1/8"	N/A
	10"	7 1/16"	10"	7 1/16"	10"	7 1/16"	N/A
	12" - 14"	9"	12" - 14"	9"	12" - 14"	9"	N/A
7. End Connection	API 6A, studded type 6BX (stud and nuts included)		API 6A, studded type 6BX (stud and nuts included)		API 6A, studded type 6BX (stud and nuts included)		N/A
8. Pressure Class	max. press 10000 psi		max. press 10000 psi		max. press 10000 psi		1500
9. Temperature	-50°C to 120°C		-50°C to 120°C		-100°C to 200°C		-29°C to 400°C
10. Material Class	Duplex Steel		Duplex Steel		Nickel Alloys		Carbon Steel
11. Body Material	ASTM A182 Gr F55		ASTM A182 Gr F55		ASTM B564 (UNS N06625)		ASTM A105
12. TRIM Material	N/A		N/A		N/A		N/A
13. Obturator Material	Super Duplex (UNS S32760)		Super Duplex (UNS S32760)		ASTM B564 (UNS N06625)		AISI 410
14. Seat Material	Super Duplex (UNS S32760)		Super Duplex (UNS S32760)		ASTM B564 (UNS N06625)		Stellite (Co-Cr Alloy acc. item A.8.2.1.2)
15. Spring Material	UNS N07750		UNS N07750		UNS N07750		N/A
16. Shaft Material	ASTM A276 (UNS S32760)		ASTM A276 (UNS S32760)		ASTM B637 (UNS N07718)		Not Applicable
17. Additional Requirement	N/A		Fire safe design (acc. item A.6.1.5)		N/A		Fire safe design (acc. item A.6.1.5)
18. Cover Construction	bolted cover		bolted cover		bolted cover		bolted cover
19. Product testing	FAT according A.9.3		FAT according A.9.3		FAT according A.9.3		FAT according A.9.3
20. Cladding or Coating	N/A		N/A		N/A		N/A
21. Notes	N/A		N/A		N/A		N/A

Valve Code	VRE-1500-1-C202	VRE-1500-1-S202	VRE-1500-2-S202	VRE-1500-2-S212
Specs	F6	F3 G3	F3 G3	G3
1. Valve Type	Check	Check	Check	Check
2. Sealing Type	Metal to Metal	Metal to Metal	Metal to Metal	Metal to Metal
3. Valve Specification Level (VSL)	VSL-1	VSL-1	VSL-2	VSL-2
4. Obturator Type	Piston	Piston	Piston	Dual Plate
5. Standard	API 602	API 602	API 602	API 594
6. Size Range (NPS)	½" - 1 ½"	½" - 1 ½"	½" - 1 ½"	2" - 16"
7. End Connection	socket weld ends ASME B16.11	socket weld ends ASME B16.11	socket weld ends ASME B16.11	N/A
8. Pressure Class	1500	1500	1500	1500
9. Temperature	-46°C to 345°C	-100°C to 400°C	-100°C to 400°C	-100°C to 400°C
10. Material Class	Carbon Steel	Stainless Steel	Stainless Steel	Stainless Steel
11. Body Material	ASTM A350 Gr LF2 CL1	ASTM A182 Gr F316/316L	ASTM A182 Gr F316/316L	ASTM A182 Gr F316
12. TRIM Material	N/A	N/A	N/A	TRIM 12 according API 594
13. Obturator Material	AISI 316	AISI 316L	AISI 316L	AISI 316
14. Seat Material	Stellite (Co-Cr Alloy acc. item A.8.2.1.2)	Stellite (Co-Cr Alloy acc. item A.8.2.1.2)	Stellite (Co-Cr Alloy acc. item A.8.2.1.2)	Stellite (Co-Cr Alloy acc. item A.8.2.1.2)
15. Spring Material	N/A	N/A	N/A	UNS N07750
16. Shaft Material	Not Applicable	Not Applicable	Not Applicable	ASTM A276 (UNS S31600)
17. Operator Type	N/A	N/A	N/A	N/A
18. Additional Requirement	Fire safe design (acc. item A.6.1.5)	Fire safe design (acc. item A.6.1.5)	Fire safe design (acc. item A.6.1.5)	Fire safe design (acc. item A.6.1.5)
19. Cover Construction	bolted cover	bolted cover	bolted cover	bolted cover
20. Product testing	FAT according A.9.3	FAT according A.9.3	FAT according A.9.3	FAT according A.9.3
21. Notes	N/A	N/A	N/A	Wafer valves shall not to be used with flammable services

Valve Code	VRE-1500-2-S215	VRE-1500-2-S235	VRE-150-1-C111		VRE-150-1-C113
Specs	G3	G3	B9 B10 R9B S9B		B4
1. Valve Type	Check, Flanged type	Check, Flanged type	Check, Wafer type		Check, Wafer type
2. Sealing Type	Metal to Metal	Metal to Metal	Soft		Metal to Metal
3. Valve Specification Level (VSL)	VSL-2	VSL-2	VSL-1		VSL-1
4. Obturator Type	Dual Plate	Axial non-slam	Dual Plate		Dual Plate
5. Standard	API 594	API 6D	API 594		API 594
6. Size Range (NPS)	2" - 16"	2" - 16"	2" - 36"		2" - 24"
7. End Connection	ASME B16.5, RTJ	ASME B16.5, RTJ	2" - 24"	ASME B16.5	ASME B16.5
	N/A	N/A	26" - 36"	ASME B16.47 Series A	N/A
8. Pressure Class	1500	1500	150		150
9. Temperature	-100°C to 400°C	-100°C to 210°C	0°C to 150°C		-29°C to 400°C
10. Material Class	Stainless Steel	Stainless Steel	Carbon Steel		Carbon Steel
11. Body Material	ASTM A182 Gr F316	ASTM A182 Gr F316	ASTM A105 or ASTM A216 Gr WCB		ASTM A105 or ASTM A216 Gr WCB
12. TRIM Material	TRIM 12 according API 594	N/A	TRIM 1 according API 594		TRIM 5 according API 594
13. Obturator Material	AISI 316	AISI 316	AISI 410		Stellite (Co-Cr Alloy acc. item A.8.2.1.2)
14. Seat Material	Stellite (Co-Cr Alloy acc. item A.8.2.1.2)	AISI 316	Group A (acc. item A.7.3.3.1)		Stellite (Co-Cr Alloy acc. item A.8.2.1.2)
15. Spring Material	UNS N07750	UNS N07750	UNS N07750		UNS N07750
16. Shaft Material	ASTM A276 (UNS S31600)	Not Applicable	ASTM A276 (UNS S41000)		ASTM A276 (UNS S41000)
17. Additional Requirement	Fire safe design (acc. item A.6.1.5)	Fire safe design (acc. item A.6.1.5)	N/A		Fire safe design (acc. item A.6.1.5)
18. Cover Construction	bolted cover	bolted cover	bolted cover		bolted cover
19. Product testing	FAT according A.9.3	FAT according A.9.3	FAT according A.9.3		FAT according A.9.3
20. Cladding or Coating	N/A	N/A	N/A		N/A
21. Notes	N/A	N/A	Wafer valves shall not to be used with flammable services		Wafer valves shall not to be used with flammable services

Valve Code	VRE-150-1-C211		VRE-150-1-D111		VRE-150-1-D114		VRE-150-1-D205	
Specs	B6 B19		B26		B11 B26		B11	
1. Valve Type	Check, Wafer type		Check, Wafer type		Check, Wafer type		Check, Flanged type	
2. Sealing Type	Soft		Soft		Soft		Metal to Metal	
3. Valve Specification Level (VSL)	VSL-1		VSL-1		VSL-1		VSL-1	
4. Obturator Type	Dual Plate		Dual Plate		Dual Plate		Piston	
5. Standard	API 594		API 594		API 594		API 602	
6. Size Range (NPS)	2" - 36"		2" - 24"		2" - 28"		1" - 1 1/2"	
7. End Connection	2" - 24"	ASME B16.5, RF	ASME B16.5, FF		2" - 24"	ASME B16.5, RF	N/A	
	26" - 36"	ASME B16.47 Series A, RF	N/A		26" - 28"	ASME B16.47 Series A, RF	N/A	
8. Pressure Class	150		150		150		150	
9. Temperature	0°C to 345°C		0°C to 150°C		0°C to 150°C		-46°C to 150°C	
10. Material Class	Carbon Steel		Duplex Steel		Duplex Steel		Duplex Steel	
11. Body Material	ASTM A350 Gr LF2 CL1 or ASTM A352 Gr LCB		ASTM A995 Gr 1b		ASTM A995 Gr 1b		ASTM A182 Gr F51	
12. TRIM Material	TRIM 10 according API 594		N/A		N/A		N/A	
13. Obturator Material	AISI 316		Duplex (UNS S32550)		Duplex (UNS S32550)		Duplex (UNS S31803)	
14. Seat Material	Group A (acc. item A.7.3.3.1)		Group A (acc. item A.7.3.3.1)		Group A (acc. item A.7.3.3.1)		Super Duplex (UNS S32760)	
15. Spring Material	UNS N07750		UNS N07750		UNS N07750		N/A	
16. Shaft Material	ASTM A276 (UNS S31600)		ASTM A276 (UNS S31803)		ASTM A276 (UNS S31803)		Not Applicable	
17. Additional Requirement	N/A		N/A		N/A		Fire safe design (acc. item A.6.1.5)	
18. Cover Construction	bolted cover		bolted cover		bolted cover		bolted cover	
19. Product testing	FAT according A.9.3		FAT according A.9.3		FAT according A.9.3		FAT according A.9.3	
20. Cladding or Coating	N/A		N/A		N/A		N/A	
21. Notes	Wafer valves shall not to be used with flammable services		Wafer valves shall not to be used with flammable services		Wafer valves shall not to be used with flammable services		N/A	

Valve Code	VRE-150-1-D211		VRE-150-1-D212		VRE-150-1-D305	VRE-150-1-S211	
Specs	B11 B16		B11		B27	B3 R3B S3B	
1. Valve Type	Check, Wafer type		Check, Wafer type		Check, Flanged type Metal to Metal	Check, Wafer type	
2. Sealing Type	Soft		Metal to Metal		VSL-1	Soft	
3. Valve Specification Level (VSL)	VSL-1		VSL-1		Piston	VSL-1	
4. Obturator Type	Dual Plate		Dual Plate		API 602	Dual Plate	
5. Standard	API 594		API 594		1" - 1 1/2"	API 594	
6. Size Range (NPS)	2" - 32"		2" - 28"		Flange ASME B16.5 (CL150), RF	2" - 36"	
7. End Connection	2" - 24"	ASME B16.5, RF	2" - 24"	ASME B16.5, RF	N/A	2" - 24"	ASME B16.5, RF
	26" - 32"	ASME B16.47 Series A, RF	26" - 28"	ASME B16.47 Series A, RF		26" - 36"	ASME B16.47 Series A, RF
8. Pressure Class	150		150		150	150	
9. Temperature	0°C to 150°C		-46°C to 150°C		-46°C to 150°C	0°C to 150°C	
10. Material Class	Duplex Steel		Duplex Steel		Duplex Steel	Stainless Steel	
11. Body Material	ASTM A182 Gr F51 or ASTM A995 Gr 4a		ASTM A182 Gr F51 or ASTM A995 Gr 4a		ASTM A182 Gr F55	ASTM A182 Gr F316 or ASTM A351 Gr CF8M	
12. TRIM Material	N/A		N/A		N/A	TRIM 10 according API 594	
13. Obturator Material	Duplex (UNS S31803)		Duplex (UNS S31803)		Super Duplex (UNS S32760)	AISI 316	
14. Seat Material	Group A (acc. item A.7.3.3.1)		Duplex (UNS S31803)		Super Duplex (UNS S32760)	Group A (acc. item A.7.3.3.1)	
15. Spring Material	UNS N07750		UNS N07750		N/A	UNS N07750	
16. Shaft Material	ASTM A276 (UNS S31803)		ASTM A276 (UNS S31803)		Not Applicable	ASTM A276 (UNS S31600)	
17. Additional Requirement	N/A		Fire safe design (acc. item A.6.1.5)		Fire safe design (acc. item A.6.1.5)	N/A	
18. Cover Construction	bolted cover		bolted cover		bolted cover	bolted cover	
19. Product testing	FAT according A.9.3		FAT according A.9.3		FAT according A.9.3	FAT according A.9.3	
20. Cladding or Coating	N/A		N/A		N/A	N/A	
21. Notes	Wafer valves shall not to be used with flammable services		Wafer valves shall not to be used with flammable services		N/A	Wafer valves shall not to be used with flammable services	

Valve Code	VRE-150-1-U305	VRE-150-1-U311	VRE-150-1-U312	VRE-150-1-U314
Specs	B14	B7R B7 S7	B7	B14 B22 B23
1. Valve Type	Check	Check	Check	Check
2. Sealing Type	Metal to Metal	Soft	Metal to Metal	Soft
3. Valve Specification Level (VSL)	VSL-1	VSL-1	VSL-1	VSL-1
4. Obturator Type	Piston	Dual Plate	Dual Plate	Dual Plate
5. Standard	API 602	API 594	API 594	API 594
6. Size Range (NPS)	1" - 1 ½"	2" - 36"	2" - 36"	2" - 46"
7. End Connection	ASME B16.42, FF	N/A	N/A	N/A
8. Pressure Class	150	150	150	150
9. Temperature	0°C to 75°C	0°C to 75°C	-46°C to 75°C	0°C to 75°C
10. Material Class	Uncommon Materials	Uncommon Materials	Uncommon Materials	Uncommon Materials
11. Body Material	ASTM B148 (UNS C95800)	ASTM B148 (UNS C95800)	ASTM B148 (UNS C95800)	ASTM B148 (UNS C95800)
12. TRIM Material	N/A	N/A	N/A	N/A
13. Obturator Material	ASTM B148 (UNS C95800)	ASTM B148 (UNS C95800)	ASTM B148 (UNS C95800)	ASTM B148 (UNS C95800)
14. Seat Material	Super Duplex (UNS S32760)	Group A (acc. item A.7.3.3.1)	ASTM B148 (UNS C95800)	Group A (acc. item A.7.3.3.1)
15. Spring Material	N/A	UNS N07750	UNS N07750	UNS N07750
16. Shaft Material	Not Applicable	ASTM B150 (UNS C63200)	ASTM B150 (UNS C63200)	ASTM B150 (UNS C63200)
17. Operator Type	N/A	N/A	N/A	N/A
18. Additional Requirement	Fire safe design (acc. item A.6.1.5)	N/A	N/A	N/A
19. Cover Construction	bolted cover	bolted cover	bolted cover	bolted cover
20. Product testing	FAT according A.9.3	FAT according A.9.3	FAT according A.9.3	FAT according A.9.3
21. Notes	N/A	Wafer valves shall not to be used with flammable services	Wafer valves shall not to be used with flammable services	Wafer valves shall not to be used with flammable services

Valve Code	VRE-150-1-U655	VRE-150-2-C112		VRE-150-2-C113	VRE-150-2-C115	
Specs	B27	B9 B10		B4 59B	B9 B10	
1. Valve Type	Check, Flanged type	Check, Wafer type		Check, Wafer type	Check, Flanged type	
2. Sealing Type	Metal to Metal	Metal to Metal		Metal to Metal	Metal to Metal	
3. Valve Specification Level (VSL)	VSL-1	VSL-2		VSL-2	VSL-2	
4. Obturator Type	Manufacturer Standard	Dual Plate		Dual Plate	Dual Plate	
5. Standard	Manufacturer Standard	API 594		API 594	API 594	
6. Size Range (NPS)	2" - 6"	2" - 36"		2" - 24"	2" - 36"	
7. End Connection	ASME B16.42, FF	2" - 24"	ASME B16.5, RF	ASME B16.5, RF	2" - 24"	ASME B16.5, RF
	N/A	26" - 36"	ASME B16.47 Series A, RF	N/A	26" - 36"	ASME B16.47 Series A, RF
8. Pressure Class	150	150		150	150	
9. Temperature	0°C to 70°C	-29°C to 400°C		-29°C to 400°C	-29°C to 400°C	
10. Material Class	Uncommon Materials	Carbon Steel		Carbon Steel	Carbon Steel	
11. Body Material	ASTM A395 60-40-18 + PFA liner	ASTM A105 or ASTM A216 Gr WCB		ASTM A105 or ASTM A216 Gr WCB	ASTM A105 or ASTM A216 Gr WCB	
12. TRIM Material	N/A	TRIM 8 according API 594		TRIM 5 according API 594	TRIM 8 according API 594	
13. Obturator Material	Stainless Steel + PFA liner	AISI 410		Stellite (Co-Cr Alloy acc. item A.8.2.1.2)	AISI 410	
14. Seat Material	PTFE	Stellite (Co-Cr Alloy acc. item A.8.2.1.2)		Stellite (Co-Cr Alloy acc. item A.8.2.1.2)	Stellite (Co-Cr Alloy acc. item A.8.2.1.2)	
15. Spring Material	According manufacturer standard, fitted to service conditions	UNS N07750		UNS N07750	UNS N07750	
16. Shaft Material	Not Applicable	ASTM A276 (UNS S41000)		ASTM A276 (UNS S41000)	ASTM A276 (UNS S41000)	
17. Additional Requirement	N/A	Fire safe design (acc. item A.6.1.5)		Fire safe design (acc. item A.6.1.5)	Fire safe design (acc. item A.6.1.5)	
18. Cover Construction	bolted cover	bolted cover		bolted cover	bolted cover	
19. Product testing	FAT according manufacturer standard	FAT according A.9.3		FAT according A.9.3	FAT according A.9.3	
20. Cladding or Coating	N/A	N/A		N/A	N/A	
21. Notes	N/A	Wafer valves shall not to be used with flammable services		Wafer valves shall not to be used with flammable services	N/A	

Valve Code	VRE-150-2-C135	VRE-150-2-C212		VRE-150-2-C215		VRE-150-2-C235	
Specs	B10	B6 B19		B6 B19		B6 B19	
1. Valve Type	Check, Flanged type	Check, Wafer type		Check, Flanged type		Check, Flanged type	
2. Sealing Type	Metal to Metal	Metal to Metal		Metal to Metal		Metal to Metal	
3. Valve Specification Level (VSL)	VSL-2	VSL-2		VSL-2		VSL-2	
4. Obturator Type	Axial non-slam	Dual Plate		Dual Plate		Axial non-slam	
5. Standard	API 6D	API 594		API 594		API 6D	
6. Size Range (NPS)	2" - 24"	2" - 36"		2" - 36"		2" - 36"	
7. End Connection	ASME B16.5, RF	2" - 24"	ASME B16.5, RF	2" - 24"	ASME B16.5, RF	2" - 24"	ASME B16.5, RF
	N/A	26" - 36"	ASME B16.47 Series A, RF	26" - 36"	ASME B16.47 Series A, RF	26" - 36"	ASME B16.47 Series A, RF
8. Pressure Class	150	150		150		150	
9. Temperature	-29°C to 210°C	-46°C to 345°C		-46°C to 345°C		-46°C to 210°C	
10. Material Class	Carbon Steel	Carbon Steel		Carbon Steel		Carbon Steel	
11. Body Material	ASTM A105 or ASTM A216 Gr WCB	ASTM A350 Gr LF2 CL1 or ASTM A352 Gr LCB		ASTM A350 Gr LF2 CL1 or ASTM A352 Gr LCB		ASTM A350 Gr LF2 CL1 or ASTM A352 Gr LCB	
12. TRIM Material	N/A	TRIM 12 according API 594		TRIM 12 according API 594		N/A	
13. Obturator Material	AISI 410	AISI 316		AISI 316		AISI 316	
14. Seat Material	AISI 410	Stellite (Co-Cr Alloy acc. item A.8.2.1.2)		Stellite (Co-Cr Alloy acc. item A.8.2.1.2)		AISI 410	
15. Spring Material	UNS N07750	UNS N07750		UNS N07750		UNS N07750	
16. Shaft Material	Not Applicable	ASTM A276 (UNS S31600)		ASTM A276 (UNS S31600)		Not Applicable	
17. Additional Requirement	Fire safe design (acc. item A.6.1.5)	Fire safe design (acc. item A.6.1.5)		Fire safe design (acc. item A.6.1.5)		Fire safe design (acc. item A.6.1.5)	
18. Cover Construction	bolted cover	bolted cover		bolted cover		bolted cover	
19. Product testing	FAT according A.9.3	FAT according A.9.3		FAT according A.9.3		FAT according A.9.3	
20. Cladding or Coating	N/A	N/A		N/A		N/A	
21. Notes	N/A	Wafer valves shall not to be used with flammable services		N/A		N/A	

Valve Code	VRE-150-2-C515		VRE-150-2-C535		VRE-150-2-D212		VRE-150-2-D215	
Specs	B30		B30		B11 B16		B11 B16	
1. Valve Type	Check, Flanged type		Check, Flanged type		Check, Wafer type		Check, Flanged type	
2. Sealing Type	Metal to Metal		Metal to Metal		Metal to Metal		Metal to Metal	
3. Valve Specification Level (VSL)	VSL-2		VSL-2		VSL-2		VSL-2	
4. Obturator Type	Dual Plate		Axial non-slam		Dual Plate		Dual Plate	
5. Standard	API 594		API 6D		API 594		API 594	
6. Size Range (NPS)	2" - 30"		2" - 30"		2" - 32"		2" - 32"	
7. End Connection	2" - 24"	ASME B16.5, RF	2" - 24"	ASME B16.5, RF	2" - 24"	ASME B16.5, RF	2" - 24"	ASME B16.5, RF
	26" - 30"	ASME B16.47 Series A, RF	26" - 30"	ASME B16.47 Series A, RF	26" - 32"	ASME B16.47 Series A, RF	26" - 32"	ASME B16.47 Series A, RF
8. Pressure Class	150		150		150		150	
9. Temperature	-29°C to 400°C		-29°C to 210°C		-46°C to 150°C		-46°C to 150°C	
10. Material Class	Carbon Steel		Carbon Steel		Duplex Steel		Duplex Steel	
11. Body Material	ASTM A105 or ASTM A216 Gr WCB + Inconel 625 weld overlay (acc. item A.7.1.7.3)		ASTM A105 or ASTM A216 Gr WCB + Inconel 625 weld overlay (acc. item A.7.1.7.3)		ASTM A182 Gr F51 or ASTM A995 Gr 4a		ASTM A182 Gr F51 or ASTM A995 Gr 4a	
12. TRIM Material	N/A		N/A		N/A		N/A	
13. Obturator Material	ASTM A105 + Inconel 625 weld overlay (acc. item A.7.1.7.3)		ASTM A105 + Inconel 625 weld overlay (acc. item A.7.1.7.3)		Duplex (UNS S31803)		Duplex (UNS S31803)	
14. Seat Material	ASTM A105 + Inconel 625 weld overlay (acc. item A.7.1.7.3)		ASTM B564 (UNS N06625) + Inconel 625 weld overlay (acc. item A.7.1.7.3)		Duplex (UNS S31803)		Duplex (UNS S31803)	
15. Spring Material	UNS N07750		UNS N07750		UNS N07750		UNS N07750	
16. Shaft Material	ASTM B637 (UNS N07718)		Not Applicable		ASTM A276 (UNS S31803)		ASTM A276 (UNS S31803)	
17. Additional Requirement	Fire safe design (acc. item A.6.1.5)		Fire safe design (acc. item A.6.1.5)		Fire safe design (acc. item A.6.1.5)		Fire safe design (acc. item A.6.1.5)	
18. Cover Construction	bolted cover		bolted cover		bolted cover		bolted cover	
19. Product testing	FAT according A.9.3		FAT according A.9.3		FAT according A.9.3		FAT according A.9.3	
20. Cladding or Coating	Full clad - Inconel 625 weld overlay on all wetted parts		Full clad - Inconel 625 weld overlay on all wetted parts		N/A		N/A	
21. Notes	N/A		N/A		Wafer valves shall not to be used with flammable services		N/A	

Valve Code	VRE-150-2-D235		VRE-150-2-D315		VRE-150-2-D335		VRE-150-2-S212	
Specs	B11 B26		B12		B12		B3	
1. Valve Type	Check, Flanged type		Check, Flanged type		Check, Flanged type		Check, Wafer type	
2. Sealing Type	Metal to Metal		Metal to Metal		Metal to Metal		Metal to Metal	
3. Valve Specification Level (VSL)	VSL-2		VSL-2		VSL-2		VSL-2	
4. Obturator Type	Axial non-slam		Dual Plate		Axial non-slam		Dual Plate	
5. Standard	API 6D		API 594		API 6D		API 594	
6. Size Range (NPS)	2" - 28"		2" - 36"		2" - 36"		2" - 36"	
7. End Connection	2" - 24"	ASME B16.5, RF	2" - 24"	ASME B16.5, RF	2" - 24"	ASME B16.5, RF	2" - 24"	ASME B16.5, RF
	26" - 28"	ASME B16.47 Series A, RF	26" - 36"	ASME B16.47 Series A, RF	26" - 36"	ASME B16.47 Series A, RF	26" - 36"	ASME B16.47 Series A, RF
8. Pressure Class	150		150		150		150	
9. Temperature	-46°C to 150°C		-46°C to 150°C		-46°C to 150°C		-100°C to 400°C	
10. Material Class	Duplex Steel		Duplex Steel		Duplex Steel		Stainless Steel	
11. Body Material	ASTM A182 Gr F51 or ASTM A995 Gr 4a		ASTM A182 Gr F55 or ASTM A995 Gr 6a		ASTM A182 Gr F55 or ASTM A995 Gr 6a		ASTM A182 Gr F316 or ASTM A351 Gr CF8M	
12. TRIM Material	N/A		N/A		N/A		TRIM 12 according API 594	
13. Obturator Material	Duplex (UNS S31803)		Super Duplex (UNS S32760)		Super Duplex (UNS S32760)		AISI 316	
14. Seat Material	Duplex (UNS S31803)		Super Duplex (UNS S32760)		Super Duplex (UNS S32760)		Stellite (Co-Cr Alloy acc. item A.8.2.1.2)	
15. Spring Material	UNS N07750		UNS N07750		UNS N07750		UNS N07750	
16. Shaft Material	Not Applicable		ASTM A276 (UNS S32760)		Not Applicable		ASTM A276 (UNS S31600)	
17. Additional Requirement	Fire safe design (acc. item A.6.1.5)		Fire safe design (acc. item A.6.1.5)		Fire safe design (acc. item A.6.1.5)		Fire safe design (acc. item A.6.1.5)	
18. Cover Construction	bolted cover		bolted cover		bolted cover		bolted cover	
19. Product testing	FAT according A.9.3		FAT according A.9.3		FAT according A.9.3		FAT according A.9.3	
20. Cladding or Coating	N/A		N/A		N/A		N/A	
21. Notes	N/A		N/A		N/A		Wafer valves shall not to be used with flammable services	

Valve Code	VRE-150-2-S215		VRE-150-2-S235		VRE-150-2-U332	VRE-150-2-U335
Specs	B3		B3		B7 B23	B14 B23
1. Valve Type	Check, Flanged type		Check, Flanged type		Check, Wafer type	Check, Flanged type
2. Sealing Type	Metal to Metal		Metal to Metal		Metal to Metal	Metal to Metal
3. Valve Specification Level (VSL)	VSL-2		VSL-2		VSL-2	VSL-2
4. Obturator Type	Dual Plate		Axial non-slam		Axial non-slam	Axial non-slam
5. Standard	API 594		API 6D		API 6D	API 6D
6. Size Range (NPS)	2" - 36"		2" - 36"		4" - 46"	4" - 46"
7. End Connection	2" - 24"	ASME B16.5, RF	2" - 24"	ASME B16.5, RF	ASME B16.42, RF	ASME B16.42, FF
	26" - 36"	ASME B16.47 Series A, RF	26" - 36"	ASME B16.47 Series A, RF	N/A	N/A
8. Pressure Class	150		150		150	150
9. Temperature	-100°C to 400°C		-46°C to 150°C		0°C to 75°C	0°C to 75°C
10. Material Class	Stainless Steel		Stainless Steel		Uncommon Materials	Uncommon Materials
11. Body Material	ASTM A182 Gr F316 or ASTM A351 Gr CF8M		ASTM A182 Gr F316 or ASTM A351 Gr CF8M		ASTM B148 (UNS C95800)	ASTM B148 (UNS C95800)
12. TRIM Material	TRIM 12 according API 594		N/A		N/A	N/A
13. Obturator Material	AISI 316		AISI 316		ASTM B148 (UNS C95800)	ASTM B148 (UNS C95800)
14. Seat Material	Stellite (Co-Cr Alloy acc. item A.8.2.1.2)		AISI 316		ASTM B148 (UNS C95800)	ASTM B148 (UNS C95800)
15. Spring Material	UNS N07750		UNS N07750		UNS N07750	UNS N07750
16. Shaft Material	ASTM A276 (UNS S31600)		Not Applicable		Not Applicable	Not Applicable
17. Additional Requirement	Fire safe design (acc. item A.6.1.5)		Fire safe design (acc. item A.6.1.5)		N/A	N/A
18. Cover Construction	bolted cover		bolted cover		bolted cover	bolted cover
19. Product testing	FAT according A.9.3		FAT according A.9.3		FAT according A.9.3	FAT according A.9.3
20. Cladding or Coating	N/A		N/A		N/A	N/A
21. Notes	N/A		N/A		Fato-to-face according API 594	N/A

Valve Code	VRE-200-1-U122	VRE-2500-1-C202	VRE-2500-1-D202	VRE-2500-1-D302
Specs	B7R B7 S7	H6	H16	H12
1. Valve Type	Check	Check	Check	Check
2. Sealing Type	Metal to Metal	Metal to Metal	Metal to Metal	Metal to Metal
3. Valve Specification Level (VSL)	VSL-1	VSL-1	VSL-1	VSL-1
4. Obturator Type	Swing	Piston	Piston	Piston
5. Standard	MSS SP-80	ASME B16.34 LTD	ASME B16.34 LTD	ASME B16.34 LTD
6. Size Range (NPS)	½" - 1 ½"	1" - 1 ½"	1" - 1 ½"	1" - 1 ½"
7. End Connection	Screwed ends ASME B1.20.1 NPT	butt weld ASME B16.25	butt weld ASME B16.25	butt weld ASME B16.25
8. Pressure Class	max. press 200 psig	2500	2500	2500
9. Temperature	0°C to 75°C	-46°C to 345°C	-46°C to 150°C	-50°C to 150°C
10. Material Class	Uncommon Materials	Carbon Steel	Duplex Steel	Duplex Steel
11. Body Material	ASTM B62 (UNS C83600)	ASTM A350 Gr LF2 CL1	ASTM A182 Gr F51	ASTM A182 Gr F55
12. TRIM Material	TRIM AA according API 594	TRIM 12 according API 594	N/A	N/A
13. Obturator Material	ASTM B62 (UNS C83600)	AISI 316	Duplex (UNS S31803)	Super Duplex (UNS S32760)
14. Seat Material	ASTM B62 (UNS C83600)	Stellite (Co-Cr Alloy acc. item A.8.2.1.2)	Duplex (UNS S31803)	Super Duplex (UNS S32760)
15. Spring Material	N/A	N/A	N/A	N/A
16. Shaft Material	Not Applicable	Not Applicable	Not Applicable	Not Applicable
17. Operator Type	N/A	N/A	N/A	N/A
18. Additional Requirement	N/A	Fire safe design (acc. item A.6.1.5)	Fire safe design (acc. item A.6.1.5)	Fire safe design (acc. item A.6.1.5)
19. Cover Construction	screwed cover	bolted cover	bolted cover	bolted cover
20. Product testing	FAT according A.9.3	FAT according A.9.3	FAT according A.9.3	FAT according A.9.3
21. Notes	N/A	N/A	N/A	N/A

Valve Code	VRE-2500-1-N102	VRE-2500-2-C102	VRE-2500-2-C115	VRE-2500-2-C135
Specs	H30	H10	H10	H10
1. Valve Type	Check	Check	Check	Check
2. Sealing Type	Metal to Metal	Metal to Metal	Metal to Metal	Metal to Metal
3. Valve Specification Level (VSL)	VSL-1	VSL-2	VSL-2	VSL-2
4. Obturator Type	Piston	Piston	Dual Plate	Axial non-slam
5. Standard	ASME B16.34 LTD	ASME B16.34 LTD	API 594	API 6D
6. Size Range (NPS)	1" - 1 ½"	1" - 1 ½"	2" - 12"	2" - 12"
7. End Connection	butt weld ASME B16.25	butt weld ASME B16.25	N/A	N/A
8. Pressure Class	2500	2500	2500	2500
9. Temperature	-100°C to 400°C	-29°C to 400°C	-29°C to 400°C	-29°C to 200°C
10. Material Class	Nickel Alloys	Carbon Steel	Carbon Steel	Carbon Steel
11. Body Material	ASTM B564 (UNS N06625)	ASTM A105	ASTM A105	ASTM A105
12. TRIM Material	N/A	TRIM 8 according API 594	TRIM 8 according API 594	N/A
13. Obturator Material	ASTM B564 (UNS N06625)	AISI 410	AISI 410	AISI 410
14. Seat Material	ASTM B564 (UNS N06625)	Stellite (Co-Cr Alloy acc. item A.8.2.1.2)	Stellite (Co-Cr Alloy acc. item A.8.2.1.2)	AISI 410
15. Spring Material	N/A	N/A	UNS N07750	UNS N07750
16. Shaft Material	Not Applicable	Not Applicable	ASTM A276 (UNS S41000)	Not Applicable
17. Operator Type	N/A	N/A	N/A	N/A
18. Additional Requirement	Fire safe design (acc. item A.6.1.5)	Fire safe design (acc. item A.6.1.5)	Fire safe design (acc. item A.6.1.5)	Fire safe design (acc. item A.6.1.5)
19. Cover Construction	bolted cover	bolted cover	bolted cover	bolted cover
20. Product testing	FAT according A.9.3	FAT according A.9.3	FAT according A.9.3	FAT according A.9.3
21. Notes	N/A	N/A	N/A	N/A

Valve Code	VRE-2500-2-C213	VRE-2500-2-C215		VRE-2500-2-C235		VRE-2500-2-C512
Specs	H6	H6		H6		H30
1. Valve Type	Check, Wafer type	Check, Flanged type		Check, Flanged type		Check, Wafer type
2. Sealing Type	Metal to Metal	Metal to Metal		Metal to Metal		Metal to Metal
3. Valve Specification Level (VSL)	VSL-2	VSL-2		VSL-2		VSL-2
4. Obturator Type	Dual Plate	Dual Plate		Axial non-slam		Dual Plate
5. Standard	API 594	API 594		API 6D		API 594
6. Size Range (NPS)	2" - 18"	2" - 18"		2" - 18"		2" - 12"
7. End Connection	ASME B16.5, RTJ	2" - 12"	ASME B16.5, RTJ	2" - 12"	ASME B16.5, RTJ	ASME B16.5, RTJ
	N/A	14" - 18"	ISO 27509, IX	14" - 18"	ISO 27509, IX	N/A
8. Pressure Class	2500	2500		2500		2500
9. Temperature	-46°C to 345°C	-46°C to 200°C		-46°C to 345°C		-29°C to 150°C
10. Material Class	Carbon Steel	Carbon Steel		Carbon Steel		Carbon Steel
11. Body Material	ASTM A350 Gr LF2 CL1	ASTM A350 Gr LF2 CL1		ASTM A350 Gr LF2 CL1		ASTM A105 + Inconel 625 weld overlay (acc. item A.7.1.7.3)
12. TRIM Material	TRIM 12 according API 594	TRIM 12 according API 594		N/A		N/A
13. Obturator Material	AISI 316	AISI 316		AISI 316		ASTM A105 + Inconel 625 weld overlay (acc. item A.7.1.7.3)
14. Seat Material	Stellite (Co-Cr Alloy acc. item A.8.2.1.2)	Stellite (Co-Cr Alloy acc. item A.8.2.1.2)		AISI 316		ASTM A105 + Inconel 625 weld overlay (acc. item A.7.1.7.3)
15. Spring Material	UNS N07750	UNS N07750		UNS N07750		UNS N07750
16. Shaft Material	ASTM A276 (UNS S31600)	ASTM A276 (UNS S31600)		Not Applicable		ASTM B637 (UNS N07718)
17. Additional Requirement	Fire safe design (acc. item A.6.1.5)	Fire safe design (acc. item A.6.1.5)		Fire safe design (acc. item A.6.1.5)		Fire safe design (acc. item A.6.1.5)
18. Cover Construction	bolted cover	bolted cover		bolted cover		bolted cover
19. Product testing	FAT according A.9.3	FAT according A.9.3		FAT according A.9.3		FAT according A.9.3
20. Cladding or Coating	N/A	N/A		N/A		Full clad - Inconel 625 weld overlay on all wetted parts
21. Notes	Wafer valves shall not be used with flammable services	N/A		N/A		N/A

Valve Code	VRE-2500-2-C515		VRE-2500-2-C535		VRE-2500-2-D212	VRE-2500-2-D215	
Specs	H30		H30		H16	H16	
1. Valve Type	Check, Flanged type		Check, Flanged type		Check, Wafer type	Check, Flanged type	
2. Sealing Type	Metal to Metal		Metal to Metal		Metal to Metal	Metal to Metal	
3. Valve Specification Level (VSL)	VSL-2		VSL-2		VSL-2	VSL-2	
4. Obturator Type	Dual Plate		Axial non-slam		Dual Plate	Dual Plate	
5. Standard	API 594		API 6D		API 594	API 594	
6. Size Range (NPS)	2" - 16"		2" - 16"		2" - 12"	2" - 16"	
7. End Connection	2" - 12"	ASME B16.5, RTJ	2" - 12"	ASME B16.5, RTJ	ASME B16.5, RTJ	2" - 12"	ASME B16.5, RTJ
	14" - 16"	ISO 27509, IX	14" - 16"	ISO 27509, IX	N/A	14" - 16"	ISO 27509, IX
8. Pressure Class	2500		2500		2500	2500	
9. Temperature	-29°C to 150°C		-29°C to 200°C		-46°C to 150°C	-46°C to 150°C	
10. Material Class	Carbon Steel		Carbon Steel		Duplex Steel	Duplex Steel	
11. Body Material	ASTM A105 + Inconel 625 weld overlay (acc. item A.7.1.7.3)		ASTM A105 + Inconel 625 weld overlay (acc. item A.7.1.7.3)		ASTM A182 Gr F51	ASTM A182 Gr F51	
12. TRIM Material	N/A		N/A		N/A	N/A	
13. Obturator Material	ASTM A105 + Inconel 625 weld overlay (acc. item A.7.1.7.3)		ASTM A105 + Inconel 625 weld overlay (acc. item A.7.1.7.3)		Duplex (UNS S31803)	Duplex (UNS S31803)	
14. Seat Material	ASTM A105 + Inconel 625 weld overlay (acc. item A.7.1.7.3)		ASTM A105 + Inconel 625 weld overlay (acc. item A.7.1.7.3)		Duplex (UNS S31803)	Duplex (UNS S31803)	
15. Spring Material	UNS N07750		UNS N07750		UNS N07750	UNS N07750	
16. Shaft Material	ASTM B637 (UNS N07718)		Not Applicable		ASTM A276 (UNS S31803)	ASTM A276 (UNS S31803)	
17. Additional Requirement	Fire safe design (acc. item A.6.1.5)		Fire safe design (acc. item A.6.1.5)		Fire safe design (acc. item A.6.1.5)	Fire safe design (acc. item A.6.1.5)	
18. Cover Construction	bolted cover		bolted cover		bolted cover	bolted cover	
19. Product testing	FAT according A.9.3		FAT according A.9.3		FAT according A.9.3	FAT according A.9.3	
20. Cladding or Coating	Full clad - Inconel 625 weld overlay on all wetted parts		Full clad - Inconel 625 weld overlay on all wetted parts		N/A	N/A	
21. Notes	N/A		N/A		Wafer valves shall not to be used with flammable services	N/A	

Valve Code	VRE-2500-2-D235	VRE-2500-2-D315		VRE-2500-2-D335	VRE-2500-2-S202
Specs	H16	H12P H12		H12	H3
1. Valve Type	Check, Flanged type	Check, Flanged type		Check, Flanged type	Check
2. Sealing Type	Metal to Metal	Metal to Metal		Metal to Metal	Metal to Metal
3. Valve Specification Level (VSL)	VSL-2	VSL-2		VSL-2	VSL-2
4. Obturator Type	Axial non-slam	Dual Plate		Axial non-slam	Piston
5. Standard	API 6D	API 594		API 6D	ASME B16.34 LTD
6. Size Range (NPS)	2" - 12"	2" - 14"		2" - 12"	1" - 1 ½"
7. End Connection	ASME B16.5, RTJ	2" - 12"	ASME B16.5, RTJ	ASME B16.5, RTJ	N/A
	N/A	14"	ISO 27509, IX	N/A	N/A
8. Pressure Class	2500	2500		2500	2500
9. Temperature	-46°C to 150°C	-50°C to 150°C		-50°C to 260°C	-100°C to 400°C
10. Material Class	Duplex Steel	Duplex Steel		Duplex Steel	Stainless Steel
11. Body Material	ASTM A182 Gr F51	ASTM A182 Gr F55		ASTM A182 Gr F55	ASTM A182 Gr F316/316L
12. TRIM Material	N/A	N/A		N/A	TRIM 12 according API 594
13. Obturator Material	Duplex (UNS S31803)	Super Duplex (UNS S32760)		ASTM A182 Gr F55	AISI 316L
14. Seat Material	Duplex (UNS S31803)	Super Duplex (UNS S32760)		ASTM A182 Gr F55	Stellite (Co-Cr Alloy acc. item A.8.2.1.2)
15. Spring Material	UNS N07750	UNS N07750		UNS N07750	N/A
16. Shaft Material	ASTM A276 (UNS S31803)	ASTM A276 (UNS S32760)		Not Applicable	Not Applicable
17. Additional Requirement	Fire safe design (acc. item A.6.1.5)	Fire safe design (acc. item A.6.1.5)		Fire safe design (acc. item A.6.1.5)	Fire safe design (acc. item A.6.1.5)
18. Cover Construction	bolted cover	bolted cover		bolted cover	bolted cover
19. Product testing	FAT according A.9.3	FAT according A.9.3		FAT according A.9.3	FAT according A.9.3
20. Cladding or Coating	N/A	N/A		N/A	N/A
21. Notes	N/A	N/A		N/A	N/A

Valve Code	VRE-2500-2-S212	VRE-2500-2-S215		VRE-2500-2-S235		VRE-2510-2-C115
Specs	H3	H3		H3		H10
1. Valve Type	Check, Wafer type	Check, Flanged type		Check, Flanged type		Check, Flanged type
2. Sealing Type	Metal to Metal	Metal to Metal		Metal to Metal		Metal to Metal
3. Valve Specification Level (VSL)	VSL-2	VSL-2		VSL-2		VSL-2
4. Obturator Type	Dual Plate	Dual Plate		Axial non-slam		Dual Plate
5. Standard	API 594	API 594		API 6D		API 594
6. Size Range (NPS)	2" - 12"	2" - 16"		2" - 16"		2" - 12"
7. End Connection	ASME B16.5, RTJ	2" - 12"	ASME B16.5, RTJ	2" - 12"	ASME B16.5, RTJ	ISO 27509, IX
	N/A	14" - 16"	ISO 27509, IX	14" - 16"	ISO 27509, IX	N/A
8. Pressure Class	2500	2500		2500		2500
9. Temperature	-46°C to 210°C	-100°C to 210°C		-100°C to 210°C		-29°C to 400°C
10. Material Class	Stainless Steel	Stainless Steel		Stainless Steel		Carbon Steel
11. Body Material	ASTM A182 Gr F316	ASTM A182 Gr F316		ASTM A182 Gr F316 or ASTM A351 Gr CF8M		ASTM A105
12. TRIM Material	TRIM 12 according API 594	TRIM 12 according API 594		N/A		TRIM 8 according API 594
13. Obturator Material	AISI 316	AISI 316		AISI 316		AISI 410
14. Seat Material	Stellite (Co-Cr Alloy acc. item A.8.2.1.2)	Stellite (Co-Cr Alloy acc. item A.8.2.1.2)		AISI 316		Stellite (Co-Cr Alloy acc. item A.8.2.1.2)
15. Spring Material	UNS N07750	UNS N07750		UNS N07750		UNS N07750
16. Shaft Material	ASTM A276 (UNS S31600)	ASTM A276 (UNS S31600)		Not Applicable		ASTM A276 (UNS S41000)
17. Additional Requirement	Fire safe design (acc. item A.6.1.5)	Fire safe design (acc. item A.6.1.5)		Fire safe design (acc. item A.6.1.5)		Fire safe design (acc. item A.6.1.5)
18. Cover Construction	bolted cover	bolted cover		bolted cover		bolted cover
19. Product testing	FAT according A.9.3	FAT according A.9.3		FAT according A.9.3		FAT according A.9.3
20. Cladding or Coating	N/A	N/A		N/A		N/A
21. Notes	Wafer valves shall not be used with flammable services	N/A		N/A		N/A

Valve Code	VRE-2510-2-C135	VRE-2510-2-C213	VRE-2510-2-C215	VRE-2510-2-C235
Specs	H10	H6	H6	H6
1. Valve Type	Check, Flanged type	Check, Wafer type	Check, Flanged type	Check, Flanged type
2. Sealing Type	Metal to Metal	Metal to Metal	Metal to Metal	Metal to Metal
3. Valve Specification Level (VSL)	VSL-2	VSL-2	VSL-2	VSL-2
4. Obturator Type	Axial non-slam	Dual Plate	Dual Plate	Axial non-slam
5. Standard	API 6D	API 594	API 594	API 6D
6. Size Range (NPS)	2" - 12"	2" - 18"	2" - 18"	2" - 18"
7. End Connection	ISO 27509, IX	ASME B16.5, RTJ	ISO 27509, IX	ISO 27509, IX
8. Pressure Class	2500	2500	2500	2500
9. Temperature	-29°C to 200°C	-46°C to 345°C	-46°C to 200°C	-46°C to 345°C
10. Material Class	Carbon Steel	Carbon Steel	Carbon Steel	Carbon Steel
11. Body Material	ASTM A105	ASTM A350 Gr LF2 CL1	ASTM A350 Gr LF2 CL1	ASTM A350 Gr LF2 CL1
12. TRIM Material	N/A	TRIM 12 according API 594	TRIM 12 according API 594	N/A
13. Obturator Material	AISI 410	AISI 316	AISI 316	AISI 316
14. Seat Material	AISI 410	Stellite (Co-Cr Alloy acc. item A.8.2.1.2)	Stellite (Co-Cr Alloy acc. item A.8.2.1.2)	AISI 316
15. Spring Material	UNS N07750	UNS N07750	UNS N07750	UNS N07750
16. Shaft Material	Not Applicable	ASTM A276 (UNS S31600)	ASTM A276 (UNS S31600)	Not Applicable
17. Additional Requirement	Fire safe design (acc. item A.6.1.5)	Fire safe design (acc. item A.6.1.5)	Fire safe design (acc. item A.6.1.5)	Fire safe design (acc. item A.6.1.5)
18. Cover Construction	bolted cover	bolted cover	bolted cover	bolted cover
19. Product testing	FAT according A.9.3	FAT according A.9.3	FAT according A.9.3	FAT according A.9.3
20. Cladding or Coating	N/A	N/A	N/A	N/A
21. Notes	N/A	Wafer valves shall not to be used with flammable services	N/A	N/A

Valve Code	VRE-2510-2-C512	VRE-2510-2-C515	VRE-2510-2-C535	VRE-2510-2-D212
Specs	H30	H30	H30	H16
1. Valve Type	Check, Wafer type	Check, Flanged type	Check, Flanged type	Check, Wafer type
2. Sealing Type	Metal to Metal	Metal to Metal	Metal to Metal	Metal to Metal
3. Valve Specification Level (VSL)	VSL-2	VSL-2	VSL-2	VSL-2
4. Obturator Type	Dual Plate	Dual Plate	Axial non-slam	Dual Plate
5. Standard	API 594	API 594	API 6D	API 594
6. Size Range (NPS)	2" - 16"	2" - 16"	2" - 16"	2" - 12"
7. End Connection	ISO 27509, IX	ISO 27509, IX	ISO 27509, IX	ISO 27509, IX
8. Pressure Class	2500	2500	2500	2500
9. Temperature	-29°C to 150°C	-29°C to 150°C	-29°C to 200°C	-46°C to 150°C
10. Material Class	Carbon Steel	Carbon Steel	Carbon Steel	Duplex Steel
11. Body Material	ASTM A105 + Inconel 625 weld overlay (acc. item A.7.1.7.3)	ASTM A105 + Inconel 625 weld overlay (acc. item A.7.1.7.3)	ASTM A105 + Inconel 625 weld overlay (acc. item A.7.1.7.3)	ASTM A182 Gr F51
12. TRIM Material	N/A	N/A	N/A	N/A
13. Obturator Material	ASTM A105 + Inconel 625 weld overlay (acc. item A.7.1.7.3)	ASTM A105 + Inconel 625 weld overlay (acc. item A.7.1.7.3)	ASTM A105 + Inconel 625 weld overlay (acc. item A.7.1.7.3)	Duplex (UNS S31803)
14. Seat Material	ASTM A105 + Inconel 625 weld overlay (acc. item A.7.1.7.3)	ASTM A105 + Inconel 625 weld overlay (acc. item A.7.1.7.3)	ASTM A105 + Inconel 625 weld overlay (acc. item A.7.1.7.3)	Duplex (UNS S31803)
15. Spring Material	UNS N07750	UNS N07750	UNS N07750	UNS N07750
16. Shaft Material	ASTM B637 (UNS N07718)	ASTM B637 (UNS N07718)	Not Applicable	ASTM A276 (UNS S31803)
17. Additional Requirement	Fire safe design (acc. item A.6.1.5)	Fire safe design (acc. item A.6.1.5)	Fire safe design (acc. item A.6.1.5)	Fire safe design (acc. item A.6.1.5)
18. Cover Construction	bolted cover	bolted cover	bolted cover	bolted cover
19. Product testing	FAT according A.9.3	FAT according A.9.3	FAT according A.9.3	FAT according A.9.3
20. Cladding or Coating	Full clad - Inconel 625 weld overlay on all wetted parts	Full clad - Inconel 625 weld overlay on all wetted parts	Full clad - Inconel 625 weld overlay on all wetted parts	N/A
21. Notes	N/A	N/A	N/A	Wafer valves shall not to be used with flammable services

Valve Code	VRE-2510-2-D215	VRE-2510-2-D235	VRE-2510-2-D315	VRE-2510-2-D335
Specs	H16	H16	H12P H12	H12
1. Valve Type	Check, Flanged type	Check, Flanged type	Check, Flanged type	Check, Flanged type
2. Sealing Type	Metal to Metal	Metal to Metal	Metal to Metal	Metal to Metal
3. Valve Specification Level (VSL)	VSL-2	VSL-2	VSL-2	VSL-2
4. Obturator Type	Dual Plate	Axial non-slam	Dual Plate	Axial non-slam
5. Standard	API 594	API 6D	API 594	API 6D
6. Size Range (NPS)	2" - 12"	2" - 12"	2" - 14"	2" - 12"
7. End Connection	ISO 27509, IX	ISO 27509, IX	ISO 27509, IX	ISO 27509, IX
8. Pressure Class	2500	2500	2500	2500
9. Temperature	-46°C to 150°C	-46°C to 150°C	-50°C to 150°C	-50°C to 260°C
10. Material Class	Duplex Steel	Duplex Steel	Duplex Steel	Duplex Steel
11. Body Material	ASTM A182 Gr F51	ASTM A182 Gr F51	ASTM A182 Gr F55	ASTM A182 Gr F55
12. TRIM Material	N/A	N/A	N/A	N/A
13. Obturator Material	Duplex (UNS S31803)	Duplex (UNS S31803)	Super Duplex (UNS S32760)	ASTM A182 Gr F55
14. Seat Material	Duplex (UNS S31803)	Duplex (UNS S31803)	Super Duplex (UNS S32760)	ASTM A182 Gr F55
15. Spring Material	UNS N07750	UNS N07750	UNS N07750	UNS N07750
16. Shaft Material	ASTM A276 (UNS S31803)	ASTM A276 (UNS S31803)	ASTM A276 (UNS S32760)	Not Applicable
17. Additional Requirement	Fire safe design (acc. item A.6.1.5)	Fire safe design (acc. item A.6.1.5)	Fire safe design (acc. item A.6.1.5)	Fire safe design (acc. item A.6.1.5)
18. Cover Construction	bolted cover	bolted cover	bolted cover	bolted cover
19. Product testing	FAT according A.9.3	FAT according A.9.3	FAT according A.9.3	FAT according A.9.3
20. Cladding or Coating	N/A	N/A	N/A	N/A
21. Notes	N/A	N/A	N/A	N/A

Valve Code	VRE-2510-2-S212	VRE-2510-2-S215	VRE-2510-2-S235	VRE-300-1-C111
Specs	H3	H3	H3	C8 C9 C10 R9C S9C
1. Valve Type	Check, Wafer type	Check, Flanged type	Check, Flanged type	Check, Wafer type
2. Sealing Type	Metal to Metal	Metal to Metal	Metal to Metal	Soft
3. Valve Specification Level (VSL)	VSL-2	VSL-2	VSL-2	VSL-1
4. Obturator Type	Dual Plate	Dual Plate	Axial non-slam	Dual Plate
5. Standard	API 594	API 594	API 6D	API 594
6. Size Range (NPS)	2" - 16"	2" - 16"	2" - 16"	2" - 24"
7. End Connection	ISO 27509, IX	ISO 27509, IX	ISO 27509, IX	ASME B16.5
8. Pressure Class	2500	2500	2500	300
9. Temperature	-46°C to 210°C	-100°C to 210°C	-100°C to 210°C	0°C to 150°C
10. Material Class	Stainless Steel	Stainless Steel	Stainless Steel	Carbon Steel
11. Body Material	ASTM A182 Gr F316	ASTM A182 Gr F316	ASTM A182 Gr F316 or ASTM A351 Gr CF8M	ASTM A105 or ASTM A216 Gr WCB
12. TRIM Material	TRIM 12 according API 594	TRIM 12 according API 594	N/A	TRIM 1 according API 594
13. Obturator Material	AISI 316	AISI 316	AISI 316	AISI 410
14. Seat Material	Stellite (Co-Cr Alloy acc. item A.8.2.1.2)	Stellite (Co-Cr Alloy acc. item A.8.2.1.2)	AISI 316	Group A (acc. item A.7.3.3.1)
15. Spring Material	UNS N07750	UNS N07750	UNS N07750	UNS N07750
16. Shaft Material	ASTM A276 (UNS S31600)	ASTM A276 (UNS S31600)	Not Applicable	ASTM A276 (UNS S41000)
17. Additional Requirement	Fire safe design (acc. item A.6.1.5)	Fire safe design (acc. item A.6.1.5)	Fire safe design (acc. item A.6.1.5)	N/A
18. Cover Construction	bolted cover	bolted cover	bolted cover	bolted cover
19. Product testing	FAT according A.9.3	FAT according A.9.3	FAT according A.9.3	FAT according A.9.3
20. Cladding or Coating	N/A	N/A	N/A	N/A
21. Notes	Wafer valves shall not be used with flammable services	N/A	N/A	Wafer valves shall not be used with flammable services

Valve Code	VRE-300-1-C211		VRE-300-1-C512		VRE-300-1-D211	VRE-300-1-D212
Specs	C6 C19		C30		C11 C16	C11
1. Valve Type	Check, Wafer type		Check, Wafer type		Check, Wafer type	Check, Wafer type
2. Sealing Type	Soft		Metal to Metal		Soft	Metal to Metal
3. Valve Specification Level (VSL)	VSL-1		VSL-1		VSL-1	VSL-1
4. Obturator Type	Dual Plate		Dual Plate		Dual Plate	Dual Plate
5. Standard	API 594		API 594		API 594	API 594
6. Size Range (NPS)	2" - 30"		2" - 26"		2" - 24"	2" - 16"
7. End Connection	2" - 24"	ASME B16.5, RF	2" - 24"	ASME B16.5, RF	ASME B16.5, RF	ASME B16.5, RF
	26" - 30"	ASME B16.47 Series A, RF	26"	ASME B16.47 Series A, RF	N/A	N/A
8. Pressure Class	300		300		300	300
9. Temperature	0°C to 150°C		-29°C to 400°C		0°C to 150°C	-46°C to 150°C
10. Material Class	Carbon Steel		Carbon Steel		Duplex Steel	Duplex Steel
11. Body Material	ASTM A350 Gr LF2 CL1 or ASTM A352 Gr LCB		ASTM A105 or ASTM A216 Gr WCB + Inconel 625 weld overlay (acc. item A.7.1.7.3)		ASTM A182 Gr F51 or ASTM A995 Gr 4a	ASTM A182 Gr F51 or ASTM A995 Gr 4a
12. TRIM Material	TRIM 10 according API 594		N/A		N/A	N/A
13. Obturator Material	AISI 316		ASTM A105 + Inconel 625 weld overlay (acc. item A.7.1.7.3)		Duplex (UNS S31803)	Duplex (UNS S31803)
14. Seat Material	Group A (acc. item A.7.3.3.1)		ASTM A105 + Inconel 625 weld overlay (acc. item A.7.1.7.3)		Group A (acc. item A.7.3.3.1)	Duplex (UNS S31803)
15. Spring Material	UNS N07750		UNS N07750		UNS N07750	UNS N07750
16. Shaft Material	ASTM A276 (UNS S31600)		ASTM B637 (UNS N07718)		ASTM A276 (UNS S31803)	ASTM A276 (UNS S31803)
17. Additional Requirement	N/A		Fire safe design (acc. item A.6.1.5)		N/A	Fire safe design (acc. item A.6.1.5)
18. Cover Construction	bolted cover		bolted cover		bolted cover	bolted cover
19. Product testing	FAT according A.9.3		FAT according A.9.3		FAT according A.9.3	FAT according A.9.3
20. Cladding or Coating	N/A		Full clad - Inconel 625 weld overlay on all wetted parts		N/A	N/A
21. Notes	Wafer valves shall not to be used with flammable services		N/A		Wafer valves shall not to be used with flammable services	Wafer valves shall not to be used with flammable services

Valve Code	VRE-300-1-D312		VRE-300-1-S211		VRE-300-1-U311	VRE-300-1-U312
Specs	C12		C3 R3C S3C		C23	C23
1. Valve Type	Check, Wafer type		Check, Wafer type		Check, Wafer type	Check, Wafer type
2. Sealing Type	Metal to Metal		Soft		Soft	Metal to Metal
3. Valve Specification Level (VSL)	VSL-1		VSL-1		VSL-1	VSL-1
4. Obturator Type	Dual Plate		Dual Plate		Dual Plate	Dual Plate
5. Standard	API 594		API 594		API 594	API 594
6. Size Range (NPS)	2" - 30"		2" - 30"		2" - 28"	2" - 28"
7. End Connection	2" - 24"	ASME B16.5, RF	2" - 24"	ASME B16.5, RF	ASME B16.42, RF	ASME B16.42, RF
	26" - 30"	ASME B16.47 Series A, RF	26" - 30"	ASME B16.47 Series A, RF	N/A	N/A
8. Pressure Class	300		300		300	300
9. Temperature	-50°C to 150°C		0°C to 150°C		0°C to 75°C	0°C to 75°C
10. Material Class	Duplex Steel		Stainless Steel		Uncommon Materials	Uncommon Materials
11. Body Material	ASTM A182 Gr F55 or ASTM A995 Gr 6a		ASTM A182 Gr F316 or ASTM A351 Gr CF8M		ASTM B148 (UNS C95800)	ASTM B148 (UNS C95800)
12. TRIM Material	N/A		TRIM 10 according API 594		N/A	N/A
13. Obturator Material	Super Duplex (UNS S32760)		AISI 316		ASTM B148 (UNS C95800)	ASTM B148 (UNS C95800)
14. Seat Material	Super Duplex (UNS S32760)		Group A (acc. item A.7.3.3.1)		Group A (acc. item A.7.3.3.1)	ASTM B148 (UNS C95800)
15. Spring Material	UNS N07750		UNS N07750		UNS N07750	UNS N07750
16. Shaft Material	ASTM A276 (UNS S32760)		ASTM A276 (UNS S31600)		ASTM B150 (UNS C63200)	ASTM B150 (UNS C63200)
17. Additional Requirement	Fire safe design (acc. item A.6.1.5)		N/A		N/A	N/A
18. Cover Construction	bolted cover		bolted cover		bolted cover	bolted cover
19. Product testing	FAT according A.9.3		FAT according A.9.3		FAT according A.9.3	FAT according A.9.3
20. Cladding or Coating	N/A		N/A		N/A	N/A
21. Notes	Wafer valves shall not to be used with flammable services		Wafer valves shall not to be used with flammable services		Wafer valves shall not to be used with flammable services	Wafer valves shall not to be used with flammable services

Valve Code	VRE-300-2-C112	VRE-300-2-C113	VRE-300-2-C115	VRE-300-2-C135
Specs	C9 C10	C4 S9C	C9 C10	C4 C9 C10
1. Valve Type	Check, Wafer type	Check, Wafer type	Check, Flanged type	Check, Flanged type
2. Sealing Type	Metal to Metal	Metal to Metal	Metal to Metal	Metal to Metal
3. Valve Specification Level (VSL)	VSL-2	VSL-2	VSL-2	VSL-2
4. Obturator Type	Dual Plate	Dual Plate	Dual Plate	Axial non-slam
5. Standard	API 594	API 594	API 594	API 6D
6. Size Range (NPS)	2" - 24"	2" - 24"	2" - 24"	2" - 24"
7. End Connection	ASME B16.5, RF	ASME B16.5, RF	ASME B16.5, RF	ASME B16.5, RF
8. Pressure Class	300	300	300	300
9. Temperature	-29°C to 400°C	-29°C to 400°C	-29°C to 400°C	-29°C to 210°C
10. Material Class	Carbon Steel	Carbon Steel	Carbon Steel	Carbon Steel
11. Body Material	ASTM A105 or ASTM A216 Gr WCB	ASTM A105 or ASTM A216 Gr WCB	ASTM A105 or ASTM A216 Gr WCB	ASTM A105 or ASTM A216 Gr WCB
12. TRIM Material	TRIM 8 according API 594	TRIM 5 according API 594	TRIM 8 according API 594	N/A
13. Obturator Material	AISI 410	Stellite (Co-Cr Alloy acc. item A.8.2.1.2)	AISI 410	AISI 410
14. Seat Material	Stellite (Co-Cr Alloy acc. item A.8.2.1.2)	Stellite (Co-Cr Alloy acc. item A.8.2.1.2)	Stellite (Co-Cr Alloy acc. item A.8.2.1.2)	AISI 410
15. Spring Material	UNS N07750	UNS N07750	UNS N07750	UNS N07750
16. Shaft Material	ASTM A276 (UNS S41000)	ASTM A276 (UNS S41000)	ASTM A276 (UNS S41000)	Not Applicable
17. Additional Requirement	Fire safe design (acc. item A.6.1.5)	Fire safe design (acc. item A.6.1.5)	Fire safe design (acc. item A.6.1.5)	Fire safe design (acc. item A.6.1.5)
18. Cover Construction	bolted cover	bolted cover	bolted cover	bolted cover
19. Product testing	FAT according A.9.3	FAT according A.9.3	FAT according A.9.3	FAT according A.9.3
20. Cladding or Coating	N/A	N/A	N/A	N/A
21. Notes	Wafer valves shall not to be used with flammable services	Wafer valves shall not to be used with flammable services	N/A	N/A

Valve Code	VRE-300-2-C212		VRE-300-2-C215		VRE-300-2-C235		VRE-300-2-C512	
Specs	C6 C19		C6 C19		C6 C19		C30	
1. Valve Type	Check, Wafer type		Check, Flanged type		Check, Flanged type		Check, Wafer type	
2. Sealing Type	Metal to Metal		Metal to Metal		Metal to Metal		Metal to Metal	
3. Valve Specification Level (VSL)	VSL-2		VSL-2		VSL-2		VSL-2	
4. Obturator Type	Dual Plate		Dual Plate		Axial non-slam		Dual Plate	
5. Standard	API 594		API 594		API 6D		API 594	
6. Size Range (NPS)	2" - 30"		2" - 30"		2" - 30"		2" - 26"	
7. End Connection	2" - 24"	ASME B16.5, RF	2" - 24"	ASME B16.5, RF	2" - 24"	ASME B16.5, RF	2" - 24"	ASME B16.5, RF
	26" - 30"	ASME B16.47 Series A, RF	26" - 30"	ASME B16.47 Series A, RF	26" - 30"	ASME B16.47 Series A, RF	26"	ASME B16.47 Series A, RF
8. Pressure Class	300		300		300		300	
9. Temperature	-46°C to 345°C		-46°C to 345°C		-46°C to 210°C		-29°C to 400°C	
10. Material Class	Carbon Steel		Carbon Steel		Carbon Steel		Carbon Steel	
11. Body Material	ASTM A350 Gr LF2 CL1 or ASTM A352 Gr LCB		ASTM A350 Gr LF2 CL1 or ASTM A352 Gr LCB		ASTM A350 Gr LF2 CL1 or ASTM A352 Gr LCB		ASTM A105 or ASTM A216 Gr WCB + Inconel 625 weld overlay (acc. item A.7.1.7.3)	
12. TRIM Material	TRIM 12 according API 594		TRIM 12 according API 594		N/A		N/A	
13. Obturator Material	AISI 316		AISI 316		AISI 316		ASTM A105 + Inconel 625 weld overlay (acc. item A.7.1.7.3)	
14. Seat Material	Stellite (Co-Cr Alloy acc. item A.8.2.1.2)		Stellite (Co-Cr Alloy acc. item A.8.2.1.2)		AISI 410		ASTM A105 + Inconel 625 weld overlay (acc. item A.7.1.7.3)	
15. Spring Material	UNS N07750		UNS N07750		UNS N07750		UNS N07750	
16. Shaft Material	ASTM A276 (UNS S31600)		ASTM A276 (UNS S31600)		Not Applicable		ASTM B637 (UNS N07718)	
17. Additional Requirement	Fire safe design (acc. item A.6.1.5)		Fire safe design (acc. item A.6.1.5)		Fire safe design (acc. item A.6.1.5)		Fire safe design (acc. item A.6.1.5)	
18. Cover Construction	bolted cover		bolted cover		bolted cover		bolted cover	
19. Product testing	FAT according A.9.3		FAT according A.9.3		FAT according A.9.3		FAT according A.9.3	
20. Cladding or Coating	N/A		N/A		N/A		Full clad - Inconel 625 weld overlay on all wetted parts	
21. Notes	Wafer valves shall not be used with flammable services		N/A		N/A		N/A	

Valve Code	VRE-300-2-C515		VRE-300-2-C535		VRE-300-2-D212	VRE-300-2-D215
Specs	C30		C30		C11 C16	C16
1. Valve Type	Check, Flanged type		Check, Flanged type		Check, Wafer type	Check, Flanged type
2. Sealing Type	Metal to Metal		Metal to Metal		Metal to Metal	Metal to Metal
3. Valve Specification Level (VSL)	VSL-2		VSL-2		VSL-2	VSL-2
4. Obturator Type	Dual Plate		Axial non-slam		Dual Plate	Dual Plate
5. Standard	API 594		API 6D		API 594	API 594
6. Size Range (NPS)	2" - 26"		2" - 26"		2" - 24"	2" - 24"
7. End Connection	2" - 24"	ASME B16.5, RF	2" - 24"	ASME B16.5, RF	ASME B16.5, RF	ASME B16.5, RF
	26"	ASME B16.47 Series A, RF	26"	ASME B16.47 Series A, RF	N/A	N/A
8. Pressure Class	300		300		300	300
9. Temperature	-29°C to 400°C		-29°C to 210°C		-46°C to 150°C	-46°C to 150°C
10. Material Class	Carbon Steel		Carbon Steel		Duplex Steel	Duplex Steel
11. Body Material	ASTM A105 or ASTM A216 Gr WCB + Inconel 625 weld overlay (acc. item A.7.1.7.3)		ASTM A105 or ASTM A216 Gr WCB + Inconel 625 weld overlay (acc. item A.7.1.7.3)		ASTM A182 Gr F51 or ASTM A995 Gr 4a	ASTM A182 Gr F51 or ASTM A995 Gr 4a
12. TRIM Material	N/A		N/A		N/A	N/A
13. Obturator Material	ASTM A105 + Inconel 625 weld overlay (acc. item A.7.1.7.3)		ASTM A105 + Inconel 625 weld overlay (acc. item A.7.1.7.3)		Duplex (UNS S31803)	Duplex (UNS S31803)
14. Seat Material	ASTM A105 + Inconel 625 weld overlay (acc. item A.7.1.7.3)		ASTM B564 (UNS N06625) + Inconel 625 weld overlay (acc. item A.7.1.7.3)		Duplex (UNS S31803)	Duplex (UNS S31803)
15. Spring Material	UNS N07750		UNS N07750		UNS N07750	UNS N07750
16. Shaft Material	ASTM B637 (UNS N07718)		Not Applicable		ASTM A276 (UNS S31803)	ASTM A276 (UNS S31803)
17. Additional Requirement	Fire safe design (acc. item A.6.1.5)		Fire safe design (acc. item A.6.1.5)		Fire safe design (acc. item A.6.1.5)	Fire safe design (acc. item A.6.1.5)
18. Cover Construction	bolted cover		bolted cover		bolted cover	bolted cover
19. Product testing	FAT according A.9.3		FAT according A.9.3		FAT according A.9.3	FAT according A.9.3
20. Cladding or Coating	Full clad - Inconel 625 weld overlay on all wetted parts		Full clad - Inconel 625 weld overlay on all wetted parts		N/A	N/A
21. Notes	N/A		N/A		Wafer valves shall not to be used with flammable services	N/A

Valve Code	VRE-300-2-D235	VRE-300-2-D315		VRE-300-2-D335		VRE-300-2-S212	
Specs	C11	C12		C12		C3	
1. Valve Type	Check, Flanged type	Check, Flanged type		Check, Flanged type		Check, Wafer type	
2. Sealing Type	Metal to Metal	Metal to Metal		Metal to Metal		Metal to Metal	
3. Valve Specification Level (VSL)	VSL-2	VSL-2		VSL-2		VSL-2	
4. Obturator Type	Axial non-slam	Dual Plate		Axial non-slam		Dual Plate	
5. Standard	API 6D	API 594		API 6D		API 594	
6. Size Range (NPS)	2" - 16"	2" - 30"		2" - 30"		2" - 30"	
7. End Connection	ASME B16.5, RF	2" - 24"	ASME B16.5, RF	2" - 24"	ASME B16.5, RF	2" - 24"	ASME B16.5, RF
	N/A	26" - 30"	ASME B16.47 Series A, RF	26" - 30"	ASME B16.47 Series A, RF	26" - 30"	ASME B16.47 Series A, RF
8. Pressure Class	300	300		300		300	
9. Temperature	-46°C to 150°C	-46°C to 150°C		-46°C to 150°C		-46°C to 150°C	
10. Material Class	Duplex Steel	Duplex Steel		Duplex Steel		Stainless Steel	
11. Body Material	ASTM A182 Gr F51 or ASTM A995 Gr 4a	ASTM A182 Gr F55 or ASTM A995 Gr 6a		ASTM A182 Gr F55 or ASTM A995 Gr 6a		ASTM A182 Gr F316 or ASTM A351 Gr CF8M	
12. TRIM Material	N/A	N/A		N/A		TRIM 12 according API 594	
13. Obturator Material	Duplex (UNS S31803)	Super Duplex (UNS S32760)		Super Duplex (UNS S32760)		AISI 316	
14. Seat Material	Duplex (UNS S31803)	Super Duplex (UNS S32760)		Duplex (UNS S31803)		Stellite (Co-Cr Alloy acc. item A.8.2.1.2)	
15. Spring Material	UNS N07750	UNS N07750		UNS N07750		UNS N07750	
16. Shaft Material	Not Applicable	ASTM A276 (UNS S32760)		Not Applicable		ASTM A276 (UNS S31600)	
17. Additional Requirement	Fire safe design (acc. item A.6.1.5)	Fire safe design (acc. item A.6.1.5)		Fire safe design (acc. item A.6.1.5)		Fire safe design (acc. item A.6.1.5)	
18. Cover Construction	bolted cover	bolted cover		bolted cover		bolted cover	
19. Product testing	FAT according A.9.3	FAT according A.9.3		FAT according A.9.3		FAT according A.9.3	
20. Cladding or Coating	N/A	N/A		N/A		N/A	
21. Notes	N/A	N/A		N/A		Wafer valves shall not to be used with flammable services	

Valve Code	VRE-300-2-S215		VRE-300-2-U332	VRE-300-2-U335	VRE-600-1-C111
Specs	C3		C23	C23	E8 E9 E10
1. Valve Type	Check, Flanged type		Check, Wafer type	Check, Flanged type	Check, Wafer type
2. Sealing Type	Metal to Metal		Metal to Metal	Metal to Metal	Soft
3. Valve Specification Level (VSL)	VSL-2		VSL-2	VSL-2	VSL-1
4. Obturator Type	Dual Plate		Axial non-slam	Axial non-slam	Dual Plate
5. Standard	API 594		API 6D	API 6D	API 594
6. Size Range (NPS)	2" - 30"		2" - 28"	2" - 28"	2" - 4"
7. End Connection	2" - 24"	ASME B16.5, RF	ASME B16.42, RF	ASME B16.42, FF	ASME B16.5, RF
	26" - 30"	ASME B16.47 Series A, RF	N/A	N/A	N/A
8. Pressure Class	300		300	300	600
9. Temperature	-46°C to 150°C		0°C to 75°C	0°C to 75°C	0°C to 150°C
10. Material Class	Stainless Steel		Uncommon Materials	Uncommon Materials	Carbon Steel
11. Body Material	ASTM A182 Gr F316 or ASTM A351 Gr CF8M		ASTM B148 (UNS C95800)	ASTM B148 (UNS C95800)	ASTM A105 or ASTM A216 Gr WCB
12. TRIM Material	TRIM 12 according API 594		N/A	N/A	TRIM 1 according API 594
13. Obturator Material	AISI 316		ASTM B148 (UNS C95800)	ASTM B148 (UNS C95800)	AISI 410
14. Seat Material	Stellite (Co-Cr Alloy acc. item A.8.2.1.2)		ASTM B148 (UNS C95800)	ASTM B148 (UNS C95800)	Group A (acc. item A.7.3.3.1)
15. Spring Material	UNS N07750		UNS N07750	UNS N07750	UNS N07750
16. Shaft Material	ASTM A276 (UNS S31600)		Not Applicable	Not Applicable	ASTM A276 (UNS S41000)
17. Additional Requirement	Fire safe design (acc. item A.6.1.5)		N/A	N/A	N/A
18. Cover Construction	bolted cover		bolted cover	bolted cover	bolted cover
19. Product testing	FAT according A.9.3		FAT according A.9.3	FAT according A.9.3	FAT according A.9.3
20. Cladding or Coating	N/A		N/A	N/A	N/A
21. Notes	N/A		Fato-to-face according API 594	N/A	Wafer valves shall not to be used with flammable services

Valve Code	VRE-600-1-C211	VRE-600-1-D211	VRE-600-1-S211	VRE-600-2-A515
Specs	E6 E19	E16	E3	E32
1. Valve Type	Check, Wafer type	Check, Wafer type	Check, Wafer type	Check, Flanged type
2. Sealing Type	Soft	Soft	Soft	Metal to Metal
3. Valve Specification Level (VSL)	VSL-1	VSL-1	VSL-1	VSL-2
4. Obturator Type	Dual Plate	Dual Plate	Dual Plate	Dual Plate
5. Standard	API 594	API 594	API 594	API 594
6. Size Range (NPS)	2" - 4"	2" - 4"	2" - 4"	2" - 16"
7. End Connection	ASME B16.5, RF	ASME B16.5, RF	ASME B16.5, RF	ASME B16.5, RF
8. Pressure Class	600	600	600	600
9. Temperature	0°C to 150°C	0°C to 150°C	0°C to 150°C	-100°C to 400°C
10. Material Class	Carbon Steel	Duplex Steel	Stainless Steel	Alloy Steel
11. Body Material	ASTM A350 Gr LF2 CL1 or ASTM A352 Gr LCB	ASTM A182 Gr F51 or ASTM A995 Gr 4a	ASTM A182 Gr F316 or ASTM A351 Gr CF8M	ASTM A350 Gr LF3 or ASTM A352 Gr LC3 + Inconel 625 weld overlay (acc. item A.7.1.7.3)
12. TRIM Material	TRIM 10 according API 594	N/A	TRIM 10 according API 594	N/A
13. Obturator Material	AISI 316	Duplex (UNS S31803)	AISI 316	ASTM A350 Gr LF3 + Inconel 625 weld overlay (acc. item A.7.1.7.3)
14. Seat Material	Group A (acc. item A.7.3.3.1)	Group A (acc. item A.7.3.3.1)	Group A (acc. item A.7.3.3.1)	ASTM A350 Gr LF3 + Inconel 625 weld overlay (acc. item A.7.1.7.3)
15. Spring Material	UNS N07750	UNS N07750	UNS N07750	UNS N07750
16. Shaft Material	ASTM A276 (UNS S31600)	ASTM A276 (UNS S31803)	ASTM A276 (UNS S31600)	ASTM B637 (UNS N07718)
17. Additional Requirement	N/A	N/A	N/A	Fire safe design (acc. item A.6.1.5)
18. Cover Construction	bolted cover	bolted cover	bolted cover	bolted cover
19. Product testing	FAT according A.9.3	FAT according A.9.3	FAT according A.9.3	FAT according A.9.3
20. Cladding or Coating	N/A	N/A	N/A	Full clad - Inconel 625 weld overlay on all wetted parts
21. Notes	Wafer valves shall not to be used with flammable services	Wafer valves shall not to be used with flammable services	Wafer valves shall not to be used with flammable services	N/A

Valve Code	VRE-600-2-A535	VRE-600-2-C112	VRE-600-2-C113	VRE-600-2-C115
Specs	E32	E8 E9 E10	E10	E9
1. Valve Type	Check, Flanged type	Check, Wafer type	Check, Wafer type	Check, Flanged type
2. Sealing Type	Metal to Metal	Metal to Metal	Metal to Metal	Metal to Metal
3. Valve Specification Level (VSL)	VSL-2	VSL-2	VSL-2	VSL-2
4. Obturator Type	Axial non-slam	Dual Plate	Dual Plate	Dual Plate
5. Standard	API 594	API 594	API 594	API 594
6. Size Range (NPS)	2" - 16"	2" - 24"	2" - 24"	2" - 24"
7. End Connection	ASME B16.5, RF	ASME B16.5, RF	ASME B16.5, RF	ASME B16.5, RF
8. Pressure Class	600	600	600	600
9. Temperature	-100°C to 400°C	-29°C to 400°C	-29°C to 400°C	-29°C to 400°C
10. Material Class	Alloy Steel	Carbon Steel	Carbon Steel	Carbon Steel
11. Body Material	ASTM A350 Gr LF3 or ASTM A352 Gr LC3 + Inconel 625 weld overlay (acc. item A.7.1.7.3)	ASTM A105 or ASTM A216 Gr WCB	ASTM A105 or ASTM A216 Gr WCB	ASTM A105 or ASTM A216 Gr WCB
12. TRIM Material	N/A	TRIM 8 according API 594	TRIM 5 according API 594	TRIM 8 according API 594
13. Obturator Material	ASTM A350 Gr LF3 + Inconel 625 weld overlay (acc. item A.7.1.7.3)	AISI 410	Stellite (Co-Cr Alloy acc. item A.8.2.1.2)	AISI 410
14. Seat Material	ASTM A350 Gr LF3 + Inconel 625 weld overlay (acc. item A.7.1.7.3)	Stellite (Co-Cr Alloy acc. item A.8.2.1.2)	Stellite (Co-Cr Alloy acc. item A.8.2.1.2)	Stellite (Co-Cr Alloy acc. item A.8.2.1.2)
15. Spring Material	UNS N07750	UNS N07750	UNS N07750	UNS N07750
16. Shaft Material	Not Applicable	ASTM A276 (UNS S41000)	ASTM A276 (UNS S41000)	ASTM A276 (UNS S41000)
17. Additional Requirement	Fire safe design (acc. item A.6.1.5)	Fire safe design (acc. item A.6.1.5)	Fire safe design (acc. item A.6.1.5)	Fire safe design (acc. item A.6.1.5)
18. Cover Construction	bolted cover	bolted cover	bolted cover	bolted cover
19. Product testing	FAT according A.9.3	FAT according A.9.3	FAT according A.9.3	FAT according A.9.3
20. Cladding or Coating	Full clad - Inconel 625 weld overlay on all wetted parts	N/A	N/A	N/A
21. Notes	N/A	Wafer valves shall not to be used with flammable services	Wafer valves shall not to be used with flammable services	N/A

Valve Code	VRE-600-2-C135	VRE-600-2-C212	VRE-600-2-C215	VRE-600-2-C235
Specs	E9 E10	E6 E19	E6 E19	E6 E19
1. Valve Type	Check, Flanged type	Check, Wafer type	Check, Flanged type	Check, Flanged type
2. Sealing Type	Metal to Metal	Metal to Metal	Metal to Metal	Metal to Metal
3. Valve Specification Level (VSL)	VSL-2	VSL-2	VSL-2	VSL-2
4. Obturator Type	Axial non-slam	Dual Plate	Dual Plate	Axial non-slam
5. Standard	API 6D	API 594	API 594	API 6D
6. Size Range (NPS)	2" - 24"	2" - 24"	2" - 24"	2" - 24"
7. End Connection	ASME B16.5, RF	ASME B16.5, RF	ASME B16.5, RF	ASME B16.5, RF
8. Pressure Class	600	600	600	600
9. Temperature	-29°C to 210°C	-46°C to 345°C	-46°C to 345°C	-46°C to 210°C
10. Material Class	Carbon Steel	Carbon Steel	Carbon Steel	Carbon Steel
11. Body Material	ASTM A105 or ASTM A216 Gr WCB	ASTM A350 Gr LF2 CL1 or ASTM A352 Gr LCB	ASTM A350 Gr LF2 CL1 or ASTM A352 Gr LCB	ASTM A350 Gr LF2 CL1 or ASTM A352 Gr LCB
12. TRIM Material	N/A	TRIM 12 according API 594	TRIM 12 according API 594	N/A
13. Obturator Material	AISI 410	AISI 316	AISI 316	AISI 316
14. Seat Material	AISI 410	Stellite (Co-Cr Alloy acc. item A.8.2.1.2)	Stellite (Co-Cr Alloy acc. item A.8.2.1.2)	AISI 316
15. Spring Material	UNS N07750	UNS N07750	UNS N07750	UNS N07750
16. Shaft Material	Not Applicable	ASTM A276 (UNS S31600)	ASTM A276 (UNS S31600)	Not Applicable
17. Additional Requirement	Fire safe design (acc. item A.6.1.5)	Fire safe design (acc. item A.6.1.5)	Fire safe design (acc. item A.6.1.5)	Fire safe design (acc. item A.6.1.5)
18. Cover Construction	bolted cover	bolted cover	bolted cover	bolted cover
19. Product testing	FAT according A.9.3	FAT according A.9.3	FAT according A.9.3	FAT according A.9.3
20. Cladding or Coating	N/A	N/A	N/A	N/A
21. Notes	N/A	Wafer valves shall not to be used with flammable services	N/A	N/A

Valve Code	VRE-600-2-C515	VRE-600-2-D212	VRE-600-2-D215	VRE-600-2-D235
Specs	E30	E16	E16	E16
1. Valve Type	Check, Flanged type	Check, Wafer type	Check, Flanged type	Check, Flanged type
2. Sealing Type	Metal to Metal	Metal to Metal	Metal to Metal	Metal to Metal
3. Valve Specification Level (VSL)	VSL-2	VSL-2	VSL-2	VSL-2
4. Obturator Type	Dual Plate	Dual Plate	Dual Plate	Axial non-slam
5. Standard	API 594	API 594	API 594	API 6D
6. Size Range (NPS)	2" - 20"	2" - 16"	2" - 16"	4" - 12"
7. End Connection	ASME B16.5, RF	ASME B16.5, RF	ASME B16.5, RF	ASME B16.5, RF
8. Pressure Class	600	600	600	600
9. Temperature	-29°C to 400°C	-46°C to 150°C	-46°C to 150°C	-46°C to 150°C
10. Material Class	Carbon Steel	Duplex Steel	Duplex Steel	Duplex Steel
11. Body Material	ASTM A105 or ASTM A216 Gr WCB + Inconel 625 weld overlay (acc. item A.7.1.7.3)	ASTM A182 Gr F51 or ASTM A995 Gr 4a	ASTM A182 Gr F51 or ASTM A995 Gr 4a	ASTM A182 Gr F51 or ASTM A995 Gr 4a
12. TRIM Material	N/A	N/A	N/A	N/A
13. Obturator Material	ASTM A105 + Inconel 625 weld overlay (acc. item A.7.1.7.3)	Duplex (UNS S31803)	Duplex (UNS S31803)	Duplex (UNS S31803)
14. Seat Material	ASTM A105 + Inconel 625 weld overlay (acc. item A.7.1.7.3)	Duplex (UNS S31803)	Duplex (UNS S31803)	Duplex (UNS S31803)
15. Spring Material	UNS N07750	UNS N07750	UNS N07750	UNS N07750
16. Shaft Material	ASTM B637 (UNS N07718)	ASTM A276 (UNS S31803)	ASTM A276 (UNS S31803)	Not Applicable
17. Additional Requirement	Fire safe design (acc. item A.6.1.5)	Fire safe design (acc. item A.6.1.5)	Fire safe design (acc. item A.6.1.5)	Fire safe design (acc. item A.6.1.5)
18. Cover Construction	bolted cover	bolted cover	bolted cover	bolted cover
19. Product testing	FAT according A.9.3	FAT according A.9.3	FAT according A.9.3	FAT according A.9.3
20. Cladding or Coating	Full clad - Inconel 625 weld overlay on all wetted parts	N/A	N/A	N/A
21. Notes	N/A	Wafer valves shall not to be used with flammable services	N/A	N/A

Valve Code	VRE-600-2-S212	VRE-600-2-S215	VRE-600-2-S235	VRE-800-1-C102
Specs	E3	E3	E3	C8 E8 R9B R9C
1. Valve Type	Check, Wafer type	Check, Flanged type	Check, Flanged type	Check
2. Sealing Type	Metal to Metal	Metal to Metal	Metal to Metal	Metal to Metal
3. Valve Specification Level (VSL)	VSL-2	VSL-2	VSL-2	VSL-1
4. Obturator Type	Dual Plate	Dual Plate	Axial non-slam	Piston
5. Standard	API 594	API 594	API 6D	API 602
6. Size Range (NPS)	2" - 24"	2" - 24"	2" - 24"	½" - 1 ½"
7. End Connection	ASME B16.5, RF	ASME B16.5, RF	ASME B16.5, RF	N/A
8. Pressure Class	600	600	600	800
9. Temperature	-100°C to 400°C	-100°C to 400°C	-46°C to 200°C	-29°C to 400°C
10. Material Class	Stainless Steel	Stainless Steel	Stainless Steel	Carbon Steel
11. Body Material	ASTM A182 Gr F316 or ASTM A351 Gr CF8M	ASTM A182 Gr F316 or ASTM A351 Gr CF8M	ASTM A182 Gr F316 or ASTM A351 Gr CF8M	ASTM A105
12. TRIM Material	TRIM 12 according API 594	TRIM 12 according API 594	N/A	TRIM 8 according API 594
13. Obturator Material	AISI 316	AISI 316	AISI 316	AISI 410
14. Seat Material	Stellite (Co-Cr Alloy acc. item A.8.2.1.2)	Stellite (Co-Cr Alloy acc. item A.8.2.1.2)	AISI 316	Stellite (Co-Cr Alloy acc. item A.8.2.1.2)
15. Spring Material	UNS N07750	UNS N07750	UNS N07750	N/A
16. Shaft Material	ASTM A276 (UNS S31600)	ASTM A276 (UNS S31600)	Not Applicable	Not Applicable
17. Additional Requirement	Fire safe design (acc. item A.6.1.5)	Fire safe design (acc. item A.6.1.5)	Fire safe design (acc. item A.6.1.5)	Fire safe design (acc. item A.6.1.5)
18. Cover Construction	bolted cover	bolted cover	bolted cover	bolted cover
19. Product testing	FAT according A.9.3	FAT according A.9.3	FAT according A.9.3	FAT according A.9.3
20. Cladding or Coating	N/A	N/A	N/A	N/A
21. Notes	Wafer valves shall not be used with flammable services	N/A	N/A	N/A

Valve Code	VRE-800-1-C103	VRE-800-1-C202	VRE-800-1-D202	VRE-800-1-D302
Specs	B4 B10 C4 C9 C10 S9B S9C	B6 B19 C6 C19	B16 C16 E16	B12 C12
1. Valve Type	Check	Check	Check	Check
2. Sealing Type	Metal to Metal	Metal to Metal	Metal to Metal	Metal to Metal
3. Valve Specification Level (VSL)	VSL-1	VSL-1	VSL-1	VSL-1
4. Obturator Type	Piston	Piston	Piston	Piston
5. Standard	API 602	API 602	API 602	API 602
6. Size Range (NPS)	½" - 1 ½"	½" - 1 ½"	½" - 1 ½"	½" - 1 ½"
7. End Connection	socket weld ends ASME B16.11	socket weld ends ASME B16.11	socket weld ends ASME B16.11	socket weld ends ASME B16.11
8. Pressure Class	800	800	800	800
9. Temperature	-29°C to 400°C	-46°C to 345°C	-46°C to 150°C	-46°C to 150°C
10. Material Class	Carbon Steel	Carbon Steel	Duplex Steel	Duplex Steel
11. Body Material	ASTM A105	ASTM A350 Gr LF2 CL1	ASTM A182 Gr F51	ASTM A182 Gr F55
12. TRIM Material	TRIM 5 according API 594	N/A	N/A	N/A
13. Obturator Material	Stellite (Co-Cr Alloy acc. item A.8.2.1.2)	AISI 316	Duplex (UNS S31803)	Super Duplex (UNS S32760)
14. Seat Material	Stellite (Co-Cr Alloy acc. item A.8.2.1.2)	Stellite (Co-Cr Alloy acc. item A.8.2.1.2)	Duplex (UNS S31803)	Super Duplex (UNS S32760)
15. Spring Material	N/A	N/A	N/A	N/A
16. Shaft Material	Not Applicable	Not Applicable	Not Applicable	Not Applicable
17. Operator Type	N/A	N/A	N/A	N/A
18. Additional Requirement	Fire safe design (acc. item A.6.1.5)	Fire safe design (acc. item A.6.1.5)	Fire safe design (acc. item A.6.1.5)	Fire safe design (acc. item A.6.1.5)
19. Cover Construction	bolted cover	bolted cover	bolted cover	bolted cover
20. Product testing	FAT according A.9.3	FAT according A.9.3	FAT according A.9.3	FAT according A.9.3
21. Notes	N/A	N/A	N/A	N/A

Valve Code	VRE-800-1-N102	VRE-800-1-S202	VRE-800-2-C103	VRE-800-2-C202
Specs	B30 C30 E32	B3 C3 E3 R3B R3C S3B S3C	B9 B10 C4	B6 B19 C6 C19 E6 E19
1. Valve Type	Check	Check	Check	Check
2. Sealing Type	Metal to Metal	Metal to Metal	Metal to Metal	Metal to Metal
3. Valve Specification Level (VSL)	VSL-1	VSL-1	VSL-2	VSL-2
4. Obturator Type	Piston	Piston	Piston	Piston
5. Standard	API 602	API 602	API 602	API 602
6. Size Range (NPS)	½" - 1 ½"	½" - 1 ½"	½" - 1 ½"	½" - 1 ½"
7. End Connection	socket weld ends ASME B16.11	socket weld ends ASME B16.11	socket weld ends ASME B16.11	socket weld ends ASME B16.11
8. Pressure Class	800	800	800	800
9. Temperature	-100°C to 400°C	-100°C to 400°C	-29°C to 400°C	-46°C to 345°C
10. Material Class	Nickel Alloys	Stainless Steel	Carbon Steel	Carbon Steel
11. Body Material	ASTM B564 (UNS N06625)	ASTM A182 Gr F316/316L	ASTM A105	ASTM A350 Gr LF2 CL1
12. TRIM Material	N/A	N/A	TRIM 5 according API 594	N/A
13. Obturator Material	ASTM B564 (UNS N06625)	AISI 316L	Stellite (Co-Cr Alloy acc. item A.8.2.1.2)	AISI 316
14. Seat Material	ASTM B564 (UNS N06625)	Stellite (Co-Cr Alloy acc. item A.8.2.1.2)	Stellite (Co-Cr Alloy acc. item A.8.2.1.2)	Stellite (Co-Cr Alloy acc. item A.8.2.1.2)
15. Spring Material	N/A	N/A	N/A	N/A
16. Shaft Material	Not Applicable	Not Applicable	Not Applicable	Not Applicable
17. Operator Type	N/A	N/A	N/A	N/A
18. Additional Requirement	Fire safe design (acc. item A.6.1.5)	Fire safe design (acc. item A.6.1.5)	Fire safe design (acc. item A.6.1.5)	Fire safe design (acc. item A.6.1.5)
19. Cover Construction	bolted cover	bolted cover	bolted cover	bolted cover
20. Product testing	FAT according A.9.3	FAT according A.9.3	FAT according A.9.3	FAT according A.9.3
21. Notes	N/A	N/A	N/A	N/A

Valve Code	VRE-800-2-D302	VRE-800-2-N102	VRE-800-2-S202	VRE-900-1-C111
Specs	C12	B30 C30	B3 C3 E3	F10
1. Valve Type	Check	Check	Check	Check
2. Sealing Type	Metal to Metal	Metal to Metal	Metal to Metal	Soft
3. Valve Specification Level (VSL)	VSL-2	VSL-2	VSL-2	VSL-1
4. Obturator Type	Piston	Piston	Piston	Dual Plate
5. Standard	API 602	API 602	API 602	API 594
6. Size Range (NPS)	½" - 1 ½"	½" - 1 ½"	½" - 1 ½"	2" - 4"
7. End Connection	socket weld ends ASME B16.11	socket weld ends ASME B16.11	socket weld ends ASME B16.11	N/A
8. Pressure Class	800	800	800	900
9. Temperature	-46°C to 150°C	-100°C to 400°C	-100°C to 400°C	0°C to 150°C
10. Material Class	Duplex Steel	Nickel Alloys	Stainless Steel	Carbon Steel
11. Body Material	ASTM A182 Gr F55	ASTM B564 (UNS N06625)	ASTM A182 Gr F316/316L	ASTM A105 or ASTM A216 Gr WCB
12. TRIM Material	N/A	N/A	N/A	TRIM 1 according API 594
13. Obturator Material	Super Duplex (UNS S32760)	ASTM B564 (UNS N06625)	AISI 316L	AISI 410
14. Seat Material	Super Duplex (UNS S32760)	ASTM B564 (UNS N06625)	Stellite (Co-Cr Alloy acc. item A.8.2.1.2)	Group A (acc. item A.7.3.3.1)
15. Spring Material	N/A	N/A	N/A	UNS N07750
16. Shaft Material	Not Applicable	Not Applicable	Not Applicable	ASTM A276 (UNS S41000)
17. Operator Type	N/A	N/A	N/A	N/A
18. Additional Requirement	Fire safe design (acc. item A.6.1.5)	Fire safe design (acc. item A.6.1.5)	Fire safe design (acc. item A.6.1.5)	N/A
19. Cover Construction	bolted cover	bolted cover	bolted cover	bolted cover
20. Product testing	FAT according A.9.3	FAT according A.9.3	FAT according A.9.3	FAT according A.9.3
21. Notes	N/A	N/A	N/A	Wafer valves shall not to be used with flammable services

Valve Code	VRE-900-1-S211	VRE-900-2-C112	VRE-900-2-C115	VRE-900-2-C135
Specs	F3	F10	F10	F10
1. Valve Type	Check, Wafer type	Check, Wafer type	Check, Flanged type	Check, Flanged type
2. Sealing Type	Soft	Metal to Metal	Metal to Metal	Metal to Metal
3. Valve Specification Level (VSL)	VSL-1	VSL-2	VSL-2	VSL-2
4. Obturator Type	Dual Plate	Dual Plate	Dual Plate	Axial non-slam
5. Standard	API 594	API 594	API 594	API 6D
6. Size Range (NPS)	2" - 4"	2" - 24"	2" - 24"	2" - 24"
7. End Connection	ASME B16.5, RTJ	ASME B16.5, RTJ	ASME B16.5, RTJ	ASME B16.5, RTJ
8. Pressure Class	900	900	900	900
9. Temperature	0°C to 150°C	-29°C to 200°C	-29°C to 200°C	-29°C to 210°C
10. Material Class	Stainless Steel	Carbon Steel	Carbon Steel	Carbon Steel
11. Body Material	ASTM A182 Gr F316 or ASTM A351 Gr CF8M	ASTM A105 or ASTM A216 Gr WCB	ASTM A105 or ASTM A216 Gr WCB	ASTM A105 or ASTM A216 Gr WCB
12. TRIM Material	TRIM 10 according API 594	TRIM 8 according API 594	TRIM 8 according API 594	N/A
13. Obturator Material	AISI 316	AISI 410	AISI 410	AISI 410
14. Seat Material	Group A (acc. item A.7.3.3.1)	Stellite (Co-Cr Alloy acc. item A.8.2.1.2)	Stellite (Co-Cr Alloy acc. item A.8.2.1.2)	AISI 410
15. Spring Material	UNS N07750	UNS N07750	UNS N07750	UNS N07750
16. Shaft Material	ASTM A276 (UNS S31600)	ASTM A276 (UNS S41000)	ASTM A276 (UNS S41000)	Not Applicable
17. Additional Requirement	N/A	Fire safe design (acc. item A.6.1.5)	Fire safe design (acc. item A.6.1.5)	Fire safe design (acc. item A.6.1.5)
18. Cover Construction	bolted cover	bolted cover	bolted cover	bolted cover
19. Product testing	FAT according A.9.3	FAT according A.9.3	FAT according A.9.3	FAT according A.9.3
20. Cladding or Coating	N/A	N/A	N/A	N/A
21. Notes	Wafer valves shall not to be used with flammable services	Wafer valves shall not to be used with flammable services	N/A	N/A

Valve Code	VRE-900-2-C212	VRE-900-2-C215	VRE-900-2-C235	VRE-900-2-S212
Specs	F6	F6	F6	F3
1. Valve Type	Check, Wafer type	Check, Flanged type	Check, Flanged type	Check, Wafer type
2. Sealing Type	Metal to Metal	Metal to Metal	Metal to Metal	Metal to Metal
3. Valve Specification Level (VSL)	VSL-2	VSL-2	VSL-2	VSL-2
4. Obturator Type	Dual Plate	Dual Plate	Axial non-slam	Dual Plate
5. Standard	API 594	API 594	API 6D	API 594
6. Size Range (NPS)	2" - 16"	2" - 16"	2" - 20"	2" - 18"
7. End Connection	ASME B16.5, RTJ	ASME B16.5, RTJ	ASME B16.5, RTJ	ASME B16.5, RTJ
8. Pressure Class	900	900	900	900
9. Temperature	-46°C to 150°C	-46°C to 340°C	-46°C to 210°C	-100°C to 150°C
10. Material Class	Carbon Steel	Carbon Steel	Carbon Steel	Stainless Steel
11. Body Material	ASTM A350 Gr LF2 CL1 or ASTM A352 Gr LCB	ASTM A350 Gr LF2 CL1 or ASTM A352 Gr LCB	ASTM A350 Gr LF2 CL1 or ASTM A352 Gr LCB	ASTM A182 Gr F316 or ASTM A351 Gr CF8M
12. TRIM Material	TRIM 12 according API 594	TRIM 12 according API 594	N/A	TRIM 12 according API 594
13. Obturator Material	AISI 316	AISI 316	AISI 316	AISI 316
14. Seat Material	Stellite (Co-Cr Alloy acc. item A.8.2.1.2)	Stellite (Co-Cr Alloy acc. item A.8.2.1.2)	AISI 316	Stellite (Co-Cr Alloy acc. item A.8.2.1.2)
15. Spring Material	UNS N07750	UNS N07750	UNS N07750	UNS N07750
16. Shaft Material	ASTM A276 (UNS S31600)	ASTM A276 (UNS S31600)	Not Applicable	ASTM A276 (UNS S31600)
17. Additional Requirement	Fire safe design (acc. item A.6.1.5)	Fire safe design (acc. item A.6.1.5)	Fire safe design (acc. item A.6.1.5)	Fire safe design (acc. item A.6.1.5)
18. Cover Construction	bolted cover	bolted cover	bolted cover	bolted cover
19. Product testing	FAT according A.9.3	FAT according A.9.3	FAT according A.9.3	FAT according A.9.3
20. Cladding or Coating	N/A	N/A	N/A	N/A
21. Notes	Wafer valves shall not to be used with flammable services	N/A	N/A	Wafer valves shall not to be used with flammable services

OFFSHORE PRODUCTION FACILITIES
PIPING SPECIFICATION FOR TOPSIDE

Valve Code	VRE-900-2-S215	VRE-900-2-S235
Specs	F3	F3
1. Valve Type	Check, Flanged type	Check, Flanged type
2. Sealing Type	Metal to Metal	Metal to Metal
3. Valve Specification Level (VSL)	VSL-2	VSL-2
4. Obturator Type	Dual Plate	Axial non-slam
5. Standard	API 594	API 6D
6. Size Range (NPS)	2" - 18"	2" - 18"
7. End Connection	ASME B16.5, RTJ	ASME B16.5, RTJ
8. Pressure Class	900	900
9. Temperature	-100°C to 150°C	-46°C to 150°C
10. Material Class	Stainless Steel	Stainless Steel
11. Body Material	ASTM A182 Gr F316 or ASTM A351 Gr CF8M	ASTM A182 Gr F316 or ASTM A351 Gr CF8M
12. TRIM Material	TRIM 12 according API 594	N/A
13. Obturator Material	AISI 316	AISI 316
14. Seat Material	Stellite (Co-Cr Alloy acc. item A.8.2.1.2)	AISI 316
15. Spring Material	UNS N07750	UNS N07750
16. Shaft Material	ASTM A276 (UNS S31600)	Not Applicable
17. Additional Requirement	Fire safe design (acc. item A.6.1.5)	Fire safe design (acc. item A.6.1.5)
18. Cover Construction	bolted cover	bolted cover
19. Product testing	FAT according A.9.3	FAT according A.9.3
20. Cladding or Coating	N/A	N/A
21. Notes	N/A	N/A

A.12.8 BUTTERFLY VALVES

Valve Code	VBO-150-1-U201		VBO-150-1-U202		VBO-150-1-U203		VBO-150-2-C111	
Specs	B22		B22		B22		B10	
1. Valve Type	Butterfly, Lug type		Butterfly, Wafer type		Butterfly, Double Flanged (short pattern)		Butterfly, Lug type	
2. Sealing Type	Soft		Soft		Soft		Soft	
3. Valve Specification Level (VSL)	VSL-1		VSL-1		VSL-1		VSL-2	
4. Disc & Seat Configuration	Concentric		Concentric		Concentric		Double Offset	
5. Standard	API 609 Category A		API 609 Category A		API 609 Category A		API 609 Category B	
6. Size Range (NPS)	2" - 36"		2" - 36"		6" - 44"		3" - 36"	
7. End Connection	ASME B16.5, FF		ASME B16.5, FF		ASME B16.47, FF		RF	
8. Pressure Class	max. press 150 psig		max. press 150 psig		max. press 150 psig		150	
9. Temperature	0°C to 75°C		0°C to 75°C		0°C to 75°C		-29°C to 150°C	
10. Material Class	Uncommon Materials		Uncommon Materials		Uncommon Materials		Carbon Steel	
11. Body Material	ASTM A536 Gr. 65-45-12		ASTM A536 Gr. 65-45-12		ASTM A536 Gr. 65-45-12		ASTM A105 or ASTM A216 Gr WCB	
12. Disc Material	ASTM B148 (UNS C95800)		ASTM B148 (UNS C95800)		ASTM B148 (UNS C95800)		AISI 410 + ENP (acc. Item A.8.2.1.1)	
13. Seat Material	FKM		FKM		FKM		RPTFE	
14. Seal Ring	N/A		N/A		N/A		N/A	
15. Stem Material	ASTM A276 (UNS S41000)		ASTM A276 (UNS S41000)		ASTM A276 (UNS S41000)		ASTM A276 (UNS S41000)	
16. Stem Seal Material	According manufacturer standard, fitted to service conditions		According manufacturer standard, fitted to service conditions		According manufacturer standard, fitted to service conditions		According manufacturer standard, fitted to service conditions	
17. Operator Type	2" - 8"	Lever	2" - 8"	Lever	6" - 8"	Lever	3" - 6"	Lever
	10" - 36"	Gearbox					10" - 36"	Gearbox
18. Additional Requirement	N/A		N/A		N/A		N/A	
19. Product testing	FAT according A.9.3		FAT according A.9.3		FAT according A.9.3		FAT according A.9.3	
20. Disc Coating	N/A		N/A		N/A		Electroless Nickel Plating (ENP)	
21. Notes	Through holes drilled and tapped acc. to ASME B1.1		Wafer valves shall not to be used with flammable or combustible services		N/A		Through holes drilled and tapped acc. to ASME B1.1	

Valve Code	VBO-150-2-C112		VBO-150-2-C113		VBO-150-2-C213		VBO-150-2-D111	
Specs	B4 B9 B10		B9 B10		B6 B19		B26	
1. Valve Type	Butterfly, Wafer type		Butterfly, Double Flanged (short pattern)		Butterfly, Double Flanged (short pattern)		Butterfly, Lug type	
2. Sealing Type	Soft		Soft		Soft		Soft	
3. Valve Specification Level (VSL)	VSL-2		VSL-2		VSL-2		VSL-2	
4. Disc & Seat Configuration	Double Offset		Double Offset		Double Offset		Double Offset	
5. Standard	API 609 Category B		API 609 Category B		API 609 Category B		API 609 Category B	
6. Size Range (NPS)	3" - 36"		3" - 36"		6" - 32"		6" - 24"	
7. End Connection	3" - 24"	ASME B16.5, RF	3" - 24"	ASME B16.5, RF	6" - 24"	ASME B16.5, RF	ASME B16.5, FF	
	26" - 36"	ASME B16.47 Series A, RF	26" - 36"	ASME B16.47 Series A, RF	26" - 32"	ASME B16.47 Series A, RF	N/A	
8. Pressure Class	150		150		150		150	
9. Temperature	-29°C to 240°C		-29°C to 240°C		-46°C to 240°C		-29°C to 150°C	
10. Material Class	Carbon Steel		Carbon Steel		Carbon Steel		Duplex Steel	
11. Body Material	ASTM A105 or ASTM A216 Gr WCB		ASTM A105 or ASTM A216 Gr WCB		ASTM A350 Gr LF2 CL1 or ASTM A352 Gr LCB		ASTM A995 Gr 1b	
12. Disc Material	AISI 410 + ENP (acc. Item A.8.2.1.1)		AISI 410 + ENP (acc. Item A.8.2.1.1)		AISI 316		ASTM A995 Gr 1b	
13. Seat Material	RPTFE		RPTFE		RPTFE		RPTFE	
14. Seal Ring	N/A		N/A		N/A		N/A	
15. Stem Material	ASTM A276 (UNS S41000)		ASTM A276 (UNS S41000)		ASTM A276 (UNS S31600)		ASTM A276 (UNS S32550)	
16. Stem Seal Material	According manufacturer standard, fitted to service conditions		According manufacturer standard, fitted to service conditions		According manufacturer standard, fitted to service conditions		According manufacturer standard, fitted to service conditions	
17. Operator Type	3" - 6"	Lever	3" - 6"	Lever	6"	Lever	6"	Lever
	8" - 36"	Gearbox	8" - 36"	Gearbox	8" - 32"	Gearbox	8" - 24"	Gearbox
18. Additional Requirement	N/A		N/A		N/A		N/A	
19. Product testing	FAT according A.9.3		FAT according A.9.3		FAT according A.9.3		FAT according A.9.3	
20. Disc Coating	Electroless Nickel Plating (ENP)		Electroless Nickel Plating (ENP)		N/A		N/A	
21. Notes	Wafer valves shall not be used with flammable or combustible services		N/A		N/A		Through holes drilled and tapped acc. to ASME B1.1	

Valve Code	VBO-150-2-D113		VBO-150-2-D211		VBO-150-2-D212		VBO-150-2-D213	
Specs	B26		B11 B16		B11		B11 B16	
1. Valve Type	Butterfly, Double Flanged (short pattern)		Butterfly, Lug type		Butterfly, Wafer type		Butterfly, Double Flanged (short pattern)	
2. Sealing Type	Soft		Soft		Soft		Soft	
3. Valve Specification Level (VSL)	VSL-2		VSL-2		VSL-2		VSL-2	
4. Disc & Seat Configuration	Double Offset		Double Offset		Double Offset		Double Offset	
5. Standard	API 609 Category B		API 609 Category B		API 609 Category B		API 609 Category B	
6. Size Range (NPS)	10" - 28"		3" - 32"		3" - 36"		3" - 32"	
7. End Connection	10" - 24"	ASME B16.5, FF	3" - 24"	ASME B16.5, RF	3" - 24"	ASME B16.5, RF	3" - 24"	ASME B16.5, RF
	26" - 28"	ASME B16.47 Series A, FF	26" - 32"	ASME B16.47 Series A, RF	26" - 36"	ASME B16.47 Series A, RF	26" - 32"	ASME B16.47 Series A, RF
8. Pressure Class	150		150		150		150	
9. Temperature	-29°C to 150°C		-46°C to 150°C		-46°C to 150°C		-46°C to 200°C	
10. Material Class	Duplex Steel		Duplex Steel		Duplex Steel		Duplex Steel	
11. Body Material	ASTM A995 Gr 1b		ASTM A182 Gr F51 or ASTM A995 Gr 4a		ASTM A182 Gr F51 or ASTM A995 Gr 4a		ASTM A182 Gr F51 or ASTM A995 Gr 4a	
12. Disc Material	ASTM A995 Gr 1b		Duplex (UNS S31803)		Duplex (UNS S31803)		Duplex (UNS S31803)	
13. Seat Material	RPTFE		RPTFE		RPTFE		RPTFE	
14. Seal Ring	N/A		N/A		N/A		N/A	
15. Stem Material	ASTM A276 (UNS S32550)		ASTM A276 (UNS S31803)		ASTM A276 (UNS S31803)		ASTM A276 (UNS S31803)	
16. Stem Seal Material	According manufacturer standard, fitted to service conditions		According manufacturer standard, fitted to service conditions		According manufacturer standard, fitted to service conditions		According manufacturer standard, fitted to service conditions	
17. Operator Type	Gearbox		3" - 6"	Lever	3" - 6"	Lever	3" - 6"	Lever
	N/A		8" - 32"	Gearbox	8" - 36"	Gearbox	8" - 32"	Gearbox
18. Additional Requirement	N/A		N/A		N/A		N/A	
19. Product testing	FAT according A.9.3		FAT according A.9.3		FAT according A.9.3		FAT according A.9.3	
20. Disc Coating	N/A		N/A		N/A		N/A	
21. Notes	N/A		Through holes drilled and tapped acc. to ASME B1.1		Wafer valves shall not to be used with flammable or combustibile services		N/A	

Valve Code	VBO-150-2-D311		VBO-150-2-D313		VBO-150-2-S211		VBO-150-2-S212	
Specs	B12		B12		B3		B3	
1. Valve Type	Butterfly, Lug type		Butterfly, Double Flanged (short pattern)		Butterfly, Lug type		Butterfly, Wafer type	
2. Sealing Type	Soft		Soft		Soft		Soft	
3. Valve Specification Level (VSL)	VSL-2		VSL-2		VSL-2		VSL-2	
4. Disc & Seat Configuration	Double Offset		Double Offset		Double Offset		Double Offset	
5. Standard	API 609 Category B		API 609 Category B		API 609 Category B		API 609 Category B	
6. Size Range (NPS)	6" - 24"		10" - 36"		3" - 30"		3" - 30"	
7. End Connection	ASME B16.5, RF		10" - 24"	ASME B16.5, RF	3" - 24"	ASME B16.5, RF	3" - 24"	ASME B16.5, RF
	N/A		26" - 36"	ASME B16.47 Series A, RF	26" - 30"	ASME B16.47 Series A, RF	26" - 30"	ASME B16.47 Series A, RF
8. Pressure Class	150		150		150		150	
9. Temperature	0°C to 150°C		0°C to 150°C		-46°C to 150°C		-46°C to 150°C	
10. Material Class	Duplex Steel		Duplex Steel		Stainless Steel		Stainless Steel	
11. Body Material	ASTM A182 Gr F55 or ASTM A995 Gr 6a		ASTM A182 Gr F55 or ASTM A995 Gr 6a		ASTM A182 Gr F316 or ASTM A351 Gr CF8M		ASTM A182 Gr F316 or ASTM A351 Gr CF8M	
12. Disc Material	Super Duplex (UNS S32760)		Super Duplex (UNS S32760)		AISI 316		AISI 316	
13. Seat Material	RPTFE		RPTFE		RPTFE		RPTFE	
14. Seal Ring	N/A		N/A		N/A		N/A	
15. Stem Material	ASTM A276 (UNS S32760)		ASTM A276 (UNS S32760)		ASTM A564 Type 630 H1150 (UNS S17400)		ASTM A564 Type 630 H1150 (UNS S17400)	
16. Stem Seal Material	According manufacturer standard, fitted to service conditions		According manufacturer standard, fitted to service conditions		According manufacturer standard, fitted to service conditions		According manufacturer standard, fitted to service conditions	
17. Operator Type	6"	Lever	Gearbox		3" - 6"	Lever	3" - 6"	Lever
	8" - 24"	Gearbox	N/A		8" - 30"	Gearbox	8" - 30"	Gearbox
18. Additional Requirement	N/A		N/A		N/A		N/A	
19. Product testing	FAT according A.9.3		FAT according A.9.3		FAT according A.9.3		FAT according A.9.3	
20. Disc Coating	N/A		N/A		N/A		N/A	
21. Notes	Through holes drilled and tapped acc. to ASME B1.1		N/A		Through holes drilled and tapped acc. to ASME B1.1		Wafer valves shall not to be used with flammable or combustible services	

Valve Code	VBO-150-2-S213		VBO-150-2-S216		VBO-150-2-U311		VBO-150-2-U312	
Specs	B3		B3		B7R B7 B23		B7R B7 B22 B23	
1. Valve Type	Butterfly, Double Flanged (short pattern)		Butterfly, Double Flanged (short pattern)		Butterfly, Lug type		Butterfly, Wafer type	
2. Sealing Type	Soft		Soft		Soft		Soft	
3. Valve Specification Level (VSL)	VSL-2		VSL-2		VSL-2		VSL-2	
4. Disc & Seat Configuration	Double Offset		Double Offset		Double Offset		Double Offset	
5. Standard	API 609 Category B		API 609 Category B		API 609 Category B		API 609 Category B	
6. Size Range (NPS)	3" - 36"		6" - 30"		3" - 44"		6" - 44"	
7. End Connection	3" - 24"	ASME B16.5, RF	6" - 24"	ASME B16.5, RF	3" - 24"	ASME B16.5, RF	6" - 24"	ASME B16.5, RF
	26" - 36"	ASME B16.47 Series A, RF	26" - 30"	ASME B16.47 Series A, RF	26" - 44"	ASME B16.47 Series A, RF	26" - 44"	ASME B16.47 Series A, RF
8. Pressure Class	150		150		150		150	
9. Temperature	-46°C to 150°C		-100°C to 150°C		-46°C to 75°C		-46°C to 75°C	
10. Material Class	Stainless Steel		Stainless Steel		Uncommon Materials		Uncommon Materials	
11. Body Material	ASTM A182 Gr F316 or ASTM A351 Gr CF8M		ASTM A182 Gr F316 or ASTM A351 Gr CF8M		ASTM B148 (UNS C95800)		ASTM B148 (UNS C95800)	
12. Disc Material	AISI 316		AISI 316		ASTM B148 (UNS C95800)		ASTM B148 (UNS C95800)	
13. Seat Material	RPTFE		According to manufacturer		RPTFE		RPTFE	
14. Seal Ring	N/A		N/A		N/A		N/A	
15. Stem Material	ASTM A564 Type 630 H1150 (UNS S17400)		ASTM A276 (UNS S31600)		ASTM B574 (UNS N10276)		ASTM B574 (UNS N10276)	
16. Stem Seal Material	According manufacturer standard, fitted to service conditions		According manufacturer standard, fitted to service conditions		PTFE		PTFE	
17. Operator Type	3" - 6"	Lever	6"	Lever	3" - 6"	Lever	6"	Lever
	8" - 36"	Gearbox	8" - 30"	Gearbox	8" - 44"	Gearbox	8" - 44"	Gearbox
18. Additional Requirement	N/A		N/A		N/A		N/A	
19. Product testing	FAT according A.9.3		FAT according A.9.3		FAT according A.9.3		FAT according A.9.3	
20. Disc Coating	N/A		N/A		N/A		N/A	
21. Notes	N/A		N/A		Through holes drilled and tapped acc. to ASME B1.1		Wafer valves shall not to be used with flammable or combustible services	

Valve Code	VBO-150-2-U313		VBO-150-2-U314		VBO-150-2-U315		VBO-150-2-U316	
Specs	B7R B7 B23		B14 B22		B14		B14 B22	
1. Valve Type	Butterfly, Double Flanged (short pattern)		Butterfly, Lug type		Butterfly, Wafer type		Butterfly, Double Flanged (short pattern)	
2. Sealing Type	Soft		Soft		Soft		Soft	
3. Valve Specification Level (VSL)	VSL-2		VSL-2		VSL-2		VSL-2	
4. Disc & Seat Configuration	Double Offset		Double Offset		Double Offset		Double Offset	
5. Standard	API 609 Category B		API 609 Category B		API 609 Category B		API 609 Category B	
6. Size Range (NPS)	3" - 44"		3" - 44"		3" - 44"		3" - 48"	
7. End Connection	3" - 24"	ASME B16.5, RF	3" - 24"	ASME B16.5, FF	3" - 24"	ASME B16.5, FF	3" - 24"	ASME B16.5, FF
	26" - 44"	ASME B16.47 Series A, RF	26" - 44"	ASME B16.47 Series A, FF	26" - 44"	ASME B16.47 Series A, FF	26" - 48"	ASME B16.47 Series A, FF
8. Pressure Class	150		150		150		150	
9. Temperature	0°C to 90°C		0°C to 90°C		0°C to 90°C		0°C to 90°C	
10. Material Class	Uncommon Materials		Uncommon Materials		Uncommon Materials		Uncommon Materials	
11. Body Material	ASTM B148 (UNS C95800)		ASTM B148 (UNS C95800)		ASTM B148 (UNS C95800)		ASTM B148 (UNS C95800)	
12. Disc Material	ASTM B148 (UNS C95800)		ASTM B148 (UNS C95800)		ASTM B148 (UNS C95800)		ASTM B148 (UNS C95800)	
13. Seat Material	RPTFE		RPTFE		RPTFE		RPTFE	
14. Seal Ring	N/A		N/A		N/A		N/A	
15. Stem Material	ASTM B574 (UNS N10276)		ASTM B574 (UNS N10276)		ASTM B574 (UNS N10276)		ASTM B574 (UNS N10276)	
16. Stem Seal Material	PTFE		PTFE		PTFE		PTFE	
17. Operator Type	3" - 6"	Lever	3" - 6"	Lever	3" - 6"	Lever	3" - 6"	Lever
	8" - 44"	Gearbox	8" - 44"	Gearbox	8" - 44"	Gearbox	8" - 48"	Gearbox
18. Additional Requirement	N/A		N/A		N/A		N/A	
19. Product testing	FAT according A.9.3		FAT according A.9.3		FAT according A.9.3		FAT according A.9.3	
20. Disc Coating	N/A		N/A		N/A		N/A	
21. Notes	N/A		Through holes drilled and tapped acc. to ASME B1.1		Wafer valves shall not to be used with flammable or combustible services		N/A	

Valve Code	VBO-150-2-U317		VBO-150-2-U318		VBO-150-2-U319		VBO-150-3-C123	
Specs	B7R B7		B7R B7		B7R B7		B4 B9 B10	
1. Valve Type	Butterfly, Lug type		Butterfly, Wafer type		Butterfly, Double Flanged (short pattern)		Butterfly, Double Flanged (short pattern)	
2. Sealing Type	Soft		Soft		Soft		Metal to Metal	
3. Valve Specification Level (VSL)	VSL-2		VSL-2		VSL-2		VSL-3	
4. Disc & Seat Configuration	Double Offset		Double Offset		Double Offset		Triple Offset	
5. Standard	API 609 Category B		API 609 Category B		API 609 Category B		API 609 Category B	
6. Size Range (NPS)	3" - 36"		3" - 36"		3" - 36"		3" - 36"	
7. End Connection	3" - 24"	ASME B16.5, RF	3" - 24"	ASME B16.5, RF	3" - 24"	ASME B16.5, RF	3" - 24"	ASME B16.5, RF
	26" - 36"	ASME B16.47 Series A, RF	26" - 36"	ASME B16.47 Series A, RF	26" - 36"	ASME B16.47 Series A, RF	26" - 36"	ASME B16.47 Series A, RF
8. Pressure Class	150		150		150		150	
9. Temperature	-46°C to 75°C		-46°C to 75°C		0°C to 90°C		-29°C to 240°C	
10. Material Class	Uncommon Materials		Uncommon Materials		Uncommon Materials		Carbon Steel	
11. Body Material	ASTM B148 (UNS C95800)		ASTM B148 (UNS C95800)		ASTM B148 (UNS C95800)		ASTM A105	
12. Disc Material	ASTM B148 (UNS C95800)		ASTM B148 (UNS C95800)		ASTM B148 (UNS C95800)		AISI 316	
13. Seat Material	RPTFE		RPTFE		RPTFE		AISI 316 + Metallic Coating (acc. Item A.7.5.4.3.2)	
14. Seal Ring	N/A		N/A		N/A		Graphite Laminated with AISI 316	
15. Stem Material	ASTM B574 (UNS N10276)		ASTM B574 (UNS N10276)		ASTM B574 (UNS N10276)		ASTM A564 Type 630 H1150 (UNS S17400)	
16. Stem Seal Material	PTFE		PTFE		PTFE		Graphite Based Seal	
17. Operator Type	3" - 6"	Lever	3" - 6"	Lever	3" - 6"	Lever	N/A	
	8" - 36"	Gearbox	8" - 36"	Gearbox	8" - 36"	Gearbox	N/A	
18. Additional Requirement	Fire Tested (acc. item A.6.1.4)		Fire Tested (acc. item A.6.1.4)		Fire Tested (acc. item A.6.1.4)		Fire Tested (acc. item A.6.1.4)	
19. Product testing	FAT according A.9.3		FAT according A.9.3		FAT according A.9.3		FAT according A.9.3	
20. Disc Coating	N/A		N/A		N/A		N/A	
21. Notes	Through holes drilled and tapped acc. to ASME B1.1		Wafer valves shall not to be used with flammable or combustible services		N/A		Acceptance criteria for all HP/LP seat tests (Normative/Supplementary): ISO 5208 Rate A	

Valve Code	VBO-150-3-C223		VBO-150-3-D223		VBO-150-3-D323		VBO-150-3-S223	
Specs	B6 B19		B11 B16		B12		B3	
1. Valve Type	Butterfly, Double Flanged (short pattern)		Butterfly, Double Flanged (short pattern)		Butterfly, Double Flanged (short pattern)		Butterfly, Double Flanged (short pattern)	
2. Sealing Type	Metal to Metal		Metal to Metal		Metal to Metal		Metal to Metal	
3. Valve Specification Level (VSL)	VSL-3		VSL-3		VSL-3		VSL-3	
4. Disc & Seat Configuration	Triple Offset		Triple Offset		Triple Offset		Triple Offset	
5. Standard	API 609 Category B		API 609 Category B		API 609 Category B		API 609 Category B	
6. Size Range (NPS)	10" - 36"		3" - 36"		10" - 36"		3" - 30"	
7. End Connection	10" - 24"	ASME B16.5, RF	3" - 24"	ASME B16.5, RF	10" - 24"	ASME B16.5, RF	3" - 24"	ASME B16.5, RF
	26" - 36"	ASME B16.47 Series A, RF	26" - 36"	ASME B16.47 Series A, RF	26" - 36"	ASME B16.47 Series A, RF	26" - 30"	ASME B16.47 Series A, RF
8. Pressure Class	150		150		150		150	
9. Temperature	-46°C to 240°C		-46°C to 150°C		-46°C to 150°C		-100°C to 345°C	
10. Material Class	Carbon Steel		Duplex Steel		Duplex Steel		Stainless Steel	
11. Body Material	ASTM A350 Gr LF2 CL1		ASTM A182 Gr F51		ASTM A182 Gr F55		ASTM A182 Gr F316	
12. Disc Material	AISI 316		Duplex (UNS S31803)		Super Duplex (UNS S32760)		AISI 316	
13. Seat Material	AISI 316 + Metallic Coating (acc. Item A.7.5.4.3.2)		Duplex (UNS S31803) + Metallic Coating (acc. Item A.7.5.4.3.2)		Super Duplex (UNS S32760) + Metallic Coating (acc. Item A.7.5.4.3.2)		AISI 316 + Metallic Coating (acc. Item A.7.5.4.3.2)	
14. Seal Ring	Graphite Laminated with AISI 316		Graphite Laminated with Duplex (UNS S31803)		Graphite Laminated with Super Duplex (UNS S32760)		Graphite Laminated with AISI 316	
15. Stem Material	ASTM A564 Type 630 H1150 (UNS S17400)		ASTM A276 (UNS S31803)		ASTM A276 (UNS S32760)		ASTM A276 (UNS S31600)	
16. Stem Seal Material	Graphite Based Seal		Graphite Based Seal		Graphite Based Seal		Graphite Based Seal	
17. Operator Type	Gearbox		Gearbox		Gearbox		Gearbox	
18. Additional Requirement	Fire Tested (acc. item A.6.1.4)		Fire Tested (acc. item A.6.1.4)		Fire Tested (acc. item A.6.1.4)		Fire Tested (acc. item A.6.1.4)	
19. Product testing	FAT according A.9.3		FAT according A.9.3		FAT according A.9.3		FAT according A.9.3	
20. Disc Coating	N/A		N/A		N/A		N/A	
21. Notes	Acceptance criteria for all HP/LP seat tests (Normative/Supplementary): ISO 5208 Rate A		Acceptance criteria for all HP/LP seat tests (Normative/Supplementary): ISO 5208 Rate A		Acceptance criteria for all HP/LP seat tests (Normative/Supplementary): ISO 5208 Rate A		Acceptance criteria for all HP/LP seat tests (Normative/Supplementary): ISO 5208 Rate A	

Valve Code	VBO-150-3-U323		VBO-150-3-U326		VBO-250-1-U201	VBO-250-1-U202
Specs	B7R B7		B14 B22 B23		B14 B23	B14
1. Valve Type	Butterfly, Double Flanged (short pattern)		Butterfly, Double Flanged (short pattern)		Butterfly, Lug type	Butterfly, Wafer type
2. Sealing Type	Metal to Metal		Metal to Metal		Soft	Soft
3. Valve Specification Level (VSL)	VSL-3		VSL-3		VSL-1	VSL-1
4. Disc & Seat Configuration	Triple Offset		Triple Offset		Concentric	Concentric
5. Standard	API 609 Category B		API 609 Category B		API 609 Category A	API 609 Category A
6. Size Range (NPS)	3" - 36"		3" - 38"		2" - 36"	2" - 24"
7. End Connection	3" - 24"	ASME B16.5, RF	3" - 24"	ASME B16.5, FF	FF	FF
	26" - 36"	ASME B16.47 Series A, RF	26" - 38"	ASME B16.47 Series A, FF	N/A	N/A
8. Pressure Class	150		150		max. press 250 psig	max. press 250 psig
9. Temperature	-29°C to 75°C		-29°C to 75°C		0°C to 75°C	0°C to 75°C
10. Material Class	Uncommon Materials		Uncommon Materials		Uncommon Materials	Uncommon Materials
11. Body Material	ASTM B148 (UNS C95800)		ASTM B148 (UNS C95800)		ASTM A536 Gr. 65-45-12	ASTM A536 Gr. 65-45-12
12. Disc Material	ASTM B148 (UNS C95800)		ASTM B148 (UNS C95800)		ASTM B148 (UNS C95800)	ASTM B148 (UNS C95800)
13. Seat Material	ASTM B148 (UNS C95800) + Metallic Coating (acc. Item A.7.5.4.3.2)		ASTM B148 (UNS C95800) + Metallic Coating (acc. Item A.7.5.4.3.2)		FKM	FKM
14. Seal Ring	Solid NAB (UNS C95800)		Solid NAB (UNS C95800)		N/A	N/A
15. Stem Material	ASTM B574 (UNS N10276)		ASTM B574 (UNS N10276)		ASTM A276 (UNS S41000)	ASTM A276 (UNS S41000)
16. Stem Seal Material	PTFE		PTFE		According manufacturer standard, fitted to service conditions	According manufacturer standard, fitted to service conditions
17. Operator Type	Gearbox		Gearbox		N/A	N/A
18. Additional Requirement	Fire Tested (acc. item A.6.1.4)		Fire Tested (acc. item A.6.1.4)		N/A	N/A
19. Product testing	FAT according A.9.3		FAT according A.9.3		FAT according A.9.3	FAT according A.9.3
20. Disc Coating	N/A		N/A		N/A	N/A
21. Notes	Acceptance criteria for all HP/LP seat tests (Normative/Supplementary): ISO 5208 Rate A		Acceptance criteria for all HP/LP seat tests (Normative/Supplementary): ISO 5208 Rate A		Through holes drilled and tapped acc. to ASME B1.1	Wafer valves shall not to be used with flammable or combustible services

Valve Code	VBO-250-1-U203		VBO-250-1-U204		VBO-250-1-U205		VBO-250-1-U206	
Specs	B14 B23		B7R B10		B3 B7R B9 B10		B7R B10	
1. Valve Type	Butterfly, Double Flanged (short pattern)		Butterfly, Lug type		Butterfly, Wafer type		Butterfly, Double Flanged (short pattern)	
2. Sealing Type	Soft		Soft		Soft		Soft	
3. Valve Specification Level (VSL)	VSL-1		VSL-1		VSL-1		VSL-1	
4. Disc & Seat Configuration	Concentric		Concentric		Concentric		Concentric	
5. Standard	API 609 Category A		API 609 Category A		API 609 Category A		API 609 Category A	
6. Size Range (NPS)	2" - 46"		2" - 24"		2" - 26"		2" - 36"	
7. End Connection	ASME B16.47, FF		ASME B16.5, RF		ASME B16.5, RF		ASME B16.47, RF	
8. Pressure Class	max. press 250 psig		max. press 250 psig		max. press 250 psig		max. press 250 psig	
9. Temperature	0°C to 75°C		0°C to 75°C		0°C to 75°C		0°C to 75°C	
10. Material Class	Uncommon Materials		Uncommon Materials		Uncommon Materials		Uncommon Materials	
11. Body Material	ASTM A536 Gr. 65-45-12		ASTM A536 Gr. 65-45-12		ASTM A536 Gr. 65-45-12		ASTM A536 Gr. 65-45-12	
12. Disc Material	ASTM B148 (UNS C95800)		ASTM B148 (UNS C95800)		ASTM B148 (UNS C95800)		ASTM B148 (UNS C95800)	
13. Seat Material	FKM		NBR		NBR		NBR	
14. Seal Ring	N/A		N/A		N/A		N/A	
15. Stem Material	ASTM A276 (UNS S41000)		ASTM B150 (UNS C63200)		ASTM B150 (UNS C63200)		ASTM B150 (UNS C63200)	
16. Stem Seal Material	According manufacturer standard, fitted to service conditions		According manufacturer standard, fitted to service conditions		According manufacturer standard, fitted to service conditions		According manufacturer standard, fitted to service conditions	
17. Operator Type	2" - 8"	Lever	2" - 8"	Lever	2" - 8"	Lever	2" - 8"	Lever
	10" - 46"	Gearbox	10" - 24"	Gearbox	10" - 26"	Gearbox	10" - 36"	Gearbox
18. Additional Requirement	N/A		N/A		N/A		N/A	
19. Product testing	FAT according A.9.3		FAT according A.9.3		FAT according A.9.3		FAT according A.9.3	
20. Disc Coating	N/A		N/A		N/A		N/A	
21. Notes	N/A		Through holes drilled and tapped acc. to ASME B1.1		Wafer valves shall not to be used with flammable or combustible services		N/A	

Valve Code	VBO-250-1-U207		VBO-250-1-U208		VBO-250-1-U209		VBO-300-1-U311	
Specs	B11		B11		B11		C23	
1. Valve Type	Butterfly, Lug type		Butterfly, Wafer type		Butterfly, Double Flanged (short pattern)		Butterfly, Lug type	
2. Sealing Type	Soft		Soft		Soft		Soft	
3. Valve Specification Level (VSL)	VSL-1		VSL-1		VSL-1		VSL-1	
4. Disc & Seat Configuration	Concentric		Concentric		Concentric		Double Offset	
5. Standard	API 609 Category A		API 609 Category A		API 609 Category A		API 609 Category B	
6. Size Range (NPS)	2" - 24"		2" - 24"		2" - 36"		6" - 28"	
7. End Connection	ASME B16.5, RF		ASME B16.5, RF		ASME B16.47, RF		RF	
8. Pressure Class	max. press 250 psig		max. press 250 psig		max. press 250 psig		300	
9. Temperature	0°C to 80°C		0°C to 80°C		0°C to 80°C		0°C to 75°C	
10. Material Class	Uncommon Materials		Uncommon Materials		Uncommon Materials		Uncommon Materials	
11. Body Material	ASTM A536 Gr. 65-45-12		ASTM A536 Gr. 65-45-12		ASTM A536 Gr. 65-45-12		ASTM B148 (UNS C95800)	
12. Disc Material	ASTM A536 Gr 65-45-12 + Polyamide Disc Coating (acc. item A.8.2.3.2)		ASTM A536 Gr 65-45-12 + Polyamide Disc Coating (acc. item A.8.2.3.2)		ASTM A536 Gr 65-45-12 + Polyamide Disc Coating (acc. item A.8.2.3.2)		ASTM B148 (UNS C95800)	
13. Seat Material	NBR		NBR		NBR		RPTFE	
14. Seal Ring	N/A		N/A		N/A		N/A	
15. Stem Material	ASTM A276 (UNS S31803)		ASTM A276 (UNS S31803)		ASTM A276 (UNS S31803)		ASTM B574 (UNS N10276)	
16. Stem Seal Material	According manufacturer standard, fitted to service conditions		According manufacturer standard, fitted to service conditions		According manufacturer standard, fitted to service conditions		PTFE	
17. Operator Type	2" - 8"	Lever	2" - 8"	Lever	2" - 8"	Lever	6"	Lever
	10" - 24"	Gearbox	10" - 24"	Gearbox	10" - 36"	Gearbox	8" - 28"	Gearbox
18. Additional Requirement	N/A		N/A		N/A		N/A	
19. Product testing	FAT according A.9.3		FAT according A.9.3		FAT according A.9.3		FAT according A.9.3	
20. Disc Coating	Polyamide Disc Coating		Polyamide Disc Coating		Polyamide Disc Coating		N/A	
21. Notes	Through holes drilled and tapped acc. to ASME B1.1		Wafer valves shall not to be used with flammable or combustible services		N/A		Through holes drilled and tapped acc. to ASME B1.1	

Valve Code	VBO-300-1-U312		VBO-300-1-U313		VBO-300-2-C112		VBO-300-2-C113	
Specs	C23		C23		C4		C10	
1. Valve Type	Butterfly, Wafer type		Butterfly, Double Flanged (short pattern)		Butterfly, Wafer type		Butterfly, Double Flanged (short pattern)	
2. Sealing Type	Soft		Soft		Soft		Soft	
3. Valve Specification Level (VSL)	VSL-1		VSL-1		VSL-2		VSL-2	
4. Disc & Seat Configuration	Double Offset		Double Offset		Double Offset		Double Offset	
5. Standard	API 609 Category B		API 609 Category B		API 609 Category B		API 609 Category B	
6. Size Range (NPS)	6" - 28"		6" - 32"		6" - 24"		3" - 32"	
7. End Connection	6" - 24"	ASME B16.5, RF	6" - 24"	ASME B16.5, RF	ASME B16.5, RF		3" - 24"	ASME B16.5, RF
	26" - 28"	ASME B16.47 Series A, RF	26" - 32"	ASME B16.47 Series A, RF	N/A		26" - 32"	ASME B16.47 Series A, RF
8. Pressure Class	300		300		300		300	
9. Temperature	0°C to 75°C		0°C to 75°C		0°C to 240°C		0°C to 240°C	
10. Material Class	Uncommon Materials		Uncommon Materials		Carbon Steel		Carbon Steel	
11. Body Material	ASTM B148 (UNS C95800)		ASTM B148 (UNS C95800)		ASTM A105 or ASTM A216 Gr WCB		ASTM A105 or ASTM A216 Gr WCB	
12. Disc Material	ASTM B148 (UNS C95800)		ASTM B148 (UNS C95800)		AISI 316		AISI 316	
13. Seat Material	RPTFE		RPTFE		RPTFE		RPTFE	
14. Seal Ring	N/A		N/A		N/A		N/A	
15. Stem Material	ASTM B574 (UNS N10276)		ASTM B574 (UNS N10276)		ASTM A564 Type 630 H1150 (UNS S17400)		ASTM A564 Type 630 H1150 (UNS S17400)	
16. Stem Seal Material	PTFE		PTFE		According manufacturer standard, fitted to service conditions		According manufacturer standard, fitted to service conditions	
17. Operator Type	6"	Lever	6"	Lever	6"	Lever	3" - 6"	Lever
	8" - 28"	Gearbox	8" - 32"	Gearbox	8" - 24"	Gearbox	8" - 32"	Gearbox
18. Additional Requirement	N/A		N/A		N/A		N/A	
19. Product testing	FAT according A.9.3		FAT according A.9.3		FAT according A.9.3		FAT according A.9.3	
20. Disc Coating	N/A		N/A		N/A		N/A	
21. Notes	Wafer valves shall not to be used with flammable or combustible services		N/A		N/A		N/A	

Valve Code	VBO-300-2-D211		VBO-300-2-D212		VBO-300-2-D213		VBO-300-2-D312	
Specs	C11 C16		C11 C16		C11 C16		C12	
1. Valve Type	Butterfly, Lug type		Butterfly, Wafer type		Butterfly, Double Flanged (short pattern)		Butterfly, Wafer type	
2. Sealing Type	Soft		Soft		Soft		Soft	
3. Valve Specification Level (VSL)	VSL-2		VSL-2		VSL-2		VSL-2	
4. Disc & Seat Configuration	Double Offset		Double Offset		Double Offset		Double Offset	
5. Standard	API 609 Category B		API 609 Category B		API 609 Category B		API 609 Category B	
6. Size Range (NPS)	6" - 24"		6" - 24"		6" - 24"		6" - 30"	
7. End Connection	ASME B16.5, RF		ASME B16.5, RF		ASME B16.5, RF		6" - 24" ASME B16.5, RF	
	N/A		N/A		N/A		26" - 30" ASME B16.47 Series A, RF	
8. Pressure Class	300		300		300		300	
9. Temperature	-46°C to 150°C		-46°C to 150°C		-46°C to 150°C		0°C to 150°C	
10. Material Class	Duplex Steel		Duplex Steel		Duplex Steel		Duplex Steel	
11. Body Material	ASTM A182 Gr F51 or ASTM A995 Gr 4a		ASTM A182 Gr F51 or ASTM A995 Gr 4a		ASTM A182 Gr F51 or ASTM A995 Gr 4a		ASTM A182 Gr F55 or ASTM A995 Gr 6a	
12. Disc Material	Duplex (UNS S31803)		Duplex (UNS S31803)		Duplex (UNS S31803)		Super Duplex (UNS S32760)	
13. Seat Material	RPTFE		RPTFE		RPTFE		RPTFE	
14. Seal Ring	N/A		N/A		N/A		N/A	
15. Stem Material	ASTM A276 (UNS S31803)		ASTM A276 (UNS S31803)		ASTM A276 (UNS S31803)		ASTM A276 (UNS S32760)	
16. Stem Seal Material	According manufacturer standard, fitted to service conditions		According manufacturer standard, fitted to service conditions		According manufacturer standard, fitted to service conditions		According manufacturer standard, fitted to service conditions	
17. Operator Type	6"	Lever	6"	Lever	6"	Lever	6"	Lever
	8" - 24"	Gearbox	8" - 24"	Gearbox	8" - 24"	Gearbox	8" - 30"	Gearbox
18. Additional Requirement	N/A		N/A		N/A		N/A	
19. Product testing	FAT according A.9.3		FAT according A.9.3		FAT according A.9.3		FAT according A.9.3	
20. Disc Coating	N/A		N/A		N/A		N/A	
21. Notes	Through holes drilled and tapped acc. to ASME B1.1		Wafer valves shall not to be used with flammable or combustible services		N/A		Wafer valves shall not to be used with flammable or combustible services	

Valve Code	VBO-300-2-D313		VBO-300-2-S213		VBO-300-2-S216		VBO-300-3-C123	
Specs	C12		C3		C3		C4 C10	
1. Valve Type	Butterfly, Double Flanged (short pattern)		Butterfly, Double Flanged (short pattern)		Butterfly, Double Flanged (short pattern)		Butterfly, Double Flanged (short pattern)	
2. Sealing Type	Soft		Soft		Soft		Metal to Metal	
3. Valve Specification Level (VSL)	VSL-2		VSL-2		VSL-2		VSL-3	
4. Disc & Seat Configuration	Double Offset		Double Offset		Double Offset		Triple Offset	
5. Standard	API 609 Category B		API 609 Category B		API 609 Category B		API 609 Category B	
6. Size Range (NPS)	6" - 30"		6" - 30"		6" - 30"		3" - 26"	
7. End Connection	6" - 24"	ASME B16.5, RF	6" - 24"	ASME B16.5, RF	6" - 24"	ASME B16.5, RF	3" - 24"	ASME B16.5, RF
	26" - 30"	ASME B16.47 Series A, RF	26" - 30"	ASME B16.47 Series A, RF	26" - 30"	ASME B16.47 Series A, RF	26"	ASME B16.47 Series A, RF
8. Pressure Class	300		300		300		300	
9. Temperature	0°C to 150°C		-46°C to 150°C		-100°C to 150°C		-29°C to 240°C	
10. Material Class	Duplex Steel		Stainless Steel		Stainless Steel		Carbon Steel	
11. Body Material	ASTM A182 Gr F55 or ASTM A995 Gr 6a		ASTM A182 Gr F316 or ASTM A351 Gr CF8M		ASTM A182 Gr F316 or ASTM A351 Gr CF8M		ASTM A105	
12. Disc Material	Super Duplex (UNS S32760)		AISI 316		AISI 316		AISI 316	
13. Seat Material	RPTFE		RPTFE		According to manufacturer		AISI 316 + Metallic Coating (acc. Item A.7.5.4.3.2)	
14. Seal Ring	N/A		N/A		N/A		Graphite Laminated with AISI 316	
15. Stem Material	ASTM A276 (UNS S32760)		ASTM A564 Type 630 H1150 (UNS S17400)		ASTM A276 (UNS S31600)		ASTM A564 Type 630 H1150 (UNS S17400)	
16. Stem Seal Material	According manufacturer standard, fitted to service conditions		According manufacturer standard, fitted to service conditions		According manufacturer standard, fitted to service conditions		Graphite Based Seal	
17. Operator Type	6"	Lever	6"	Lever	6"	Lever	N/A	
	8" - 30"	Gearbox	8" - 30"	Gearbox	8" - 30"	Gearbox	N/A	
18. Additional Requirement	N/A		N/A		N/A		Fire Tested (acc. item A.6.1.4)	
19. Product testing	FAT according A.9.3		FAT according A.9.3		FAT according A.9.3		FAT according A.9.3	
20. Disc Coating	N/A		N/A		N/A		N/A	
21. Notes	N/A		N/A		N/A		Acceptance criteria for all HP/LP seat tests (Normative/Supplementary): ISO 5208 Rate A	

Valve Code	VBO-300-3-C223		VBO-300-3-D223		VBO-300-3-D323		VBO-600-3-A523	
Specs	C6 C19		C11		C12		E32	
1. Valve Type	Butterfly, Double Flanged (short pattern)		Butterfly, Double Flanged (short pattern)		Butterfly, Double Flanged (short pattern)		Butterfly, Double Flanged (short pattern)	
2. Sealing Type	Metal to Metal		Metal to Metal		Metal to Metal		Metal to Metal	
3. Valve Specification Level (VSL)	VSL-3		VSL-3		VSL-3		VSL-3	
4. Disc & Seat Configuration	Triple Offset		Triple Offset		Triple Offset		Triple Offset	
5. Standard	API 609 Category B		API 609 Category B		API 609 Category B		API 609 Category B	
6. Size Range (NPS)	10" - 30"		6" - 16"		6" - 30"		6" - 16"	
7. End Connection	10" - 24"	ASME B16.5, RF	ASME B16.5, RF		6" - 24"	ASME B16.5, RF	ASME B16.5, RF	
	26" - 30"	ASME B16.47 Series A, RF	N/A		26" - 30"	ASME B16.47 Series A, RF	N/A	
8. Pressure Class	300		300		300		600	
9. Temperature	-46°C to 240°C		-46°C to 150°C		-46°C to 150°C		-100°C to 345°C	
10. Material Class	Carbon Steel		Duplex Steel		Duplex Steel		Alloy Steel	
11. Body Material	ASTM A350 Gr LF2 CL1		ASTM A182 Gr F51		ASTM A182 Gr F55		ASTM A350 Gr LF3 + Inconel 625 weld overlay (acc. item A.7.1.7.3)	
12. Disc Material	AISI 316		Duplex (UNS S31803)		Super Duplex (UNS S32760)		ASTM A350 Gr LF3 + Inconel 625 weld overlay (acc. item A.7.1.7.3)	
13. Seat Material	AISI 316 + Metallic Coating (acc. Item A.7.5.4.3.2)		Duplex (UNS S31803) + Metallic Coating (acc. Item A.7.5.4.3.2)		Super Duplex (UNS S32760) + Metallic Coating (acc. Item A.7.5.4.3.2)		ASTM B564 (UNS N06625) + Metallic Coating (acc. Item A.7.5.4.3.2)	
14. Seal Ring	Graphite Laminated with AISI 316		Graphite Laminated with Duplex (UNS S31803)		Graphite Laminated with Super Duplex (UNS S32760)		Graphite Laminated with ASTM B564 (UNS N06625)	
15. Stem Material	ASTM A564 Type 630 H1150 (UNS S17400)		ASTM A276 (UNS S31803)		ASTM A276 (UNS S32760)		ASTM B637 (UNS N07718)	
16. Stem Seal Material	Graphite Based Seal		Graphite Based Seal		Graphite Based Seal		Graphite Based Seal	
17. Operator Type	Gearbox		Gearbox		Gearbox		Gearbox	
18. Additional Requirement	Fire Tested (acc. item A.6.1.4)		Fire Tested (acc. item A.6.1.4)		Fire Tested (acc. item A.6.1.4)		Fire Tested (acc. item A.6.1.4)	
19. Product testing	FAT according A.9.3		FAT according A.9.3		FAT according A.9.3		FAT according A.9.3	
20. Disc Coating	N/A		N/A		N/A		Full clad - Inconel 625 weld overlay on all wetted parts	
21. Notes	Acceptance criteria for all HP/LP seat tests (Normative/Supplementary): ISO 5208 Rate A		Acceptance criteria for all HP/LP seat tests (Normative/Supplementary): ISO 5208 Rate A		Acceptance criteria for all HP/LP seat tests (Normative/Supplementary): ISO 5208 Rate A		Acceptance criteria for all HP/LP seat tests (Normative/Supplementary): ISO 5208 Rate A	

Valve Code	VBO-600-3-D223	VBO-600-3-S223	VBO-900-3-C223	VBO-900-3-S223
Specs	E16	E3	F6	F3
1. Valve Type	Butterfly, Double Flanged (short pattern)	Butterfly, Double Flanged (short pattern)	Butterfly, Double Flanged (short pattern)	Butterfly, Double Flanged (short pattern)
2. Sealing Type	Metal to Metal	Metal to Metal	Metal to Metal	Metal to Metal
3. Valve Specification Level (VSL)	VSL-3	VSL-3	VSL-3	VSL-3
4. Disc & Seat Configuration	Triple Offset	Triple Offset	Triple Offset	Triple Offset
5. Standard	API 609 Category B	API 609 Category B	API 609 Category B	API 609 Category B
6. Size Range (NPS)	6" - 16"	6" - 24"	6" - 20"	6" - 18"
7. End Connection	ASME B16.5, RF	ASME B16.5, RF	ASME B16.5, RTJ	ASME B16.5, RTJ
8. Pressure Class	600	600	900	900
9. Temperature	-46°C to 150°C	-100°C to 345°C	-46°C to 340°C	-100°C to 345°C
10. Material Class	Duplex Steel	Stainless Steel	Carbon Steel	Stainless Steel
11. Body Material	ASTM A182 Gr F51	ASTM A182 Gr F316	ASTM A350 Gr LF2 CL1	ASTM A182 Gr F316
12. Disc Material	Duplex (UNS S31803)	AISI 316	AISI 316	AISI 316
13. Seat Material	Duplex (UNS S31803) + Metallic Coating (acc. Item A.7.5.4.3.2)	AISI 316 + Metallic Coating (acc. Item A.7.5.4.3.2)	AISI 316 + Metallic Coating (acc. Item A.7.5.4.3.2)	AISI 316 + Metallic Coating (acc. Item A.7.5.4.3.2)
14. Seal Ring	Graphite Laminated with Duplex (UNS S31803)	Graphite Laminated with AISI 316	Graphite Laminated with AISI 316	Graphite Laminated with AISI 316
15. Stem Material	ASTM A276 (UNS S31803)	ASTM A276 (UNS S31600)	ASTM A564 Type 630 H1150 (UNS S17400)	ASTM A276 (UNS S31600)
16. Stem Seal Material	Graphite Based Seal	Graphite Based Seal	Graphite Based Seal	Graphite Based Seal
17. Operator Type	Gearbox	Gearbox	Gearbox	Gearbox
18. Additional Requirement	Fire Tested (acc. item A.6.1.4)	Fire Tested (acc. item A.6.1.4)	Fire Tested (acc. item A.6.1.4)	Fire Tested (acc. item A.6.1.4)
19. Product testing	FAT according A.9.3	FAT according A.9.3	FAT according A.9.3	FAT according A.9.3
20. Disc Coating	N/A	N/A	N/A	N/A
21. Notes	Acceptance criteria for all HP/LP seat tests (Normative/Supplementary): ISO 5208 Rate A	Acceptance criteria for all HP/LP seat tests (Normative/Supplementary): ISO 5208 Rate A	Acceptance criteria for all HP/LP seat tests (Normative/Supplementary): ISO 5208 Rate A	Acceptance criteria for all HP/LP seat tests (Normative/Supplementary): ISO 5208 Rate A

A.12.9 PLUG VALVES

Valve Code	VMA-150-2-C101		VMA-150-2-C201		VMA-150-2-D301		VMA-150-2-S201	
Specs	B10		B6 B9		B12		B3	
1. Valve Type	Plug		Plug		Plug		Plug	
2. Sealing Type	Metal to Metal		Metal to Metal		Metal to Metal		Metal to Metal	
3. Valve Specification Level (VSL)	VSL-2		VSL-2		VSL-2		VSL-2	
4. Obturator Type	Expanding slips		Expanding slips		Expanding slips		Expanding slips	
5. Standard	API 6D		API 6D		API 6D		API 6D	
6. Size Range (NPS)	2" - 24"		2" - 24"		2" - 24"		2" - 24"	
7. End Connection	ASME B16.5, RF		ASME B16.5, RF		ASME B16.5, RF		ASME B16.5, RF	
8. Pressure Class	150		150		150		150	
9. Temperature	0°C to 93°C		-30°C to 93°C		0°C to 93°C		-30°C to 93°C	
10. Material Class	Carbon Steel		Carbon Steel		Duplex Steel		Stainless Steel	
11. Body Material	ASTM A216 Gr WCB		ASTM A352 Gr LCB		ASTM A995 Gr 6a		ASTM A182 Gr CF8M	
12. Plug Material	A216 WCB + ENP (acc. Item A.8.2.1.1)		A352 LCB + ENP (acc. Item A.8.2.1.1)		A995 6a + ENP (acc. Item A.8.2.1.1)		A351 CF8M + ENP (acc. Item A.8.2.1.1)	
13. Slips Material	ASTM A395 Gr 60-40-18		ASTM A352 Gr LCB		ASTM A995 Gr 6a		ASTM A351 Gr CF8M	
14. Seat Insert Material	FKM Type 2		FKM Type 3		FKM Type 3		FKM Type 3	
15. Spring (Seat) Material	ASTM A216 Gr WCB + ENP (acc. Item A.8.2.1.1)		ASTM A352 Gr LCB + ENP (acc. Item A.8.2.1.1)		ASTM A995 Gr 6a		ASTM A995 Gr 4a	
16. Stem Seal Material	FKM Type 2		FKM Type 3		FKM Type 2		FKM Type 3	
17. Operator Type	2" - 4"	non rising handwheel	2" - 4"	non rising handwheel	2" - 4"	non rising handwheel	2" - 4"	non rising handwheel
	6" - 24"	Gearbox	6" - 24"	Gearbox	6" - 24"	Gearbox	6" - 24"	Gearbox
18. Additional Requirement	Fire Tested (acc. item A.6.1.4)		Fire Tested (acc. item A.6.1.4)		Fire Tested (acc. item A.6.1.4)		Fire Tested (acc. item A.6.1.4)	
19. Body Construction	top entry, bottom entry		top entry, bottom entry		top entry, bottom entry		top entry, bottom entry	
20. Product Testing	FAT according A.9.3		FAT according A.9.3		FAT according A.9.3		FAT according A.9.3	
21. Cladding or Coating	N/A		N/A		N/A		N/A	
22. Notes	N/A		N/A		N/A		N/A	

Valve Code	VMA-300-2-C101		VMA-300-2-C201		VMA-300-2-S201		VMA-600-2-C101	
Specs	C9 C10		C6 C19		C3		E9 E10	
1. Valve Type	Plug		Plug		Plug		Plug	
2. Sealing Type	Metal to Metal		Metal to Metal		Metal to Metal		Metal to Metal	
3. Valve Specification Level (VSL)	VSL-2		VSL-2		VSL-2		VSL-2	
4. Obturator Type	Expanding slips		Expanding slips		Expanding slips		Expanding slips	
5. Standard	API 6D		API 6D		API 6D		API 6D	
6. Size Range (NPS)	2" - 24"		2" - 24"		2" - 24"		2" - 24"	
7. End Connection	ASME B16.5, RF		ASME B16.5, RF		ASME B16.5, RF		ASME B16.5, RF	
8. Pressure Class	300		300		300		600	
9. Temperature	0°C to 93°C		-30°C to 93°C		-30°C to 93°C		0°C to 93°C	
10. Material Class	Carbon Steel		Carbon Steel		Stainless Steel		Carbon Steel	
11. Body Material	ASTM A216 Gr WCB		ASTM A352 Gr LCB		ASTM A182 Gr CF8M		ASTM A216 Gr WCB	
12. Plug Material	A216 WCB + ENP (acc. Item A.8.2.1.1)		A352 LCB + ENP (acc. Item A.8.2.1.1)		A351 CF8M + ENP (acc. Item A.8.2.1.1)		A216 WCB + ENP (acc. Item A.8.2.1.1)	
13. Slips Material	ASTM A395 Gr 60-40-18		ASTM A352 Gr LCB		ASTM A351 Gr CF8M		ASTM A395 Gr 60-40-18	
14. Seat Insert Material	FKM Type 2		FKM Type 3		FKM Type 3		FKM Type 2	
15. Spring (Seat) Material	ASTM A216 Gr WCB + ENP (acc. Item A.8.2.1.1)		ASTM A352 Gr LCB + ENP (acc. Item A.8.2.1.1)		ASTM A995 Gr 4a		ASTM A216 Gr WCB + ENP (acc. Item A.8.2.1.1)	
16. Stem Seal Material	FKM Type 2		FKM Type 3		FKM Type 3		FKM Type 2	
17. Operator Type	2" - 3"	non rising handwheel	2" - 3"	non rising handwheel	2" - 3"	non rising handwheel	2" - 3"	non rising handwheel
	4" - 24"	Gearbox	4" - 24"	Gearbox	4" - 24"	Gearbox	4" - 24"	Gearbox
18. Additional Requirement	Fire Tested (acc. item A.6.1.4)		Fire Tested (acc. item A.6.1.4)		Fire Tested (acc. item A.6.1.4)		Fire Tested (acc. item A.6.1.4)	
19. Body Construction	top entry, bottom entry		top entry, bottom entry		top entry, bottom entry		top entry, bottom entry	
20. Product Testing	FAT according A.9.3		FAT according A.9.3		FAT according A.9.3		FAT according A.9.3	
21. Cladding or Coating	N/A		N/A		N/A		N/A	
22. Notes	N/A		N/A		N/A		N/A	

Valve Code	VMA-600-2-C201		VMA-600-2-S201		VMA-900-2-C101	VMA-900-2-C201
Specs	E6 E19		E3		F10	F6
1. Valve Type	Plug		Plug		Plug	Plug
2. Sealing Type	Metal to Metal		Metal to Metal		Metal to Metal	Metal to Metal
3. Valve Specification Level (VSL)	VSL-2		VSL-2		VSL-2	VSL-2
4. Obturator Type	Expanding slips		Expanding slips		Expanding slips	Expanding slips
5. Standard	API 6D		API 6D		API 6D	API 6D
6. Size Range (NPS)	2" - 24"		2" - 16"		2" - 10"	2" - 10"
7. End Connection	ASME B16.5, RF		ASME B16.5, RF		ASME B16.5, RTJ	ASME B16.5, RTJ
8. Pressure Class	600		600		900	900
9. Temperature	-30°C to 93°C		-30°C to 93°C		0°C to 93°C	-30°C to 93°C
10. Material Class	Carbon Steel		Stainless Steel		Carbon Steel	Carbon Steel
11. Body Material	ASTM A352 Gr LCB		ASTM A182 Gr CF8M		ASTM A216 Gr WCB	ASTM A352 Gr LCB
12. Plug Material	A352 LCB + ENP (acc. Item A.8.2.1.1)		A351 CF8M + ENP (acc. Item A.8.2.1.1)		A216 WCB + ENP (acc. Item A.8.2.1.1)	A352 LCB + ENP (acc. Item A.8.2.1.1)
13. Slips Material	ASTM A352 Gr LCB		ASTM A351 Gr CF8M		ASTM A395 Gr 60-40-18	ASTM A352 Gr LCB
14. Seat Insert Material	FKM Type 3		FKM Type 3		FKM Type 2	FKM Type 3
15. Spring (Seat) Material	ASTM A352 Gr LCB + ENP (acc. Item A.8.2.1.1)		ASTM A995 Gr 4a		ASTM A216 Gr WCB + ENP (acc. Item A.8.2.1.1)	ASTM A352 Gr LCB + ENP (acc. Item A.8.2.1.1)
16. Stem Seal Material	FKM Type 3		FKM Type 3		FKM Type 2	FKM Type 3
17. Operator Type	2" - 3"	non rising handwheel	2" - 3"	non rising handwheel	Gearbox	Gearbox
	4" - 24"	Gearbox	4" - 16"	Gearbox		
18. Additional Requirement	Fire Tested (acc. item A.6.1.4)		Fire Tested (acc. item A.6.1.4)		Fire Tested (acc. item A.6.1.4)	Fire Tested (acc. item A.6.1.4)
19. Body Construction	top entry, bottom entry		top entry, bottom entry		top entry, bottom entry	top entry, bottom entry
20. Product Testing	FAT according A.9.3		FAT according A.9.3		FAT according A.9.3	FAT according A.9.3
21. Cladding or Coating	N/A		N/A		N/A	N/A
22. Notes	N/A		N/A		N/A	N/A

Valve Code	VMA-900-2-S201
Specs	F3
1. Valve Type	Plug
2. Sealing Type	Metal to Metal
3. Valve Specification Level (VSL)	VSL-2
4. Obturator Type	Expanding slips
5. Standard	API 6D
6. Size Range (NPS)	2" - 10"
7. End Connection	ASME B16.5, RTJ
8. Pressure Class	900
9. Temperature	-30°C to 93°C
10. Material Class	Stainless Steel
11. Body Material	ASTM A182 Gr CF8M
12. Plug Material	A351 CF8M + ENP (acc. Item A.8.2.1.1)
13. Slips Material	ASTM A351 Gr CF8M
14. Seat Insert Material	FKM Type 3
15. Spring (Seat) Material	ASTM A995 Gr 4a
16. Stem Seal Material	FKM Type 3
17. Operator Type	Gearbox
18. Additional Requirement	Fire Tested (acc. item A.6.1.4)
19. Body Construction	top entry, bottom entry
20. Product Testing	FAT according A.9.3
21. Cladding or Coating	N/A
22. Notes	N/A

A.12.10 NEEDLE VALVES

Valve Code	VAG-150-1-D201	VAG-150-1-D301	VAG-3000-1-D202	VAG-3000-1-D302
Specs	B11	B27	B16 C16 E16	B12 C12
1. Valve Type	Needle	Needle	Needle	Needle
2. Sealing Type	Metal to Metal	Metal to Metal	Metal to Metal	Metal to Metal
3. Valve Specification Level (VSL)	VSL-1	VSL-1	VSL-1	VSL-1
4. Obturator Type	Rising Plug	Rising Plug	Rising Plug	Rising Plug
5. Standard	ASME 16.34 LTD	ASME 16.34 LTD	ASME 16.34 LTD	ASME 16.34 LTD
6. Size Range (NPS)	1" - 1 ½"	1" - 1 ½"	½" - 1 ½"	½" - 1 ½"
7. End Connection	Flange ASME B16.5 (CL150), RF	Flange ASME B16.5 (CL150), RF	socket weld ends ASME B16.11	socket weld ends ASME B16.11
8. Pressure Class	150	150	max. pressure 3000 psi	max. pressure 3000 psi
9. Temperature	-50°C to 150°C	-50°C to 150°C	-46°C to 150°C	-46°C to 150°C
10. Material Class	Duplex Steel	Duplex Steel	Duplex Steel	Duplex Steel
11. Body Material	ASTM A182 Gr F51	ASTM A182 Gr F55	ASTM A182 Gr F51	ASTM A182 Gr F55
12. Obturator Material	ASTM A182 Gr F51	ASTM A182 Gr F55	ASTM A182 Gr F51	ASTM A182 Gr F55
13. Seat Material	ASTM A182 Gr F51	ASTM A182 Gr F55	ASTM A182 Gr F51	ASTM A182 Gr F55
14. Stem Seal Material	N/A	N/A	N/A	N/A
15. Body Construction	PTFE	PTFE	Graphoil	Graphoil
16. Additional Requirement	N/A	N/A	N/A	N/A
17. Operator Type	Rising Handwheel	Rising Handwheel	Rising Handwheel	Rising Handwheel
18. Stem Design	rising stem, inside screw stem; Stem swivel	rising stem, inside screw stem; Stem swivel	rising stem, inside screw stem; Stem swivel	rising stem, inside screw stem; Stem swivel
19. Product testing	FAT according A.9.3	FAT according A.9.3	FAT according A.9.3	FAT according A.9.3
20. Coating or Cladding	N/A	N/A	N/A	N/A
21. Notes	N/A	N/A	N/A	N/A

Valve Code	VAG-3000-1-N102	VAG-3000-1-S201	VAG-3000-1-S202	VAG-5000-1-S201
Specs	B30 C30 E30 E32	B3 B4 B6 B9 B10 B19 C3 C4 C6 C9 C10 C19 E3 E6 E9 E10 E19 F3 F6 F10 R3B R3C R9B R9C S3B S3C S9B S9C	B3 B4 B6 B9 B10 B19 C3 C4 C6 C9 C10 C19 E3 E6 E9 E10 E19 F3 F6 F10	G3 G10P
1. Valve Type	Needle	Needle	Needle	Needle
2. Sealing Type	Metal to Metal	Metal to Metal	Metal to Metal	Metal to Metal
3. Valve Specification Level (VSL)	VSL-1	VSL-1	VSL-1	VSL-1
4. Obturator Type	Rising Plug	Rising Plug	Rising Plug	Rising Plug
5. Standard	ASME 16.34 LTD	ASME 16.34 LTD	ASME 16.34 LTD	ASME 16.34 LTD
6. Size Range (NPS)	½" - 1 ½"	½" - 1 ½"	½" - 1 ½"	½" - 1 ½"
7. End Connection	socket weld ends ASME B16.11	socket weld ends ASME B16.11	socket weld ends ASME B16.11	socket weld ends ASME B16.11
8. Pressure Class	max. pressure 3000 psi	max. pressure 3000 psi	max. pressure 3000 psi	max. pressure 5000 psi
9. Temperature	-100°C to 400°C	-100°C to 200°C	-100°C to 400°C	-100°C to 200°C
10. Material Class	Nickel Alloys	Stainless Steel	Stainless Steel	Stainless Steel
11. Body Material	ASTM B564 (UNS N06625)	ASTM A182 Gr F316/316L	ASTM A182 Gr F316/316L	ASTM A182 Gr F316/316L
12. Obturator Material	ASTM B564 (UNS N06625)	Stainless Steel with hardness superior to seat	Stainless Steel with hardness superior to seat	Stainless Steel with hardness superior to seat
13. Seat Material	ASTM B564 (UNS N06625)	ASTM A 182 Gr F316L	ASTM A 182 Gr F316L	ASTM A 182 Gr F316L
14. Stem Seal Material	N/A	N/A	N/A	N/A
15. Body Construction	Graphoil	PTFE	Graphoil	PTFE
16. Additional Requirement	N/A	N/A	N/A	N/A
17. Operator Type	Rising Handwheel	Rising Handwheel	Rising Handwheel	Rising Handwheel
18. Stem Design	rising stem, inside screw stem; Stem swivel	rising stem, inside screw stem; Stem swivel	rising stem, inside screw stem; Stem swivel	rising stem, inside screw stem; Stem swivel
19. Product testing	FAT according A.9.3	FAT according A.9.3	FAT according A.9.3	FAT according A.9.3
20. Coating or Cladding	N/A	N/A	N/A	N/A
21. Notes	N/A	N/A	N/A	N/A

Valve Code	VAG-5000-1-S202	VAG-6000-1-D302	VAG-6000-1-N102	VAG-6000-1-S201
Specs	G3 G10P	H12	H30P H30	H3 H6 H10
1. Valve Type	Needle	Needle	Needle	Needle
2. Sealing Type	Metal to Metal	Metal to Metal	Metal to Metal	Metal to Metal
3. Valve Specification Level (VSL)	VSL-1	VSL-1	VSL-1	VSL-1
4. Obturator Type	Rising Plug	Rising Plug	Rising Plug	Rising Plug
5. Standard	ASME 16.34 LTD	ASME 16.34 LTD	ASME 16.34 LTD	ASME 16.34 LTD
6. Size Range (NPS)	½" - 1 ½"	1" - 1 ½"	1" - 1 ½"	1" - 1 ½"
7. End Connection	socket weld ends ASME B16.11	butt weld ASME B16.25	butt weld ASME B16.25	butt weld ASME B16.25
8. Pressure Class	max. pressure 5000 psi	max. pressure 6000 psi	max. pressure 6000 psi	max. pressure 6000 psi
9. Temperature	-100°C to 400°C	-50°C to 150°C	-100°C to 400°C	-100°C to 200°C
10. Material Class	Stainless Steel	Duplex Steel	Nickel Alloys	Stainless Steel
11. Body Material	ASTM A182 Gr F316/316L	ASTM A182 Gr F55	ASTM B564 (UNS N06625)	ASTM A182 Gr F316/316L
12. Obturator Material	Stainless Steel with hardness superior to seat	ASTM A182 Gr F55	ASTM B564 (UNS N06625)	Stainless Steel with hardness superior to seat
13. Seat Material	ASTM A 182 Gr F316L	ASTM A182 Gr F55	ASTM B564 (UNS N06625)	ASTM A 182 Gr F316L
14. Stem Seal Material	N/A	N/A	N/A	N/A
15. Body Construction	Graphoil	Graphoil	Graphoil	PTFE
16. Additional Requirement	N/A	N/A	N/A	N/A
17. Operator Type	Rising Handwheel	Rising Handwheel	Rising Handwheel	Rising Handwheel
18. Stem Design	rising stem, inside screw stem; Stem swivel	rising stem, inside screw stem; Stem swivel	rising stem, inside screw stem; Stem swivel	rising stem, inside screw stem; Stem swivel
19. Product testing	FAT according A.9.3	FAT according A.9.3	FAT according A.9.3	FAT according A.9.3
20. Coating or Cladding	N/A	N/A	N/A	N/A
21. Notes	N/A	N/A	N/A	N/A

Valve Code	VAG-6000-1-S202
Specs	H3 H6 H10
1. Valve Type	Needle
2. Sealing Type	Metal to Metal
3. Valve Specification Level (VSL)	VSL-1
4. Obturator Type	Rising Plug
5. Standard	ASME 16.34 LTD
6. Size Range (NPS)	1" - 1 ½"
7. End Connection	butt weld ASME B16.25
8. Pressure Class	max. pressure 6000 psi
9. Temperature	-100°C to 400°C
10. Material Class	Stainless Steel
11. Body Material	ASTM A182 Gr F316/316L
12. Obturator Material	Stainless Steel with hardness superior to seat
13. Seat Material	ASTM A 182 Gr F316L
14. Stem Seal Material	N/A
15. Body Construction	Graphoil
16. Additional Requirement	N/A
17. Operator Type	Rising Handwheel
18. Stem Design	rising stem, inside screw stem; Stem swivel
19. Product testing	FAT according A.9.3
20. Coating or Cladding	N/A
21. Notes	N/A

A.12.11 DIAPHRAGM VALVES

Valve Code	VDI-150-2-U301	VDI-250-2-U301	VDI-300-2-U301
Specs	B7R	B7R	B7
1. Valve Type	Diaphragm	Diaphragm	Diaphragm
2. Sealing Type	Soft	Soft	Soft
3. Valve Specification Level (VSL)	VSL-2	VSL-2	VSL-2
4. Obturator Type	Diaphragm	Diaphragm	Diaphragm
5. Standard	According Manufacturer Standard	According Manufacturer Standard	According Manufacturer Standard
6. Size Range (NPS)	2" - 12"	2" - 12"	2" - 12"
7. End Connection	Flange ASME B16.5 (CL150), RF	Flange ASME B16.5 (CL150), RF	Flange ASME B16.5 (CL150), RF
8. Pressure Class	max. press 150 psig	max. press 250 psig	max. press 300 psig
9. Temperature	0°C to 80°C	0°C to 80°C	0°C to 80°C
10. Material Class	Uncommon Materials	Uncommon Materials	Uncommon Materials
11. Body Material	ASTM B148 (UNS C95800)	ASTM B148 (UNS C95800)	ASTM B148 (UNS C95800)
12. Diaphragm Material	NBR	NBR	NBR
13. Stem Material	ASTM B150 (UNS C63200)	ASTM B150 (UNS C63200)	ASTM B150 (UNS C63200)
14. Spring Material	UNS N07750	UNS N07750	UNS N07750
15. Additional Requirement	N/A	N/A	N/A
16. Body Construction	Top entry	Top entry	Top entry
16. Stem Seal Material	N/A	N/A	N/A
17. Product Testing	FAT according A.9.3	FAT according A.9.3	FAT according A.9.3
18. Cladding or Coating	N/A	N/A	N/A
19. Notes	N/A	N/A	N/A

A.12.12 AXIAL VALVES

Valve Code	VAX-2510-3-D201	VAX-2510-3-D301		VAX-2510-4-D201	VAX-2510-4-D202
Specs	H16	H12 H30		H16	H16
1. Valve Type	Axial	Axial		Axial	Axial
2. Sealing Type	Soft	Soft		Soft	Soft
3. Valve Specification Level (VSL)	VSL-3	VSL-3		VSL-4	VSL-4
4. Obturator Type	Piston type	Piston type		Piston type	Piston type
5. Standard	ASME B16.34	ASME B16.34		ASME B16.34	ASME B16.34
6. Size Range (NPS)	6" - 12"	6" - 24"		6" - 12"	6" - 12"
7. End Connection	ASME B16.5, Ring Type Joint	6" - 12"	ASME B16.5, Ring Type Joint	ASME B16.5, Ring Type Joint	ASME B16.5, Ring Type Joint
	N/A	14" - 24"	ISO 27509, IX seal ring		
8. Pressure Class	2500	2500		2500	2500
9. Temperature	-50°C to 120°C	-50°C to 120°C		-50°C to 120°C	-50°C to 120°C
10. Material Class	Duplex Steel	Duplex Steel		Duplex Steel	Duplex Steel
11. Body Material	ASTM A995 Gr 4a	ASTM A995 Gr 6a		ASTM A995 Gr 4a	ASTM A995 Gr 4a
12. Obturator Material	ASTM A995 Gr 4a	ASTM A995 Gr 6a		ASTM A995 Gr 4a	ASTM A995 Gr 4a
13. Seat Material	ASTM A995 Gr 4a	ASTM A995 Gr 6a		ASTM A995 Gr 4a	ASTM A995 Gr 4a
14. Seat Insert	According to manufacturer standard, fitted to service conditions	According to manufacturer standard, fitted to service conditions		According to manufacturer standard, fitted to service conditions	According to manufacturer standard, fitted to service conditions
15. Stem Material	ASTM A322 (UNS G41300)	ASTM A322 (UNS G41300)		ASTM A322 (UNS G41300)	ASTM A322 (UNS G41300)
16. Stem Seal	PEEK spring energized	PEEK spring energized		PEEK spring energized	PEEK spring energized
17. Operator Type	Gearbox	Gearbox		Gearbox	Gearbox
18. Additional Requirement	Fire Tested (acc. item A.6.1.4)	Fire Tested (acc. item A.6.1.4)		Fire Tested (acc. item A.6.1.4)	Fire Tested (acc. item A.6.1.4); SIL-3 (see notes)
19. Cladding or Coating	N/A	N/A		N/A	N/A
20. Valve Testing	FAT according A.9.3	FAT according A.9.3		FAT according A.9.3	FAT according A.9.3 and HIPPS in place test according A.9.3.7
21. Notes	N/A	N/A		N/A	SIL-3 requirements according A.6.1.6 (for HIPPS valves)

OFFSHORE PRODUCTION FACILITIES
PIPING SPECIFICATION FOR TOPSIDE

Valve Code	VAX-2510-4-D301		VAX-2510-4-D302	
Specs	H12 H30		H12 H30	
1. Valve Type	Axial		Axial	
2. Sealing Type	Soft		Soft	
3. Valve Specification Level (VSL)	VSL-4		VSL-4	
4. Obturator Type	Piston type		Piston type	
5. Standard	ASME B16.34		ASME B16.34	
6. Size Range (NPS)	6" - 24"		6" - 24"	
7. End Connection	6" - 12"	ASME B16.5, Ring Type Joint	6" - 12"	ASME B16.5, Ring Type Joint
	14" - 24"	ISO 27509, IX seal ring	14" - 24"	ISO 27509, IX seal ring
8. Pressure Class	2500		2500	
9. Temperature	-50°C to 120°C		-50°C to 120°C	
10. Material Class	Duplex Steel		Duplex Steel	
11. Body Material	ASTM A995 Gr 6a		ASTM A995 Gr 6a	
12. Obturator Material	ASTM A995 Gr 6a		ASTM A995 Gr 6a	
13. Seat Material	ASTM A995 Gr 6a		ASTM A995 Gr 6a	
14. Seat Insert	According to manufacturer standard, fitted to service conditions		According to manufacturer standard, fitted to service conditions	
15. Stem Material	ASTM A322 (UNS G41300)		ASTM A322 (UNS G41300)	
16. Stem Seal	PEEK spring energized		PEEK spring energized	
17. Operator Type	Gearbox		Gearbox	
18. Additional Requirement	Fire Tested (acc. item A.6.1.4)		Fire Tested (acc. item A.6.1.4); SIL-3 (see notes)	
19. Cladding or Coating	N/A		N/A	
20. Valve Testing	FAT according A.9.3		FAT according A.9.3 and HIPPS in place test according A.9.3.7	
21. Notes	N/A		SIL-3 requirements according A.6.1.6 (for HIPPS valves)	

A.12.13 BRONZE VALVES

Valve Code	VAN-150-1-U101	VGA-150-1-U102	VGA-200-1-U101	VGL-150-1-U101
Specs	B7R B7	B14	B7R B7 S7	B7R B7
1. Valve Type	Angular Valve	Gate Valve	Gate Valve	Globe Valve
2. Sealing Type	Metal to Metal	Metal to Metal	Metal to Metal	Metal to Metal
3. Valve Specification Level (VSL)	VSL-1	VSL-1	VSL-1	VSL-1
4. Obturator Type	Bevelled Disc	Solid Wedge	Solid Wedge	Bevelled Disc
5. Standard	MSS SP-80	MSS SP-80	MSS SP-80	MSS SP-80
6. Size Range (NPS)	2 ½"	1" - 3"	½" - 3"	½" - 1 ½"
7. End Connection	Inlet: flange acc. B16.24 - Outlet: Male-threaded acc. NFPA 1693 2,5-7,5 NH	Flat Face, ASME B16.24	Screwed ends, ASME B1.20.1	Screwed ends, ASME B1.20.1
8. Pressure Class	150	150	max. press 200 psig	150
9. Temperature	0°C to 75°C	-29°C to 75°C	-29°C to 75°C	0°C to 75°C
10. Material Class	Uncommon Materials	Uncommon Materials	Uncommon Materials	Uncommon Materials
11. Body Material	ASTM B62 (UNS C83600)	ASTM B62 (UNS C83600)	ASTM B61 (UNS C92200)	ASTM B62 (UNS C83600)
12. TRIM Material	N/A	N/A	N/A	N/A
13. Gate Material	ASTM B62 (UNS C83600)	ASTM B62 (UNS C83600)	ASTM B61 (UNS C92200)	ASTM B62 (UNS C83600)
14. Seat Material	ASTM B62 (UNS C83600)	ASTM B62 (UNS C83600)	ASTM B61 (UNS C92200)	ASTM B62 (UNS C83600)
15. Stem Material	According manufacturer standard, fitted to service conditions	ASTM B62 (UNS C83600)	ASTM B61 (UNS C92200)	ASTM B62 (UNS C83600)
16. Stem Seal Material	PTFE	According manufacturer standard, fitted to service conditions	According manufacturer standard, fitted to service conditions	According manufacturer standard, fitted to service conditions
17. Operator Type	Rising Handwheel	non rising handwheel	non rising handwheel	Rising Handwheel
18. Additional Requirement	N/A	N/A	N/A	N/A
19. Body Construction	screwed bonnet	union bonnet	union bonnet	union bonnet
20. Product Testing	FAT according A.9.3	FAT according A.9.3	FAT according A.9.3	FAT according A.9.3
21. Cladding or Coating	N/A	N/A	N/A	N/A
22. Stem Design	inside screw stem	inside screw stem	inside screw stem	inside screw stem

A.12.14 PLASTIC VALVES

Valve Code	VBO-150-1-U401	VBO-150-1-U402	VES-150-1-U401	VES-150-1-U402
Specs	B20	B21	B20	B21
1. Valve Type	Butterfly Valve	Butterfly Valve	Ball Valve	Ball Valve
2. Sealing Type	Soft	Soft	Soft	Soft
3. Valve Specification Level (VSL)	VSL-1	VSL-1	VSL-1	VSL-1
4. Standard	ASTM F1970	ASTM F1970	ASTM F1970	ASTM F1970
5. Size Range (NPS)	2 ½" - 8"	2 ½" - 8"	2 ½" - 6"	3" - 6"
6. End Connection	Flanged ends compatible with ASME B16.5	Flanged ends compatible with ASME B16.5	socket ends	socket ends
7. Pressure Class	max. press 150 psig	max. press 150 psig	max. press 150 psig	max. press 150 psig
8. Temperature	10°C to 40°C	10°C to 80°C	10°C to 40°C	10°C to 80°C
9. Material Class	Uncommon Materials	Uncommon Materials	Uncommon Materials	Uncommon Materials
10. Body Material	PVC	CPVC	PVC	CPVC
11. Obturator Material	PVC	CPVC	PVC	CPVC
12. Seat Material	EPDM	EPDM	EPDM	EPDM
13. Stem Material	According manufacturer standard, fitted to service conditions	According manufacturer standard, fitted to service conditions	According manufacturer standard, fitted to service conditions	According manufacturer standard, fitted to service conditions
14. Operator Type	Lever	Lever	Lever	Lever
15. Bore Type	N/A	N/A	Full Bore	Full Bore
16. Body Construction	N/A	N/A	N/A	N/A
17. Product Testing	FAT according ASTM F1970	FAT according ASTM F1970	FAT according ASTM F1970	FAT according ASTM F1970
18. Notes	For use with temperatures higher than ambient, see item A.7.6.2	For use with temperatures higher than ambient, see item A.7.6.2	For use with temperatures higher than ambient, see item A.7.6.2	For use with temperatures higher than ambient, see item A.7.6.2

Valve Code	VES-150-1-U403	VES-150-1-U404	VES-250-1-U401	VES-250-1-U402
Specs	B20 B21 B22 B23	B26	B20	B21
1. Valve Type	Ball Valve	Ball Valve	Ball Valve	Ball Valve
2. Sealing Type	Soft	Soft	Soft	Soft
3. Valve Specification Level (VSL)	VSL-1	VSL-1	VSL-1	VSL-1
4. Standard	Manufacturer standard	Manufacturer standard	ASTM F1970	ASTM F1970
5. Size Range (NPS)	4" - 44"	4" - 10"	½" - 2"	½" - 2"
6. End Connection	Flange ASME B16.1, FF	Flange ASME B16.1, FF	socket ends	socket ends
7. Pressure Class	max. press 150 psig	max. press 150 psig	max. press 250 psig	max. press 250 psig
8. Temperature	10°C to 70°C	10°C to 90°C	10°C to 40°C	10°C to 80°C
9. Material Class	Uncommon Materials	Uncommon Materials	Uncommon Materials	Uncommon Materials
10. Body Material	glass-fiber reinforced vinyl ester	glass-fiber reinforced vinyl ester	PVC	CPVC
11. Obturator Material	Glass fiber reinforced vinyl ester resin	Glass Fiber reinforced novolac epoxy	PVC	CPVC
12. Seat Material	Glass fiber reinforced vinyl ester	Glass fiber reinforced vinyl ester	EPDM	EPDM
13. Stem Material	According manufacturer standard, fitted to service conditions	According manufacturer standard, fitted to service conditions	According manufacturer standard, fitted to service conditions	According manufacturer standard, fitted to service conditions
14. Operator Type	Lever	Lever	Lever	Lever
15. Bore Type	Full Bore	Full Bore	Full Bore	Full Bore
16. Body Construction	N/A	N/A	N/A	N/A
17. Product Testing	FAT according manufacturer standard	FAT according manufacturer standard	FAT according ASTM F1970	FAT according ASTM F1970
18. Notes	Any metallic parts used in valve construction and in contact with process fluid shall be made of ASTM B564 (UNS N10276), For use with temperatures higher than ambient, see item A.7.6.2	Any metallic parts used in valve construction and in contact with process fluid shall be made of ASTM B564 (UNS N10276), For use with temperatures higher than ambient, see item A.7.6.2	For use with temperatures higher than ambient, see item A.7.6.2	For use with temperatures higher than ambient, see item A.7.6.2

Valve Code	VES-250-1-U403	VES-250-1-U404	VES-275-1-U403	VES-275-1-U404
Specs	B20 B21 B22 B23	B26	B20 B21 B22 B23	B26
1. Valve Type	Ball Valve	Ball Valve	Ball Valve	Ball Valve
2. Sealing Type	Soft	Soft	Soft	Soft
3. Valve Specification Level (VSL)	VSL-1	VSL-1	VSL-1	VSL-1
4. Standard	Manufacturer standard	Manufacturer standard	Manufacturer standard	Manufacturer standard
5. Size Range (NPS)	2" - 3"	2" - 3"	1" - 1 ½"	1" - 1 ½"
6. End Connection	Flange ASME B16.1, FF	Flange ASME B16.1, FF	Flange ASME B16.1, FF	Flange ASME B16.1, FF
7. Pressure Class	max. press 250 psig	max. press 250 psig	max. press 275 psig	max. press 275 psig
8. Temperature	10°C to 70°C	10°C to 90°C	10°C to 70°C	10°C to 90°C
9. Material Class	Uncommon Materials	Uncommon Materials	Uncommon Materials	Uncommon Materials
10. Body Material	glass-fiber reinforced vinyl ester	glass-fiber reinforced vinyl ester	glass-fiber reinforced vinyl ester	glass-fiber reinforced vinyl ester
11. Obturator Material	Glass fiber reinforced vinyl ester resin	Glass Fiber reinforced novolac epoxy	Glass fiber reinforced vinyl ester resin	Glass Fiber reinforced novolac epoxy
12. Seat Material	Glass fiber reinforced vinyl ester	Glass fiber reinforced vinyl ester	Glass fiber reinforced vinyl ester	Glass fiber reinforced vinyl ester
13. Stem Material	According manufacturer standard, fitted to service conditions	According manufacturer standard, fitted to service conditions	According manufacturer standard, fitted to service conditions	According manufacturer standard, fitted to service conditions
14. Operator Type	Lever	Lever	Lever	Lever
15. Bore Type	Full Bore	Full Bore	Full Bore	Full Bore
16. Body Construction	N/A	N/A	N/A	N/A
17. Product Testing	FAT according manufacturer standard	FAT according manufacturer standard	FAT according manufacturer standard	FAT according manufacturer standard
18. Notes	Any metallic parts used in valve construction and in contact with process fluid shall be made of ASTM B564 (UNS N10276), For use with temperatures higher than ambient, see item A.7.6.2	Any metallic parts used in valve construction and in contact with process fluid shall be made of ASTM B564 (UNS N10276), For use with temperatures higher than ambient, see item A.7.6.2	Any metallic parts used in valve construction and in contact with process fluid shall be made of ASTM B564 (UNS N10276), For use with temperatures higher than ambient, see item A.7.6.2	Any metallic parts used in valve construction and in contact with process fluid shall be made of ASTM B564 (UNS N10276), For use with temperatures higher than ambient, see item A.7.6.2

OFFSHORE PRODUCTION FACILITIES
PIPING SPECIFICATION FOR TOPSIDE

Valve Code	VRE-150-1-U401	VRE-150-1-U402
Specs	B20	B21
1. Valve Type	Check Valve	Check Valve
2. Sealing Type	Soft	Soft
3. Valve Specification Level (VSL)	VSL-1	VSL-1
4. Standard	ASTM F1970	ASTM F1970
5. Size Range (NPS)	½" - 6"	½" - 6"
6. End Connection	socket ends	socket ends
7. Pressure Class	max. press 150 psig	max. press 150 psig
8. Temperature	10°C to 40°C	10°C to 80°C
9. Material Class	Uncommon Materials	Uncommon Materials
10. Body Material	PVC	CPVC
11. Obturator Material	PVC	CPVC
12. Seat Material	EPDM	EPDM
13. Stem Material	N/A	N/A
14. Operator Type	Not Applicable	Not Applicable
15. Bore Type	N/A	N/A
16. Body Construction	N/A	N/A
17. Product Testing	FAT according ASTM F1970	FAT according ASTM F1970
18. Notes	For use with temperatures higher than ambient, see item A.7.6.2	For use with temperatures higher than ambient, see item A.7.6.2

A.12.15 INSTRUMENTATION VALVES

Valve Code	VAGI-10000-1-D301	VAGI-10000-1-D302	VAGI-6000-1-S201	VAGI-6000-1-S202
Specs	T12	T12	T3	T3
1. Valve Type	Needle valve for instrumentation	Needle valve for instrumentation	Needle valve for instrumentation	Needle valve for instrumentation
2. Sealing Type	Soft	Soft	Soft	Soft
3. Valve Specification Level (VSL)	VSL-1	VSL-1	VSL-1	VSL-1
4. Obturator Type	Obturator not solid with stem	Obturator not solid with stem	Obturator not solid with stem	Obturator not solid with stem
5. Valve Standard	Manufacturer Standard	Manufacturer Standard	Manufacturer Standard	Manufacturer Standard
6. Size Range (NPS)	½" - ¾"	½" - ¾"	¼" - 1 ½"	¼" - 1 ½"
7. End Connection	OD tube connection	NPT Female	OD tube connection	NPT Female
8. Pressure Class	max. press 10000 psi	max. press 10000 psi	max. pressure 6000 psi	max. pressure 6000 psi
9. Temperature	0°C to 200°C	0°C to 200°C	0°C to 200°C	0°C to 200°C
10. Material Class	Duplex Steel	Duplex Steel	Stainless Steel	Stainless Steel
11. Body Material	ASTM A182 Gr F55 or ASTM A995 Gr 6a	ASTM A182 Gr F55 or ASTM A995 Gr 6a	ASTM A182 Gr F316	ASTM A182 Gr F316
12. Obturator Material	ASTM A182 Gr F55	ASTM A182 Gr F55	Stainless Steel with hardness superior to seat	Stainless Steel with hardness superior to seat
13. Seat Material	ASTM A276 (UNS S32760)	ASTM A276 (UNS S32760)	ASTM A276 (UNS S31600)	ASTM A276 (UNS S31600)
14. Stem Seal	PTFE	PTFE	PTFE	PTFE
15. Operator Type	Lever	Lever	Lever	Lever
16. Stem Construction	inside screw stem	inside screw stem	inside screw stem	inside screw stem
17. Bonnet Construction	union bonnet	union bonnet	union bonnet	union bonnet
18. Product Testing	FAT according manufacturer standard	FAT according manufacturer standard	FAT according manufacturer standard	FAT according manufacturer standard
19. Notes	Device or constructive criterion that avoids accidental disassembly of valve TRIM	Device or constructive criterion that avoids accidental disassembly of valve TRIM	Device or constructive criterion that avoids accidental disassembly of valve TRIM	Device or constructive criterion that avoids accidental disassembly of valve TRIM

Valve Code	VESI-10000-1-D301	VESI-10000-1-D302	VESI-6000-1-S201	VESI-6000-1-S202
Specs	T12	T12	T3	T3
1. Valve Type	Ball valve for instrumentation	Ball valve for instrumentation	Ball valve for instrumentation	Ball valve for instrumentation
2. Sealing Type	Soft	Soft	Soft	Soft
3. Valve Specification Level (VSL)	VSL-1	VSL-1	VSL-1	VSL-1
4. Obturator Type	Floating Ball	Floating Ball	Floating Ball	Floating Ball
5. Valve Standard	Manufacturer Standard	Manufacturer Standard	Manufacturer Standard	Manufacturer Standard
6. Size Range (NPS)	½" - ¾"	½" - ¾"	¼" - 1 ½"	¼" - 1 ½"
7. End Connection	OD tube connection	NPT Female	OD tube connection	NPT Female
8. Pressure Class	max. press 10000 psi	max. press 10000 psi	max. pressure 6000 psi	max. pressure 6000 psi
9. Temperature	0°C to 200°C	0°C to 200°C	0°C to 200°C	0°C to 200°C
10. Material Class	Duplex Steel	Duplex Steel	Stainless Steel	Stainless Steel
11. Body Material	ASTM A182 Gr F55 or ASTM A995 Gr 6a	ASTM A182 Gr F55 or ASTM A995 Gr 6a	ASTM A182 Gr F316	ASTM A182 Gr F316
12. Obturator Material	Super Duplex (UNS S32760)	Super Duplex (UNS S32760)	AISI 316	AISI 316
13. Seat Material	ASTM A276 (UNS S32760)	ASTM A276 (UNS S32760)	ASTM A276 (UNS S31600)	ASTM A276 (UNS S31600)
14. Stem Seal	PTFE	PTFE	PTFE	PTFE
15. Operator Type	Lever	Lever	Lever	Lever
16. Stem Construction	inside screw stem	inside screw stem	inside screw stem	inside screw stem
17. Bonnet Construction	Integral bonnet	Integral bonnet	Integral bonnet	Integral bonnet
18. Product Testing	FAT according manufacturer standard	FAT according manufacturer standard	FAT according manufacturer standard	FAT according manufacturer standard
19. Notes	Device or constructive criterion that avoids accidental disassembly of valve TRIM	Device or constructive criterion that avoids accidental disassembly of valve TRIM	Device or constructive criterion that avoids accidental disassembly of valve TRIM	Device or constructive criterion that avoids accidental disassembly of valve TRIM

Valve Code	VREI-10000-1-D301	VREI-10000-1-D302	VREI-6000-1-S201	VREI-6000-1-S202
Specs	T12	T12	T3	T3
1. Valve Type	Check valve for instrumentation	Check valve for instrumentation	Check valve for instrumentation	Check valve for instrumentation
2. Sealing Type	Metal to Metal	Metal to Metal	Metal to Metal	Metal to Metal
3. Valve Specification Level (VSL)	VSL-1	VSL-1	VSL-1	VSL-1
4. Obturator Type	Manufacturer Standard	Manufacturer Standard	Manufacturer Standard	Manufacturer Standard
5. Valve Standard	Manufacturer Standard	Manufacturer Standard	Manufacturer Standard	Manufacturer Standard
6. Size Range (NPS)	½" - ¾"	½" - ¾"	¼" - 1 ½"	¼" - 1 ½"
7. End Connection	OD tube connection	NPT Female	OD tube connection	NPT Female
8. Pressure Class	max. press 10000 psi	max. press 10000 psi	max. pressure 6000 psi	max. pressure 6000 psi
9. Temperature	0°C to 90°C	0°C to 90°C	0°C to 90°C	0°C to 90°C
10. Material Class	Duplex Steel	Duplex Steel	Stainless Steel	Stainless Steel
11. Body Material	ASTM A182 Gr F55	ASTM A182 Gr F55	ASTM A182 Gr F316	ASTM A182 Gr F316
12. Obturator Material	Super Duplex (UNS S32760)	Super Duplex (UNS S32760)	AISI 316	AISI 316
13. Seat Material	N/A	N/A	N/A	N/A
14. Stem Seal	N/A	N/A	N/A	N/A
15. Operator Type	Not Applicable	Not Applicable	Not Applicable	Not Applicable
16. Stem Construction	Not Applicable	Not Applicable	Not Applicable	Not Applicable
17. Bonnet Construction	Not Applicable	Not Applicable	Not Applicable	Not Applicable
18. Product Testing	FAT according manufacturer standard	FAT according manufacturer standard	FAT according manufacturer standard	FAT according manufacturer standard
19. Notes	Seal material shall be acc. "Group B" Annex A item A.7.1.5.6. Spring material acc. Manufacturer Standard.	Seal material shall be acc. "Group B" Annex A item A.7.1.5.6. Spring material acc. Manufacturer Standard.	Seal material shall be acc. "Group B" Annex A item A.7.1.5.6. Spring material acc. Manufacturer Standard.	Seal material shall be acc. "Group B" Annex A item A.7.1.5.6. Spring material acc. Manufacturer Standard.

ANNEX B

PIPES | FITTINGS | ACCESSORIES (Mandatory)

INDEX

B.1.SCOPE	3
B.2.NORMATIVE REFERENCES	3
B.3.TERMS AND DEFINITIONS	5
B.4.SYMBOLS AND ABBREVIATED TERMS	5
B.5.PIPES AND TUBES	5
B.5.1. IDENTIFICATION CODE	5
B.5.2. GENERAL INFORMATION	5
B.6.FITTINGS	5
B.6.1. IDENTIFICATION CODE	5
B.6.2. GENERAL INFORMATION	7
B.7.NIPPLES	8
B.7.1. IDENTIFICATION CODE	8
B.8.FLANGES	9
B.8.1. IDENTIFICATION CODE	9
B.8.2. GENERAL INFORMATION	10
B.9.GASKETS	10
B.9.1. IDENTIFICATION CODE	10
B.9.2. GENERAL INFORMATION	11
B.10. BOLTS AND NUTS	11
B.10.1. IDENTIFICATION CODE	11
B.10.2. GENERAL INFORMATION	11
B.11. ZINC-NICKEL COATING REQUIREMENTS	12
B.12. ALTERNATIVE MATERIALS	12
B.13. DATASHEETS	13

B.1. SCOPE

This document defines requirements and material data sheets for pipes, fittings, flanges, gaskets and bolts, for use in Exploration and Production (E&P) business area, onshore and offshore, especially in oil and gas production and their process facilities.

B.2. NORMATIVE REFERENCES

Note: The Standards referred herein shall be considered in their latest edition/revision.

ABNT NBR 5648 -Tubos e Conexões de PVC-U com Junta Soldável para Sistemas Prediais de Água Fria;

API SPEC 6A - Specification for Wellhead and Christmas Tree Equipment;

API SPEC 5L - Specification for Line Pipe;

ASME B1.1 - Unified Inch Screw Threads (UN and UNR Thread Form);

ASME B1.20.1 - Pipe Threads, General Purpose (Inch);

ASME B16.1 - Gray Iron Pipe Flanges and Flanged Fittings Classes 25, 125 and 250;

ASME B16.5 - Pipe Flanges and Flanged Fittings NPS 1/2 through NPS 24 Metric/Inch Standard;

ASME B16.9 - Factory-Made Wrought Steel Butt-Welding Fittings;

ASME B16.11 - Forged Fittings, Socket-Welding and Threaded;

ASME B16.14 - Ferrous Pipe Plugs, Bushings and Locknuts with Pipe Threads;

ASME B16.15 - Cast Copper Alloy Threaded Fitting Classes 125 and 250;

ASME B16.20 - Metallic Gaskets for Pipe Flanges Ring-Joint, Spiral-Wound and Jacketed;

ASME B16.21 - Nonmetallic Flat Gaskets for Pipe Flanges;

ASME B16.25 - Buttwelding Ends;

ASME B16.39 - Malleable Iron Threaded Pipe Unions Classes 150, 250 and 300;

ASME B16.47 - Large Diameter Steel Flanges NPS 26 through NPS 60 Metric/Inch Standard;

ASME B18.2.1 - Square, Hex, Heavy Hex, and Askew Head Bolts and Hex, Heavy Hex, Hex Flange, Lobed Head and Lag Screws (Inch Series);

ASME B18.2.2 - Nuts for General Applications: Machine Screw Nuts, Hex, Square, Hex Flange, and Coupling Nuts (Inch Series);

ASME B31.3 - Process Piping;

ASME B31.4 - Pipeline Transportation Systems for Liquid Hydrocarbons and Other Liquids;

ASME B31.8 - Gas Transmission and Distribution Piping Systems;

ASME B36.10 - Welded and Seamless Wrought Steel Pipe;

ASME B36.19 - Stainless Steel Pipe;

ASME BPVC Section VIII, Division I - Rules for Construction of Pressure Vessels;

ASTM A105/A105M - Standard Specification for Carbon Steel Forgings for Piping Applications;

ASTM A126 - Standard Specification for Gray Iron castings for Valves, Flanges, and Pipe Fittings;

ASTM A182/A182M - Standard Specification for Forged or Rolled Alloy and Stainless Steel Pipe Flanges, Forged Fittings, and Valves and Parts for High-Temperature Service;

ASTM A193/A193M - Standard Specification for Alloy-Steel and Stainless Steel Bolting for High Temperature Service or High Pressure Service and other Special Purpose Applications;

ASTM A194/A194M - Standard Specification for Carbon and Alloy Steel Nuts for Bolts for High Pressure or High Temperature Service, or Both;

ASTM A312/A312M - Standard Specification for Seamless, Welded, and Heavily Cold Worked Austenitic Stainless Steel Pipes;

ASTM A320/A320M - Standard Specification for Alloy-Steel and Stainless Steel Bolting for Low-Temperature Service;

ASTM A333/A333M - Standard Specification for Seamless and Welded Steel Pipe for Low-Temperature Service;

ASTM A335/A335M - Standard Specification for Seamless Ferritic Alloy-Steel Pipe for High-Temperature Service;

ASTM A350/A350M - Standard Specification for Carbon and Low-Alloy Steel Forgings, Requiring Notch Toughness Testing for Piping Components;

ASTM A358/A358M - Standard Specification for Electric-Fusion-Welded Austenitic Chromium-Nickel Stainless Steel Pipe for High-Temperature Service and General Applications;

ASTM A671/A671M - Standard Specification for Electric-Fusion-Welded Steel Pipe for Atmospheric and Lower Temperatures;

ASTM A672/A672M - Standard Specification for Electric-Fusion-Welded Steel Pipe for High-Pressure Service at Moderate Temperatures;

ASTM A733 - Standard Specification for Welded and Seamless Carbon Steel and Austenitic Stainless Steel Pipe Nipples;

ASTM B841 - Standard Specification for Electrodeposited Coatings of Zinc Nickel Alloy Deposits

ASTM B849 - Standard Specification for Pre-Treatments of Iron or Steel for Reducing Risk of Hydrogen Embrittlement

ASTM B850 - Standard Guide for Post-Coating Treatments of Steel for Reducing the Risk of Hydrogen Embrittlement

ASTM F 1378 - Standard specification for performance of piping and tubing mechanically attached fittings

ASTM B62 - Standard Specification for Composition Bronze or Ounce Metal Castings;

EEMUA 144 - 90/10 copper nickel alloy piping for offshore applications – specification: tubes seamless and welded

EEMUA 145 - 90/10 copper nickel alloy piping for offshore applications – specification: flanges composite and solid

EEMUA 146 - 90/10 copper nickel alloy piping for offshore applications – specification: fittings

MSS SP-6 - Standard Finishes for Contact Faces of Pipe Flanges and Connecting - End Flanges of Valves and Fittings;

MSS SP-43 - Wrought and Fabricated Butt-Welding Fittings for Low Pressure, Corrosion Resistant Applications;

MSS SP-83 - Class 3 000 Steel Pipe Unions, Socket Welding and Threaded;

MSS SP-95 - Swage (d) Nipples and Bull Plugs;

MSS SP-97 - Integrally Reinforced Forged Branch Outlet Fittings - Socket Welding, Threaded and Buttwelding Ends.

ISO 27509 - Petroleum and natural gas industries – compact flanged connections with IX seal ring

B.3. TERMS AND DEFINITIONS

B.4. SYMBOLS AND ABBREVIATED TERMS

For the purposes of this document, the following symbols and abbreviated terms apply:

B.5. PIPES AND TUBES

B.5.1. IDENTIFICATION CODE

Each pipe datasheet is identify by a code which follow the rule below:

T-XY

Where:

X - Pipe material code, according to Table B.1.

YY - Sequential number.

Table B.1 - Pipe material codes

MATERIAL	CODE X
CARBON STEEL	1
ALLOYS AND ALLOY STEELS	2
STAINLESS STEEL	3
NON METTALICS	4

B.5.2. GENERAL INFORMATION

B.5.2.1. Shall not be used the following diameters (NPS): 3 ½, 5 and 22. NPS 1 ¼ and 2 ½ may be used only in non-metallic piping and fittings.

B.5.2.2. The minimum piping diameter is NPS 1 for organic coat specs (11 and 14 group) in order to minimize flanges connections.

B.5.2.3. The organic coating shall be according to I-ET-3010.1M-1200-956-P4X-002- General Painting.

B.5.2.4. Specs with Inconel cladded pipes shall have monolithic pipes under NPS 4. For NPS 4 and greater the Inconel cladding shall be according to I-ET-3010.1M-1200-955-P4X-001- Welding..

B.5.2.5. The thickness calculation for piggable specs is according to ASME B31.4/B31.8 for NPS equal and greater than NPS 4. Under NPS 4 the thickness is according to ASME B31.3.

B.6. FITTINGS

B.6.1. IDENTIFICATION CODE

Each fitting datasheet is identify by a code which follow the rule below:

CXX.Y-ZZ

Where:

XX - Fitting type, according to Table B.2.

Y - Sequential number to use when necessary.

ZZ - Fitting material codes according to Table B.2.

Table B.2 - Fitting type and material

FITTING TYPE	CODE CXX.Y	FITTING TYPE	CODE CXX.Y
Elbow 90°	C01	Elbow 90° 3D Radius	C35
Elbow 45°	C02	Elbow 90° 5D Radius	C36
Tee	C03	Connector	C37
Reduction Tee	C04	Union Connector	C38
Cross	C05	Stub End type L	C39
Coupling	C06	Elbow 45° - MAF	C40
Half Coupling	C07	Elbow 90° - MAF	C41
Reduction Coupling	C08	Coupling - MAF	C42
Plug	C09	Tee - MAF	C43
Union	C10	Union - MAF	C44
Cap	C11	Cap - MAF	C45
Weldolet	C12	Union – Plain seat type with isolation gasket	C46
Elbow 90° LR (B16.9)	C15	Union – Flexible lug nut type	C47
Elbow 45° LR (B16.9)	C16	45° Tee	C48
Elbow 90° SR (B16.9)	C17	22°30' Elbow	C49
Reduction Concentric (B16.9)	C18	11°15' deg Elbow	C50
Reduction Eccentric (B16.9)	C19	Flanged Saddle	C51
Tee (B16.9)	C20	Threaded Saddle Flg	C52
Reduction Tee (B16.9)	C21	Reduction Cross	C53
Cap (B16.9)	C22	Thredolet	C54
Reduction Bushing	C23	Sockolet	C55
Cross (B16.9)	C24	Reducer Bushing	C56
Elbow 45° 3D Radius	C33		
Elbow 45° 5D Radius	C34		

MATERIAL	CODE ZZ
A105	2
A234 WPB	3
A350 LF2 CI 1	4
A420 WPL6	5
A420 WPL3	11
A182 F316L	14
A403 WP316L	15
API 5L B PSL 1 SML	20
API 5L X65 PSL 2	21
A860 WPHY65	22
A333 8	23
A420 WPL8	24
A522 Tp I	25
A182 F316	26
A182 F51 (UNS S31803)	27
A790 (UNS S31803)	28
A815 (UNS S31803)	29
A182 F55 (UNS S32760)	30
A790 (UNS S32760)	31
A815 (UNS S32760)	32
B366 (UNS N06625)	33
Cu-Ni 70/30	34
Cu-Ni 90/10 (UNS C70620)	35
B62 (UNS C83600)	36
A333 6	37
A312 TP316L	38
B444 1 (UNS N06625)	39
AISI 316	40
PVC	50
CPVC	51
FRP Epoxy vinylester resins (bisphenol A ou brominated) reinforced with fiberglass type E-CR, inner liner with fiberglass veils type C. Suitable for 85°C and 16 bar.	53

MATERIAL	CODE ZZ
FRP Bisphenol A Epoxy resins reinforced with fiberglass type E or E-CR, inner liner with fiberglass veils type C or synthetic organic fibers. Suitable for 90 °C and 10 bar.	54
FRP Bisphenol A Epoxy resins reinforced with fiberglass type E or E-CR, inner liner with fiberglass veils type C or synthetic organic fibers. Suitable for 90 °C and 16 bar.	55
FRP Bisphenol A Epoxy vinylester resins reinforced with fiberglass type E or E-CR, inner liner with fiberglass veils type C or synthetic organic fibers. Suitable for 90 °C and 10 bar.	56
FRP Bisphenol A Epoxy resins reinforced with fiberglass type E or E-CR, inner liner with fiberglass veils type C or synthetic organic fibers. Suitable for 120 °C and 16 bar.	57
RPVC RJ/BS	58
RPVC RJ/SS	59
RPVC EJ/BS	60
FRP Bisphenol A Epoxy vinylester resins reinforced with fiberglass type E or E-CR, inner liner with fiberglass veils type C or synthetic organic fibers. Suitable for 90 °C and 16 bar.	61

B.6.2. GENERAL INFORMATION

- B.6.2.1. Maximum allowed thickness reduction for 3D and 5D pipe bends are 15% and 10%, respectively.
- B.6.2.2. The organic coating shall be according to I-ET-3010.1M-1200-956-P4X-002- General Painting.
- B.6.2.3. The Inconel cladding shall be according to I-ET-3010.1M-1200-955-P4X-001- Welding..

B.7. NIPPLES

B.7.1. IDENTIFICATION CODE

Each nipple datasheet is identify by a code which follow the rule below:

N-XXYY

Where:

XX - Code that identify the relation of nipple types with end type, according to Table B.3.

YY - Nipple material code, according to Table B.3.

Table B.3 – Nipple type and material

CODE XX								
END	PE	BE	TE	BE x PE	BE x TE	MAF	Female TE X Male Capilar	Male TE X Male Capilar
TYPE								
CONCENTRIC	C1	C2	C3	C4	C5	C6	-	-
ECCENTRIC	E1	E2	E3	E4	E5	-	-	-
STRAIGHT	S1	S2	S3	-	-	-	-	-
CONNECTOR	-	-	A3	-	-	-	A7	A8

MATERIAL	CODE
	YY
ASTM A105	2
ASTM A234 Gr WPB	3
ASTM A350 Gr LF2 Cl 1	4
ASTM A420 Gr WPL6	5
ASTM A420 Gr WPL3	11
ASTM A182 Gr F316L	14
ASTM A403 Gr WP316L	15
API 5L Gr B PSL 1 seamless	20
API 5L Gr X65 PSL 2	21
ASTM A860 WPHY65	22
ASTM A333 Gr 8	23
ASTM A420 Gr WPL8	24
ASTM A522 Type I	25
ASTM A182 Gr F316	26
ASTM A182 Gr F51 (UNS S31803)	27
ASTM A790 (UNS S31803)	28
ASTM A815 (UNS S31803)	29
ASTM A182 Gr F55 (UNS S32760)	30
ASTM A790 (UNS S32760)	31
ASTM A815 (UNS S32760)	32

MATERIAL	CODE
	YY
ASTM B366 (UNS N06625)	33
Cu-Ni 70/30	34
Cu-Ni 90/10 (UNS C70620)	35
ASTM B62 (UNS C83600)	36
ASTM A333 Gr 6	37
ASTM A312 TP316L	38
ASTM B444 Gr 1 (UNS N06625)	39
PVC - ASTM D1785 class 1120	50
CPVC - ASTM F441 class 4120	51
RPVC-Glass fiber reinforced PVC	52
Glass fiber reinforced plastic suitable for 70°C and 16 bar	53
Glass fiber reinforced plastic suitable for 90°C and 10 bar	54
Glass fiber reinforced plastic suitable for 90°C and 16 bar	55
Glass fiber reinforced plastic suitable for 120°C and 10 bar	56
Glass fiber reinforced plastic suitable for 120°C and 16 bar	57

B.8. FLANGES

B.8.1. IDENTIFICATION CODE

Each flange datasheet is identify by a code which follow the rule below:

F-class-XY

Where:

Class – Pressure class, according to Table B.4.

X – Code that identify the relation of flange face with flange type, according to Table B.4.

Y – Flange material codes according to Table B.4.

Table B.4 - Codes for flanges

CLASS	
150	ASME B16.5 ou B16.47
300	ASME B16.5 ou B16.47
600	ASME B16.5 ou B16.47
900	ASME B16.5 ou B16.47
1500	ASME B16.5
2500	ASME B16.5 ou ISO 27509
10000	API 6A
20	EEMUA
16	D4024
25	D4024

MATERIAL	CODE Y
ASTM A105 Galvanized	1
ASTM A105	2
ASTM A350 Gr LF2 CL1	3
ASTM A182 Gr F5	4
ASTM A350 Gr LF3	5
ASTM A182 Gr F304L	6
ASTM A182 Gr F316L	7
ASTM A182 Gr F11	8
ASTM A182 Gr F317L	9
ASTM A182 Gr F347	A
ASTM A105 with cladde	B
ASTM A694 Gr F65	C
ASTM A694 Gr F65 cladde	D
ASTM A350 Gr LF3 cladde	E
ASTM A182 Gr F316	F
ASTM A182 Gr F51	G
ASTM A182 Gr F55	H
ASTM A522 Type 1	J
ASTM A522 Tipo 1 cladde	K
ASTM B564	L
Cu-Ni 90/10	M
Cu-Ni 70/30	N
PVC	P
CVPC	Q
RPVC	R
FRP 70°C	S
FRP 90°C	T
FRP 120°C	U

CODE X											
Face Type	Flange type										
	THD	SO	SW	WN	BL	OR	RJ	EJ	BF	MAF	INT
FF	A	B	C	D	E	F	W	X			1
RF	G	H	J	K	L	M			Y	Z	
RTJ	N	P	Q	R	S	T					
MSJ				U	V						

B.8.2. GENERAL INFORMATION

B.8.2.1. The organic coating shall be according to I-ET-3010.1M-1200-956-002 - General Painting.

B.8.2.2. The Inconel cladding shall be according to I-ET-3010.1M-1200-955-P4X-001- Welding.

B.8.2.3. The composite welding neck flange is according to EEMUA 145, composed of a backing flange and a stub end type L. The backing flange shall be epoxy coated following annex F recommendations.

B.9. GASKETS

B.9.1. IDENTIFICATION CODE

Each Gasket datasheet is identify by a code which follow the rule below:

J-class-XY

Where:

Class – Pressure class, according to Table B.5.

X – Code that identify the relation of flange face with gasket type, according to Table B.5.

Y – Flange material codes according to Table B.5.

Table B.5 - Codes for gaskets

Flange Standard	Class
ASME B16.1	125
ASME B16.5 and ASME B16.47	150
	300
	600
	900
	1500
ASME B16.5 / ISO 27509	2500
API 6A	10000

CODE X				
Gasket type	Face type			
	FP	FR	FJA	MSJ
Flat	C	P		
Spiral Wound		E		
Ring Joint			A	B
Grooved		G		
Isolation	D	F	H	

MATERIAL	FILLER	Inner Ring	Centering Ring	Facing layer	CODE Y
Aramide Fiber	-	-	-	-	A
Neoprene	-	-	-	-	B
PTFE expanded	-	-	-	-	C
SBR	-	-	-	-	D
AISI 304	Graphite	AISI 304	Carbon steel	-	E
AISI 316	Graphite	AISI 316	Carbon steel	-	F
AISI 316	Graphite	AISI 317	Carbon steel	-	G
AISI 316	Graphite	AISI 316	AISI 316	-	H
AISI 347	Graphite	-	Carbon steel	-	J
MONEL	PTFE	MONEL	Carbon steel	-	K
Duplex	Graphite	Duplex	AISI 316	-	L
Inconel 625	Graphite	Inconel 625	AISI 316	-	M
Carbon Steel	-	-	-	-	N
A182 F5	-	-	-	-	P
A182 F11	-	-	-	-	Q
A182 F347	-	-	-	-	R
AISI 304	-	-	-	-	S
AISI 316	-	-	-	-	T
A182 F51	-	-	-	-	U
Inconel 625	-	-	-	-	V
A522 TP I	-	-	-	-	W
AISI 316	-	-	-	PTFE	X
Phenolic	-	-	-	Nitrile Rubber	Y
AISI 316	-	-	-	G10	Z

B.9.2. GENERAL INFORMATION

B.9.2.1. The Zinc-Nickel coating indicated in gaskets datasheets shall be according to item B.11.

B.9.2.2. Electric isolation gasket shall be according to Annex E.

B.10. BOLTS AND NUTS

B.10.1. IDENTIFICATION CODE

Each Bolt and nut datasheet, is identify by a code which follow the rule below:

P-class-XX

Where:

Class – Flange pressure class

XX - Sequential number.

Table B.6 - Codes for Bolts and Nuts

BOLT MATERIAL	NUT MATERIAL	CODE XX
ASTM A193 Gr. B7	ASTM A194 Gr. 2H	01
ASTM A320 Gr. L7	ASTM A194 Gr. 4L	02
ASTM A 193 Gr. B7, revestido em Zn-Ni	ASTM A 194 Gr. 2H, revestido em Zn-Ni	07
ASTM A 320 Gr. L7, revestido em Zn-Ni	ASTM A 194 Gr. 4L, revestido em Zn-Ni	08
ASTM A320 Gr. L43, revestido em Zn-Ni	ASTM A194 Gr. 4L, revestido em Zn-Ni	09

B.10.2. GENERAL INFORMATION

B.10.2.1. The studs, bolts and nuts shall be coated with zinc-nickel (Zn-Ni) according to item B.11.

B.11. ZINC-NICKEL COATING REQUIREMENTS

B.11.1. The procedure for bolts, nuts, washers and gaskets Zn-Ni coating shall be in accordance with ASTM B841 standard and the deposit classification is as follow:

- a) Class 1
- b) Type B and E
- c) ASTM Grade 8

B.11.2. ASTM B 850-98 – A table is presented containing temperature and thermal treatment time with relation to the steel's resistance limit. Steel with a resistance limit over 1000Mpa should be thermally treated to remove hydrogen following the electrodeposition (from between 1 hour to a maximum 3 hours following electrodeposition). The thermal treatment is performed prior to the chroming at 190°C for 3 to 4 hours. Evidence of the applied treatment should be presented (Graphs).

B.11.3. ASTM B 849-02 - Contains a description of the thermal treatment procedures (when applicable) used before the operations which could bring about hydrogen loading, such as cleaning procedures, electrodeposition.

B.11.4. Final Inspection – The layer should be inspected with a micrometer, deltascope or radiograph.

The alloy should be inspected by spectrophotometer or radiograph.

Note: An alkaline bath should preferably be used.

B.12. ALTERNATIVE MATERIALS

B.12.1. All materials listed in pipe specs shall be considered as standardized materials. Therefore, alternative materials (equivalent or better) may be proposed, conditioned to PETROBRAS approval.

B.12.2. When substitutions were made shall be verified the wall thickness and the piping spec shall be updated.

B.12.3. Other alternative materials may be acceptable subject to Petrobras approval

B.12.4. Some examples of alternative materials are in Table B.7

Table B.7 – Alternative Materials

Standardized material	Alternative material
API 5L Gr B	ASTM A 106 Gr B
API 5L Gr B	API 5L Gr X65 PSL 2
API 5L Gr B	ASTM A333 GR 6
Super duplex UNS S32760	Super duplex UNS S32750
Duplex UNS 31803	Super duplex UNS S32760 or UNS S32750
ASTM A105	ASTM A350 LF2
ASTM A234 WPB	ASTM A420 WPL6

B.13. DATASHEETS

1. PIPES

PIPE

Commodity Code	T-102		T-105		T-106	
Specs	B4 B9 B10 B11 B14 B30 C4 C8 C9 C10 C11 C30 E8 E9 E10 F10 G10P H10 R9B R9C S9B S9C		B6 B19 C6 C19 E6 E19 F6 H6		B6 B19 C6 C19 E6 E19 F6 H6	
1. Item	Pipe		Pipe		Pipe	
2. Material	API 5L Gr B PSL 1		ASTM A333 Gr 6		ASTM A671 Gr CC60 Class 22	
3. Standard	ASME B36.10		ASME B36.10		ASME B36.10	
4. Schedule (SCH) or thickness	-		-		-	
5. Ends	½" - 1 ½"	NPT Threaded End , Plain End	½" - 1 ½"	Plain End	Beveled End	
	2" - 44"	Beveled End	2" - 28"	Beveled End	-	
6. Seam type	½" - 1 ½"	Seamless	½" - 10"	Seamless	2" - 14"	Seamless
	2" - 14"	HFW , SAW , Seamless	12" - 14"	Seamless , Welded	16" - 36"	Welded
	16" - 24"	HFW , SAW	16" - 28"	Welded	-	
	26" - 44"	SAW	-		-	
7. Size Range (NPS)	½" - 44"		½" - 28"		2" - 36"	
8. Additional requirement	-		-		-	

Commodity Code	T-107		T-202		T-203	
Specs	E9 E10 E30 F10 G10P H10 H30P H30		B7R B7 S7		B30 C30 E30 E32 H30P H30 J40P J40	
1. Item	Pipe		Pipe		Pipe	
2. Material	API 5L Gr X65 PSL 2		Cu-Ni 90/10 (UNS C70620)		ASTM B444 Gr 1 (UNS N06625)	
3. Standard	ASME B36.10		EEMUA 234		ASME B36.10/B36.19	
4. Schedule (SCH) or thickness	-		-		-	
5. Ends	1" - 1 ½"	Plain End	½" - 2"	Plain End	½" - 1 ½"	Plain End
	2" - 34"	Beveled End	2 ½" - 36"	Beveled End	2" - 14"	Beveled End
6. Seam type	1" - 1 ½"	Seamless	½" - 4"	Seamless	Seamless	
	2" - 14"	SAW , Seamless	6" - 16"	Seamless , Welded	-	
	16" - 34"	SAW	18" - 36"	Welded	-	
7. Size Range (NPS)	1" - 34"		½" - 36"		½" - 14"	
8. Additional requirement	-		-		-	

Commodity Code	T-211		T-301		T-302	
Specs	E32		B16 C16 E16 H16		B16 C16 E16 H16	
1. Item	Pipe		Pipe		Pipe	
2. Material	ASTM A333 Gr 3		ASTM A790 (UNS S31803)		ASTM A928 (UNS S31803 Cl 1 or 3)	
3. Standard	ASME B36.10		ASME B36.10/B36.19		ASME B36.10/B36.19	
4. Schedule (SCH) or thickness	-		-		-	
5. Ends	Beveled End		½" - 1 ½"	Plain End	Beveled End	
	-		2" - 14"	Beveled End	-	
6. Seam type	4" - 6"	HFW , Seamless	½" - 8"	Seamless	Welded	
	8" - 14"	Seamless	10" - 14"	Welded	-	
	16"	Welded	-		-	
7. Size Range (NPS)	4" - 16"		½" - 14"		10" - 34"	
8. Additional requirement	-		-		-	

Commodity Code	T-303		T-304		T-319	
Specs	B12 C12 H12P H12 J12P J12		B12 C12 H12P H12 J12P J12		T3	
1. Item	Pipe		Pipe		Pipe	
2. Material	ASTM A790 (UNS S32760)		ASTM A928 (UNS S32760 Cl 1 or 3)		ASTM A269 Type 316/316L, hardness <= 80 HRB	
3. Standard	ASME B36.10/B36.19		ASME B36.10/B36.19		-	
4. Schedule (SCH) or thickness	-		-		-	
5. Ends	½" - 1 ½"	Plain End	½" - 1 ½"	Plain End	Plain End	
	2" - 8"	Beveled End	2" - 48"	Beveled End	-	
6. Seam type	Seamless		½" - 8"	Seamless	Seamless	
	8"	Welded	10" - 48"	Welded	-	
7. Size Range (NPS)	½" - 8"		½" - 48"		¾" - 1 ½"	
8. Additional requirement	-		-		-	

Commodity Code	T-321		T-322		T-323
Specs	B50		B3 C3 E3 F3 G3 H3 R3B R3C S3B S3C		B3 C3 E3 F3 G3 H3 R3B R3C
1. Item	Pipe		Pipe		Pipe
2. Material	ASTM A312 TP 310H		ASTM A312 TP 316/316L		ASTM A358 Type 316/316L Cl 1 or 3
3. Standard	ASME B36.19		ASME B36.19		ASME B36.10/B36.19
4. Schedule (SCH) or thickness	-		-		-
5. Ends	½" - 1 ½"	Plain End	½" - 1 ½"	Plain End	Beveled End
	2" - 56"	Beveled End	2" - 6"	Beveled End	
6. Seam type	½" - 1 ½"	Seamless	½" - 1 ½"	Seamless	Welded
	2" - 56"	Welded	2" - 6"	Welded	
7. Size Range (NPS)	½" - 56"		½" - 6"		2" - 40"
8. Additional requirement	-		-		-

Commodity Code	T-324	T-401	T-402
Specs	T12	B20	B21
1. Item	Pipe	Pipe	Pipe
2. Material	ASTM A789 (UNS S32760)	PVC - ASTM D1785 class 1120	CPVC - Chlorinated polyvinyl chloride, ASTM F441 4120
3. Standard	-	ASTM D1785	ASTM F441
4. Schedule (SCH) or thickness	-	-	-
5. Ends	Plain End	Plain End	Plain End
6. Seam type	Seamless	Seamless	Seamless
7. Size Range (NPS)	½" - ¾"	½" - 8"	½" - 8"
8. Additional requirement	-	-	-

Commodity Code	T-404	T-405	T-406
Specs	B22		B23
1. Item	Pipe	Pipe	Pipe
2. Material	FRP - Bisphenol A Epoxy resins reinforced with fiberglass type E or E-CR. Design pressure 10 bar@90°C.	FRP - Bisphenol A Epoxy vinylester resins reinforced with fiberglass type E or E-CR. Design pressure 10 bar@90°C.	FRP - Bisphenol A Epoxy resins reinforced with fiberglass type E or E-CR. Design pressure 16 bar@90°C.
3. Standard	ISO 14692	ISO 14692	ISO 14692
4. Schedule (SCH) or thickness	-	-	-
5. Ends	Bell-Spigot, Butt-Strap	-	Bell-Spigot, Butt-Strap
6. Seam type	Seamless	-	Seamless
7. Size Range (NPS)	1" - 40"	-	1" - 46"
8. Additional requirement	-	-	-

Commodity Code	T-407	T-408	T-409
Specs		B26	B27
1. Item	Pipe	Pipe	Pipe
2. Material	FRP - Bisphenol A Epoxy vinylester resins reinforced with fiberglass type E or E-CR. Design pressure 16 bar@90°C.	FRP - Bisphenol A Epoxy resins reinforced with fiberglass type E or E-CR. Design pressure 16 bar@120°C.	FRP - Epoxy vinylester resins (bisphenol A brominated) reinforced with fiberglass type E-CR, inner liner with fiberglass veils type C. Design pressure 16 bar@85°C.
3. Standard	ISO 14692	ISO 14692	ISO 14692
4. Schedule (SCH) or thickness	-	-	-
5. Ends	-	Bell-Spigot, Butt-Strap	Bell-Spigot, Butt-Strap
6. Seam type	-	Seamless	Seamless
7. Size Range (NPS)	-	1" - 36"	1" - 6"
8. Additional requirement	-	-	-

Commodity Code	T-410
Specs	C23
1. Item	Pipe
2. Material	FRP - Bisphenol A Epoxy resins reinforced with fiberglass type E or E-CR. Design pressure 25 bar@90°C.
3. Standard	ISO 14692
4. Schedule (SCH) or thickness	-
5. Ends	Bell-Spigot, Butt-Strap
6. Seam type	Seamless
7. Size Range (NPS)	1" - 28"
8. Additional requirement	-

2. FITTINGS

B12.2.1 5D 45 DEG PIPE BEND

Commodity Code	!! EXISTING !! C34-39 ID155040	C34-21	C34-31
Specs		G10P H30P	H12P J12P
1. Fitting type	5D 45 deg Pipe Bend	5D 45 deg Pipe Bend	5D 45 deg Pipe Bend
2. Material	ASTM B444 Gr 1 (UNS N06625)	API 5L Gr X65 PSL 2	ASTM A790 (UNS S32760)
3. Standard	according to manufacturer	according to manufacturer	according to manufacturer
4. Pressure class or thickness	-	-	-
5. End connections	Beveled end	Beveled end	Beveled end
6. Size Range (NPS)	-	4" - 34"	2" - 18"
7. Additional requirement	-	-	-

Commodity Code	C34-39	C34-41	C34-46
Specs	J40P	H12P J12P	
1. Fitting type	5D 45 deg Pipe Bend	5D 45 deg Pipe Bend	5D 45 deg Pipe Bend
2. Material	ASTM B444 Gr 1 (UNS N06625)	ASTM A928 (UNS S32760 Cl 1 or 3)	ASTM A358 TP316/316L
3. Standard	according to manufacturer	according to manufacturer	according to manufacturer
4. Pressure class or thickness	-	-	-
5. End connections	Beveled end	Beveled end	Beveled end
6. Size Range (NPS)	4" - 14"	10" - 18"	-
7. Additional requirement	-	-	-

B12.2.2 5D 90 DEG PIPE BEND

Commodity Code	!! EXISTING !! C36-39 ID155044	C36-21	C36-31
Specs		G10P H30P	H12P J12P
1. Fitting type	5D 90 deg Pipe Bend	5D 90 deg Pipe Bend	5D 90 deg Pipe Bend
2. Material	ASTM B444 Gr 1 (UNS N06625)	API 5L Gr X65 PSL 2	ASTM A790 (UNS S32760)
3. Standard	according to manufacturer	according to manufacturer	according to manufacturer
4. Pressure class or thickness	-	-	-
5. End connections	Beveled end	Beveled end	Beveled end
6. Size Range (NPS)	-	4" - 34"	4" - 8"
7. Additional requirement	-	-	-

Commodity Code	C36-39	C36-41	C36-46
Specs	J40P	H12P J12P	
1. Fitting type	5D 90 deg Pipe Bend	5D 90 deg Pipe Bend	5D 90 deg Pipe Bend
2. Material	ASTM B444 Gr 1 (UNS N06625)	ASTM A928 (UNS S32760 Cl 1 or 3)	ASTM A358 TP316/316L
3. Standard	according to manufacturer	according to manufacturer	according to manufacturer
4. Pressure class or thickness	-	-	-
5. End connections	Beveled end	Beveled end	Beveled end
6. Size Range (NPS)	4" - 14"	10" - 18"	-
7. Additional requirement	-	-	-

B12.2.3 90 DEG ELBOW, B16.11

Commodity Code	C01-02	C01-04	C01-24
Specs	B4 B9 B10 C4 C8 C9 C10 E8 E9 E10 F10 G10P	B6 B19 C6 C19 E6 E19 F6	
1. Fitting type	90 deg Elbow, B16.11	90 deg Elbow, B16.11	90 deg Elbow, B16.11
2. Material	ASTM A105	ASTM A350 Gr LF2 Cl 1	ASTM A420 Gr WPL8
3. Standard	ASME B16.11	ASME B16.11	ASME B16.11
4. Pressure class or thickness	3000 ½" - 1 ½"	3000, 6000, 9000	-
5. End connections	NPT Threaded End	Socket Weld	-
	½" - 1 ½" Socket Weld	-	-
6. Size Range (NPS)	½" - 2"	½" - 1 ½"	-
7. Additional requirement	-	-	-

Commodity Code	C01-27	C01-30	C01-33
Specs	B16 C16 E16	B12 C12	B30 C30 E30 E32
1. Fitting type	90 deg Elbow, B16.11	90 deg Elbow, B16.11	90 deg Elbow, B16.11
2. Material	ASTM A182 Gr F51 (UNS S31803)	ASTM A182 Gr F55 (UNS S32760)	ASTM B366 (UNS N06625)
3. Standard	ASME B16.11	ASME B16.11	ASME B16.11
4. Pressure class or thickness	3000	3000	3000
5. End connections	Socket Weld	Socket Weld	Socket Weld
6. Size Range (NPS)	½" - 1 ½"	½" - 1 ½"	½" - 1 ½"
7. Additional requirement	-	-	-

Commodity Code	C01-35	C01-43	C01-50
Specs	B7R B7	B3 C3 E3 F3 G3	B20
1. Fitting type	90 deg Elbow, B16.11	90 deg Elbow, B16.11	90 deg Elbow, B16.11
2. Material	Cu-Ni 90/10 (UNS C70620)	ASTM A182 Gr F316/316L	PVC - ASTM D1784 class 12454
3. Standard	EEMUA 234	ASME B16.11	ASTM D2467
4. Pressure class or thickness	20 bar	3000	-
5. End connections	Female Capilar	Socket Weld	Socket ½" - 2" Socket x Female Thread
6. Size Range (NPS)	½" - 1 ½"	½" - 1 ½"	½" - 8"
7. Additional requirement	-	-	-

Commodity Code	C01-51	C01-62
Specs	B21	B50
1. Fitting type	90 deg Elbow, B16.11	90 deg Elbow, B16.11
2. Material	CPVC - ASTM D1784 class 23447	ASTM A182 Gr F310H
3. Standard	ASTM F439	ASME B16.11
4. Pressure class or thickness	-	3000
5. End connections	Socket	Socket Weld
6. Size Range (NPS)	½" - 8"	½" - 1 ½"
7. Additional requirement	-	-

B12.2.4 45 DEG ELBOW, B16.11

Commodity Code	C02-02	C02-04	C02-27
Specs	B4 B9 B10 C4 C8 C9 C10 E8 E9 E10 F10 G10P	B6 B19 C6 C19 E6 E19 F6	B16 C16 E16
1. Fitting type	45 deg Elbow, B16.11	45 deg Elbow, B16.11	45 deg Elbow, B16.11
2. Material	ASTM A105	ASTM A350 Gr LF2 Cl 1	ASTM A182 Gr F51 (UNS S31803)
3. Standard	ASME B16.11	ASME B16.11	ASME B16.11
4. Pressure class or thickness	3000, 6000, 9000	3000, 6000, 9000	3000
5. End connections	NPT Threaded End , Socket Weld	Socket Weld	Socket Weld
6. Size Range (NPS)	½" - 1 ½"	½" - 1 ½"	½" - 1 ½"
7. Additional requirement	-	-	-

Commodity Code	C02-30	C02-33	C02-35
Specs	B12 C12	B30 C30 E30 E32	B7R B7
1. Fitting type	45 deg Elbow, B16.11	45 deg Elbow, B16.11	45 deg Elbow, B16.11
2. Material	ASTM A182 Gr F55 (UNS S32760)	ASTM B366 (UNS N06625)	Cu-Ni 90/10 (UNS C70620)
3. Standard	ASME B16.11	ASME B16.11	EEMUA 234
4. Pressure class or thickness	3000	3000	20 bar
5. End connections	Socket Weld	Socket Weld	Female Capilar
6. Size Range (NPS)	½" - 1 ½"	½" - 1 ½"	½" - 1 ½"
7. Additional requirement	-	-	-

Commodity Code	C02-43	C02-50	C02-51
Specs	B3 C3 E3 F3 G3	B20	B21
1. Fitting type	45 deg Elbow, B16.11	45 deg Elbow, B16.11	45 deg Elbow, B16.11
2. Material	ASTM A182 Gr F316/316L	PVC - ASTM D1784 class 12454	CPVC - ASTM D1784 class 23447
3. Standard	ASME B16.11	ASTM D2467	ASTM F439
4. Pressure class or thickness	3000	-	-
5. End connections	Socket Weld	Socket	Socket
6. Size Range (NPS)	½" - 1 ½"	½" - 8"	½" - 8"
7. Additional requirement	-	-	-

Commodity Code	C02-62
Specs	B50
1. Fitting type	45 deg Elbow, B16.11
2. Material	ASTM A182 Gr F310H
3. Standard	ASME B16.11
4. Pressure class or thickness	3000
5. End connections	Socket Weld
6. Size Range (NPS)	½" - 1 ½"
7. Additional requirement	-

B12.2.5 TEE, B16.11

Commodity Code	C03-02	C03-04	C03-27
Specs	B4 B9 B10 C4 C8 C9 C10 E8 E9 E10 F10 G10P	B6 B19 C6 C19 E6 E19 F6	B16 C16 E16
1. Fitting type	Tee, B16.11	Tee, B16.11	Tee, B16.11
2. Material	ASTM A105	ASTM A350 Gr LF2 Cl 1	ASTM A182 Gr F51 (UNS S31803)
3. Standard	ASME B16.11	ASME B16.11	ASME B16.11
4. Pressure class or thickness	3000, 6000 ¾" - 1 ½" 9000	3000, 6000, 9000	3000
5. End connections	NPT Threaded End , Socket Weld	Socket Weld	Socket Weld
6. Size Range (NPS)	½" - 1 ½"	½" - 1 ½"	½" - 1 ½"
7. Additional requirement	-	-	-

Commodity Code	C03-30	C03-33	C03-35
Specs	B12 C12	B30 C30 E30 E32	B7R B7
1. Fitting type	Tee, B16.11	Tee, B16.11	Tee, B16.11
2. Material	ASTM A182 Gr F55 (UNS S32760)	ASTM B366 (UNS N06625)	Cu-Ni 90/10 (UNS C70620)
3. Standard	ASME B16.11	ASME B16.11	EEMUA 234
4. Pressure class or thickness	3000	3000	20 bar
5. End connections	Socket Weld	Socket Weld	Female Capilar
6. Size Range (NPS)	½" - 1 ½"	½" - 1 ½"	½" - 1 ½"
7. Additional requirement	-	-	-

Commodity Code	C03-43	C03-50	C03-51
Specs	B3 C3 E3 F3 G3	B20	B21
1. Fitting type	Tee, B16.11	Tee, B16.11	Tee, B16.11
2. Material	ASTM A182 Gr F316/316L	PVC - ASTM D1784 class 12454	CPVC - ASTM D1784 class 23447
3. Standard	ASME B16.11	ASTM D2467	ASTM F439
4. Pressure class or thickness	3000	-	-
5. End connections	Socket Weld	Socket	Socket
6. Size Range (NPS)	½" - 1 ½"	½" - 8"	½" - 8"
7. Additional requirement	-	-	-

Commodity Code	C03-62
Specs	B50
1. Fitting type	Tee, B16.11
2. Material	ASTM A182 Gr F310H
3. Standard	ASME B16.11
4. Pressure class or thickness	3000
5. End connections	Socket Weld
6. Size Range (NPS)	½" - 1 ½"
7. Additional requirement	-

B12.2.6 REDUCING TEE, B16.11

Commodity Code	C04-02	C04-04	C04-27
Specs	B4 B9 B10 C4 C8 C9 C10 E8 E9 E10 F10 G10P	B6 B19 C6 C19 E6 E19 F6	B16 C16 E16
1. Fitting type	Reducing Tee, B16.11	Reducing Tee, B16.11	Reducing Tee, B16.11
2. Material	ASTM A105	ASTM A350 Gr LF2 Cl 1	ASTM A182 Gr F51 (UNS S31803)
3. Standard	ASME B16.11	ASME B16.11	ASME B16.11
4. Pressure class or thickness	3000, 6000, 9000	3000, 6000, 9000	3000
5. End connections	NPT Threaded End , Socket Weld	Socket Weld	Socket Weld
6. Size Range (NPS)	¾" - 1 ½"	¾" - 1 ½"	¾" - 1 ½"
7. Additional requirement	-	-	-

Commodity Code	C04-30	C04-33	C04-35
Specs	B12 C12	B30 C30 E30 E32	
1. Fitting type	Reducing Tee, B16.11	Reducing Tee, B16.11	Reducing Tee, B16.11
2. Material	ASTM A182 Gr F55 (UNS S32760)	ASTM B366 (UNS N06625)	Cu-Ni 90/10 (UNS C70620)
3. Standard	ASME B16.11	ASME B16.11	EEMUA 234
4. Pressure class or thickness	3000	3000	-
5. End connections	Socket Weld	Socket Weld	-
6. Size Range (NPS)	¾" - 1 ½"	¾" - 1 ½"	-
7. Additional requirement	-	-	-

Commodity Code	C04-43	C04-62
Specs	B3 C3 E3 F3 G3	B50
1. Fitting type	Reducing Tee, B16.11	Reducing Tee, B16.11
2. Material	ASTM A182 Gr F316/316L	ASTM A182 Gr F310H
3. Standard	ASME B16.11	ASME B16.11
4. Pressure class or thickness	3000	3000
5. End connections	Socket Weld	Socket Weld
6. Size Range (NPS)	¾" - 1 ½"	¾" - 1 ½"
7. Additional requirement	-	-

B12.2.7 CROSS, B16.11

Commodity Code	C05-02	C05-04	C05-27
Specs	B4 B9 B10 C4 C8 C9 C10 E8 E9 E10 F10 G10P	B6 B19 C6 C19 E6 E19 F6	B16 C16 E16
1. Fitting type	Cross, B16.11	Cross, B16.11	Cross, B16.11
2. Material	ASTM A105	ASTM A350 Gr LF2 Cl 1	ASTM A182 Gr F51 (UNS S31803)
3. Standard	ASME B16.11	ASME B16.11	ASME B16.11
4. Pressure class or thickness	3000, 6000, 9000	3000, 6000, 9000	3000
5. End connections	NPT Threaded End , Socket Weld	Socket Weld	Socket Weld
6. Size Range (NPS)	½" - 1 ½"	½" - 1 ½"	½" - 1 ½"
7. Additional requirement	-	-	-

Commodity Code	C05-30	C05-33	C05-43
Specs	B12 C12	B30 C30 E30 E32	B3 C3 E3 F3 G3
1. Fitting type	Cross, B16.11	Cross, B16.11	Cross, B16.11
2. Material	ASTM A182 Gr F55 (UNS S32760)	ASTM B366 (UNS N06625)	ASTM A182 Gr F316/316L
3. Standard	ASME B16.11	ASME B16.11	ASME B16.11
4. Pressure class or thickness	3000	3000	3000
5. End connections	Socket Weld	Socket Weld	Socket Weld
6. Size Range (NPS)	½" - 1 ½"	½" - 1 ½"	½" - 1 ½"
7. Additional requirement	-	-	-

Commodity Code	C05-62
Specs	B50
1. Fitting type	Cross, B16.11
2. Material	ASTM A182 Gr F310H
3. Standard	ASME B16.11
4. Pressure class or thickness	3000
5. End connections	Socket Weld
6. Size Range (NPS)	½" - 1 ½"
7. Additional requirement	-

B12.2.8 COUPLING

Commodity Code	C06-02	C06-04	C06-27
Specs	B4 B9 B10 C4 C8 C9 C10 E8 E9 E10 F10 G10P	B6 B19 C6 C19 E6 E19 F6	B16 C16 E16
1. Fitting type	Coupling	Coupling	Coupling
2. Material	ASTM A105	ASTM A350 Gr LF2 Cl 1	ASTM A182 Gr F51 (UNS S31803)
3. Standard	ASME B16.11	ASME B16.11	ASME B16.11
4. Pressure class or thickness	3000, 6000, 9000	3000, 6000, 9000	3000
5. End connections	NPT Threaded End , Socket Weld	Socket Weld	Socket Weld
6. Size Range (NPS)	½" - 1 ½"	½" - 1 ½"	½" - 1 ½"
7. Additional requirement	-	-	-

Commodity Code	C06-30	C06-33	C06-35
Specs	B12 C12	B30 C30 E30 E32	B7R B7
1. Fitting type	Coupling	Coupling	Coupling
2. Material	ASTM A182 Gr F55 (UNS S32760)	ASTM B366 (UNS N06625)	Cu-Ni 90/10 (UNS C70620)
3. Standard	ASME B16.11	ASME B16.11	EEMUA 234
4. Pressure class or thickness	3000	3000	20 bar
5. End connections	Socket Weld	Socket Weld	Female Capilar
6. Size Range (NPS)	½" - 1 ½"	½" - 1 ½"	½" - 1 ½"
7. Additional requirement	-	-	-

Commodity Code	C06-43	C06-50	C06-51
Specs	B3 C3 E3 F3 G3	B20	B21
1. Fitting type	Coupling	Coupling	Coupling
2. Material	ASTM A182 Gr F316/316L	PVC - ASTM D1784 class 12454	CPVC - ASTM D1784 class 23447
3. Standard	ASME B16.11	ASTM D2467	ASTM F439
4. Pressure class or thickness	3000	-	-
5. End connections	Socket Weld	Socket	Socket
6. Size Range (NPS)	½" - 1 ½"	½" - 8"	½" - 8"
7. Additional requirement	-	-	-

Commodity Code	C06-52	C06-53	C06-54
Specs	B22		B23
1. Fitting type	Coupling	Coupling	Coupling
2. Material	FRP - Bisphenol A Epoxy resins reinforced with fiberglass type E or E-CR. Design pressure 10bar@90°C	FRP - Bisphenol A Epoxy vinylester resins reinforced with fiberglass type E or E-CR. Design pressure 10bar@90°C.	FRP - Bisphenol A Epoxy resins reinforced with fiberglass type E or E-CR. Design pressure 16bar@90°C
3. Standard	ISO 14692	ISO 14692	ISO 14692
4. Pressure class or thickness	10 bar	-	16 bar
5. End connections	Bell-Spigot	-	Bell-Spigot
6. Size Range (NPS)	1" - 40"	-	1" - 46"
7. Additional requirement	-	-	-

Commodity Code	C06-55	C06-56	C06-57
Specs		B26	B27
1. Fitting type	Coupling	Coupling	Coupling
2. Material	FRP - Bisphenol A Epoxy vinylester resins reinforced with fiberglass type E or E-CR. Design pressure 16bar@90°C.	FRP - Bisphenol A Epoxy resins reinforced with fiberglass type E or E-CR. Design pressure 16bar@120°C	FRP - Epoxy vinylester resins (bisphenol A or brominated) reinforced with fiberglass type E-CR, inner liner with fiberglass veils type C. Design pressure 16bar@85°C
3. Standard	ISO 14692	ISO 14692	ISO 14692
4. Pressure class or thickness	-	16 bar	16 bar
	-	1" - 16" 10 bar, 25 bar	-
5. End connections	-	Bell-Spigot	Bell-Spigot
	-	1" - 16" Butt-Strap	-
6. Size Range (NPS)	-	1" - 36"	1" - 6"
7. Additional requirement	-	-	-

Commodity Code	C06-62	C06-64
Specs	B50	C23
1. Fitting type	Coupling	Coupling
2. Material	ASTM A182 Gr F310H	FRP - Bisphenol A Epoxy resins reinforced with fiberglass type E or E-CR. Design pressure 25bar@90°C
3. Standard	ASME B16.11	ISO 14692
4. Pressure class or thickness	3000	25 bar
	-	1" - 6" 16 bar
5. End connections	Socket Weld	Bell-Spigot
6. Size Range (NPS)	½" - 1 ½"	1" - 28"
7. Additional requirement	-	-

B12.2.9 HALF COUPLING, B16.11

Commodity Code	C07-43	C07-50	C07-51
Specs			
1. Fitting type	Half Coupling, B16.11	Half Coupling, B16.11	Half Coupling, B16.11
2. Material	ASTM A182 Gr F316/316L	PVC - ASTM D1784 class 12454	CPVC - ASTM D1784 class 23447
3. Standard	ASME B16.11	ASTM D2464	ASTM F439
4. Pressure class or thickness	-	-	-
5. End connections	-	-	-
6. Size Range (NPS)	-	-	-
7. Additional requirement	-	-	-

Commodity Code	C07-52	C07-53	C07-54
Specs			
1. Fitting type	Half Coupling, B16.11	Half Coupling, B16.11	Half Coupling, B16.11
2. Material	FRP - Bisphenol A Epoxy resins reinforced with fiberglass type E or E-CR. Design pressure 10bar@90°C	FRP - Bisphenol A Epoxy vinylester resins reinforced with fiberglass type E or E-CR. Design pressure 10bar@90°C.	FRP - Bisphenol A Epoxy resins reinforced with fiberglass type E or E-CR. Design pressure 16bar@90°C
3. Standard	ISO 14692	ISO 14692	ISO 14692
4. Pressure class or thickness	-	-	-
5. End connections	-	-	-
6. Size Range (NPS)	-	-	-
7. Additional requirement	-	-	-

Commodity Code	C07-55	C07-56	C07-57
Specs			
1. Fitting type	Half Coupling, B16.11	Half Coupling, B16.11	Half Coupling, B16.11
2. Material	FRP - Bisphenol A Epoxy vinylester resins reinforced with fiberglass type E or E-CR. Design pressure 16bar@90°C.	FRP - Bisphenol A Epoxy resins reinforced with fiberglass type E or E-CR. Design pressure 16bar@120°C	FRP - Epoxy vinylester resins (bisphenol A or brominated) reinforced with fiberglass type E-CR, inner liner with fiberglass veils type C. Design pressure 16bar@85°C
3. Standard	ISO 14692	ISO 14692	ISO 14692
4. Pressure class or thickness	-	-	-
5. End connections	-	-	-
6. Size Range (NPS)	-	-	-
7. Additional requirement	-	-	-

B12.2.10 REDUCING COUPLING, B16.11

Commodity Code	C08-02	C08-04	C08-27
Specs	B4 B9 B10 C4 C8 C9 C10 E8 E9 E10 F10 G10P	B6 B19 C6 C19 E6 E19 F6	B16 C16 E16
1. Fitting type	Reducing Coupling, B16.11	Reducing Coupling, B16.11	Reducing Coupling, B16.11
2. Material	ASTM A105	ASTM A350 Gr LF2 Cl 1	ASTM A182 Gr F51 (UNS S31803)
3. Standard	ASME B16.11	ASME B16.11	ASME B16.11
4. Pressure class or thickness	3000, 6000, 9000	3000, 6000, 9000	3000
5. End connections	Socket Weld ¾" NPT Threaded End	Socket Weld ¾" NPT Threaded End	Socket Weld ¾" NPT Threaded End
6. Size Range (NPS)	¾" - 1 ½"	¾" - 1 ½"	¾" - 1 ½"
7. Additional requirement	-	-	-

Commodity Code	C08-30	C08-33	C08-35
Specs	B12 C12	B30 C30 E30 E32	B7R B7
1. Fitting type	Reducing Coupling, B16.11	Reducing Coupling, B16.11	Reducing Coupling, B16.11
2. Material	ASTM A182 Gr F55 (UNS S32760)	ASTM B366 (UNS N06625)	Cu-Ni 90/10 (UNS C70620)
3. Standard	ASME B16.11	ASME B16.11	EEMUA 234
4. Pressure class or thickness	3000	3000	20 bar
5. End connections	Socket Weld ¾" NPT Threaded End	Socket Weld ¾" NPT Threaded End	Female Capilar, Male x Female Capilar -
6. Size Range (NPS)	¾" - 1 ½"	¾" - 1 ½"	¾" - 2"
7. Additional requirement	-	-	-

Commodity Code	C08-43	C08-52	C08-53
Specs	B3 C3 E3 F3 G3		
1. Fitting type	Reducing Coupling, B16.11	Reducing Coupling, B16.11	Reducing Coupling, B16.11
2. Material	ASTM A182 Gr F316/316L	FRP - Bisphenol A Epoxy resins reinforced with fiberglass type E or E-CR. Design pressure 10bar@90°C	FRP - Bisphenol A Epoxy vinylester resins reinforced with fiberglass type E or E-CR. Design pressure 10bar@90°C.
3. Standard	ASME B16.11	ISO 14692	ISO 14692
4. Pressure class or thickness	3000	-	-
5. End connections	Socket Weld	-	-
6. Size Range (NPS)	¾" - 1 ½"	-	-
7. Additional requirement	-	-	-

Commodity Code	C08-54	C08-55	C08-56
Specs			
1. Fitting type	Reducing Coupling, B16.11	Reducing Coupling, B16.11	Reducing Coupling, B16.11
2. Material	FRP - Bisphenol A Epoxy resins reinforced with fiberglass type E or E-CR. Design pressure 16bar@90°C	FRP - Bisphenol A Epoxy vinylester resins reinforced with fiberglass type E or E-CR. Design pressure 16bar@90°C.	FRP - Bisphenol A Epoxy resins reinforced with fiberglass type E or E-CR. Design pressure 16bar@120°C
3. Standard	ISO 14692	ISO 14692	ISO 14692
4. Pressure class or thickness	-	-	-
5. End connections	-	-	-
6. Size Range (NPS)	-	-	-
7. Additional requirement	-	-	-

Commodity Code	C08-57	C08-62
Specs		B50
1. Fitting type	Reducing Coupling, B16.11	Reducing Coupling, B16.11
2. Material	FRP - Epoxy vinylester resins (bisphenol A or brominated) reinforced with fiberglass type E-CR, inner liner with fiberglass veils type C. Design pressure 16bar@85°C	ASTM A182 Gr F310H
3. Standard	ISO 14692	ASME B16.11
4. Pressure class or thickness	-	3000
5. End connections	-	Socket Weld
6. Size Range (NPS)	-	¾" - 1 ½"
7. Additional requirement	-	-

B12.2.11 HEX HEAD PLUG, B16.11

Commodity Code	C09-26	C09-35	C09-36
Specs		B7R B7	B22 B23 B26 C23
1. Fitting type	Hex Head Plug, B16.11	Hex Head Plug, B16.11	Hex Head Plug, B16.11
2. Material	ASTM A182 Gr F316	Cu-Ni 90/10 (UNS C70620)	ASTM B62 (UNS C83600)
3. Standard	ASME B16.11	EEMUA 234	ASME B16.15
4. Pressure class or thickness	-	20 bar	250
5. End connections	Beveled End	NPT Threaded End	NPT Threaded End
6. Size Range (NPS)	½" - 2"	½" - 1 ½"	1" - 1 ½"
7. Additional requirement	-	-	-

Commodity Code	C09-50	C09-51
Specs	B20	B21
1. Fitting type	Hex Head Plug, B16.11	Hex Head Plug, B16.11
2. Material	PVC - ASTM D1784 class 12454	CPVC - ASTM D1784 class 23447
3. Standard	ASTM D2464	ASTM F439
4. Pressure class or thickness	-	-
5. End connections	NPT Threaded End , Socket	NPT Threaded End , Socket
6. Size Range (NPS)	½" - 2"	½" - 2"
7. Additional requirement	-	-

B12.2.12 UNION

Commodity Code	C10-02	C10-35	C10-50
Specs	C8 E8	B7R B7	B20
1. Fitting type	Union	Union	Union
2. Material	ASTM A105	Cu-Ni 90/10 (UNS C70620)	PVC - ASTM D1784 class 12454
3. Standard	ASME B16.11	EEMUA 234	ASTM D2467
4. Pressure class or thickness	3000	20 bar	-
5. End connections	NPT Threaded End , Socket Weld	Female Capilar	Socket
6. Size Range (NPS)	½" - 1 ½"	½" - 1 ½"	½" - 4"
7. Additional requirement	-	-	-

Commodity Code	C10-51
Specs	B21
1. Fitting type	Union
2. Material	CPVC - ASTM D1784 class 23447
3. Standard	ASTM F439
4. Pressure class or thickness	-
5. End connections	Socket
6. Size Range (NPS)	½" - 4"
7. Additional requirement	-

B12.2.13 CAP, B16.11

Commodity Code	C11-02	C11-04	C11-27
Specs	B4 B9 B10 C4 C8 C9 C10 E8 E9 E10 F10 G10P	B6 B19 C6 C19 E6 E19 F6	B16 C16 E16
1. Fitting type	Cap, B16.11	Cap, B16.11	Cap, B16.11
2. Material	ASTM A105	ASTM A350 Gr LF2 Cl 1	ASTM A182 Gr F51 (UNS S31803)
3. Standard	ASME B16.11	ASME B16.11	ASME B16.11
4. Pressure class or thickness	3000, 6000, 9000	3000, 6000, 9000	3000
5. End connections	NPT Threaded End , Socket Weld 1" - 1 ½" Beveled End	NPT Threaded End , Socket Weld	NPT Threaded End , Socket Weld
6. Size Range (NPS)	½" - 1 ½"	½" - 1 ½"	½" - 1 ½"
7. Additional requirement	-	-	-

Commodity Code	C11-30	C11-33	C11-35
Specs	B12 C12	B30 C30 E30 E32	B7R B7
1. Fitting type	Cap, B16.11	Cap, B16.11	Cap, B16.11
2. Material	ASTM A182 Gr F55 (UNS S32760)	ASTM B366 (UNS N06625)	Cu-Ni 90/10 (UNS C70620)
3. Standard	ASME B16.11	ASME B16.11	EEMUA 234
4. Pressure class or thickness	3000	3000	20 bar
5. End connections	NPT Threaded End , Socket Weld	NPT Threaded End , Socket Weld	Female Capilar
6. Size Range (NPS)	½" - 1 ½"	½" - 1 ½"	½" - 1 ½"
7. Additional requirement	-	-	-

Commodity Code	C11-43	C11-50	C11-51
Specs	B3 C3 E3 F3 G3	B20	B21
1. Fitting type	Cap, B16.11	Cap, B16.11	Cap, B16.11
2. Material	ASTM A182 Gr F316/316L	PVC - ASTM D1784 class 12454	CPVC - ASTM D1784 class 23447
3. Standard	ASME B16.11	ASTM D2467	ASTM F439
4. Pressure class or thickness	3000	-	-
5. End connections	Socket Weld	Socket ½" - 2" NPT Threaded End	Socket ½" - 2" NPT Threaded End
6. Size Range (NPS)	½" - 1 ½"	½" - 8"	½" - 8"
7. Additional requirement	-	-	-

Commodity Code	C11-62
Specs	B50
1. Fitting type	Cap, B16.11
2. Material	ASTM A182 Gr F310H
3. Standard	ASME B16.11
4. Pressure class or thickness	3000
5. End connections	Socket Weld
6. Size Range (NPS)	½" - 1 ½"
7. Additional requirement	-

B12.2.14 WELDOLET

Commodity Code	C12-02	C12-04	C12-22
Specs	B4 B9 B10 B11 B14 B30 C4 C8 C9 C10 C11 C30 E8	B6 B19 C6 C19 E6 E19 F6 H6	E9 E10 E30 F10 G10P H10 H30P H30
1. Fitting type	Weldolet	Weldolet	Weldolet
2. Material	ASTM A105	ASTM A350 Gr LF2 Cl 1	ASTM A694 Gr F65
3. Standard	MSS SP-97	MSS SP-97	MSS SP-97
4. Pressure class or thickness	-	-	-
5. End connections	Beveled end	Beveled end	Beveled end
6. Size Range (NPS)	1" - 20"	1" - 50"	1" - 16"
7. Additional requirement	-	-	-

Commodity Code	C12-27	C12-30	C12-33
Specs	B16 C16 E16 H16	B12 C12 H12P H12 J12P J12	B30 C30 E30 E32 H30P H30 J40P J40
1. Fitting type	Weldolet	Weldolet	Weldolet
2. Material	ASTM A182 Gr F51 (UNS S31803)	ASTM A182 Gr F55 (UNS S32760)	ASTM B366 (UNS N06625)
3. Standard	MSS SP-97	MSS SP-97	MSS SP-97
4. Pressure class or thickness	-	-	-
5. End connections	Beveled end	Beveled end	Beveled end
6. Size Range (NPS)	1" - 16"	1" - 16"	1" - 6"
7. Additional requirement	-	-	-

Commodity Code	C12-35	C12-43	C12-62
Specs	B7R B7	B3 C3 E3 F3 G3 H3	B50
1. Fitting type	Weldolet	Weldolet	Weldolet
2. Material	Cu-Ni 90/10 (UNS C70620)	ASTM A182 Gr F316/316L	ASTM A182 Gr F310H
3. Standard	EEMUA 234	MSS SP-97	MSS SP-97
4. Pressure class or thickness	-	-	-
5. End connections	Beveled end	Beveled end	Beveled end
6. Size Range (NPS)	2" - 16"	1" - 18"	2" - 24"
7. Additional requirement	-	-	-

B12.2.15 LONG RADIUS 90 DEG ELBOW

Commodity Code	C15-03	C15-05	C15-11
Specs	B4 B9 B10 B11 B14 B30 C4 C8 C9 C10 C11 C30 E8 H10	B6 B19 C6 C19 E6 E19 F6 H6	E32
1. Fitting type	Long Radius 90 deg Elbow	Long Radius 90 deg Elbow	Long Radius 90 deg Elbow
2. Material	ASTM A234 Gr WPB	ASTM A420 Gr WPL6	ASTM A420 Gr WPL3
3. Standard	ASME B16.9	ASME B16.9	ASME B16.9
4. Pressure class or thickness	-	-	-
5. End connections	Beveled End	Beveled End	Beveled End
6. Size Range (NPS)	1" - 44"	1" - 36"	4" - 16"
7. Additional requirement	-	-	-

Commodity Code	C15-22	C15-29	C15-32
Specs	E9 E10 E30 F10 G10P H10 H30	B16 C16 E16 H16	B12 C12 H12P H12 J12P J12
1. Fitting type	Long Radius 90 deg Elbow	Long Radius 90 deg Elbow	Long Radius 90 deg Elbow
2. Material	ASTM A860 WPHY65	ASTM A815 (UNS S31803)	ASTM A815 (UNS S32760)
3. Standard	MSS SP-75	ASME B16.9	ASME B16.9
4. Pressure class or thickness	""	-	-
5. End connections	Beveled End	Beveled End	Beveled End
6. Size Range (NPS)	1" - 24"	1" - 34"	1" - 36"
7. Additional requirement	-	-	-

Commodity Code	C15-33	C15-35	C15-44
Specs	B30 C30 E30 E32 H30P H30 J40P J40	B7R B7	B3 C3 E3 F3 G3 H3
1. Fitting type	Long Radius 90 deg Elbow	Long Radius 90 deg Elbow	Long Radius 90 deg Elbow
2. Material	ASTM B366 (UNS N06625)	Cu-Ni 90/10 (UNS C70620)	ASTM A403 Gr WP316/316L
3. Standard	ASME B16.9	EEMUA 234	ASME B16.9
4. Pressure class or thickness	-	-	-
5. End connections	Beveled End	Beveled End	Beveled End
6. Size Range (NPS)	1" - 14"	2" - 36"	1" - 40"
7. Additional requirement	-	-	-

Commodity Code	C15-52	C15-53	C15-54
Specs	B22		B23
1. Fitting type	Long Radius 90 deg Elbow	Long Radius 90 deg Elbow	Long Radius 90 deg Elbow
2. Material	FRP - Bisphenol A Epoxy resins reinforced with fiberglass type E or E-CR. Design pressure 10bar@90°C	FRP - Bisphenol A Epoxy vinylester resins reinforced with fiberglass type E or E-CR. Design pressure 10bar@90°C.	FRP - Bisphenol A Epoxy resins reinforced with fiberglass type E or E-CR. Design pressure 16bar@90°C
3. Standard	ISO 14692	ISO 14692	ISO 14692
4. Pressure class or thickness	10 bar	-	16 bar
5. End connections	Bell-Spigot, Butt-Strap	-	Bell-Spigot, Butt-Strap
6. Size Range (NPS)	1" - 40"	-	1" - 46"
7. Additional requirement	-	-	-

Commodity Code	C15-55	C15-56	C15-57
Specs		B26	B27
1. Fitting type	Long Radius 90 deg Elbow	Long Radius 90 deg Elbow	Long Radius 90 deg Elbow
2. Material	FRP - Bisphenol A Epoxy vinylester resins reinforced with fiberglass type E or E-CR. Design pressure 16bar@90°C.	FRP - Bisphenol A Epoxy resins reinforced with fiberglass type E or E-CR. Design pressure 16bar@120°C	FRP - Epoxy vinylester resins (bisphenol A or brominated) reinforced with fiberglass type E-CR, inner liner with fiberglass veils type C. Design pressure 16bar@85°C
3. Standard	ISO 14692	ISO 14692	ISO 14692
4. Pressure class or thickness	-	16 bar	16 bar
5. End connections	-	Bell-Spigot, Butt-Strap	Bell-Spigot, Butt-Strap
6. Size Range (NPS)	-	1" - 36"	1" - 6"
7. Additional requirement	-	-	-

Commodity Code	C15-58	C15-59	C15-60
Specs			
1. Fitting type	Long Radius 90 deg Elbow	Long Radius 90 deg Elbow	Long Radius 90 deg Elbow
2. Material	RPVC - Glass fiber reinforced PVC	RPVC - Glass fiber reinforced PVC	RPVC - Glass fiber reinforced PVC
3. Standard	according to manufacturer	according to manufacturer	according to manufacturer
4. Pressure class or thickness	-	-	-
5. End connections	-	-	-
6. Size Range (NPS)	-	-	-
7. Additional requirement	-	-	-

Commodity Code	C15-63	C15-64
Specs	B50	C23
1. Fitting type	Long Radius 90 deg Elbow	Long Radius 90 deg Elbow
2. Material	ASTM A403 Gr WP310H	FRP - Bisphenol A Epoxy resins reinforced with fiberglass type E or E-CR. Design pressure 25bar@90°C
3. Standard	ASME B16.9	ISO 14692
4. Pressure class or thickness	-	25 bar
5. End connections	Beveled End	Bell-Spigot, Butt-Strap
6. Size Range (NPS)	2" - 48"	1" - 28"
7. Additional requirement	-	-

B12.2.16 LONG RADIUS 45 DEG ELBOW

Commodity Code	C16-03	C16-05	C16-11
Specs	B4 B9 B10 B11 B14 B30 C4 C8 C9 C10 C11 C30 E8 H10	B6 B19 C6 C19 E6 E19 F6 H6	E32
1. Fitting type	Long Radius 45 deg Elbow	Long Radius 45 deg Elbow	Long Radius 45 deg Elbow
2. Material	ASTM A234 Gr WPB	ASTM A420 Gr WPL6	ASTM A420 Gr WPL3
3. Standard	ASME B16.9	ASME B16.9	ASME B16.9
4. Pressure class or thickness	-	-	-
5. End connections	Beveled End	Beveled End	Beveled End
6. Size Range (NPS)	1" - 44"	1" - 36"	4" - 16"
7. Additional requirement	-	-	-

Commodity Code	C16-22	C16-29	C16-32
Specs	E9 E10 E30 F10 G10P H10 H30	B16 C16 E16 H16	B12 C12 H12P H12 J12P J12
1. Fitting type	Long Radius 45 deg Elbow	Long Radius 45 deg Elbow	Long Radius 45 deg Elbow
2. Material	ASTM A860 WPHY65	ASTM A815 (UNS S31803)	ASTM A815 (UNS S32760)
3. Standard	MSS SP-75	ASME B16.9	ASME B16.9
4. Pressure class or thickness	""	-	-
5. End connections	Beveled End	Beveled End	Beveled End
6. Size Range (NPS)	1" - 24"	1" - 34"	1" - 36"
7. Additional requirement	-	-	-

Commodity Code	C16-33	C16-35	C16-44
Specs	B30 C30 E30 E32 H30P H30 J40P J40	B7R B7	B3 C3 E3 F3 G3 H3
1. Fitting type	Long Radius 45 deg Elbow	Long Radius 45 deg Elbow	Long Radius 45 deg Elbow
2. Material	ASTM B366 (UNS N06625)	Cu-Ni 90/10 (UNS C70620)	ASTM A403 Gr WP316/316L
3. Standard	ASME B16.9	EEMUA 234	ASME B16.9
4. Pressure class or thickness	-	-	-
5. End connections	Beveled End	Beveled End	Beveled End
6. Size Range (NPS)	1" - 14"	2" - 36"	1" - 40"
7. Additional requirement	-	-	-

Commodity Code	C16-52	C16-53	C16-54
Specs	B22		B23
1. Fitting type	Long Radius 45 deg Elbow	Long Radius 45 deg Elbow	Long Radius 45 deg Elbow
2. Material	FRP - Bisphenol A Epoxy resins reinforced with fiberglass type E or E-CR. Design pressure 10bar@90°C	FRP - Bisphenol A Epoxy vinyl ester resins reinforced with fiberglass type E or E-CR. Design pressure 10bar@90°C.	FRP - Bisphenol A Epoxy resins reinforced with fiberglass type E or E-CR. Design pressure 16bar@90°C
3. Standard	ISO 14692	ISO 14692	ISO 14692
4. Pressure class or thickness	10 bar	-	16 bar
5. End connections	Bell-Spigot, Butt-Strap	-	Bell-Spigot, Butt-Strap
6. Size Range (NPS)	1" - 40"	-	1" - 46"
7. Additional requirement	-	-	-

Commodity Code	C16-55	C16-56	C16-57
Specs		B26	B27
1. Fitting type	Long Radius 45 deg Elbow	Long Radius 45 deg Elbow	Long Radius 45 deg Elbow
2. Material	FRP - Bisphenol A Epoxy vinyl ester resins reinforced with fiberglass type E or E-CR. Design pressure 16bar@90°C.	FRP - Bisphenol A Epoxy resins reinforced with fiberglass type E or E-CR. Design pressure 16bar@120°C	FRP - Epoxy vinyl ester resins (bisphenol A or brominated) reinforced with fiberglass type E-CR, inner liner with fiberglass veils type C. Design pressure 16bar@85°C
3. Standard	ISO 14692	ISO 14692	ISO 14692
4. Pressure class or thickness	-	16 bar	16 bar
5. End connections	-	Bell-Spigot, Butt-Strap	Bell-Spigot, Butt-Strap
6. Size Range (NPS)	-	1" - 36"	1" - 6"
7. Additional requirement	-	-	-

Commodity Code	C16-58	C16-59	C16-60
Specs			
1. Fitting type	Long Radius 45 deg Elbow	Long Radius 45 deg Elbow	Long Radius 45 deg Elbow
2. Material	RPVC - Glass fiber reinforced PVC	RPVC - Glass fiber reinforced PVC	RPVC - Glass fiber reinforced PVC
3. Standard	according to manufacturer	according to manufacturer	according to manufacturer
4. Pressure class or thickness	-	-	-
5. End connections	-	-	-
6. Size Range (NPS)	-	-	-
7. Additional requirement	-	-	-

Commodity Code	C16-63	C16-64
Specs	B50	C23
1. Fitting type	Long Radius 45 deg Elbow	Long Radius 45 deg Elbow
2. Material	ASTM A403 Gr WP310H	FRP - Bisphenol A Epoxy resins reinforced with fiberglass type E or E-CR. Design pressure 25bar@90°C
3. Standard	ASME B16.9	ISO 14692
4. Pressure class or thickness	-	25 bar
5. End connections	Beveled End	Bell-Spigot, Butt-Strap
6. Size Range (NPS)	2" - 48"	1" - 28"
7. Additional requirement	-	-

B12.2.17 SHORT RADIUS 90 DEG ELBOW

Commodity Code	C17-03	C17-05	C17-11
Specs	B4 B9 B10 B11 B14 B30 C4 C8 C9 C10 C11 C30 E8 H10	B6 B19 C6 C19 E6 E19 F6 H6	E32
1. Fitting type	Short radius 90 deg Elbow	Short radius 90 deg Elbow	Short radius 90 deg Elbow
2. Material	ASTM A234 Gr WPB	ASTM A420 Gr WPL6	ASTM A420 Gr WPL3
3. Standard	ASME B16.9	ASME B16.9	ASME B16.9
4. Pressure class or thickness	-	-	-
5. End connections	Beveled End	Beveled End	Beveled End
6. Size Range (NPS)	1" - 44"	1" - 36"	4" - 16"
7. Additional requirement	-	-	-

Commodity Code	C17-22	C17-29	C17-32
Specs	E9 E10 E30 F10 G10P H10 H30	B16 C16 E16 H16	B12 C12 H12P H12 J12P J12
1. Fitting type	Short radius 90 deg Elbow	Short radius 90 deg Elbow	Short radius 90 deg Elbow
2. Material	ASTM A860 WPHY65	ASTM A815 (UNS S31803)	ASTM A815 (UNS S32760)
3. Standard	MSS SP-75	ASME B16.9	ASME B16.9
4. Pressure class or thickness	""	-	-
5. End connections	Beveled End	Beveled End	Beveled End
6. Size Range (NPS)	1" - 24"	1" - 34"	1" - 36"
7. Additional requirement	-	-	-

Commodity Code	C17-33	C17-44	C17-63
Specs	B30 C30 E30 E32 H30P H30 J40P J40	B3 C3 E3 F3 G3 H3	B50
1. Fitting type	Short radius 90 deg Elbow	Short radius 90 deg Elbow	Short radius 90 deg Elbow
2. Material	ASTM B366 (UNS N06625)	ASTM A403 Gr WP316/316L	ASTM A403 Gr WP310H
3. Standard	ASME B16.9	ASME B16.9	ASME B16.9
4. Pressure class or thickness	-	-	-
5. End connections	Beveled End	Beveled End	Beveled End
6. Size Range (NPS)	1" - 14"	1" - 40"	2" - 24"
7. Additional requirement	-	-	-

B12.2.18 CONCENTRIC REDUCING

Commodity Code	C18-03	C18-05	C18-11
Specs	B4 B9 B10 B11 B14 B30 C4 C8 C9 C10 C11 C30 E8 H10	B6 B19 C6 C19 E6 E19 F6 H6	E32
1. Fitting type	Concentric Reducing	Concentric Reducing	Concentric Reducing
2. Material	ASTM A234 Gr WPB	ASTM A420 Gr WPL6	ASTM A420 Gr WPL3
3. Standard	ASME B16.9	ASME B16.9	ASME B16.9
4. Pressure class or thickness	-	-	-
5. End connections	Beveled end	Beveled end	Beveled end
6. Size Range (NPS)	1 ½" - 44"	1 ½" - 36"	6" - 16"
7. Additional requirement	-	-	-

Commodity Code	C18-22	C18-29	C18-32
Specs	E9 E10 E30 F10 G10P H10 H30	B16 C16 E16 H16	B12 C12 H12P H12 J12P J12
1. Fitting type	Concentric Reducing	Concentric Reducing	Concentric Reducing
2. Material	ASTM A860 WPHY65	ASTM A815 (UNS S31803)	ASTM A815 (UNS S32760)
3. Standard	MSS SP-75	ASME B16.9	ASME B16.9
4. Pressure class or thickness	-	-	-
5. End connections	Beveled end	Beveled end	Beveled end
6. Size Range (NPS)	1 ½" - 24"	1 ½" - 34"	1 ½" - 44"
7. Additional requirement	-	-	-

Commodity Code	C18-33	C18-35	C18-44
Specs	B30 C30 E30 E32 H30P H30 J40P J40	B7R B7	B3 C3 E3 F3 G3 H3
1. Fitting type	Concentric Reducing	Concentric Reducing	Concentric Reducing
2. Material	ASTM B366 (UNS N06625)	Cu-Ni 90/10 (UNS C70620)	ASTM A403 Gr WP316/316L
3. Standard	ASME B16.9	EEMUA 234	ASME B16.9
4. Pressure class or thickness	-	-	-
5. End connections	Beveled end	Beveled end	Beveled end
6. Size Range (NPS)	1 ½" - 14"	3" - 36"	2" - 40"
7. Additional requirement	-	-	-

Commodity Code	C18-63
Specs	B50
1. Fitting type	Concentric Reducing
2. Material	ASTM A403 Gr WP310H
3. Standard	ASME B16.9
4. Pressure class or thickness	-
5. End connections	Beveled end
6. Size Range (NPS)	3" - 48"
7. Additional requirement	-

B12.2.19 ECCENTRIC REDUCING

Commodity Code	C19-03	C19-05	C19-11
Specs	B4 B9 B10 B11 B14 B30 C4 C8 C9 C10 C11 C30 E8 H10	B6 B19 C6 C19 E6 E19 F6 H6	E32
1. Fitting type	Eccentric Reducing	Eccentric Reducing	Eccentric Reducing
2. Material	ASTM A234 Gr WPB	ASTM A420 Gr WPL6	ASTM A420 Gr WPL3
3. Standard	ASME B16.9	ASME B16.9	ASME B16.9
4. Pressure class or thickness	-	-	-
5. End connections	Beveled end	Beveled end	Beveled end
6. Size Range (NPS)	1 ½" - 44"	1 ½" - 36"	6" - 16"
7. Additional requirement	-	-	-

Commodity Code	C19-22	C19-29	C19-32
Specs	E9 E10 E30 F10 G10P H10 H30	B16 C16 E16 H16	B12 C12 H12P H12 J12P J12
1. Fitting type	Eccentric Reducing	Eccentric Reducing	Eccentric Reducing
2. Material	ASTM A860 WPHY65	ASTM A815 (UNS S31803)	ASTM A815 (UNS S32760)
3. Standard	MSS SP-75	ASME B16.9	ASME B16.9
4. Pressure class or thickness	-	-	-
5. End connections	Beveled end	Beveled end	Beveled end
6. Size Range (NPS)	1 ½" - 24"	1 ½" - 34"	1 ½" - 36"
7. Additional requirement	-	-	-

Commodity Code	C19-33	C19-35	C19-44
Specs	B30 C30 E30 E32 H30P H30 J40P J40	B7R B7	B3 C3 E3 F3 G3 H3
1. Fitting type	Eccentric Reducing	Eccentric Reducing	Eccentric Reducing
2. Material	ASTM B366 (UNS N06625)	Cu-Ni 90/10 (UNS C70620)	ASTM A403 Gr WP316/316L
3. Standard	ASME B16.9	EEMUA 234	ASME B16.9
4. Pressure class or thickness	-	-	-
5. End connections	Beveled end	Beveled end	Beveled end
6. Size Range (NPS)	1 ½" - 14"	3" - 36"	2" - 40"
7. Additional requirement	-	-	-

Commodity Code	C19-63
Specs	B50
1. Fitting type	Eccentric Reducing
2. Material	ASTM A403 Gr WP310H
3. Standard	ASME B16.9
4. Pressure class or thickness	-
5. End connections	Beveled end
6. Size Range (NPS)	3" - 48"
7. Additional requirement	-

B12.2.20 TEE

Commodity Code	C20-03	C20-05	C20-11
Specs	B4 B9 B10 B11 B14 B30 C4 C8 C9 C10 C11 C30 E8 H10	B6 B19 C6 C19 E6 E19 F6 H6	E32
1. Fitting type	Tee	Tee	Tee
2. Material	ASTM A234 Gr WPB	ASTM A420 Gr WPL6	ASTM A420 Gr WPL3
3. Standard	ASME B16.9	ASME B16.9	ASME B16.9
4. Pressure class or thickness	-	-	-
5. End connections	Beveled End	Beveled End	Beveled End
6. Size Range (NPS)	1" - 44"	1" - 36"	4" - 16"
7. Additional requirement	-	-	-

Commodity Code	C20-22	C20-29	C20-32
Specs	E9 E10 E30 F10 G10P H10 H30P H30	B16 C16 E16 H16	B12 C12 H12P H12 J12P J12
1. Fitting type	Tee	Tee	Tee
2. Material	ASTM A860 WPHY65	ASTM A815 (UNS S31803)	ASTM A815 (UNS S32760)
3. Standard	MSS SP-75	ASME B16.9	ASME B16.9
4. Pressure class or thickness	""	-	-
5. End connections	Beveled End	Beveled End	Beveled End
6. Size Range (NPS)	1" - 34"	1" - 34"	1" - 36"
7. Additional requirement	-	-	-

Commodity Code	C20-33	C20-35	C20-44
Specs	B30 C30 E30 E32 H30P H30 J40P J40	B7R B7	B3 C3 E3 F3 G3 H3
1. Fitting type	Tee	Tee	Tee
2. Material	ASTM B366 (UNS N06625)	Cu-Ni 90/10 (UNS C70620)	ASTM A403 Gr WP316/316L
3. Standard	ASME B16.9	EEMUA 234	ASME B16.9
4. Pressure class or thickness	-	-	-
5. End connections	Beveled End	Beveled End	Beveled End
6. Size Range (NPS)	1" - 14"	2" - 36"	2" - 40"
7. Additional requirement	-	-	-

Commodity Code	C20-50	C20-51	C20-52
Specs			B22
1. Fitting type	Tee	Tee	Tee
2. Material	PVC - ASTM D1784 class 12454	CPVC - ASTM D1784 class 23447	FRP - Bisphenol A Epoxy resins reinforced with fiberglass type E or E-CR. Design pressure 10bar@90°C
3. Standard	ASTM D2464	ASTM F439	ISO 14692
4. Pressure class or thickness	-	-	10 bar
5. End connections	-	-	Bell-Spigot, Butt-Strap
6. Size Range (NPS)	-	-	1" - 40"
7. Additional requirement	-	-	-

Commodity Code	C20-53	C20-54	C20-55
Specs		B23	
1. Fitting type	Tee	Tee	Tee
2. Material	FRP - Bisphenol A Epoxy vinylester resins reinforced with fiberglass type E or E-CR. Design pressure 10bar@90°C.	FRP - Bisphenol A Epoxy resins reinforced with fiberglass type E or E-CR. Design pressure 16bar@90°C	FRP - Bisphenol A Epoxy vinylester resins reinforced with fiberglass type E or E-CR. Design pressure 16bar@90°C.
3. Standard	ISO 14692	ISO 14692	ISO 14692
4. Pressure class or thickness	-	16 bar	-
5. End connections	-	Bell-Spigot, Butt-Strap	-
6. Size Range (NPS)	-	1" - 46"	-
7. Additional requirement	-	-	-

Commodity Code	C20-56	C20-57	C20-63
Specs	B26	B27	B50
1. Fitting type	Tee	Tee	Tee
2. Material	FRP - Bisphenol A Epoxy resins reinforced with fiberglass type E or E-CR. Design pressure 16bar@120°C	FRP - Epoxy vinylester resins (bisphenol A or brominated) reinforced with fiberglass type E-CR, inner liner with fiberglass veils type C. Design pressure 16bar@85°C	ASTM A403 Gr WP310H
3. Standard	ISO 14692	ISO 14692	ASME B16.9
4. Pressure class or thickness	16 bar	16 bar	-
5. End connections	Bell-Spigot, Butt-Strap	Bell-Spigot, Butt-Strap	Beveled End
6. Size Range (NPS)	1" - 36"	1" - 6"	2" - 48"
7. Additional requirement	-	-	-

Commodity Code	C20-64
Specs	C23
1. Fitting type	Tee
2. Material	FRP - Bisphenol A Epoxy resins reinforced with fiberglass type E or E-CR. Design pressure 25bar@90°C
3. Standard	ISO 14692
4. Pressure class or thickness	25 bar
5. End connections	Bell-Spigot, Butt-Strap
6. Size Range (NPS)	1" - 28"
7. Additional requirement	-

B12.2.21 REDUCING TEE

Commodity Code	C21-03	C21-05	C21-11
Specs	B4 B9 B10 B11 B14 B30 C4 C8 C9 C10 C11 C30 E8 H10	B6 B19 C6 C19 E6 E19 F6 H6	E32
1. Fitting type	Reducing Tee	Reducing Tee	Reducing Tee
2. Material	ASTM A234 Gr WPB	ASTM A420 Gr WPL6	ASTM A420 Gr WPL3
3. Standard	ASME B16.9	ASME B16.9	ASME B16.9
4. Pressure class or thickness	-	-	-
5. End connections	Beveled end	Beveled end	Beveled end
6. Size Range (NPS)	1 ½" - 44"	1 ½" - 36"	6" - 16"
7. Additional requirement	-	-	-

Commodity Code	C21-22	C21-29	C21-32
Specs	E9 E10 E30 F10 G10P H10 H30P H30	B16 C16 E16 H16	B12 C12 H12P H12 J12P J12
1. Fitting type	Reducing Tee	Reducing Tee	Reducing Tee
2. Material	ASTM A860 WPHY65	ASTM A815 (UNS S31803)	ASTM A815 (UNS S32760)
3. Standard	MSS SP-75	ASME B16.9	ASME B16.9
4. Pressure class or thickness	-	-	-
5. End connections	Beveled end	Beveled end	Beveled end
6. Size Range (NPS)	1 ½" - 34"	2" - 34"	1 ½" - 36"
7. Additional requirement	-	-	-

Commodity Code	C21-33	C21-35	C21-44
Specs	B30 C30 E30 E32 H30P H30 J40P J40	B7R B7	B3 C3 E3 F3 G3 H3
1. Fitting type	Reducing Tee	Reducing Tee	Reducing Tee
2. Material	ASTM B366 (UNS N06625)	Cu-Ni 90/10 (UNS C70620)	ASTM A403 Gr WP316/316L
3. Standard	ASME B16.9	EEMUA 234	ASME B16.9
4. Pressure class or thickness	-	-	-
5. End connections	Beveled end	Beveled end	Beveled end
6. Size Range (NPS)	1 ½" - 14"	3" - 36"	1 ½" - 40"
7. Additional requirement	-	-	-

Commodity Code	C21-50	C21-51	C21-63
Specs	B20	B21	B50
1. Fitting type	Reducing Tee	Reducing Tee	Reducing Tee
2. Material	PVC - ASTM D1784 class 12454	CPVC - ASTM D1784 class 23447	ASTM A403 Gr WP310H
3. Standard	ASTM D2467	ASTM F439	ASME B16.9
4. Pressure class or thickness	-	-	-
5. End connections	Socket	Socket	Beveled end
6. Size Range (NPS)	¾" - 8"	¾" - 8"	3" - 48"
7. Additional requirement	-	-	-

B12.2.22 CAP

Commodity Code	C22-03	C22-05	C22-11
Specs	B4 B9 B10 B11 B14 B30 C4 C8 C9 C10 C11 C30 E8 H10	B6 B19 C6 C19 E6 E19 F6 H6	E32
1. Fitting type	Cap	Cap	Cap
2. Material	ASTM A234 Gr WPB	ASTM A420 Gr WPL6	ASTM A420 Gr WPL3
3. Standard	ASME B16.9	ASME B16.9	ASME B16.9
4. Pressure class or thickness	-	-	-
5. End connections	Beveled End	Beveled End	Beveled End
6. Size Range (NPS)	1" - 44"	1" - 36"	4" - 16"
7. Additional requirement	-	-	-

Commodity Code	C22-22	C22-29	C22-32
Specs	E9 E10 E30 F10 G10P H10 H30P H30	B16 C16 E16 H16	B12 C12 H12P H12 J12P J12
1. Fitting type	Cap	Cap	Cap
2. Material	ASTM A860 WPHY65	ASTM A815 (UNS S31803)	ASTM A815 (UNS S32760)
3. Standard	MSS SP-75	ASME B16.9	ASME B16.9
4. Pressure class or thickness	""	-	-
5. End connections	Beveled End	Beveled End	Beveled End
6. Size Range (NPS)	1" - 34"	1" - 34"	1" - 36"
7. Additional requirement	-	-	-

Commodity Code	C22-33	C22-35	C22-44
Specs	B30 C30 E30 E32 H30P H30 J40P J40	B7R B7	B3 C3 E3 F3 G3 H3
1. Fitting type	Cap	Cap	Cap
2. Material	ASTM B366 (UNS N06625)	Cu-Ni 90/10 (UNS C70620)	ASTM A403 Gr WP316/316L
3. Standard	ASME B16.9	EEMUA 234	ASME B16.9
4. Pressure class or thickness	-	-	-
5. End connections	Beveled End	Beveled End	Beveled End
6. Size Range (NPS)	1" - 14"	2" - 36"	1" - 40"
7. Additional requirement	-	-	-

Commodity Code	C22-50	C22-51	C22-63
Specs			B50
1. Fitting type	Cap	Cap	Cap
2. Material	PVC - ASTM D1784 class 12454	CPVC - ASTM D1784 class 23447	ASTM A403 Gr WP310H
3. Standard	ASTM D2464	ASTM F439	ASME B16.9
4. Pressure class or thickness	-	-	-
5. End connections	-	-	Beveled End
6. Size Range (NPS)	-	-	2" - 48"
7. Additional requirement	-	-	-

B12.2.23 HEX HEAD BUSHING, B16.11

Commodity Code	C23-35
Specs	B7R B7
1. Fitting type	Hex Head Bushing, B16.11
2. Material	Cu-Ni 90/10 (UNS C70620)
3. Standard	EEMUA 234
4. Pressure class or thickness	20 bar, 3000, 6000, 9000 1 ½" 10 bar, 16 bar, 25 bar
5. End connections	Female Capilar, Female NPT Thread x Male Capilar, Male x Female Capilar, NPT Threaded End, Socket Weld 1 ½" Bell-Spigot, Butt-Strap, Elastic Joint / Bell x Spigot Ends, Rigid Joint / Bell x Spigot Ends, Rigid Joint / Spigot Ends
6. Size Range (NPS)	¾" - 1 ½"
7. Additional requirement	-

B12.2.24 CROSS

Commodity Code	C24-03	C24-05	C24-11
Specs	B4 B9 B10 B11 B14 B30 C4 C8 C9 C10 C11 C30 E8 H10	B6 B19 C6 C19 E6 E19 F6 H6	E32
1. Fitting type	Cross	Cross	Cross
2. Material	ASTM A234 Gr WPB	ASTM A420 Gr WPL6	ASTM A420 Gr WPL3
3. Standard	ASME B16.9	ASME B16.9	ASME B16.9
4. Pressure class or thickness	-	-	-
5. End connections	Beveled End	Beveled End	Beveled End
6. Size Range (NPS)	1" - 44"	1" - 36"	4" - 16"
7. Additional requirement	-	-	-

Commodity Code	C24-22	C24-29	C24-32
Specs	E9 E10 E30 F10 G10P H10 H30	B16 C16 E16 H16	B12 C12 H12P H12 J12P J12
1. Fitting type	Cross	Cross	Cross
2. Material	ASTM A860 WPHY65	ASTM A815 (UNS S31803)	ASTM A815 (UNS S32760)
3. Standard	MSS SP-75	ASME B16.9	ASME B16.9
4. Pressure class or thickness	""	-	-
5. End connections	Beveled End	Beveled End	Beveled End
6. Size Range (NPS)	1" - 24"	1" - 34"	1" - 36"
7. Additional requirement	-	-	-

Commodity Code	C24-33	C24-44	C24-50
Specs	B30 C30 E30 E32 H30P H30 J40P J40	B3 C3 E3 F3 G3 H3	
1. Fitting type	Cross	Cross	Cross
2. Material	ASTM B366 (UNS N06625)	ASTM A403 Gr WP316/316L	PVC - ASTM D1784 class 12454
3. Standard	ASME B16.9	ASME B16.9	ASTM D2464
4. Pressure class or thickness	-	-	-
5. End connections	Beveled End	Beveled End	-
6. Size Range (NPS)	1" - 16"	1" - 40"	-
7. Additional requirement	-	-	-

Commodity Code	C24-51	C24-63
Specs		B50
1. Fitting type	Cross	Cross
2. Material	CPVC - ASTM D1784 class 23447	ASTM A403 Gr WP310H
3. Standard	ASTM F439	ASME B16.9
4. Pressure class or thickness	-	-
5. End connections	-	Beveled End
6. Size Range (NPS)	-	2" - 48"
7. Additional requirement	-	-

B12.2.25 3D 45 DEG PIPE BEND

Commodity Code	C33-21	C33-31	C33-39
Specs	G10P H30P	H12P J12P	J40P
1. Fitting type	3D 45 deg Pipe Bend	3D 45 deg Pipe Bend	3D 45 deg Pipe Bend
2. Material	API 5L Gr X65 PSL 2	ASTM A790 (UNS S32760)	ASTM B444 Gr 1 (UNS N06625)
3. Standard	according to manufacturer	according to manufacturer	according to manufacturer
4. Pressure class or thickness	-	-	-
5. End connections	Beveled end	Beveled end	Beveled end
6. Size Range (NPS)	4" - 34"	2" - 18"	4" - 14"
7. Additional requirement	-	-	-

Commodity Code	C33-41	C33-46
Specs	H12P J12P	
1. Fitting type	3D 45 deg Pipe Bend	3D 45 deg Pipe Bend
2. Material	ASTM A928 (UNS S32760 Cl 1 or 3)	ASTM A358 TP316/316L
3. Standard	according to manufacturer	according to manufacturer
4. Pressure class or thickness	-	-
5. End connections	Beveled end	Beveled end
6. Size Range (NPS)	10" - 18"	-
7. Additional requirement	-	-

B12.2.26 3D 90 DEG PIPE BEND

Commodity Code	C35-21	C35-31	C35-39
Specs	G10P H30P	H12P J12P	J40P
1. Fitting type	3D 90 deg Pipe Bend	3D 90 deg Pipe Bend	3D 90 deg Pipe Bend
2. Material	API 5L Gr X65 PSL 2	ASTM A790 (UNS S32760)	ASTM B444 Gr 1 (UNS N06625)
3. Standard	according to manufacturer	according to manufacturer	according to manufacturer
4. Pressure class or thickness	-	-	-
5. End connections	Beveled end	Beveled end	Beveled end
6. Size Range (NPS)	4" - 34"	2" - 18"	4" - 14"
7. Additional requirement	-	-	-

Commodity Code	C35-41	C35-46
Specs	H12P J12P	
1. Fitting type	3D 90 deg Pipe Bend	3D 90 deg Pipe Bend
2. Material	ASTM A928 (UNS S32760 Cl 1 or 3)	ASTM A358 TP316/316L
3. Standard	according to manufacturer	according to manufacturer
4. Pressure class or thickness	-	-
5. End connections	Beveled end	Beveled end
6. Size Range (NPS)	10" - 18"	-
7. Additional requirement	-	-

B12.2.27 CONNECTOR

Commodity Code	C37-35	C37-50	C37-51
Specs	B7R B7	B20	B21
1. Fitting type	Connector	Connector	Connector
2. Material	Cu-Ni 90/10 (UNS C70620)	PVC - ASTM D1784 class 12454	CPVC - ASTM D1784 class 23447
3. Standard	EEMUA 234	ASTM D2464	ASTM F439
4. Pressure class or thickness	20 bar	-	-
5. End connections	-	-	-
6. Size Range (NPS)	½" - 1 ½"	½" - 2"	½" - 2"
7. Additional requirement	-	-	-

B12.2.28 CONNECTOR UNION

Commodity Code	C38-35
Specs	B7R B7
1. Fitting type	Connector Union
2. Material	Cu-Ni 90/10 (UNS C70620)
3. Standard	EEMUA 234
4. Pressure class or thickness	20 bar
5. End connections	-
6. Size Range (NPS)	½" - 1 ½"
7. Additional requirement	-

B12.2.29 STUB END WELDING NECK L TYPE

Commodity Code	C39-35
Specs	B7R B7
1. Fitting type	Stub End Welding Neck L type
2. Material	Cu-Ni 90/10 (UNS C70620)
3. Standard	EEMUA 234
4. Pressure class or thickness	20 bar 6" - 36" 16 bar
5. End connections	Beveled end
6. Size Range (NPS)	4" - 36"
7. Additional requirement	-

B12.2.30 45 DEG ELBOW MAF TYPE I - PRESS TYPE

Commodity Code	C40-02	C40-26	C40-34
Specs	S9B S9C	S3B S3C	S7
1. Fitting type	45 deg Elbow MAF Type I - Press Type	45 deg Elbow MAF Type I - Press Type	45 deg Elbow MAF Type I - Press Type
2. Material	ASTM A105	ASTM A182 Gr F316	Cu-Ni 70/30
3. Standard	ASTM F1387	ASTM F1387	ASTM F1387
4. Pressure class or thickness	-	-	-
5. End connections	MAF - Mechanically Attached Fitting	MAF - Mechanically Attached Fitting	MAF - Mechanically Attached Fitting
6. Size Range (NPS)	½" - 2"	½" - 2"	½" - 2"
7. Additional requirement	-	-	-

B12.2.31 90 DEG ELBOW MAF TYPE I - PRESS TYPE

Commodity Code	C41-02	C41-26	C41-34
Specs	S9B S9C	S3B S3C	S7
1. Fitting type	90 deg Elbow MAF Type I - Press Type	90 deg Elbow MAF Type I - Press Type	90 deg Elbow MAF Type I - Press Type
2. Material	ASTM A105	ASTM A182 Gr F316	Cu-Ni 70/30
3. Standard	ASTM F1387	ASTM F1387	ASTM F1387
4. Pressure class or thickness	-	-	-
5. End connections	MAF - Mechanically Attached Fitting	MAF - Mechanically Attached Fitting	MAF - Mechanically Attached Fitting
6. Size Range (NPS)	½" - 2"	½" - 2"	½" - 2"
7. Additional requirement	-	-	-

B12.2.32 COUPLING MAF TYPE I - PRESS TYPE

Commodity Code	C42-02	C42-26	C42-34
Specs	S9B S9C	S3B S3C	S7
1. Fitting type	Coupling MAF Type I - Press Type	Coupling MAF Type I - Press Type	Coupling MAF Type I - Press Type
2. Material	ASTM A105	ASTM A182 Gr F316	Cu-Ni 70/30
3. Standard	ASTM F1387	ASTM F1387	ASTM F1387
4. Pressure class or thickness	-	-	-
5. End connections	MAF - Mechanically Attached Fitting	MAF - Mechanically Attached Fitting	MAF - Mechanically Attached Fitting
6. Size Range (NPS)	½" - 2"	½" - 2"	½" - 2"
7. Additional requirement	-	-	-

B12.2.33 TEE MAF TYPE I - PRESS TYPE

Commodity Code	C43-02	C43-26	C43-34
Specs	S9B S9C	S3B S3C	S7
1. Fitting type	Tee MAF Type I - Press Type	Tee MAF Type I - Press Type	Tee MAF Type I - Press Type
2. Material	ASTM A105	ASTM A182 Gr F316	Cu-Ni 70/30
3. Standard	ASTM F1387	ASTM F1387	ASTM F1387
4. Pressure class or thickness	-	-	-
5. End connections	MAF - Mechanically Attached Fitting	MAF - Mechanically Attached Fitting	MAF - Mechanically Attached Fitting
6. Size Range (NPS)	½" - 2"	½" - 2"	½" - 2"
7. Additional requirement	-	-	-

B12.2.34 UNION MAF TYPE I - PRESS TYPE

Commodity Code	C44-02	C44-26	C44-34
Specs	S9B S9C	S3B S3C	S7
1. Fitting type	Union MAF Type I - Press Type	Union MAF Type I - Press Type	Union MAF Type I - Press Type
2. Material	ASTM A105	ASTM A182 Gr F316	Cu-Ni 70/30
3. Standard	ASTM F1387	ASTM F1387	ASTM F1387
4. Pressure class or thickness	-	-	-
5. End connections	MAF - Mechanically Attached Fitting	MAF - Mechanically Attached Fitting	MAF - Mechanically Attached Fitting
6. Size Range (NPS)	½" - 2"	½" - 2"	½" - 2"
7. Additional requirement	-	-	-

B12.2.35 CAP MAF TYPE I - PRESS TYPE

Commodity Code	C45-02	C45-26	C45-34
Specs	S9B S9C	S3B S3C	S7
1. Fitting type	Cap MAF Type I - Press Type	Cap MAF Type I - Press Type	Cap MAF Type I - Press Type
2. Material	ASTM A105	ASTM A182 Gr F316	Cu-Ni 70/30
3. Standard	ASTM F1387	ASTM F1387	ASTM F1387
4. Pressure class or thickness	-	-	-
5. End connections	MAF - Mechanically Attached Fitting	MAF - Mechanically Attached Fitting	MAF - Mechanically Attached Fitting
6. Size Range (NPS)	½" - 2"	½" - 2"	½" - 2"
7. Additional requirement	-	-	-

B12.2.36 45 DEG TEE

Commodity Code	C48-50	C48-51
Specs	B20	B21
1. Fitting type	45 deg Tee	45 deg Tee
2. Material	PVC - ASTM D1784 class 12454	CPVC - ASTM D1784 class 23447
3. Standard	ASTM D2467	ASTM F439
4. Pressure class or thickness	-	-
5. End connections	Socket	Socket
6. Size Range (NPS)	½" - 6"	½" - 6"
7. Additional requirement	-	-

B12.2.37 FLANGED SADDLE

Commodity Code	C51-52	C51-53	C51-54
Specs	B22		B23
1. Fitting type	Flanged Saddle	Flanged Saddle	Flanged Saddle
2. Material	FRP - Bisphenol A Epoxy resins reinforced with fiberglass type E or E-CR. Design pressure 10bar@90°C	FRP - Bisphenol A Epoxy vinylester resins reinforced with fiberglass type E or E-CR. Design pressure 10bar@90°C.	FRP - Bisphenol A Epoxy resins reinforced with fiberglass type E or E-CR. Design pressure 16bar@90°C
3. Standard	ISO 14692	ISO 14692	ISO 14692
4. Pressure class or thickness	-	-	-
5. End connections	-	-	-
6. Size Range (NPS)	1" - 6"	-	1" - 6"
7. Additional requirement	-	-	-

Commodity Code	C51-55	C51-56	C51-57
Specs		B26	B27
1. Fitting type	Flanged Saddle	Flanged Saddle	Flanged Saddle
2. Material	FRP - Bisphenol A Epoxy vinylester resins reinforced with fiberglass type E or E-CR. Design pressure 16bar@90°C.	FRP - Bisphenol A Epoxy resins reinforced with fiberglass type E or E-CR. Design pressure 16bar@120°C	FRP - Epoxy vinylester resins (bisphenol A or brominated) reinforced with fiberglass type E-CR, inner liner with fiberglass veils type C. Design pressure 16bar@85°C
3. Standard	ISO 14692	ISO 14692	ISO 14692
4. Pressure class or thickness	-	-	-
5. End connections	-	-	-
6. Size Range (NPS)	-	1" - 6"	1" - 4"
7. Additional requirement	-	-	-

Commodity Code	C51-64
Specs	C23
1. Fitting type	Flanged Saddle
2. Material	FRP - Bisphenol A Epoxy resins reinforced with fiberglass type E or E-CR. Design pressure 25bar@90°C
3. Standard	ISO 14692
4. Pressure class or thickness	-
5. End connections	-
6. Size Range (NPS)	1" - 6"
7. Additional requirement	-

B12.2.38 THREADED SADDLE FLG

Commodity Code	C52-52	C52-53	C52-54
Specs	B22		B23
1. Fitting type	Threaded Saddle Flg	Threaded Saddle Flg	Threaded Saddle Flg
2. Material	FRP - Bisphenol A Epoxy resins reinforced with fiberglass type E or E-CR. Design pressure 10bar@90°C	FRP - Bisphenol A Epoxy vinylester resins reinforced with fiberglass type E or E-CR. Design pressure 10bar@90°C.	FRP - Bisphenol A Epoxy resins reinforced with fiberglass type E or E-CR. Design pressure 16bar@90°C
3. Standard	ISO 14692	ISO 14692	ISO 14692
4. Pressure class or thickness	-	-	-
5. End connections	-	-	-
6. Size Range (NPS)	1" - 1 ½"	-	1" - 6"
7. Additional requirement	-	-	-

Commodity Code	C52-55	C52-56	C52-57
Specs		B26	B27
1. Fitting type	Threaded Saddle Flg	Threaded Saddle Flg	Threaded Saddle Flg
2. Material	FRP - Bisphenol A Epoxy vinylester resins reinforced with fiberglass type E or E-CR. Design pressure 16bar@90°C.	FRP - Bisphenol A Epoxy resins reinforced with fiberglass type E or E-CR. Design pressure 16bar@120°C	FRP - Epoxy vinylester resins (bisphenol A or brominated) reinforced with fiberglass type E-CR, inner liner with fiberglass veils type C. Design pressure 16bar@85°C
3. Standard	ISO 14692	ISO 14692	ISO 14692
4. Pressure class or thickness	-	-	-
5. End connections	-	-	-
6. Size Range (NPS)	-	1" - 1 ½"	1" - 1 ½"
7. Additional requirement	-	-	-

Commodity Code	C52-64
Specs	C23
1. Fitting type	Threaded Saddle Flg
2. Material	FRP - Bisphenol A Epoxy resins reinforced with fiberglass type E or E-CR. Design pressure 25bar@90°C
3. Standard	ISO 14692
4. Pressure class or thickness	-
5. End connections	-
6. Size Range (NPS)	1" - 1 ½"
7. Additional requirement	-

B12.2.39 SOCKOLET

Commodity Code	C55-02	C55-04	C55-14
Specs	B4 B9 B10 C4 C8 C9 C10 E8 E9 E10 F10 G10P	B6 B19 C6 C19 E6 E19 F6	
1. Fitting type	Socketlet	Socketlet	Socketlet
2. Material	ASTM A105	ASTM A350 Gr LF2 Cl 1	ASTM A182 Gr F316L
3. Standard	MSS SP-97	MSS SP-97	MSS SP-97
4. Pressure class or thickness	3000, 6000 2" - 24" 9000	3000, 6000	3000, 6000
5. End connections	Socket weld	Socket weld	Socket weld
6. Size Range (NPS)	½" - 1 ½"	½" - 1 ½"	½" - 1 ½"
7. Additional requirement	-	-	-

Commodity Code	C55-27	C55-30	C55-33
Specs	B16 C16 E16	B12 C12	B30 C30 E30 E32
1. Fitting type	Socketlet	Socketlet	Socketlet
2. Material	ASTM A182 Gr F51 (UNS S31803)	ASTM A182 Gr F55 (UNS S32760)	ASTM B366 (UNS N06625)
3. Standard	MSS SP-97	MSS SP-97	MSS SP-97
4. Pressure class or thickness	3000, 6000	3000, 6000	3000, 6000
5. End connections	Socket weld	Socket weld	Socket weld
6. Size Range (NPS)	½" - 1 ½"	½" - 1 ½"	½" - 1 ½"
7. Additional requirement	-	-	-

Commodity Code	C55-35	C55-43	C55-62
Specs	B7R B7	B3 C3 E3 F3 G3	B50
1. Fitting type	Socketlet	Socketlet	Socketlet
2. Material	Cu-Ni 90/10 (UNS C70620)	ASTM A182 Gr F316/316L	ASTM A182 Gr F310H
3. Standard	EEMUA 234	MSS SP-97	MSS SP-97
4. Pressure class or thickness	-	3000	3000, 6000
5. End connections	Capillary	Socket weld	Socket weld
6. Size Range (NPS)	½" - 2"	½" - 1 ½"	½" - 1 ½"
7. Additional requirement	-	-	-

B12.2.40 REDUCER BUSHING

Commodity Code	C56-50	C56-51
Specs	B20	B21
1. Fitting type	Reducer Bushing	Reducer Bushing
2. Material	PVC - ASTM D1784 class 12454	CPVC - ASTM D1784 class 23447
3. Standard	ASTM D2467	ASTM F439
4. Pressure class or thickness	-	-
5. End connections	-	-
6. Size Range (NPS)	¾" - 8"	¾" - 8"
7. Additional requirement	-	-

B12.2.41 COMPRESSION FITTING

Commodity Code	C60-40	C60-47
Specs	T3	T12
1. Fitting type	Compression Fitting	Compression Fitting
2. Material	Compression fitting with double ferrule, body AISI 316, ferrules and nuts in AISI 316.	Compression fitting with double ferrule, body/nut/ferrule SuperDuplex UNS 32760
3. Standard	according to manufacturer	according to manufacturer
4. Pressure class or thickness	6000	10000
5. End connections	Outside Diameter x NPT Thread, Outside Diameter x Outside Diameter, Outside Diameter x Socket Weld	Outside Diameter x NPT Thread, Outside Diameter x Outside Diameter, Outside Diameter x Socket Weld
6. Size Range (NPS)	¼" - 1 ½"	½" - ¾"
7. Additional requirement	-	-

B12.2.42 CONCENTRIC REDUCING, FRP

Commodity Code	C61-52	C61-53	C61-54
Specs	B22		B23
1. Fitting type	Concentric Reducing, FRP	Concentric Reducing, FRP	Concentric Reducing, FRP
2. Material	FRP - Bisphenol A Epoxy resins reinforced with fiberglass type E or E-CR. Design pressure 10bar@90°C	FRP - Bisphenol A Epoxy vinylester resins reinforced with fiberglass type E or E-CR. Design pressure 10bar@90°C.	FRP - Bisphenol A Epoxy resins reinforced with fiberglass type E or E-CR. Design pressure 16bar@90°C
3. Standard	ISO 14692	ISO 14692	ISO 14692
4. Pressure class or thickness	10 bar	-	16 bar
5. End connections	Bell-Spigot, Butt-Strap	-	Bell-Spigot, Butt-Strap
6. Size Range (NPS)	2" - 40"	-	2" - 46"
7. Additional requirement	-	-	-

Commodity Code	C61-55	C61-56	C61-57
Specs		B26	B27
1. Fitting type	Concentric Reducing, FRP	Concentric Reducing, FRP	Concentric Reducing, FRP
2. Material	FRP - Bisphenol A Epoxy vinylester resins reinforced with fiberglass type E or E-CR. Design pressure 16bar@90°C.	FRP - Bisphenol A Epoxy resins reinforced with fiberglass type E or E-CR. Design pressure 16bar@120°C	FRP - Epoxy vinylester resins (bisphenol A or brominated) reinforced with fiberglass type E-CR, inner liner with fiberglass veils type C. Design pressure 16bar@85°C
3. Standard	ISO 14692	ISO 14692	ISO 14692
4. Pressure class or thickness	-	16 bar	16 bar
5. End connections	-	Bell-Spigot, Butt-Strap	Bell-Spigot, Butt-Strap
6. Size Range (NPS)	-	2" - 36"	2" - 6"
7. Additional requirement	-	-	-

Commodity Code	C61-64
Specs	C23
1. Fitting type	Concentric Reducing, FRP
2. Material	FRP - Bisphenol A Epoxy resins reinforced with fiberglass type E or E-CR. Design pressure 25bar@90°C
3. Standard	ISO 14692
4. Pressure class or thickness	25 bar
5. End connections	Bell-Spigot, Butt-Strap
6. Size Range (NPS)	2" - 28"
7. Additional requirement	-

B12.2.43 ECCENTRIC REDUCING, FRP

Commodity Code	C62-52	C62-53	C62-54
Specs	B22		B23
1. Fitting type	Eccentric Reducing, FRP	Eccentric Reducing, FRP	Eccentric Reducing, FRP
2. Material	FRP - Bisphenol A Epoxy resins reinforced with fiberglass type E or E-CR. Design pressure 10bar@90°C	FRP - Bisphenol A Epoxy vinylester resins reinforced with fiberglass type E or E-CR. Design pressure 10bar@90°C.	FRP - Bisphenol A Epoxy resins reinforced with fiberglass type E or E-CR. Design pressure 16bar@90°C
3. Standard	ISO 14692	ISO 14692	ISO 14692
4. Pressure class or thickness	10 bar	-	16 bar
5. End connections	Bell-Spigot, Butt-Strap	-	Bell-Spigot, Butt-Strap
6. Size Range (NPS)	2" - 40"	-	2" - 46"
7. Additional requirement	-	-	-

Commodity Code	C62-55	C62-56	C62-57
Specs		B26	B27
1. Fitting type	Eccentric Reducing, FRP	Eccentric Reducing, FRP	Eccentric Reducing, FRP
2. Material	FRP - Bisphenol A Epoxy vinylester resins reinforced with fiberglass type E or E-CR. Design pressure 16bar@90°C.	FRP - Bisphenol A Epoxy resins reinforced with fiberglass type E or E-CR. Design pressure 16bar@120°C	FRP - Epoxy vinylester resins (bisphenol A or brominated) reinforced with fiberglass type E-CR, inner liner with fiberglass veils type C. Design pressure 16bar@85°C
3. Standard	ISO 14692	ISO 14692	ISO 14692
4. Pressure class or thickness	-	16 bar	16 bar
5. End connections	-	Bell-Spigot, Butt-Strap	Bell-Spigot, Butt-Strap
6. Size Range (NPS)	-	2" - 36"	2" - 6"
7. Additional requirement	-	-	-

Commodity Code	C62-64
Specs	C23
1. Fitting type	Eccentric Reducing, FRP
2. Material	FRP - Bisphenol A Epoxy resins reinforced with fiberglass type E or E-CR. Design pressure 25bar@90°C
3. Standard	ISO 14692
4. Pressure class or thickness	25 bar
5. End connections	Bell-Spigot, Butt-Strap
6. Size Range (NPS)	2" - 28"
7. Additional requirement	-

B12.2.44 FRP REDUCING TEE

Commodity Code	C63-52	C63-53	C63-54
Specs	B22		B23
1. Fitting type	FRP Reducing Tee	FRP Reducing Tee	FRP Reducing Tee
2. Material	FRP - Bisphenol A Epoxy resins reinforced with fiberglass type E or E-CR. Design pressure 10bar@90°C	FRP - Bisphenol A Epoxy vinylester resins reinforced with fiberglass type E or E-CR. Design pressure 10bar@90°C.	FRP - Bisphenol A Epoxy resins reinforced with fiberglass type E or E-CR. Design pressure 16bar@90°C
3. Standard	ISO 14692	ISO 14692	ISO 14692
4. Pressure class or thickness	10 bar	-	16 bar
5. End connections	Bell-Spigot, Butt-Strap	-	Bell-Spigot, Butt-Strap
6. Size Range (NPS)	2" - 40"	-	2" - 46"
7. Additional requirement	-	-	-

Commodity Code	C63-55	C63-56	C63-57
Specs		B26	B27
1. Fitting type	FRP Reducing Tee	FRP Reducing Tee	FRP Reducing Tee
2. Material	FRP - Bisphenol A Epoxy vinylester resins reinforced with fiberglass type E or E-CR. Design pressure 16bar@90°C.	FRP - Bisphenol A Epoxy resins reinforced with fiberglass type E or E-CR. Design pressure 16bar@120°C	FRP - Epoxy vinylester resins (bisphenol A or brominated) reinforced with fiberglass type E-CR, inner liner with fiberglass veils type C. Design pressure 16bar@85°C
3. Standard	ISO 14692	ISO 14692	ISO 14692
4. Pressure class or thickness	-	16 bar	16 bar
5. End connections	-	Bell-Spigot, Butt-Strap	Bell-Spigot, Butt-Strap
6. Size Range (NPS)	-	2" - 36"	2" - 3"
7. Additional requirement	-	-	-

Commodity Code	C63-64
Specs	C23
1. Fitting type	FRP Reducing Tee
2. Material	FRP - Bisphenol A Epoxy resins reinforced with fiberglass type E or E-CR. Design pressure 25bar@90°C
3. Standard	ISO 14692
4. Pressure class or thickness	25 bar
5. End connections	Bell-Spigot, Butt-Strap
6. Size Range (NPS)	2" - 28"
7. Additional requirement	-

B12.2.45 FRP STUB END

Commodity Code	C64-54		C64-55		C64-56	
Specs	B23				B26	
1. Fitting type	FRP Stub End		FRP Stub End		FRP Stub End	
2. Material	FRP - Bisphenol A Epoxy resins reinforced with fiberglass type E or E-CR. Design pressure 16bar@90°C		FRP - Bisphenol A Epoxy vinylester resins reinforced with fiberglass type E or E-CR. Design pressure 16bar@90°C.		FRP - Bisphenol A Epoxy resins reinforced with fiberglass type E or E-CR. Design pressure 16bar@120°C	
3. Standard	ISO 14692		ISO 14692		ISO 14692	
4. Pressure class or thickness	1"	16 bar	-	1"	Bell-Spigot, Butt-Strap	
	1 ½"	16 bar, Butt-Strap	-	1 ½" - 2"	16 bar, Bell-Spigot, Butt-Strap	
	2"	16 bar, Bell-Spigot, Butt-Strap, Butt-Strap16 bar	-	2 ½"	16 bar, Bell-Spigot, Butt-Strap, Butt-Strap16 bar	
	2 ½"	16 bar, Butt-Strap, Butt-Strap16 bar	-	3" - 30"	16 bar, Bell-Spigot, Bell-Spigot16 bar, Butt-Strap, Butt-Strap16 bar	
	3" - 26"	16 bar, Bell-Spigot16 bar, Butt-Strap, Butt-Strap16 bar	-	32"	16 bar, Bell-Spigot, Bell-Spigot16 bar, Butt-Strap	
	28" - 38"	16 bar, Bell-Spigot16 bar, Butt-Strap16 bar	-	34"	16 bar, Bell-Spigot16 bar, Butt-Strap	
	40" - 42"	16 bar, Bell-Spigot16 bar	-	36"	16 bar, Bell-Spigot16 bar	
	44"	Bell-Spigot16 bar	-			
5. End connections	Bell-Spigot, Butt-Strap		-		Bell-Spigot, Butt-Strap	
6. Size Range (NPS)	1" - 44"		-		1" - 36"	
7. Additional requirement	-		-		-	

Commodity Code	C64-57		C64-64	
Specs			C23	
1. Fitting type	FRP Stub End		FRP Stub End	
2. Material	FRP - Epoxy vinylester resins (bisphenol A or brominated) reinforced with fiberglass type E-CR, inner liner with fiberglass veils type C. Design pressure 16bar@85°C		FRP - Bisphenol A Epoxy resins reinforced with fiberglass type E or E-CR. Design pressure 25bar@90°C	
3. Standard	ISO 14692		ISO 14692	
4. Pressure class or thickness	-	-	1 ½"	Bell-Spigot, Butt-Strap
	-	-	2"	Bell-Spigot, Bell-Spigot25 bar
	-	-	2 ½" - 3"	25 bar, Bell-Spigot, Bell-Spigot25 bar
	-	-	4" - 24"	25 bar, Bell-Spigot, Bell-Spigot25 bar, Butt-Strap25 bar
	-	-	26"	25 bar, Bell-Spigot25 bar, Butt-Strap25 bar
	-	-	28"	25 bar, Butt-Strap25 bar
5. End connections	-		Bell-Spigot, Butt-Strap	
6. Size Range (NPS)	-		1" - 28"	
7. Additional requirement	-		-	

3. NIPPLE

B12.3.1 CONNECTOR NIPPLE

Commodity Code	N-A335	N-A735	N-A835
Specs	B7R B7	B7R B7	B7R B7
1. Nipple type	Connector Nipple	Connector Nipple	Connector Nipple
2. Material	Cu-Ni 90/10 (UNS C70620)	Cu-Ni 90/10 (UNS C70620)	Cu-Ni 90/10 (UNS C70620)
3. Standard	EEMUA 234	EEMUA 234	EEMUA 234
4. Schedule (SCH) or thickness	-	-	-
5. End connections	Threaded NPT Both Ends	Female NPT Thread x Female Capilar	Male NPT Thread x Female Capilar
6. Size Range (NPS)	¾" - 1 ½"	¾" - 1 ½"	¾" - 1 ½"
7. Additional requirement	-	-	-

B12.3.2 SWAGE CONCENTRIC NIPPLE

Commodity Code	N-C103	N-C105	N-C129
Specs	B4 B9 B10 C4 C8 C9 C10 E8 E9 E10 F10	B6 B19 C6 C19 E6 E19 F6	B16 C16 E16
1. Nipple type	Swage Concentric Nipple	Swage Concentric Nipple	Swage Concentric Nipple
2. Material	ASTM A234 Gr WPB	ASTM A420 Gr WPL6	ASTM A815 (UNS S31803)
3. Standard	MSS SP-95	MSS SP-95	MSS SP-95
4. Schedule (SCH) or thickness	-	-	-
5. End connections	Plain Both Ends	Plain Both Ends	Plain Both Ends
6. Size Range (NPS)	¾" - 1 ½"	¾" - 1 ½"	¾" - 1 ½"
7. Additional requirement	-	-	-

Commodity Code	N-C132	N-C133	N-C144
Specs	B12 C12	B30 C30 E30 E32	B3 C3 E3 F3 G3
1. Nipple type	Swage Concentric Nipple	Swage Concentric Nipple	Swage Concentric Nipple
2. Material	ASTM A815 (UNS S32760)	ASTM B366 (UNS N06625)	ASTM A403 Gr WP316/316L
3. Standard	MSS SP-95	MSS SP-95	ASTM F1387
4. Schedule (SCH) or thickness	-	-	-
5. End connections	Plain Both Ends	Plain Both Ends	Plain Both Ends
6. Size Range (NPS)	¾" - 1 ½"	¾" - 1 ½"	¾" - 1 ½"
7. Additional requirement	-	-	-

Commodity Code	N-C203	N-C205	N-C222
Specs	B11 B14 C11 H10	H6	H10
1. Nipple type	Swage Concentric Nipple	Swage Concentric Nipple	Swage Concentric Nipple
2. Material	ASTM A234 Gr WPB	ASTM A420 Gr WPL6	ASTM A860 WPHY65
3. Standard	MSS SP-95	MSS SP-95	MSS SP-95
4. Schedule (SCH) or thickness	-	-	-
5. End connections	Bevel Both Ends	Bevel Both Ends	Bevel Both Ends
6. Size Range (NPS)	1 ½" - 4"	2" - 4"	1 ½" - 4"
7. Additional requirement	-	-	-

Commodity Code	N-C229	N-C232	N-C233
Specs	H16	H12 J12P J12	H30P H30 J40P J40
1. Nipple type	Swage Concentric Nipple	Swage Concentric Nipple	Swage Concentric Nipple
2. Material	ASTM A815 (UNS S31803)	ASTM A815 (UNS S32760)	ASTM B366 (UNS N06625)
3. Standard	MSS SP-95	MSS SP-95	MSS SP-95
4. Schedule (SCH) or thickness	-	-	-
5. End connections	Bevel Both Ends	Bevel Both Ends	Bevel Both Ends
6. Size Range (NPS)	1 ½" - 4"	1 ½" - 4"	1 ½" - 4"
7. Additional requirement	-	-	-

Commodity Code	N-C244	N-C403	N-C405
Specs	H3	B4 B9 B10 C4 C8 C9 C10 E8	B6 B19 C6 C19 E6 E19 F6
1. Nipple type	Swage Concentric Nipple	Swage Concentric Nipple	Swage Concentric Nipple
2. Material	ASTM A403 Gr WP316/316L	ASTM A234 Gr WPB	ASTM A420 Gr WPL6
3. Standard	ASTM F1387	MSS SP-95	MSS SP-95
4. Schedule (SCH) or thickness	-	-	-
5. End connections	Bevel Both Ends	Bevel Large End x Plain Small End	Bevel Large End x Plain Small End
6. Size Range (NPS)	-	2" - 4"	2" - 4"
7. Additional requirement	-	-	-

Commodity Code	N-C422	N-C429	N-C432
Specs	E9 E10 F10	B16 C16 E16	B12 C12
1. Nipple type	Swage Concentric Nipple	Swage Concentric Nipple	Swage Concentric Nipple
2. Material	ASTM A860 WPHY65	ASTM A815 (UNS S31803)	ASTM A815 (UNS S32760)
3. Standard	MSS SP-95	MSS SP-95	MSS SP-95
4. Schedule (SCH) or thickness	-	-	-
5. End connections	Bevel Large End x Plain Small End	Bevel Large End x Plain Small End	Bevel Large End x Plain Small End
6. Size Range (NPS)	2" - 4"	2" - 4"	2" - 4"
7. Additional requirement	-	-	-

Commodity Code	N-C433	N-C444	N-C602
Specs	B30 C30 E30 E32	B3 C3 E3 F3 G3	S9B S9C
1. Nipple type	Swage Concentric Nipple	Swage Concentric Nipple	Swage Concentric Nipple
2. Material	ASTM B366 (UNS N06625)	ASTM A403 Gr WP316/316L	ASTM A105
3. Standard	MSS SP-95	MSS SP-95	ASTM F1387
4. Schedule (SCH) or thickness	-	-	-
5. End connections	Bevel Large End x Plain Small End	Bevel Large End x Plain Small End	MAF
6. Size Range (NPS)	2" - 4"	2" - 4"	¾" - 2"
7. Additional requirement	-	-	-

Commodity Code	N-C626	N-C634
Specs	S3B S3C	S7
1. Nipple type	Swage Concentric Nipple	Swage Concentric Nipple
2. Material	ASTM A182 Gr F316	Cu-Ni 70/30
3. Standard	ASTM F1387	ASTM F1387
4. Schedule (SCH) or thickness	-	-
5. End connections	MAF	MAF
6. Size Range (NPS)	¾" - 2"	¾" - 2"
7. Additional requirement	-	-

B12.3.3 SWAGE ECCENTRIC NIPPLE

Commodity Code	N-E103	N-E105	N-E129
Specs	B4 B9 B10 C4 C8 C9 C10 E8 E9 E10 F10	B6 B19 C6 C19 E6 E19 F6	B16 C16 E16
1. Nipple type	Swage Eccentric Nipple	Swage Eccentric Nipple	Swage Eccentric Nipple
2. Material	ASTM A234 Gr WPB	ASTM A420 Gr WPL6	ASTM A815 (UNS S31803)
3. Standard	MSS SP-95	MSS SP-95	MSS SP-95
4. Schedule (SCH) or thickness	-	-	-
5. End connections	Plain Both Ends	Plain Both Ends	Plain Both Ends
6. Size Range (NPS)	¾" - 1 ½"	¾" - 1 ½"	¾" - 1 ½"
7. Additional requirement	-	-	-

Commodity Code	N-E132	N-E133	N-E144
Specs	B12 C12	B30 C30 E30 E32	B3 C3 E3 F3 G3
1. Nipple type	Swage Eccentric Nipple	Swage Eccentric Nipple	Swage Eccentric Nipple
2. Material	ASTM A815 (UNS S32760)	ASTM B366 (UNS N06625)	ASTM A403 Gr WP316/316L
3. Standard	MSS SP-95	MSS SP-95	-
4. Schedule (SCH) or thickness	-	-	-
5. End connections	Plain Both Ends	Plain Both Ends	Plain Both Ends
6. Size Range (NPS)	¾" - 1 ½"	¾" - 1 ½"	¾" - 1 ½"
7. Additional requirement	-	-	-

Commodity Code	N-E203	N-E205	N-E222
Specs	B11 B14 C11 H10	H6	H10
1. Nipple type	Swage Eccentric Nipple	Swage Eccentric Nipple	Swage Eccentric Nipple
2. Material	ASTM A234 Gr WPB	ASTM A420 Gr WPL6	ASTM A860 WPHY65
3. Standard	MSS SP-95	MSS SP-95	MSS SP-95
4. Schedule (SCH) or thickness	-	-	-
5. End connections	Bevel Both Ends	Bevel Both Ends	Bevel Both Ends
6. Size Range (NPS)	1 ½" - 4"	2" - 4"	1 ½" - 4"
7. Additional requirement	-	-	-

Commodity Code	N-E229	N-E232	N-E233
Specs	H16	H12 J12P J12	H30P H30 J40P J40
1. Nipple type	Swage Eccentric Nipple	Swage Eccentric Nipple	Swage Eccentric Nipple
2. Material	ASTM A815 (UNS S31803)	ASTM A815 (UNS S32760)	ASTM B366 (UNS N06625)
3. Standard	MSS SP-95	MSS SP-95	MSS SP-95
4. Schedule (SCH) or thickness	-	-	-
5. End connections	Bevel Both Ends	Bevel Both Ends	Bevel Both Ends
6. Size Range (NPS)	1 ½" - 4"	1 ½" - 4"	1 ½" - 4"
7. Additional requirement	-	-	-

Commodity Code	N-E244	N-E403	N-E405
Specs	H3	B4 B9 B10 C4 C8 C9 C10 E8	B6 B19 C6 C19 E6 E19 F6
1. Nipple type	Swage Eccentric Nipple	Swage Eccentric Nipple	Swage Eccentric Nipple
2. Material	ASTM A403 Gr WP316/316L	ASTM A234 Gr WPB	ASTM A420 Gr WPL6
3. Standard	-	MSS SP-95	MSS SP-95
4. Schedule (SCH) or thickness	-	-	-
5. End connections	Bevel Both Ends	Bevel Large End x Plain Small End	Bevel Large End x Plain Small End
6. Size Range (NPS)	-	2" - 4"	2" - 4"
7. Additional requirement	-	-	-

Commodity Code	N-E422	N-E429	N-E432
Specs	E9 E10 F10	B16 C12 C16 E16	B12
1. Nipple type	Swage Eccentric Nipple	Swage Eccentric Nipple	Swage Eccentric Nipple
2. Material	ASTM A860 WPHY65	ASTM A815 (UNS S31803)	ASTM A815 (UNS S32760)
3. Standard	MSS SP-95	MSS SP-95	MSS SP-95
4. Schedule (SCH) or thickness	-	-	-
5. End connections	Bevel Large End x Plain Small End	Bevel Large End x Plain Small End	Bevel Large End x Plain Small End
6. Size Range (NPS)	2" - 4"	2" - 4"	2" - 4"
7. Additional requirement	-	-	-

Commodity Code	N-E433	N-E444
Specs	B30 C30 E30 E32	B3 C3 E3 F3 G3
1. Nipple type	Swage Eccentric Nipple	Swage Eccentric Nipple
2. Material	ASTM B366 (UNS N06625)	ASTM A403 Gr WP316/316L
3. Standard	MSS SP-95	MSS SP-95
4. Schedule (SCH) or thickness	-	-
5. End connections	Bevel Large End x Plain Small End	Bevel Large End x Plain Small End
6. Size Range (NPS)	¾" - 4"	2" - 4"
7. Additional requirement	-	-

B12.3.4 STRAIGHT NIPPLE

Commodity Code	N-S120	N-S123	N-S128
Specs	B4 B9 B10 C4 C8 C9 C10 E8 E9 E10 F10 G10P		B16 C16 E16
1. Nipple type	Straight Nipple	Straight Nipple	Straight Nipple
2. Material	API 5L Gr B PSL 1 seamless	ASTM A333 Gr 8	ASTM A790 (UNS S31803)
3. Standard	ASTM A733	ASTM A733	ASTM A733
4. Schedule (SCH) or thickness	-	-	-
5. End connections	Plain Both Ends	Plain Both Ends	Plain Both Ends
6. Size Range (NPS)	½" - 1 ½"	-	½" - 1 ½"
7. Additional requirement	-	-	-

Commodity Code	N-S131	N-S137	N-S139
Specs	B12 C12	B6 B19 C6 C19 E6 E19 F6	B30 C30 E30 E32
1. Nipple type	Straight Nipple	Straight Nipple	Straight Nipple
2. Material	ASTM A790 (UNS S32760)	ASTM A333 Gr 6	ASTM B444 Gr 1 (UNS N06625)
3. Standard	ASTM A733	ASTM A733	ASTM A733
4. Schedule (SCH) or thickness	-	-	-
5. End connections	Plain Both Ends	Plain Both Ends	Plain Both Ends
6. Size Range (NPS)	½" - 1 ½"	½" - 1 ½"	½" - 1 ½"
7. Additional requirement	-	-	-

Commodity Code	N-S140	N-S141	N-S145
Specs		B50	B3 C3 E3 F3 G3
1. Nipple type	Straight Nipple	Straight Nipple	Straight Nipple
2. Material	Straight Nipple, NPT nut, ASTM A312 Grade TP 316, SC, ASTM A733	ASTM A312 TP310H	ASTM A312 TP316/316L
3. Standard	-	ASTM A733	ASTM A733
4. Schedule (SCH) or thickness	-	-	-
5. End connections	Plain Both Ends	Plain Both Ends	Plain Both Ends
6. Size Range (NPS)	-	½" - 1 ½"	½" - 1 ½"
7. Additional requirement	-	-	-

Commodity Code	N-S150	N-S151	N-S220
Specs	B20	B21	H10
1. Nipple type	Straight Nipple	Straight Nipple	Straight Nipple
2. Material	PVC - ASTM D1785 class 1120	CPVC - ASTM F441 class 4120	API 5L Gr B PSL 1 seamless
3. Standard	ASTM D1785	ASTM F441	ASTM A733
4. Schedule (SCH) or thickness	-	-	-
5. End connections	Plain Both Ends	Plain Both Ends	Bevel Both Ends
6. Size Range (NPS)	½" - 8"	½" - 8"	1" - 1 ½"
7. Additional requirement	-	-	-

Commodity Code	N-S228	N-S231	N-S237
Specs	H16	H12P H12 J12P J12	H6
1. Nipple type	Straight Nipple	Straight Nipple	Straight Nipple
2. Material	ASTM A790 (UNS S31803)	ASTM A790 (UNS S32760)	ASTM A333 Gr 6
3. Standard	ASTM A733	ASTM A733	ASTM A733
4. Schedule (SCH) or thickness	-	-	-
5. End connections	Bevel Both Ends	Bevel Both Ends	Bevel Both Ends
6. Size Range (NPS)	1" - 1 ½"	1" - 1 ½"	1" - 1 ½"
7. Additional requirement	-	-	-

Commodity Code	N-S239	N-S245
Specs	H30P H30 J40P J40	H3
1. Nipple type	Straight Nipple	Straight Nipple
2. Material	ASTM B444 Gr 1 (UNS N06625)	ASTM A312 TP316/316L
3. Standard	ASTM A733	ASTM A733
4. Schedule (SCH) or thickness	-	-
5. End connections	Bevel Both Ends	Bevel Both Ends
6. Size Range (NPS)	1" - 1 ½"	-
7. Additional requirement	-	-

4. FLANGES

B12.4.1 INTEGRAL FRP FLANGE

Commodity Code	F-10-1T	F-16-1S	F-16-1U
Specs	B22	B27	
1. Flange type	Integral FRP Flange	Integral FRP Flange	Integral FRP Flange
2. Material	FRP - Bisphenol A Epoxy resins reinforced with fiberglass type E or E-CR. Suitable for 90°C.	FRP - Epoxy vinyl ester resins (bisphenol A or brominated) reinforced with fiberglass type E-CR. Suitable for 85°C.	FRP - Bisphenol A Epoxy resins reinforced with fiberglass type E or E-CR. Suitable for 120°C.
3. Standard	ASTM D4024 - Drilling acc. B16.5/B16.47 CL150	ASTM D4024 - Drilling acc. B16.5/B16.47 CL150	ASTM D4024 - Drilling acc. B16.5/B16.47 CL150
4. Pressure class	10 bar	16 bar	16 bar
5. Flange facing	Flat Face	Flat Face	Flat Face
6. Face finishing	-	-	-
7. Coating	-	-	-
8. Schedule (SCH) or thickness	-	-	-
9. Size Range (NPS)	1" - 40"	1" - 6"	-
10. Additional requirement	-	-	-

B12.4.2 BLIND FLANGE

Commodity Code	F-10-ET	F-1500-S2	F-1500-S3
Specs	B22	F10 G10P	F6
1. Flange type	Blind Flange	Blind Flange	Blind Flange
2. Material	FRP - Bisphenol A Epoxy resins reinforced with fiberglass type E or E-CR. Suitable for 90°C.	ASTM A105	ASTM A350 Gr LF2 Class 1
3. Standard	ASTM D4024 - Drilling acc. B16.5/B16.47 CL150	ASME B16.5	ASME B16.5
4. Pressure class	10 bar	Class 1500	Class 1500
5. Flange facing	Flat Face	Ring Type Joint	Ring Type Joint
6. Face finishing	-	Surface finish not exceed 63 µm.	Surface finish not exceed 63 µm.
7. Coating	-	-	-
8. Schedule (SCH) or thickness	-	-	-
9. Size Range (NPS)	1" - 40"	½" - 10"	½" - 18"
10. Additional requirement	-	-	-

Commodity Code	F-1500-SC	F-1500-SX	F-150-E2
Specs	F10 G10P	F3 G3	B14
1. Flange type	Blind Flange	Blind Flange	Blind Flange
2. Material	ASTM A694 Gr F65	ASTM A182 Gr F316/316L	ASTM A105
3. Standard	ASME B16.5	ASME B16.5	½" - 24" ASME B16.5 26" - 44" ASME B16.47 Series A
4. Pressure class	Class 1500	Class 1500	Class 150
5. Flange facing	Ring Type Joint	Ring Type Joint	Flat Face
6. Face finishing	Surface finish not exceed 63 µm.	Surface finish not exceed 63 µm.	125-250 µm. surface finish
7. Coating	-	-	-
8. Schedule (SCH) or thickness	-	-	-
9. Size Range (NPS)	2" - 24"	½" - 16"	½" - 44"
10. Additional requirement	-	-	-

Commodity Code	F-150-EP	F-150-EQ	F-150-L2
Specs	B20	B21	B4 B9 B10 B11 R9B S9B
1. Flange type	Blind Flange	Blind Flange	Blind Flange
2. Material	PVC - ASTM D1784 class 12454	CPVC-Chlorinated polyvinyl chloride, ASTM D1784 class 23447	ASTM A105
3. Standard	ASME B16.5	ASME B16.5	½" - 24" ASME B16.5 26" - 36" ASME B16.47 Series A
4. Pressure class	Class 150	Class 150	Class 150
5. Flange facing	Flat Face	Flat Face	Raised Face
6. Face finishing	-	-	125-250 µm. surface finish
7. Coating	-	-	-
8. Schedule (SCH) or thickness	-	-	-
9. Size Range (NPS)	½" - 8"	½" - 8"	½" - 36"
10. Additional requirement	-	-	-

Commodity Code	F-150-L3		F-150-LB		F-150-LF
Specs	B6 B19		B30		S3B
1. Flange type	Blind Flange		Blind Flange		Blind Flange
2. Material	ASTM A350 Gr LF2 Class 1		ASTM A105 Cladded		ASTM A182 Gr F316
3. Standard	½" - 24"	ASME B16.5	4" - 24"	ASME B16.5	ASME B16.5
	26" - 36"	ASME B16.47 Series A	26" - 30"	ASME B16.47 Series A	-
4. Pressure class	Class 150		Class 150		Class 150
5. Flange facing	Raised Face		Raised Face		Raised Face
6. Face finishing	125-250 µin. surface finish		125-250 µin. surface finish		125-250 µin. surface finish
7. Coating	-		Inconel (UNS N06625) clad		-
8. Schedule (SCH) or thickness	-		-		-
9. Size Range (NPS)	½" - 36"		4" - 30"		½" - 24"
10. Additional requirement	-		-		-

Commodity Code	F-150-LG		F-150-LH		F-150-LL
Specs	B16		B12		B30
1. Flange type	Blind Flange		Blind Flange		Blind Flange
2. Material	ASTM A182 Gr F51		ASTM A182 Gr F55		ASTM B564 (UNS N06625)
3. Standard	½" - 24"	ASME B16.5	½" - 24"	ASME B16.5	ASME B16.5
	26" - 34"	ASME B16.47 Series A	26" - 36"	ASME B16.47 Series A	-
4. Pressure class	Class 150		Class 150		Class 150
5. Flange facing	Raised Face		Raised Face		Raised Face
6. Face finishing	125-250 µin. surface finish		125-250 µin. surface finish		125-250 µin. surface finish
7. Coating	-		-		-
8. Schedule (SCH) or thickness	-		-		-
9. Size Range (NPS)	½" - 34"		½" - 36"		½" - 3"
10. Additional requirement	-		-		-

Commodity Code	F-150-LX		F-150-LY		F-16-ES
Specs	B3 R3B		B7R B7		B27
1. Flange type	Blind Flange		Blind Flange		Blind Flange
2. Material	ASTM A182 Gr F316/316L		ASTM A105 Thermal Spray coated (note 126)		FRP - Epoxy vinylester resins (bisphenol A or brominated) reinforced with fiberglass type E-CR. Suitable for 85°C.
3. Standard	½" - 24"	ASME B16.5	½" - 24"	ASME B16.5	ASTM D4024 - Drilling acc. B16.5/B16.47 CL150
	26" - 40"	ASME B16.47 Series A	28" - 36"	ASME B16.47 Series A	-
4. Pressure class	Class 150		Class 150		16 bar
5. Flange facing	Raised Face		Raised Face		Flat Face
6. Face finishing	125-250 µin. surface finish		125-250 µin. surface finish		-
7. Coating	-		-		-
8. Schedule (SCH) or thickness	-		-		-
9. Size Range (NPS)	½" - 40"		½" - 36"		1" - 6"
10. Additional requirement	-		-		-

Commodity Code	F-16-EU		F-16-LT		F-20-LN
Specs	B26		B23		S7
1. Flange type	Blind Flange		Blind Flange		Blind Flange
2. Material	FRP - Bisphenol A Epoxy resins reinforced with fiberglass type E or E-CR. Suitable for 120°C.		FRP - Bisphenol A Epoxy resins reinforced with fiberglass type E or E-CR. Suitable for 90°C.		Cu-Ni 70/30
3. Standard	ASTM D4024 - Drilling acc. B16.5/B16.47 CL150		ASTM D4024 - Drilling acc. B16.5/B16.47 CL150		ASME B16.5
4. Pressure class	16 bar		16 bar		20 bar
5. Flange facing	Flat Face		Raised Face		Raised Face
6. Face finishing	-		-		125-250 µin. surface finish
7. Coating	-		-		-
8. Schedule (SCH) or thickness	-		-		-
9. Size Range (NPS)	1" - 36"		1" - 46"		½" - 2"
10. Additional requirement	-		-		-

Commodity Code	F-2500-S2	F-2500-S3	F-2500-SC
Specs	H10	H6	H10
1. Flange type	Blind Flange	Blind Flange	Blind Flange
2. Material	ASTM A105	ASTM A350 Gr LF2 Class 1	ASTM A694 Gr F65
3. Standard	ASME B16.5	ASME B16.5	ASME B16.5
4. Pressure class	Class 2500	Class 2500	Class 2500
5. Flange facing	Ring Type Joint	Ring Type Joint	Ring Type Joint
6. Face finishing	Surface finish not exceed 63 µin.	Surface finish not exceed 63 µin.	Surface finish not exceed 63 µin.
7. Coating	-	-	-
8. Schedule (SCH) or thickness	-	-	-
9. Size Range (NPS)	1" - 1 ½"	1" - 12"	2" - 12"
10. Additional requirement	-	-	-

Commodity Code	F-2500-SD	F-2500-SG	F-2500-SH
Specs	H30P H30	H16	H12P H12
1. Flange type	Blind Flange	Blind Flange	Blind Flange
2. Material	ASTM A694 Gr F65 Cladded	ASTM A182 Gr F51	ASTM A182 Gr F55
3. Standard	ASME B16.5	ASME B16.5	ASME B16.5
4. Pressure class	Class 2500	Class 2500	Class 2500
5. Flange facing	Ring Type Joint	Ring Type Joint	Ring Type Joint
6. Face finishing	Surface finish not exceed 63 µin.	Surface finish not exceed 63 µin.	Surface finish not exceed 63 µin.
7. Coating	Inconel (UNS N06625) clad	-	-
8. Schedule (SCH) or thickness	-	-	-
9. Size Range (NPS)	1" - 12"	1" - 12"	1" - 12"
10. Additional requirement	-	-	-

Commodity Code	F-2500-SL	F-2500-SX	F-25-LT
Specs	H30P H30	H3	C23
1. Flange type	Blind Flange	Blind Flange	Blind Flange
2. Material	ASTM B564 (UNS N06625)	ASTM A182 Gr F316/316L	FRP - Bisphenol A Epoxy resins reinforced with fiberglass type E or E-CR. Suitable for 90°C.
3. Standard	ASME B16.5	ASME B16.5	ASTM D4024 - Drilling acc. B16.5/B16.47 CL300
4. Pressure class	Class 2500	Class 2500	25 bar
5. Flange facing	Ring Type Joint	Ring Type Joint	Raised Face
6. Face finishing	Surface finish not exceed 63 µin.	Surface finish not exceed 63 µin.	-
7. Coating	-	-	-
8. Schedule (SCH) or thickness	-	-	-
9. Size Range (NPS)	1" - 3"	1" - 12"	1" - 28"
10. Additional requirement	-	-	-

Commodity Code	F-300-L2	F-300-L3	F-300-LB
Specs	C4 C8 C9 C10 C11 R9C S9C	C6 C19	C30
1. Flange type	Blind Flange	Blind Flange	Blind Flange
2. Material	ASTM A105	ASTM A350 Gr LF2 Class 1	ASTM A105 Cladded
3. Standard	½" - 24" ASME B16.5 26" - 32" ASME B16.47 Series A	½" - 24" ASME B16.5 26" - 30" ASME B16.47 Series A	4" - 24" ASME B16.5 26" ASME B16.47 Series A
4. Pressure class	Class 300	Class 300	Class 300
5. Flange facing	Raised Face	Raised Face	Raised Face
6. Face finishing	125-250 µin. surface finish	125-250 µin. surface finish	125-250 µin. surface finish
7. Coating	-	-	Inconel (UNS N06625) clad
8. Schedule (SCH) or thickness	-	-	-
9. Size Range (NPS)	½" - 32"	½" - 30"	4" - 26"
10. Additional requirement	-	-	-

Commodity Code	F-300-LF	F-300-LG	F-300-LH
Specs	S3C	C16	C12
1. Flange type	Blind Flange	Blind Flange	Blind Flange
2. Material	ASTM A182 Gr F316	ASTM A182 Gr F51	ASTM A182 Gr F55
3. Standard	ASME B16.5	ASME B16.5	½" - 24" ASME B16.5 26" - 30" ASME B16.47 Series A
4. Pressure class	Class 300	Class 300	Class 300
5. Flange facing	Raised Face	Raised Face	Raised Face
6. Face finishing	125-250 µin. surface finish	125-250 µin. surface finish	125-250 µin. surface finish
7. Coating	-	-	-
8. Schedule (SCH) or thickness	-	-	-
9. Size Range (NPS)	½" - 2"	½" - 24"	½" - 30"
10. Additional requirement	-	-	-

Commodity Code	F-300-LL	F-300-LV	F-300-LW
Specs	C30		B50
1. Flange type	Blind Flange	Blind Flange	Blind Flange
2. Material	ASTM B564 (UNS N06625)	ASTM A105 Epoxy coated	ASTM A182 Gr F310H
3. Standard	ASME B16.5	-	½" - 24" ASME B16.5
	-	-	26" - 56" ASME B16.47 Series A
4. Pressure class	Class 300	Class 300	Class 300
5. Flange facing	Raised Face	Raised Face	Raised Face
6. Face finishing	125-250 µin. surface finish	125-250 µin. surface finish	125-250 µin. surface finish
7. Coating	-	-	-
8. Schedule (SCH) or thickness	-	-	-
9. Size Range (NPS)	½" - 3"	-	½" - 56"
10. Additional requirement	-	-	-

Commodity Code	F-300-LX	F-300-SW	F-350-4X
Specs	C3 R3C		B3 C3 E3 F3 G3
1. Flange type	Blind Flange	Blind Flange	Blind Flange
2. Material	ASTM A182 Gr F316/316L	ASTM A182 Gr F310H	ASTM A182 Gr F316/316L
3. Standard	½" - 24" ASME B16.5	½" - 24" ASME B16.5	ISO 6162-1
	26" - 30" ASME B16.47 Series A	26" - 36" ASME B16.47 Series A	-
4. Pressure class	Class 300	Class 300	max 350 bar
5. Flange facing	Raised Face	Ring Type Joint	-
6. Face finishing	125-250 µin. surface finish	Surface finish not exceed 63 µin.	-
7. Coating	-	-	-
8. Schedule (SCH) or thickness	-	-	-
9. Size Range (NPS)	½" - 30"	½" - 36"	½" - 3"
10. Additional requirement	-	-	-

Commodity Code	F-420-4X	F-600-L2	F-600-L3
Specs	H3	E8 E9 E10	E6 E19
1. Flange type	Blind Flange	Blind Flange	Blind Flange
2. Material	ASTM A182 Gr F316/316L	ASTM A105	ASTM A350 Gr LF2 Class 1
3. Standard	ISO 6162-2	ASME B16.5	ASME B16.5
4. Pressure class	max 420 bar	Class 600	Class 600
5. Flange facing	-	Raised Face	Raised Face
6. Face finishing	-	125-250 µin. surface finish	125-250 µin. surface finish
7. Coating	-	-	-
8. Schedule (SCH) or thickness	-	-	-
9. Size Range (NPS)	1" - 3"	½" - 8"	½" - 24"
10. Additional requirement	-	-	-

Commodity Code	F-600-LC	F-600-LE	F-600-LG
Specs	E9 E10 E30	E32	E16
1. Flange type	Blind Flange	Blind Flange	Blind Flange
2. Material	ASTM A694 Gr F65	ASTM A350 Gr LF3 Cladded	ASTM A182 Gr F51
3. Standard	ASME B16.5	ASME B16.5	ASME B16.5
4. Pressure class	Class 600	Class 600	Class 600
5. Flange facing	Raised Face	Raised Face	Raised Face
6. Face finishing	125-250 µin. surface finish	125-250 µin. surface finish	125-250 µin. surface finish
7. Coating	-	Inconel (UNS N06625) clad	-
8. Schedule (SCH) or thickness	-	-	-
9. Size Range (NPS)	2" - 24"	4" - 16"	½" - 16"
10. Additional requirement	-	-	-

Commodity Code	F-600-LL	F-600-LX	F-600-S3
Specs	E30 E32	E3	
1. Flange type	Blind Flange	Blind Flange	Blind Flange
2. Material	ASTM B564 (UNS N06625)	ASTM A182 Gr F316/316L	ASTM A350 Gr LF2 Class 1
3. Standard	ASME B16.5	ASME B16.5	-
4. Pressure class	Class 600	Class 600	Class 600
5. Flange facing	Raised Face	Raised Face	Ring Type Joint
6. Face finishing	125-250 µin. surface finish	125-250 µin. surface finish	Surface finish not exceed 63 µin.
7. Coating	-	-	-
8. Schedule (SCH) or thickness	-	-	-
9. Size Range (NPS)	½" - 3"	½" - 24"	-
10. Additional requirement	-	-	-

Commodity Code	F-600-S7	F-600-SB	F-600-SC
Specs			
1. Flange type	Blind Flange	Blind Flange	Blind Flange
2. Material	ASTM A182 Gr F316L	ASTM A105 Cladded	ASTM A694 Gr F65
3. Standard	-	-	-
4. Pressure class	Class 600	Class 600	Class 600
5. Flange facing	Ring Type Joint	Ring Type Joint	Ring Type Joint
6. Face finishing	Surface finish not exceed 63 µin.	Surface finish not exceed 63 µin.	Surface finish not exceed 63 µin.
7. Coating	-	Inconel (UNS N06625) clad	-
8. Schedule (SCH) or thickness	-	-	-
9. Size Range (NPS)	-	-	-
10. Additional requirement	-	-	-

Commodity Code	F-600-SE	F-600-SG	F-600-SL
Specs			
1. Flange type	Blind Flange	Blind Flange	Blind Flange
2. Material	ASTM A350 Gr LF3 Cladded	ASTM A182 Gr F51	ASTM B564 (UNS N06625)
3. Standard	-	-	-
4. Pressure class	Class 600	Class 600	Class 600
5. Flange facing	Ring Type Joint	Ring Type Joint	Ring Type Joint
6. Face finishing	Surface finish not exceed 63 µin.	Surface finish not exceed 63 µin.	Surface finish not exceed 63 µin.
7. Coating	Inconel (UNS N06625) clad	-	-
8. Schedule (SCH) or thickness	-	-	-
9. Size Range (NPS)	-	-	-
10. Additional requirement	-	-	-

Commodity Code	F-900-S3	F-900-SB	F-900-SC
Specs	F6		F10
1. Flange type	Blind Flange	Blind Flange	Blind Flange
2. Material	ASTM A350 Gr LF2 Class 1	ASTM A105 Cladded	ASTM A694 Gr F65
3. Standard	ASME B16.5	-	3" - 24" ASME B16.5 26" - 34" ASME B16.47 Series A
4. Pressure class	Class 900	Class 900	Class 900
5. Flange facing	Ring Type Joint	Ring Type Joint	Ring Type Joint
6. Face finishing	Surface finish not exceed 63 µin.	Surface finish not exceed 63 µin.	Surface finish not exceed 63 µin.
7. Coating	-	Inconel (UNS N06625) clad	-
8. Schedule (SCH) or thickness	-	-	-
9. Size Range (NPS)	3" - 20"	-	3" - 34"
10. Additional requirement	-	-	-

Commodity Code	F-900-SX
Specs	F3
1. Flange type	Blind Flange
2. Material	ASTM A182 Gr F316/316L
3. Standard	ASME B16.5
4. Pressure class	Class 900
5. Flange facing	Ring Type Joint
6. Face finishing	Surface finish not exceed 63 µin.
7. Coating	-
8. Schedule (SCH) or thickness	-
9. Size Range (NPS)	3" - 18"
10. Additional requirement	-

B12.4.3 WELDING NECK FLANGE API 6BX

Commodity Code	F-10000-RH		F-10000-RL	
Specs	J12P J12		J40P J40	
1. Flange type	Welding Neck Flange API 6BX		Welding Neck Flange API 6BX	
2. Material	ASTM A182 Gr F55		ASTM B564 (UNS N06625)	
3. Standard	API 6A		API 6A	
4. Pressure class	API 10000		API 10000	
5. Flange facing	Ring Type Joint		Ring Type Joint	
6. Face finishing	Surface finish not exceed 63 µin.		Surface finish not exceed 63 µin.	
7. Coating	-		-	
8. Schedule (SCH) or thickness	-		-	
9. Size Range (NPS)	1" - 2"	1 13/16"	1" - 2"	1 13/16"
	3"	2 1/16"	3"	2 1/16"
	4"	2 9/16"	4"	2 9/16"
	6"	4 1/16"	6"	4 1/16"
	8"	5 1/8"	8"	5 1/8"
	10"	7 1/16"	10"	7 1/16"
	12" - 14"	9"	12" - 14"	9"
	16"	11"	-	-
10. Additional requirement	-		-	

B12.4.4 BLIND FLANGE API 6BX

Commodity Code	F-10000-SH		F-10000-SL	
Specs	J12P J12		J40P J40	
1. Flange type	Blind Flange API 6BX		Blind Flange API 6BX	
2. Material	ASTM A182 Gr F55		ASTM B564 (UNS N06625)	
3. Standard	API 6A		API 6A	
4. Pressure class	API 10000		API 10000	
5. Flange facing	Ring Type Joint		Ring Type Joint	
6. Face finishing	Surface finish not exceed 63 µin.		Surface finish not exceed 63 µin.	
7. Coating	-		-	
8. Schedule (SCH) or thickness	-		-	
9. Size Range (NPS)	1" - 2"	1 13/16"	1" - 2"	1 13/16"
	3"	2 1/16"	3"	2 1/16"
	4"	2 9/16"	4"	2 9/16"
	6"	4 1/16"	6"	4 1/16"
	8"	5 1/8"	8"	5 1/8"
	10"	7 1/16"	10"	7 1/16"
	12" - 14"	9"	12" - 14"	9"
	16"	11"	-	-
10. Additional requirement	-		-	

B12.4.5 SOCKET WELD FLANGE (SW)

Commodity Code	F-1500-Q2	F-1500-Q3	F-1500-QX
Specs	F10 G10P	F6	F3 G3
1. Flange type	Socket Weld Flange (SW)	Socket Weld Flange (SW)	Socket Weld Flange (SW)
2. Material	ASTM A105	ASTM A350 Gr LF2 Class 1	ASTM A182 Gr F316/316L
3. Standard	ASME B16.5	ASME B16.5	ASME B16.5
4. Pressure class	Class 1500	Class 1500	Class 1500
5. Flange facing	Ring Type Joint	Ring Type Joint	Ring Type Joint
6. Face finishing	Surface finish not exceed 63 µin.	Surface finish not exceed 63 µin.	Surface finish not exceed 63 µin.
7. Coating	-	-	-
8. Schedule (SCH) or thickness	-	-	-
9. Size Range (NPS)	½" - 1 ½"	½" - 1 ½"	½" - 1 ½"
10. Additional requirement	-	-	-

Commodity Code	F-150-CP	F-150-CQ	F-150-J2
Specs	B20	B21	B4 B9 B10
1. Flange type	Socket Weld Flange (SW)	Socket Weld Flange (SW)	Socket Weld Flange (SW)
2. Material	PVC - ASTM D1784 class 12454	CPVC-Chlorinated polyvinyl chloride, ASTM D1784 class 23447	ASTM A105
3. Standard	ASME B16.5	ASME B16.5	ASME B16.5
4. Pressure class	Class 150	Class 150	Class 150
5. Flange facing	Flat Face	Flat Face	Raised Face
6. Face finishing	-	-	125-250 µin. surface finish
7. Coating	-	-	-
8. Schedule (SCH) or thickness	-	-	-
9. Size Range (NPS)	½" - 8"	½" - 8"	½" - 1 ½"
10. Additional requirement	-	-	-

Commodity Code	F-150-J3	F-150-JG	F-150-JH
Specs	B6 B19	B16	B12
1. Flange type	Socket Weld Flange (SW)	Socket Weld Flange (SW)	Socket Weld Flange (SW)
2. Material	ASTM A350 Gr LF2 Class 1	ASTM A182 Gr F51	ASTM A182 Gr F55
3. Standard	ASME B16.5	ASME B16.5	ASME B16.5
4. Pressure class	Class 150	Class 150	Class 150
5. Flange facing	Raised Face	Raised Face	Raised Face
6. Face finishing	125-250 µin. surface finish	125-250 µin. surface finish	125-250 µin. surface finish
7. Coating	-	-	-
8. Schedule (SCH) or thickness	-	-	-
9. Size Range (NPS)	½" - 1 ½"	½" - 1 ½"	½" - 1 ½"
10. Additional requirement	-	-	-

Commodity Code	F-150-JL	F-150-JX	F-300-J2
Specs	B30	B3	C4 C9 C10
1. Flange type	Socket Weld Flange (SW)	Socket Weld Flange (SW)	Socket Weld Flange (SW)
2. Material	ASTM B564 (UNS N06625)	ASTM A182 Gr F316/316L	ASTM A105
3. Standard	ASME B16.5	ASME B16.5	ASME B16.5
4. Pressure class	Class 150	Class 150	Class 300
5. Flange facing	Raised Face	Raised Face	Raised Face
6. Face finishing	125-250 µin. surface finish	125-250 µin. surface finish	125-250 µin. surface finish
7. Coating	-	-	-
8. Schedule (SCH) or thickness	-	-	-
9. Size Range (NPS)	½" - 1 ½"	½" - 1 ½"	½" - 1 ½"
10. Additional requirement	-	-	-

Commodity Code	F-300-J3	F-300-JG	F-300-JH
Specs	C6 C19	C16	C12
1. Flange type	Socket Weld Flange (SW)	Socket Weld Flange (SW)	Socket Weld Flange (SW)
2. Material	ASTM A350 Gr LF2 Class 1	ASTM A182 Gr F51	ASTM A182 Gr F55
3. Standard	ASME B16.5	ASME B16.5	ASME B16.5
4. Pressure class	Class 300	Class 300	Class 300
5. Flange facing	Raised Face	Raised Face	Raised Face
6. Face finishing	125-250 µin. surface finish	125-250 µin. surface finish	125-250 µin. surface finish
7. Coating	-	-	-
8. Schedule (SCH) or thickness	-	-	-
9. Size Range (NPS)	½" - 1 ½"	½" - 1 ½"	½" - 1 ½"
10. Additional requirement	-	-	-

Commodity Code	F-300-JL	F-300-JW	F-300-JX
Specs	C30	B50	C3
1. Flange type	Socket Weld Flange (SW)	Socket Weld Flange (SW)	Socket Weld Flange (SW)
2. Material	ASTM B564 (UNS N06625)	ASTM A182 Gr F310H	ASTM A182 Gr F316/316L
3. Standard	ASME B16.5	ASME B16.5	ASME B16.5
4. Pressure class	Class 300	Class 300	Class 300
5. Flange facing	Raised Face	Raised Face	Raised Face
6. Face finishing	125-250 µin. surface finish	125-250 µin. surface finish	125-250 µin. surface finish
7. Coating	-	-	-
8. Schedule (SCH) or thickness	-	-	-
9. Size Range (NPS)	½" - 3"	½" - 1 ½"	½" - 1 ½"
10. Additional requirement	-	-	-

Commodity Code	F-300-QW	F-600-J2	F-600-J3
Specs		E9 E10	E6 E19
1. Flange type	Socket Weld Flange (SW)	Socket Weld Flange (SW)	Socket Weld Flange (SW)
2. Material	ASTM A182 Gr F310H	ASTM A105	ASTM A350 Gr LF2 Class 1
3. Standard	ASME B16.5	ASME B16.5	ASME B16.5
4. Pressure class	Class 300	Class 600	Class 600
5. Flange facing	Ring Type Joint	Raised Face	Raised Face
6. Face finishing	Surface finish not exceed 63 µin.	125-250 µin. surface finish	125-250 µin. surface finish
7. Coating	-	-	-
8. Schedule (SCH) or thickness	-	-	-
9. Size Range (NPS)	½" - 1 ½"	½" - 1 ½"	½" - 1 ½"
10. Additional requirement	-	-	-

Commodity Code	F-600-JG	F-600-JL	F-600-JX
Specs	E16	E30 E32	E3
1. Flange type	Socket Weld Flange (SW)	Socket Weld Flange (SW)	Socket Weld Flange (SW)
2. Material	ASTM A182 Gr F51	ASTM B564 (UNS N06625)	ASTM A182 Gr F316/316L
3. Standard	ASME B16.5	ASME B16.5	ASME B16.5
4. Pressure class	Class 600	Class 600	Class 600
5. Flange facing	Raised Face	Raised Face	Raised Face
6. Face finishing	125-250 µin. surface finish	125-250 µin. surface finish	125-250 µin. surface finish
7. Coating	-	-	-
8. Schedule (SCH) or thickness	-	-	-
9. Size Range (NPS)	½" - 1 ½"	½" - 1 ½"	½" - 1 ½"
10. Additional requirement	-	-	-

Commodity Code	F-600-Q3	F-600-Q7	F-600-QG
Specs			
1. Flange type	Socket Weld Flange (SW)	Socket Weld Flange (SW)	Socket Weld Flange (SW)
2. Material	ASTM A350 Gr LF2 Class 1	ASTM A182 Gr F316L	ASTM A182 Gr F51
3. Standard	ASME B16.5	ASME B16.5	ASME B16.5
4. Pressure class	Class 600	Class 600	Class 600
5. Flange facing	Ring Type Joint	Ring Type Joint	Ring Type Joint
6. Face finishing	Surface finish not exceed 63 µin.	Surface finish not exceed 63 µin.	Surface finish not exceed 63 µin.
7. Coating	-	-	-
8. Schedule (SCH) or thickness	-	-	-
9. Size Range (NPS)	-	-	-
10. Additional requirement	-	-	-

Commodity Code	F-600-QL
Specs	
1. Flange type	Socket Weld Flange (SW)
2. Material	ASTM B564 (UNS N06625)
3. Standard	ASME B16.5
4. Pressure class	Class 600
5. Flange facing	Ring Type Joint
6. Face finishing	Surface finish not exceed 63 µin.
7. Coating	-
8. Schedule (SCH) or thickness	-
9. Size Range (NPS)	-
10. Additional requirement	-

B12.4.6 WELDING NECK FLANGE (WN)

Commodity Code	F-1500-R3	F-1500-RC	F-1500-RX
Specs	F6	F10 G10P	F3 G3
1. Flange type	Welding Neck Flange (WN)	Welding Neck Flange (WN)	Welding Neck Flange (WN)
2. Material	ASTM A350 Gr LF2 Class 1	ASTM A694 Gr F65	ASTM A182 Gr F316/316L
3. Standard	ASME B16.5	ASME B16.5	ASME B16.5
4. Pressure class	Class 1500	Class 1500	Class 1500
5. Flange facing	Ring Type Joint	Ring Type Joint	Ring Type Joint
6. Face finishing	Surface finish not exceed 63 µin.	Surface finish not exceed 63 µin.	Surface finish not exceed 63 µin.
7. Coating	-	-	-
8. Schedule (SCH) or thickness	-	-	-
9. Size Range (NPS)	2" - 18"	2" - 24"	2" - 16"
10. Additional requirement	-	-	-

Commodity Code	F-150-D2	F-150-K2	F-150-K3
Specs	B14	B4 B9 B10 B11	B6 B19
1. Flange type	Welding Neck Flange (WN)	Welding Neck Flange (WN)	Welding Neck Flange (WN)
2. Material	ASTM A105	ASTM A105	ASTM A350 Gr LF2 Class 1
3. Standard	½" - 24" ASME B16.5 26" - 44" ASME B16.47 Series A	¾" - 24" ASME B16.5 26" - 36" ASME B16.47 Series A	2" - 24" ASME B16.5 26" - 36" ASME B16.47 Series A
4. Pressure class	Class 150	Class 150	Class 150
5. Flange facing	Flat Face	Raised Face	Raised Face
6. Face finishing	125-250 µin. surface finish	125-250 µin. surface finish	125-250 µin. surface finish
7. Coating	-	-	-
8. Schedule (SCH) or thickness	-	-	-
9. Size Range (NPS)	½" - 44"	¾" - 36"	2" - 36"
10. Additional requirement	-	-	-

Commodity Code	F-150-KB		F-150-KG		F-150-KH	
Specs	B30		B16		B12	
1. Flange type	Welding Neck Flange (WN)		Welding Neck Flange (WN)		Welding Neck Flange (WN)	
2. Material	ASTM A105 Cladded		ASTM A182 Gr F51		ASTM A182 Gr F55	
3. Standard	4" - 24"	ASME B16.5	2" - 24"	ASME B16.5	2" - 24"	ASME B16.5
	26" - 30"	ASME B16.47 Series A	26" - 34"	ASME B16.47 Series A	26" - 36"	ASME B16.47 Series A
4. Pressure class	Class 150		Class 150		Class 150	
5. Flange facing	Raised Face		Raised Face		Raised Face	
6. Face finishing	125-250 µin. surface finish		125-250 µin. surface finish		125-250 µin. surface finish	
7. Coating	Inconel (UNS N06625) clad		-		-	
8. Schedule (SCH) or thickness	-		-		-	
9. Size Range (NPS)	4" - 30"		2" - 34"		2" - 36"	
10. Additional requirement	-		-		-	

Commodity Code	F-150-KL		F-150-KX		F-2500-R2	
Specs	B30		B3		H10	
1. Flange type	Welding Neck Flange (WN)		Welding Neck Flange (WN)		Welding Neck Flange (WN)	
2. Material	ASTM B564 (UNS N06625)		ASTM A182 Gr F316/316L		ASTM A105	
3. Standard	ASME B16.5		2" - 24"	ASME B16.5	ASME B16.5	
	-		26" - 40"	ASME B16.47 Series A	-	
4. Pressure class	Class 150		Class 150		Class 2500	
5. Flange facing	Raised Face		Raised Face		Ring Type Joint	
6. Face finishing	125-250 µin. surface finish		125-250 µin. surface finish		Surface finish not exceed 63 µin.	
7. Coating	-		-		-	
8. Schedule (SCH) or thickness	-		-		-	
9. Size Range (NPS)	2" - 3"		2" - 40"		1" - 1 ½"	
10. Additional requirement	-		-		-	

Commodity Code	F-2500-R3		F-2500-RC		F-2500-RD	
Specs	H6		H10		H30P H30	
1. Flange type	Welding Neck Flange (WN)		Welding Neck Flange (WN)		Welding Neck Flange (WN)	
2. Material	ASTM A350 Gr LF2 Class 1		ASTM A694 Gr F65		ASTM A694 Gr F65 Cladded	
3. Standard	ASME B16.5		ASME B16.5		ASME B16.5	
4. Pressure class	Class 2500		Class 2500		Class 2500	
5. Flange facing	Ring Type Joint		Ring Type Joint		Ring Type Joint	
6. Face finishing	Surface finish not exceed 63 µin.		Surface finish not exceed 63 µin.		Surface finish not exceed 63 µin.	
7. Coating	-		-		Inconel (UNS N06625) clad	
8. Schedule (SCH) or thickness	-		-		-	
9. Size Range (NPS)	1" - 12"		2" - 12"		4" - 12"	
10. Additional requirement	-		-		-	

Commodity Code	F-2500-RG		F-2500-RH		F-2500-RL	
Specs	H16		H12P H12		H30P H30	
1. Flange type	Welding Neck Flange (WN)		Welding Neck Flange (WN)		Welding Neck Flange (WN)	
2. Material	ASTM A182 Gr F51		ASTM A182 Gr F55		ASTM B564 (UNS N06625)	
3. Standard	ASME B16.5		ASME B16.5		ASME B16.5	
4. Pressure class	Class 2500		Class 2500		Class 2500	
5. Flange facing	Ring Type Joint		Ring Type Joint		Ring Type Joint	
6. Face finishing	Surface finish not exceed 63 µin.		Surface finish not exceed 63 µin.		Surface finish not exceed 63 µin.	
7. Coating	-		-		-	
8. Schedule (SCH) or thickness	-		-		-	
9. Size Range (NPS)	1" - 12"		1" - 12"		1" - 3"	
10. Additional requirement	-		-		-	

Commodity Code	F-2500-RX		F-300-K2		F-300-K3	
Specs	H3		C4 C8 C9 C10 C11		C6 C19	
1. Flange type	Welding Neck Flange (WN)		Welding Neck Flange (WN)		Welding Neck Flange (WN)	
2. Material	ASTM A182 Gr F316/316L		ASTM A105		ASTM A350 Gr LF2 Class 1	
3. Standard	ASME B16.5		½" - 24"	ASME B16.5	2" - 24"	ASME B16.5
	-		26" - 32"	ASME B16.47 Series A	26" - 30"	ASME B16.47 Series A
4. Pressure class	Class 2500		Class 300		Class 300	
5. Flange facing	Ring Type Joint		Raised Face		Raised Face	
6. Face finishing	Surface finish not exceed 63 µin.		125-250 µin. surface finish		125-250 µin. surface finish	
7. Coating	-		-		-	
8. Schedule (SCH) or thickness	-		-		-	
9. Size Range (NPS)	1" - 12"		½" - 32"		2" - 30"	
10. Additional requirement	-		-		-	

Commodity Code	F-300-KB		F-300-KG		F-300-KH	
Specs	C30		C16		C12	
1. Flange type	Welding Neck Flange (WN)		Welding Neck Flange (WN)		Welding Neck Flange (WN)	
2. Material	ASTM A105 Cladded		ASTM A182 Gr F51		ASTM A182 Gr F55	
3. Standard	4" - 24"	ASME B16.5	ASME B16.5		2" - 24"	ASME B16.5
	26"	ASME B16.47 Series A	-		26" - 30"	ASME B16.47 Series A
4. Pressure class	Class 300		Class 300		Class 300	
5. Flange facing	Raised Face		Raised Face		Raised Face	
6. Face finishing	125-250 µin. surface finish		125-250 µin. surface finish		125-250 µin. surface finish	
7. Coating	Inconel (UNS N06625) clad		-		-	
8. Schedule (SCH) or thickness	-		-		-	
9. Size Range (NPS)	4" - 26"		2" - 24"		2" - 30"	
10. Additional requirement	-		-		-	

Commodity Code	F-300-KL		F-300-KW		F-300-KX	
Specs	C30		B50		C3	
1. Flange type	Welding Neck Flange (WN)		Welding Neck Flange (WN)		Welding Neck Flange (WN)	
2. Material	ASTM B564 (UNS N06625)		ASTM A182 Gr F310H		ASTM A182 Gr F316/316L	
3. Standard	ASME B16.5		2" - 24"	ASME B16.5	2" - 24"	ASME B16.5
	-		26" - 56"	ASME B16.47 Series A	26" - 30"	ASME B16.47 Series A
4. Pressure class	Class 300		Class 300		Class 300	
5. Flange facing	Raised Face		Raised Face		Raised Face	
6. Face finishing	125-250 µin. surface finish		125-250 µin. surface finish		125-250 µin. surface finish	
7. Coating	-		-		-	
8. Schedule (SCH) or thickness	-		-		-	
9. Size Range (NPS)	2" - 3"		2" - 56"		2" - 30"	
10. Additional requirement	-		-		-	

Commodity Code	F-300-RW		F-600-K2		F-600-K3	
Specs			E8		E6 E19	
1. Flange type	Welding Neck Flange (WN)		Welding Neck Flange (WN)		Welding Neck Flange (WN)	
2. Material	ASTM A182 Gr F310H		ASTM A105		ASTM A350 Gr LF2 Class 1	
3. Standard	2" - 24"	ASME B16.5	ASME B16.5		ASME B16.5	
	26" - 36"	ASME B16.47 Series A	-		-	
4. Pressure class	Class 300		Class 600		Class 600	
5. Flange facing	Ring Type Joint		Raised Face		Raised Face	
6. Face finishing	Surface finish not exceed 63 µin.		125-250 µin. surface finish		125-250 µin. surface finish	
7. Coating	-		-		-	
8. Schedule (SCH) or thickness	-		-		-	
9. Size Range (NPS)	2" - 36"		½" - 24"		2" - 24"	
10. Additional requirement	-		-		-	

Commodity Code	F-600-KC		F-600-KE		F-600-KG	
Specs	E9 E10 E30		E32		E16	
1. Flange type	Welding Neck Flange (WN)		Welding Neck Flange (WN)		Welding Neck Flange (WN)	
2. Material	ASTM A694 Gr F65		ASTM A350 Gr LF3 Cladded		ASTM A182 Gr F51	
3. Standard	ASME B16.5		ASME B16.5		ASME B16.5	
4. Pressure class	Class 600		Class 600		Class 600	
5. Flange facing	Raised Face		Raised Face		Raised Face	
6. Face finishing	125-250 µin. surface finish		125-250 µin. surface finish		125-250 µin. surface finish	
7. Coating	-		Inconel (UNS N06625) clad		-	
8. Schedule (SCH) or thickness	-		-		-	
9. Size Range (NPS)	2" - 24"		4" - 16"		2" - 16"	
10. Additional requirement	-		-		-	

Commodity Code	F-600-KL		F-600-KX		F-600-R3	
Specs	E30 E32		E3			
1. Flange type	Welding Neck Flange (WN)		Welding Neck Flange (WN)		Welding Neck Flange (WN)	
2. Material	ASTM B564 (UNS N06625)		ASTM A182 Gr F316/316L		ASTM A350 Gr LF2 Class 1	
3. Standard	ASME B16.5		ASME B16.5		-	
4. Pressure class	Class 600		Class 600		Class 600	
5. Flange facing	Raised Face		Raised Face		Ring Type Joint	
6. Face finishing	125-250 µin. surface finish		125-250 µin. surface finish		Surface finish not exceed 63 µin.	
7. Coating	-		-		-	
8. Schedule (SCH) or thickness	-		-		-	
9. Size Range (NPS)	2" - 3"		2" - 24"		-	
10. Additional requirement	-		-		-	

Commodity Code	F-600-R7	F-600-RB	F-600-RC
Specs			
1. Flange type	Welding Neck Flange (WN)	Welding Neck Flange (WN)	Welding Neck Flange (WN)
2. Material	ASTM A182 Gr F316L	ASTM A105 Cladded	ASTM A694 Gr F65
3. Standard	-	-	-
4. Pressure class	Class 600	Class 600	Class 600
5. Flange facing	Ring Type Joint	Ring Type Joint	Ring Type Joint
6. Face finishing	Surface finish not exceed 63 µin.	Surface finish not exceed 63 µin.	Surface finish not exceed 63 µin.
7. Coating	-	Inconel (UNS N06625) clad	-
8. Schedule (SCH) or thickness	-	-	-
9. Size Range (NPS)	-	-	-
10. Additional requirement	-	-	-

Commodity Code	F-600-RE	F-600-RG	F-600-RL
Specs			
1. Flange type	Welding Neck Flange (WN)	Welding Neck Flange (WN)	Welding Neck Flange (WN)
2. Material	ASTM A350 Gr LF3 Cladded	ASTM A182 Gr F51	ASTM B564 (UNS N06625)
3. Standard	-	-	-
4. Pressure class	Class 600	Class 600	Class 600
5. Flange facing	Ring Type Joint	Ring Type Joint	Ring Type Joint
6. Face finishing	Surface finish not exceed 63 µin.	Surface finish not exceed 63 µin.	Surface finish not exceed 63 µin.
7. Coating	Inconel (UNS N06625) clad	-	-
8. Schedule (SCH) or thickness	-	-	-
9. Size Range (NPS)	-	-	-
10. Additional requirement	-	-	-

Commodity Code	F-900-R3	F-900-RB	F-900-RC
Specs	F6		F10
1. Flange type	Welding Neck Flange (WN)	Welding Neck Flange (WN)	Welding Neck Flange (WN)
2. Material	ASTM A350 Gr LF2 Class 1	ASTM A105 Cladded	ASTM A694 Gr F65
3. Standard	ASME B16.5	ASME B16.5	3" - 24" ASME B16.5 26" - 34" ASME B16.47 Series A
4. Pressure class	Class 900	Class 900	Class 900
5. Flange facing	Ring Type Joint	Ring Type Joint	Ring Type Joint
6. Face finishing	Surface finish not exceed 63 µin.	Surface finish not exceed 63 µin.	Surface finish not exceed 63 µin.
7. Coating	-	Inconel (UNS N06625) clad	-
8. Schedule (SCH) or thickness	-	-	-
9. Size Range (NPS)	3" - 20"	4" - 24"	3" - 34"
10. Additional requirement	-	-	-

Commodity Code	F-900-RX
Specs	F3
1. Flange type	Welding Neck Flange (WN)
2. Material	ASTM A182 Gr F316/316L
3. Standard	ASME B16.5
4. Pressure class	Class 900
5. Flange facing	Ring Type Joint
6. Face finishing	Surface finish not exceed 63 µin.
7. Coating	-
8. Schedule (SCH) or thickness	-
9. Size Range (NPS)	3" - 18"
10. Additional requirement	-

B12.4.7 FLANGE WITH MAF TYPE I - PRESS TYPE END

Commodity Code	F-150-Z2	F-150-ZF	F-20-ZN
Specs	S9B	S3B	S7
1. Flange type	Flange with MAF Type I - Press Type End	Flange with MAF Type I - Press Type End	Flange with MAF Type I - Press Type End
2. Material	ASTM A105	ASTM A182 Gr F316	Cu-Ni 70/30
3. Standard	ASTM F1387	ASTM F1387	ASTM F1387
4. Pressure class	Class 150	Class 150	20 bar
5. Flange facing	Raised Face	Raised Face	Raised Face
6. Face finishing	125-250 µin. surface finish	125-250 µin. surface finish	125-250 µin. surface finish
7. Coating	-	-	-
8. Schedule (SCH) or thickness	-	-	-
9. Size Range (NPS)	½" - 2"	½" - 2"	½" - 2"
10. Additional requirement	-	-	-

Commodity Code	F-300-Z2	F-300-ZF
Specs	S9C	S3C
1. Flange type	Flange with MAF Type I - Press Type End	Flange with MAF Type I - Press Type End
2. Material	ASTM A105	ASTM A182 Gr F316
3. Standard	ASTM F1387	ASTM F1387
4. Pressure class	Class 300	Class 300
5. Flange facing	Raised Face	Raised Face
6. Face finishing	125-250 µin. surface finish	125-250 µin. surface finish
7. Coating	-	-
8. Schedule (SCH) or thickness	-	-
9. Size Range (NPS)	½" - 2"	½" - 2"
10. Additional requirement	-	-

B12.4.8 BACKING FLANGE

Commodity Code	F-16-YV	F-20-Y2	F-25-YV
Specs	B23 B26	B7R B7	C23
1. Flange type	Backing Flange	Backing Flange	Backing Flange
2. Material	ASTM A105 Epoxy coated	ASTM A105	ASTM A105 Epoxy coated
3. Standard	Drilling acc. B16.5/B16.47 CL150	EEMUA 234	Drilling acc. B16.5/B16.47 CL300
4. Pressure class	16 bar	20 bar	25 bar
5. Flange facing	Raised Face	Raised Face	Raised Face
6. Face finishing	-	-	-
7. Coating	Epoxy coated	Epoxy coated	Epoxy coated
8. Schedule (SCH) or thickness	-	-	-
9. Size Range (NPS)	1" - 44"	2" - 36"	1" - 28"
10. Additional requirement	-	-	-

B12.4.9 SLIP ON FLANGE (SO)

Commodity Code	F-20-HM
Specs	B7R B7
1. Flange type	Slip On Flange (SO)
2. Material	Cu-Ni 90/10 (UNS 70620)
3. Standard	EEMUA 234
4. Pressure class	20 bar
5. Flange facing	Raised Face
6. Face finishing	125-250 µin. surface finish
7. Coating	-
8. Schedule (SCH) or thickness	-
9. Size Range (NPS)	½" - 1 ½"
10. Additional requirement	-

B12.4.10 WELDING NECK COMPACT FLANGE

Commodity Code	F-2500-U3	F-2500-UC	F-2500-UD
Specs	H6	H10	H30P H30
1. Flange type	Welding Neck Compact Flange	Welding Neck Compact Flange	Welding Neck Compact Flange
2. Material	ASTM A350 Gr LF2 Class 1	ASTM A694 Gr F65	ASTM A694 Gr F65 Cladded
3. Standard	ISO 27509	ISO 27509	ISO 27509
4. Pressure class	Class 2500	Class 2500	Class 2500
5. Flange facing	IX seal ring	IX seal ring	IX seal ring
6. Face finishing	Surface finish accordig to ISO 4287	Surface finish accordig to ISO 4287	Surface finish accordig to ISO 4287
7. Coating	-	-	Inconel (UNS N06625) clad
8. Schedule (SCH) or thickness	-	-	-
9. Size Range (NPS)	1" - 18"	1" - 20"	4" - 24"
10. Additional requirement	-	-	-

Commodity Code	F-2500-UG	F-2500-UH	F-2500-UL
Specs	H16	H12P H12	H30P H30
1. Flange type	Welding Neck Compact Flange	Welding Neck Compact Flange	Welding Neck Compact Flange
2. Material	ASTM A182 Gr F51	ASTM A182 Gr F55	ASTM B564 (UNS N06625)
3. Standard	ISO 27509	ISO 27509	ISO 27509
4. Pressure class	Class 2500	Class 2500	Class 2500
5. Flange facing	IX seal ring	IX seal ring	IX seal ring
6. Face finishing	Surface finish accordig to ISO 4287	Surface finish accordig to ISO 4287	Surface finish accordig to ISO 4287
7. Coating	-	-	-
8. Schedule (SCH) or thickness	-	-	-
9. Size Range (NPS)	1" - 24"	1" - 24"	1" - 3"
10. Additional requirement	-	-	-

Commodity Code	F-2500-UX
Specs	H3
1. Flange type	Welding Neck Compact Flange
2. Material	ASTM A182 Gr F316/316L
3. Standard	ISO 27509
4. Pressure class	Class 2500
5. Flange facing	IX seal ring
6. Face finishing	Surface finish accordig to ISO 4287
7. Coating	-
8. Schedule (SCH) or thickness	-
9. Size Range (NPS)	1" - 16"
10. Additional requirement	-

B12.4.11 BLIND COMPACT FLANGE

Commodity Code	F-2500-V3	F-2500-VC	F-2500-VD
Specs	H6	H10	H30P H30
1. Flange type	Blind Compact Flange	Blind Compact Flange	Blind Compact Flange
2. Material	ASTM A350 Gr LF2 Class 1	ASTM A694 Gr F65	ASTM A694 Gr F65 Clad
3. Standard	ISO 27509	ISO 27509	ISO 27509
4. Pressure class	Class 2500	Class 2500	Class 2500
5. Flange facing	IX seal ring	IX seal ring	IX seal ring
6. Face finishing	Surface finish accordig to ISO 4287	Surface finish accordig to ISO 4287	Surface finish accordig to ISO 4287
7. Coating	-	-	Inconel (UNS N06625) clad
8. Schedule (SCH) or thickness	-	-	-
9. Size Range (NPS)	1" - 18"	1" - 20"	4" - 24"
10. Additional requirement	-	-	-

Commodity Code	F-2500-VG	F-2500-VH	F-2500-VL
Specs	H16	H12P H12	H30P H30
1. Flange type	Blind Compact Flange	Blind Compact Flange	Blind Compact Flange
2. Material	ASTM A182 Gr F51	ASTM A182 Gr F55	ASTM B564 (UNS N06625)
3. Standard	ISO 27509	ISO 27509	ISO 27509
4. Pressure class	Class 2500	Class 2500	Class 2500
5. Flange facing	IX seal ring	IX seal ring	IX seal ring
6. Face finishing	Surface finish accordig to ISO 4287	Surface finish accordig to ISO 4287	Surface finish accordig to ISO 4287
7. Coating	-	-	-
8. Schedule (SCH) or thickness	-	-	-
9. Size Range (NPS)	1" - 24"	1" - 24"	1" - 3"
10. Additional requirement	-	-	-

Commodity Code	F-2500-VX
Specs	H3
1. Flange type	Blind Compact Flange
2. Material	ASTM A182 Gr F316/316L
3. Standard	ISO 27509
4. Pressure class	Class 2500
5. Flange facing	IX seal ring
6. Face finishing	Surface finish accordig to ISO 4287
7. Coating	-
8. Schedule (SCH) or thickness	-
9. Size Range (NPS)	1" - 16"
10. Additional requirement	-

B12.4.12 HYDRAULIC ONE-PIECE FLANGE

Commodity Code	F-350-3X	F-420-3X
Specs	B3 C3 E3 F3 G3	H3
1. Flange type	Hydraulic One-Piece Flange	Hydraulic One-Piece Flange
2. Material	ASTM A182 Gr F316/316L	ASTM A182 Gr F316/316L
3. Standard	ISO 6162-1	ISO 6162-2
4. Pressure class	max 350 bar	max 420 bar
5. Flange facing	-	-
6. Face finishing	-	-
7. Coating	-	-
8. Schedule (SCH) or thickness	-	-
9. Size Range (NPS)	½" - 3"	1" - 3"
10. Additional requirement	-	-

5. GASKET

B12.5.1 RING-JOINT GASKET

Commodity Code	J-10000-AU	J-10000-AV	J-1500-AN
Specs	J12P J12	J40P J40	F10 G10P
1. Gasket type	BX Ring type	BX Ring type	Oval Type R Ring
2. Material	Duplex Stainless Steel, ASTM A182 F51	Inconel 625	Carbon Steel
3. Gasket standard	API 6A	API 6A	API 6A, ASME B16.20
4. Thickness	-	-	-
5. Hardness	maximum hardness 200 Brinell	maximum hardness 92 Rockwell B	maximum hardness 90 Brinell
6. Flange Type	API 10000, Ring Type Joint	API 10000, Ring Type Joint	Class 1500, Ring Type Joint
7. Size Range (NPS)	1" - 16"	1" - 14"	½" - 24"
8. Additional requirements	-	-	-

Commodity Code	J-1500-AT	J-2500-AN	J-2500-AT
Specs	F3 F6 G3	H10	H3 H6
1. Gasket type	Oval Type R Ring	Oval Type R Ring	Oval Type R Ring
2. Material	SS AISI 316	Carbon Steel	SS AISI 316
3. Gasket standard	API 6A, ASME B16.20	API 6A, ASME B16.20	API 6A, ASME B16.20
4. Thickness	-	-	-
5. Hardness	maximum hardness 160 Brinell	maximum hardness 90 Brinell	maximum hardness 160 Brinell
6. Flange Type	Class 1500, Ring Type Joint	Class 2500, Ring Type Joint	Class 2500, Ring Type Joint
7. Size Range (NPS)	½" - 18"	1" - 12"	1" - 12"
8. Additional requirements	-	-	-

Commodity Code	J-2500-AU	J-2500-AV	J-2500-AW
Specs	H12P H12 H16	H30P H30	
1. Gasket type	Oval Type R Ring	Oval Type R Ring	Oval Type R Ring
2. Material	Duplex Stainless Steel, ASTM A182 F51	Inconel 625	ASTM A522 Type I
3. Gasket standard	API 6A, ASME B16.20	API 6A, ASME B16.20	API 6A, ASME B16.20
4. Thickness	-	-	-
5. Hardness	maximum hardness 200 Brinell	maximum hardness 230 Brinell	maximum hardness 210 Brinell
6. Flange Type	Class 2500, Ring Type Joint	Class 2500, Ring Type Joint	Class 2500, Ring Type Joint
7. Size Range (NPS)	1" - 12"	1" - 12"	1" - 12"
8. Additional requirements	-	-	-

Commodity Code	J-2500-BN	J-2500-BT	J-2500-BU
Specs	H10	H3 H6	H12P H12 H16
1. Gasket type	IX Ring type	IX Ring type	IX Ring type
2. Material	Carbon Steel	SS AISI 316	Duplex Stainless Steel, ASTM A182 F51
3. Gasket standard	ISO 27509	ISO 27509	ISO 27509
4. Thickness	-	-	-
5. Hardness	-	-	-
6. Flange Type	Class 2500, Metallic Seal Joint	Class 2500, Metallic Seal Joint	Class 2500, Metallic Seal Joint
7. Size Range (NPS)	1" - 20"	1" - 18"	1" - 24"
8. Additional requirements	-	-	-

Commodity Code	J-2500-BV	J-2500-BW	J-300-AT
Specs	H30P H30		
1. Gasket type	IX Ring type	IX Ring type	Oval Type R Ring
2. Material	Inconel 625	ASTM A522 Type I	SS AISI 316
3. Gasket standard	ISO 27509	ISO 27509	API 6A, ASME B16.20
4. Thickness	-	-	-
5. Hardness	-	-	maximum hardness 160 Brinell
6. Flange Type	Class 2500, Metallic Seal Joint	Class 2500, Metallic Seal Joint	Class 300, Ring Type Joint
7. Size Range (NPS)	1" - 24"	14" - 16"	½" - 48"
8. Additional requirements	-	-	-

Commodity Code	J-600-AT	J-600-AV	J-900-AN
Specs			F10
1. Gasket type	Oval Type R Ring	Oval Type R Ring	Oval Type R Ring
2. Material	SS AISI 316	Inconel 625	Carbon Steel
3. Gasket standard	API 6A, ASME B16.20	API 6A, ASME B16.20	API 6A, ASME B16.20
4. Thickness	-	-	-
5. Hardness	maximum hardness 160 Brinell	maximum hardness 230 Brinell	maximum hardness 90 Brinell
6. Flange Type	Class 600, Ring Type Joint	Class 600, Ring Type Joint	Class 900, Ring Type Joint
7. Size Range (NPS)	-	-	3" - 34"
8. Additional requirements	-	-	-

Commodity Code	J-900-AT
Specs	F3 F6
1. Gasket type	Oval Type R Ring
2. Material	SS AISI 316
3. Gasket standard	API 6A, ASME B16.20
4. Thickness	-
5. Hardness	maximum hardness 160 Brinell
6. Flange Type	Class 900, Ring Type Joint
7. Size Range (NPS)	3" - 20"
8. Additional requirements	-

B12.5.2 FLAT GASKET

Commodity Code	J-150-C3	J-150-CC	J-150-P3
Specs	B22	B14 B20 B21 B27	B23
1. Gasket type	Flat Gasket	Flat Gasket	Flat Gasket
2. Material	Neoprene rubber 60 Shore A	Multidirectional Expanded PTFE, PQR >= 0,5 (30MPa@150°C)	Neoprene rubber 60 Shore A
3. Gasket standard	ASME B16.21	ASME B16.21	ASME B16.21
4. Thickness	3 mm	3 mm	3 mm
5. Flange Type	1" - 24" ASME B16.5, Class 150, Flat Face 26" - 44" ASME B16.47 A, Class 150, Flat Face	½" - 24" ASME B16.5, Class 150, Flat Face 26" - 48" ASME B16.47 A, Class 150, Flat Face	1" - 24" ASME B16.5, Class 150, Raised Face 26" - 46" ASME B16.47 A, Class 150, Raised Face
6. Size Range (NPS)	1" - 44"	½" - 48"	1" - 46"

Commodity Code	J-150-P4	J-150-PA	J-150-PC
Specs	B7R B7	S7	B11 B26
1. Gasket type	Flat Gasket	Flat Gasket	Flat Gasket
2. Material	Fibers bound with NBR compressed sheet, with Fire test certificate	Aramid fiber with NBR rubber	Multidirectional Expanded PTFE, PQR >= 0,5 (30MPa@150°C)
3. Gasket standard	ASME B16.21	ASME B16.21	ASME B16.21
4. Thickness	½" - 10" 1,60 mm 12" - 36" 3,20 mm	½" - 10" 1,60 mm 12" - 36" 3,20 mm	3 mm -
5. Flange Type	½" - 24" ASME B16.5, Class 150, Raised Face 26" - 36" ASME B16.47 A, Class 150, Raised Face	½" - 24" ASME B16.5, Class 150, Raised Face 28" - 36" ASME B16.47 A, Class 150, Raised Face	½" - 24" ASME B16.5, Class 150, Raised Face 26" - 48" ASME B16.47 A, Class 150, Raised Face
6. Size Range (NPS)	½" - 36"	½" - 36"	½" - 48"

Commodity Code	J-300-P3	J-300-PA	J-300-PC
Specs	C23	C8	C11
1. Gasket type	Flat Gasket	Flat Gasket	Flat Gasket
2. Material	Neoprene rubber 60 Shore A	Aramid fiber with NBR rubber	Multidirectional Expanded PTFE, PQR >= 0,5 (30MPa@150°C)
3. Gasket standard	ASME B16.21	ASME B16.21	ASME B16.21
4. Thickness	3 mm -	½" - 10" 1,60 mm 12" - 48" 3,20 mm	3 mm -
5. Flange Type	1" - 24" ASME B16.5, Class 300, Raised Face 26" - 28" ASME B16.47 A, Class 300, Raised Face	½" - 24" ASME B16.5, Class 300, Raised Face 26" - 48" ASME B16.47 A, Class 300, Raised Face	½" - 24" ASME B16.5, Class 300, Raised Face 26" - 48" ASME B16.47 A, Class 300, Raised Face
6. Size Range (NPS)	1" - 28"	½" - 48"	½" - 48"

B12.5.3 ISOLATION GASKET KIT

Commodity Code	J-1500-HZ	J-150-DA	J-150-DY
Specs			
1. Gasket type	Isolation Gasket Kit	Isolation Gasket Kit	Isolation Gasket Kit
2. Gasket material (1 pc)	AISI 316 core with G-10 composite facing layers, and PTFE sealing ring.	Aramid fiber with NBR rubber	Phenolic gasket with Nitrile rubber facing layers
3. Bolt sleeves material (1 per bolt)	NEMA Grade G-10	NEMA Grade G-10	Mylar
4. Non metallic washers material (2 per bolt)	NEMA Grade G-10	NEMA Grade G-10	Phenolic
5. Metallic washers material (2 per bolt)	Hardened Carbon Steel, Zn-Ni coated	Hardened Carbon Steel, Zn-Ni coated	Hardened Carbon Steel, Zn-Ni coated
6. Gasket standard	-	-	-
7. Thickness	-	-	-
8. Temperature	150 °C	75 °C	75 °C
9. Flange Type	Class 1500	Class 150	Class 150
10. Size Range (NPS)	-	-	-
11. Additional requirements	-	-	-

Commodity Code	J-150-FA	J-150-FX	J-150-FY
Specs			
1. Gasket type	Isolation Gasket Kit	Isolation Gasket Kit	Isolation Gasket Kit
2. Gasket material (1 pc)	Aramid fiber with NBR rubber	AISI 316 grooved core with PTFE facing layers	Phenolic gasket with Nitrile rubber facing layers
3. Bolt sleeves material (1 per bolt)	NEMA Grade G-10	NEMA Grade G-10	Mylar
4. Non metallic washers material (2 per bolt)	NEMA Grade G-10	NEMA Grade G-10	Phenolic
5. Metallic washers material (2 per bolt)	Hardened Carbon Steel, Zn-Ni coated	Hardened Carbon Steel, Zn-Ni coated	Hardened Carbon Steel, Zn-Ni coated
6. Gasket standard	-	-	-
7. Thickness	-	-	-
8. Temperature	75 °C	150 °C	75 °C
9. Flange Type	Class 150	Class 150	Class 150
10. Size Range (NPS)	-	-	-
11. Additional requirements	-	-	-

Commodity Code	J-150-FZ	J-2500-HZ	J-300-FA
Specs			
1. Gasket type	Isolation Gasket Kit	Isolation Gasket Kit	Isolation Gasket Kit
2. Gasket material (1 pc)	AISI 316 core with G-10 composite facing layers, and PTFE sealing ring.	AISI 316 core with G-10 composite facing layers, and PTFE sealing ring.	Aramid fiber with NBR rubber
3. Bolt sleeves material (1 per bolt)	NEMA Grade G-10	NEMA Grade G-10	NEMA Grade G-10
4. Non metallic washers material (2 per bolt)	NEMA Grade G-10	NEMA Grade G-10	NEMA Grade G-10
5. Metallic washers material (2 per bolt)	Hardened Carbon Steel, Zn-Ni coated	Hardened Carbon Steel, Zn-Ni coated	Hardened Carbon Steel, Zn-Ni coated
6. Gasket standard	-	-	-
7. Thickness	-	-	-
8. Temperature	150 °C	150 °C	75 °C
9. Flange Type	Class 150	Class 2500	Class 300
10. Size Range (NPS)	-	-	-
11. Additional requirements	-	-	-

Commodity Code	J-300-FX	J-300-FY	J-600-FX
Specs			
1. Gasket type	Isolation Gasket Kit	Isolation Gasket Kit	Isolation Gasket Kit
2. Gasket material (1 pc)	AISI 316 grooved core with PTFE facing layers	Phenolic gasket with Nitrile rubber facing layers	AISI 316 grooved core with PTFE facing layers
3. Bolt sleeves material (1 per bolt)	NEMA Grade G-10	Mylar	NEMA Grade G-10
4. Non metallic washers material (2 per bolt)	NEMA Grade G-10	Phenolic	NEMA Grade G-10
5. Metallic washers material (2 per bolt)	Hardened Carbon Steel, Zn-Ni coated	Hardened Carbon Steel, Zn-Ni coated	Hardened Carbon Steel, Zn-Ni coated
6. Gasket standard	-	-	-
7. Thickness	-	-	-
8. Temperature	150 °C	75 °C	150 °C
9. Flange Type	Class 300	Class 300	Class 600
10. Size Range (NPS)	-	-	-
11. Additional requirements	-	-	-

Commodity Code	J-600-FZ	J-900-HZ
Specs		
1. Gasket type	Isolation Gasket Kit	Isolation Gasket Kit
2. Gasket material (1 pc)	AISI 316 core with G-10 composite facing layers, and PTFE sealing ring.	AISI 316 core with G-10 composite facing layers, and PTFE sealing ring.
3. Bolt sleeves material (1 per bolt)	NEMA Grade G-10	NEMA Grade G-10
4. Non metallic washers material (2 per bolt)	NEMA Grade G-10	NEMA Grade G-10
5. Metallic washers material (2 per bolt)	Hardened Carbon Steel, Zn-Ni coated	Hardened Carbon Steel, Zn-Ni coated
6. Gasket standard	-	-
7. Thickness	-	-
8. Temperature	150 °C	150 °C
9. Flange Type	Class 600	Class 900
10. Size Range (NPS)	-	-
11. Additional requirements	-	-

B12.5.4 SPIRAL-WOUND GASKET

Commodity Code	J-150-EH	J-150-EL	J-150-EM												
Specs	B3 B4 B6 B9 B10 B19 R3B R9B S3B S9B	B12 B16	B30												
1. Gasket type	Spiral-Wound Gasket	Spiral-Wound Gasket	Spiral-Wound Gasket												
2. Material	AISI 316 Stainless Steel windings with flexible graphite filler	Duplex SS (UNS S31803) windings with flexible graphite filler	Inconel 625 windings with flexible graphite filler												
3. Gasket standard	ASME B16.20	ASME B16.20	ASME B16.20												
4. Thickness	4,4 mm	4,4 mm	4,4 mm												
5. Centering and Inner rings	Centering and inner rings in AISI 316	Centering ring in AISI 316 and inner ring in Duplex Stainless Steel	Centering ring in AISI 316 and inner ring in Inconel 625												
6. Flange Type	<table border="1"> <tr> <td>½" - 24"</td> <td>ASME B16.5, Class 150, Raised Face</td> </tr> <tr> <td>26" - 40"</td> <td>ASME B16.47 A, Class 150, Raised Face</td> </tr> </table>	½" - 24"	ASME B16.5, Class 150, Raised Face	26" - 40"	ASME B16.47 A, Class 150, Raised Face	<table border="1"> <tr> <td>½" - 24"</td> <td>ASME B16.5, Class 150, Raised Face</td> </tr> <tr> <td>26" - 60"</td> <td>ASME B16.47 A, Class 150, Raised Face</td> </tr> </table>	½" - 24"	ASME B16.5, Class 150, Raised Face	26" - 60"	ASME B16.47 A, Class 150, Raised Face	<table border="1"> <tr> <td>½" - 24"</td> <td>ASME B16.5, Class 150, Raised Face</td> </tr> <tr> <td>26" - 30"</td> <td>ASME B16.47 A, Class 150, Raised Face</td> </tr> </table>	½" - 24"	ASME B16.5, Class 150, Raised Face	26" - 30"	ASME B16.47 A, Class 150, Raised Face
½" - 24"	ASME B16.5, Class 150, Raised Face														
26" - 40"	ASME B16.47 A, Class 150, Raised Face														
½" - 24"	ASME B16.5, Class 150, Raised Face														
26" - 60"	ASME B16.47 A, Class 150, Raised Face														
½" - 24"	ASME B16.5, Class 150, Raised Face														
26" - 30"	ASME B16.47 A, Class 150, Raised Face														
7. Size Range (NPS)	½" - 40"	½" - 60"	½" - 30"												
8. Additional requirements	-	-	-												

Commodity Code	J-300-E2	J-300-EH	J-300-EL												
Specs	B50	C3 C4 C6 C9 C10 C19 R3C R9C S3C S9C	C12 C16												
1. Gasket type	Spiral-Wound Gasket	Spiral-Wound Gasket	Spiral-Wound Gasket												
2. Material	AISI 316 Stainless Steel windings with mica based filler (high temperature)	AISI 316 Stainless Steel windings with flexible graphite filler	Duplex SS (UNS S31803) windings with flexible graphite filler												
3. Gasket standard	ASME B16.20	ASME B16.20	ASME B16.20												
4. Thickness	4,4 mm	4,4 mm	4,4 mm												
5. Centering and Inner rings	Centering and inner rings in AISI 316	Centering and inner rings in AISI 316	Centering ring in AISI 316 and inner ring in Duplex Stainless Steel												
6. Flange Type	<table border="1"> <tr> <td>½" - 24"</td> <td>ASME B16.5, Class 300, Raised Face</td> </tr> <tr> <td>26" - 56"</td> <td>ASME B16.47 A, Class 300, Raised Face</td> </tr> </table>	½" - 24"	ASME B16.5, Class 300, Raised Face	26" - 56"	ASME B16.47 A, Class 300, Raised Face	<table border="1"> <tr> <td>½" - 24"</td> <td>ASME B16.5, Class 300, Raised Face</td> </tr> <tr> <td>26" - 32"</td> <td>ASME B16.47 A, Class 300, Raised Face</td> </tr> </table>	½" - 24"	ASME B16.5, Class 300, Raised Face	26" - 32"	ASME B16.47 A, Class 300, Raised Face	<table border="1"> <tr> <td>½" - 24"</td> <td>ASME B16.5, Class 300, Raised Face</td> </tr> <tr> <td>26" - 60"</td> <td>ASME B16.47 A, Class 300, Raised Face</td> </tr> </table>	½" - 24"	ASME B16.5, Class 300, Raised Face	26" - 60"	ASME B16.47 A, Class 300, Raised Face
½" - 24"	ASME B16.5, Class 300, Raised Face														
26" - 56"	ASME B16.47 A, Class 300, Raised Face														
½" - 24"	ASME B16.5, Class 300, Raised Face														
26" - 32"	ASME B16.47 A, Class 300, Raised Face														
½" - 24"	ASME B16.5, Class 300, Raised Face														
26" - 60"	ASME B16.47 A, Class 300, Raised Face														
7. Size Range (NPS)	½" - 56"	½" - 32"	½" - 60"												
8. Additional requirements	-	-	-												

Commodity Code	J-300-EM	J-600-EH	J-600-EL								
Specs	C30	E3 E6 E8 E9 E10 E19	E16								
1. Gasket type	Spiral-Wound Gasket	Spiral-Wound Gasket	Spiral-Wound Gasket								
2. Material	Inconel 625 windings with flexible graphite filler	AISI 316 Stainless Steel windings with flexible graphite filler	Duplex SS (UNS S31803) windings with flexible graphite filler								
3. Gasket standard	ASME B16.20	ASME B16.20	ASME B16.20								
4. Thickness	4,4 mm	4,4 mm	4,4 mm								
5. Centering and Inner rings	Centering ring in AISI 316 and inner ring in Inconel 625	Centering and inner rings in AISI 316	Centering ring in AISI 316 and inner ring in Duplex Stainless Steel								
6. Flange Type	<table border="1"> <tr> <td>½" - 24"</td> <td>ASME B16.5, Class 300, Raised Face</td> </tr> <tr> <td>26"</td> <td>ASME B16.47 A, Class 300, Raised Face</td> </tr> </table>	½" - 24"	ASME B16.5, Class 300, Raised Face	26"	ASME B16.47 A, Class 300, Raised Face	ASME B16.5, Class 600, Raised Face	<table border="1"> <tr> <td>½" - 24"</td> <td>ASME B16.5, Class 600, Raised Face</td> </tr> <tr> <td>26" - 60"</td> <td>ASME B16.47 A, Class 600, Raised Face</td> </tr> </table>	½" - 24"	ASME B16.5, Class 600, Raised Face	26" - 60"	ASME B16.47 A, Class 600, Raised Face
½" - 24"	ASME B16.5, Class 300, Raised Face										
26"	ASME B16.47 A, Class 300, Raised Face										
½" - 24"	ASME B16.5, Class 600, Raised Face										
26" - 60"	ASME B16.47 A, Class 600, Raised Face										
7. Size Range (NPS)	½" - 26"	½" - 24"	½" - 60"								
8. Additional requirements	-	-	-								

Commodity Code	J-600-EM
Specs	E30 E32
1. Gasket type	Spiral-Wound Gasket
2. Material	Inconel 625 windings with flexible graphite filler
3. Gasket standard	ASME B16.20
4. Thickness	4,4 mm
5. Centering and Inner rings	Centering ring in AISI 316 and inner ring in Inconel 625
6. Flange Type	ASME B16.5, Class 600, Raised Face
7. Size Range (NPS)	½" - 20"
8. Additional requirements	-

B12.5.5 GROOVED METAL GASKET

Commodity Code	J-300-G1	
Specs		
1. Gasket type	Grooved metal Gasket	
2. Material	AISI 316 grooved core with Mica based covering layers (high temperature)	
3. Gasket standard	ASME B16.20	
4. Thickness	4,4 mm	
5. Centering and Inner rings	Centering ring in AISI 316	
6. Flange Type	2" - 24"	ASME B16.5, Class 300
	26" - 56"	ASME B16.47 A, Class 300
7. Size Range (NPS)	2" - 56"	
8. Additional requirements	-	

6. BOLTS & NUTS

STUD BOLT WITH 2 HEAVY HEXAGONAL NUTS

Commodity Code	P-10000-07		P-10000-09		P-1500-07	
Specs	J12P J12		J40P J40		G10P	
1. Item	Stud Bolt with 2 Heavy Hexagonal Nuts		Stud Bolt with 2 Heavy Hexagonal Nuts		Stud Bolt with 2 Heavy Hexagonal Nuts	
2. Bolt material	ASTM A193 Gr B7, Zn-Ni coated		ASTM A320 Gr L43, Zn-Ni coated		ASTM A193 Gr B7, Zn-Ni coated	
3. Nuts material	Hex heavy ASTM A194 Gr 2H, Zn-Ni coated		Hex heavy ASTM A194 Gr 7L, Zn-Ni coated		Hex heavy ASTM A194 Gr 2H, Zn-Ni coated	
4. Bolt thread type	½" - 1"	ASME B1.1, UNC 2A	½" - 1"	ASME B1.1, UNC 2A	½" - 1"	ASME B1.1, UNC 2A
	1 ⅜" - 3 ½"	ASME B1.1, UN 2A - 8 thd/in	1 ⅜" - 3 ½"	ASME B1.1, UN 2A - 8 thd/in	1 ⅜" - 3 ½"	ASME B1.1, UN 2A - 8 thd/in
5. Nut thread type	½" - 1"	ASME B1.1, UNC 2B	½" - 1"	ASME B1.1, UNC 2B	½" - 1"	ASME B1.1, UNC 2B
	1 ⅜" - 3 ½"	ASME B1.1, UN 2B - 8 thd/in	1 ⅜" - 3 ½"	ASME B1.1, UN 2B - 8 thd/in	1 ⅜" - 3 ½"	ASME B1.1, UN 2B - 8 thd/in
6. Coating	Zn-Ni ASTM B 841, Cl 1, B/E Type, Gr 5-8, heat treatment according ASTM B849/B850		Zn-Ni ASTM B 841, Cl 1, B/E Type, Gr 5-8, heat treatment according ASTM B849/B850		Zn-Ni ASTM B 841, Cl 1, B/E Type, Gr 5-8, heat treatment according ASTM B849/B850	
7. Size Range	½" - 3 ½"		½" - 3 ½"		½" - 3 ½"	
8. Additional requirements	-		-		-	

Commodity Code	P-1500-08		P-150-01		P-150-07	
Specs	G3		B4		B6 B7R B7 B9 B10 B11 B12 B14 B16 B19 B20 B21 B22 B23 B26 B27 B30 R3B R9B S3B S7 S9B	
1. Item	Stud Bolt with 2 Heavy Hexagonal Nuts		Stud Bolt with 2 Heavy Hexagonal Nuts		Stud Bolt with 2 Heavy Hexagonal Nuts	
2. Bolt material	ASTM A320 Gr L7, Zn-Ni coated		ASTM A193 Gr B7		ASTM A193 Gr B7, Zn-Ni coated	
3. Nuts material	Hex heavy ASTM A194 Gr 7L, Zn-Ni coated		HEX HEAVY ASTM A194 GR 2H		Hex heavy ASTM A194 Gr 2H, Zn-Ni coated	
4. Bolt thread type	½" - 1"	ASME B1.1, UNC 2A	½" - 1"	ASME B1.1, UNC 2A	½" - 1"	ASME B1.1, UNC 2A
	1 ⅜" - 3 ½"	ASME B1.1, UN 2A - 8 thd/in	1 ⅜" - 3 ½"	ASME B1.1, UN 2A - 8 thd/in	1 ⅜" - 3 ½"	ASME B1.1, UN 2A - 8 thd/in
5. Nut thread type	½" - 1"	ASME B1.1, UNC 2B	½" - 1"	ASME B1.1, UNC 2B	½" - 1"	ASME B1.1, UNC 2B
	1 ⅜" - 3 ½"	ASME B1.1, UN 2B - 8 thd/in	1 ⅜" - 3 ½"	ASME B1.1, UN 2B - 8 thd/in	1 ⅜" - 3 ½"	ASME B1.1, UN 2B - 8 thd/in
6. Coating	Zn-Ni ASTM B 841, Cl 1, B/E Type, Gr 5-8, heat treatment according ASTM B849/B850		-		Zn-Ni ASTM B 841, Cl 1, B/E Type, Gr 5-8, heat treatment according ASTM B849/B850	
7. Size Range	½" - 3 ½"		½" - 3 ½"		½" - 3 ½"	
8. Additional requirements	-		-		-	

Commodity Code	P-150-08		P-2500-11		P-2500-12	
Specs	B3		H3 H6 H12P H12 H16		H10 H30P H30	
1. Item	Stud Bolt with 2 Heavy Hexagonal Nuts		Stud Bolt with 2 Heavy Hexagonal Nuts		Stud Bolt with 2 Heavy Hexagonal Nuts	
2. Bolt material	ASTM A320 Gr L7, Zn-Ni coated		ASTM A320 Gr L7, Zn-Ni coated		ASTM A193 Gr B7, Zn-Ni coated	
3. Nuts material	Hex heavy ASTM A194 Gr 7L, Zn-Ni coated		Hex heavy ASTM A194 Gr 7L, Zn-Ni coated		Hex heavy ASTM A194 Gr 2H, Zn-Ni coated	
4. Bolt thread type	½" - 1"	ASME B1.1, UNC 2A	¾" - 1"	ASME B1.1, UNC 2A	¾" - 1"	ASME B1.1, UNC 2A
	1 ⅜" - 3 ½"	ASME B1.1, UN 2A - 8 thd/in	1 ⅜" - 3 ½"	ASME B1.1, UN 2A - 8 thd/in	1 ⅜" - 3 ½"	ASME B1.1, UN 2A - 8 thd/in
5. Nut thread type	½" - 1"	ASME B1.1, UNC 2B	¾" - 1"	ASME B1.1, UNC 2B	¾" - 1"	ASME B1.1, UNC 2B
	1 ⅜" - 3 ½"	ASME B1.1, UN 2B - 8 thd/in	1 ⅜" - 3 ½"	ASME B1.1, UN 2B - 8 thd/in	1 ⅜" - 3 ½"	ASME B1.1, UN 2B - 8 thd/in
6. Coating	Zn-Ni ASTM B 841, Cl 1, B/E Type, Gr 5-8, heat treatment according ASTM B849/B850		Zn-Ni ASTM B 841, Cl 1, B/E Type, Gr 5-8, heat treatment according ASTM B849/B850		Zn-Ni ASTM B 841, Cl 1, B/E Type, Gr 5-8, heat treatment according ASTM B849/B850	
7. Size Range	½" - 3 ½"		¾" - 3 ¼"		¾" - 3 ¼"	
8. Additional requirements	-		-		-	

Commodity Code	P-300-01		P-300-07		P-300-08	
Specs	C4		C6 C8 C9 C10 C11 C12 C16 C19 C23 C30 R3C R9C S3C S9C		C3	
1. Item	Stud Bolt with 2 Heavy Hexagonal Nuts		Stud Bolt with 2 Heavy Hexagonal Nuts		Stud Bolt with 2 Heavy Hexagonal Nuts	
2. Bolt material	ASTM A193 Gr B7		ASTM A193 Gr B7, Zn-Ni coated		ASTM A320 Gr L7, Zn-Ni coated	
3. Nuts material	HEX HEAVY ASTM A194 GR 2H		Hex heavy ASTM A194 Gr 2H, Zn-Ni coated		Hex heavy ASTM A194 Gr 7L, Zn-Ni coated	
4. Bolt thread type	½" - 1"	ASME B1.1, UNC 2A	½" - 1"	ASME B1.1, UNC 2A	½" - 1"	ASME B1.1, UNC 2A
	1 ⅛" - 3 ½"	ASME B1.1, UN 2A - 8 thd/in	1 ⅛" - 3 ½"	ASME B1.1, UN 2A - 8 thd/in	1 ⅛" - 3 ½"	ASME B1.1, UN 2A - 8 thd/in
5. Nut thread type	½" - 1"	ASME B1.1, UNC 2B	½" - 1"	ASME B1.1, UNC 2B	½" - 1"	ASME B1.1, UNC 2B
	1 ⅛" - 3 ½"	ASME B1.1, UN 2B - 8 thd/in	1 ⅛" - 3 ½"	ASME B1.1, UN 2B - 8 thd/in	1 ⅛" - 3 ½"	ASME B1.1, UN 2B - 8 thd/in
6. Coating	-		Zn-Ni ASTM B 841, Cl 1, B/E Type, Gr 5-8, heat treatment according ASTM B849/B850		Zn-Ni ASTM B 841, Cl 1, B/E Type, Gr 5-8, heat treatment according ASTM B849/B850	
7. Size Range	½" - 3 ½"		½" - 3 ½"		½" - 3 ½"	
8. Additional requirements	-		-		-	

Commodity Code	P-300-10		P-600-02		P-600-07	
Specs	B50		E32		E6 E8 E9 E10 E16 E19 E30	
1. Item	Stud Bolt with 2 Heavy Hexagonal Nuts		Stud Bolt with 2 Heavy Hexagonal Nuts		Stud Bolt with 2 Heavy Hexagonal Nuts	
2. Bolt material	ASTM A453 Gr 660		ASTM A320 GR L7		ASTM A193 Gr B7, Zn-Ni coated	
3. Nuts material	Hex heavy ASTM A453 Gr 660		HEX HEAVY ASTM A194 GR 7L		Hex heavy ASTM A194 Gr 2H, Zn-Ni coated	
4. Bolt thread type	½" - 1"	ASME B1.1, UNC 2A	½" - 1"	ASME B1.1, UNC 2A	½" - 1"	ASME B1.1, UNC 2A
	1 ⅛" - 2 ¼"	ASME B1.1, UN 2A - 8 thd/in	1 ⅛" - 3 ½"	ASME B1.1, UN 2A - 8 thd/in	1 ⅛" - 3 ½"	ASME B1.1, UN 2A - 8 thd/in
5. Nut thread type	½" - 1"	ASME B1.1, UNC 2B	½" - 1"	ASME B1.1, UNC 2B	½" - 1"	ASME B1.1, UNC 2B
	1 ⅛" - 2 ¼"	ASME B1.1, UN 2B - 8 thd/in	1 ⅛" - 3 ½"	ASME B1.1, UN 2B - 8 thd/in	1 ⅛" - 3 ½"	ASME B1.1, UN 2B - 8 thd/in
6. Coating	-		-		Zn-Ni ASTM B 841, Cl 1, B/E Type, Gr 5-8, heat treatment according ASTM B849/B850	
7. Size Range	½" - 2 ¼"		½" - 3 ½"		½" - 3 ½"	
8. Additional requirements	-		-		-	

Commodity Code	P-600-08		P-900-07		P-900-08	
Specs	E3		F6 F10		F3	
1. Item	Stud Bolt with 2 Heavy Hexagonal Nuts		Stud Bolt with 2 Heavy Hexagonal Nuts		Stud Bolt with 2 Heavy Hexagonal Nuts	
2. Bolt material	ASTM A320 Gr L7, Zn-Ni coated		ASTM A193 Gr B7, Zn-Ni coated		ASTM A320 Gr L7, Zn-Ni coated	
3. Nuts material	Hex heavy ASTM A194 Gr 7L, Zn-Ni coated		Hex heavy ASTM A194 Gr 2H, Zn-Ni coated		Hex heavy ASTM A194 Gr 7L, Zn-Ni coated	
4. Bolt thread type	½" - 1"	ASME B1.1, UNC 2A	½" - 1"	ASME B1.1, UNC 2A	½" - 1"	ASME B1.1, UNC 2A
	1 ⅛" - 3 ½"	ASME B1.1, UN 2A - 8 thd/in	1 ⅛" - 3 ½"	ASME B1.1, UN 2A - 8 thd/in	1 ⅛" - 3 ½"	ASME B1.1, UN 2A - 8 thd/in
5. Nut thread type	½" - 1"	ASME B1.1, UNC 2B	½" - 1"	ASME B1.1, UNC 2B	½" - 1"	ASME B1.1, UNC 2B
	1 ⅛" - 3 ½"	ASME B1.1, UN 2B - 8 thd/in	1 ⅛" - 3 ½"	ASME B1.1, UN 2B - 8 thd/in	1 ⅛" - 3 ½"	ASME B1.1, UN 2B - 8 thd/in
6. Coating	Zn-Ni ASTM B 841, Cl 1, B/E Type, Gr 5-8, heat treatment according ASTM B849/B850		Zn-Ni ASTM B 841, Cl 1, B/E Type, Gr 5-8, heat treatment according ASTM B849/B850		Zn-Ni ASTM B 841, Cl 1, B/E Type, Gr 5-8, heat treatment according ASTM B849/B850	
7. Size Range	½" - 3 ½"		½" - 3 ½"		½" - 3 ½"	
8. Additional requirements	-		-		-	

ANNEX C

TYPICAL ARRANGEMENT FOR DRAIN&VENT AND INSTRUMENTS (Mandatory)

INDEX

C.1.SCOPE	3
C.2.TYPICAL ARRANGEMENT FOR TEMPERATURE WELLS	3
C.3.TYPICAL ARRANGEMENT FOR DRAINS AND VENTS	5
C.4.TYPICAL ARRANGEMENT FOR PRESSURE INSTRUMENTS	9
C.5.TYPICAL ARRANGEMENT FOR ORIFICE FLANGE.....	10
C.6.TYPICAL ARRANGEMENT FOR FOR TUBING (SPEC T3)	10

C.1. SCOPE

This document stabilishes typical piping arrangements for installation of temperature wells, pressure instruments, orifice flanges, drains and vents. It's applicable for the Exploration and Production (E&P) business area, onshore and offshore, especially in oil and gas production and their process facilities.

C.2. TYPICAL ARRANGEMENT FOR TEMPERATURE WELLS

Table C.1- Typical arrangement for Temperature Wells (notes 3 and 4)

SPEC	Pipe Diameter	Type of Instalation					
		Curved			Vertical/Horizontal		
		¾" NPT Threaded	1 ½" Flanged	2" Flanged	¾" NPT Threaded	1 ½" Flanged	2" Flanged
CLASS 125	¾" to 1 ½"	Type 1A			Type 1C		
	2"	Type 1B					
	3" to 4"	Type 1E			Type 1D		
CLASS 150 up to 600 (note 1 and 2)	¾" to 1 ½"		Type 2A			Type 2D	
	2"		Type 2B				
	3" and above		Type 2C			Type 2E	
CLASS 900 up to 10000	¾" to 1 ½"			Type 2A			Type 2C
	2"			Type 2B			
	3" and above			Type 2E			Type 2D
Non-metallic piping	All		Not Applicable				

Notes:

- 1 – If pipe thickness for NPS 1 ½ is SCH XXS, it shall be used NPS 2 flanged connection.
- 2 – For piping specifications without NPS 1 ½, it shall be used NPS 2 flanged connection.
- 3 – The requirements of I-ET-3010.00-1200-800-P4X-013 - General Criteria for Instrumentation Projects shall be also attended.
- 4 – The flange diameters shown on Table C.1 are typical diameters, but it must be confirmed in detailed design phase with instrumentation team.

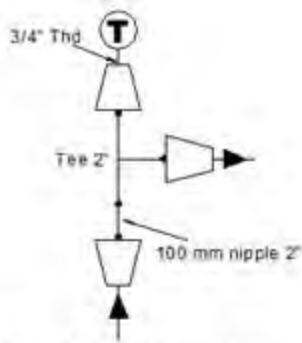

1A - Preferred arrangement
 NPS 3/4 up to 1 1/2

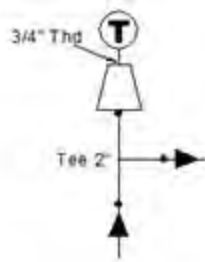

1B - Preferred arrangement
 NPS 2

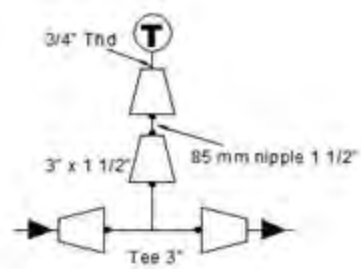

1C - Use only when 1A and
 1B are not possible

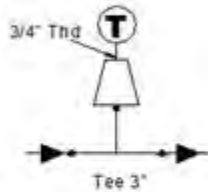

1D - Preferred arrangement
 NPS 3 and 4

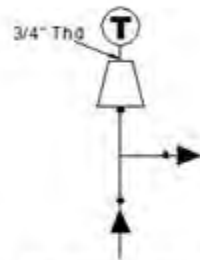

1E - Use only when 1D is
 not possible

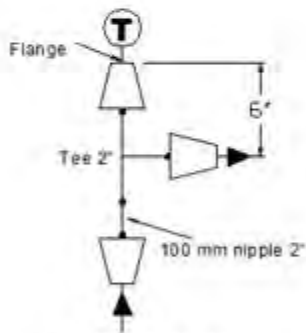

2A - Preferred arrangement
 NPS 3/4 up to 1 1/2
 (shall be in vertical position)

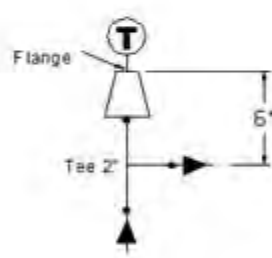

2B - Preferred arrangement
 NPS 2
 (shall be in vertical position)

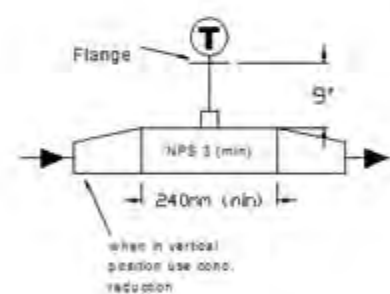

2C - Use only when 2A and
 2B are not possible

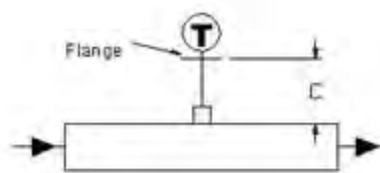

2D - Preferred arrangement
 NPS equal and greater than 3

C = 5" for NPS 3
 C = 6" for NPS equal and greater than 4

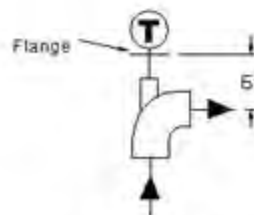

2E - Use only when 2D is
 not possible

C.3. TYPICAL ARRANGEMENT FOR DRAINS AND VENTS

C.3.1. Drain and vent size and pipe details shall be according to Table C.2.

Table C.2

Line size	Minimum Drain size (note 1)	Vent size (note 1)	Valve End (note 1 and 2)	
			CL 150 to CL 1500	CL 2500 and 10000 PSI
3/4 to 4	3/4	3/4	nipple with threaded cap (Figure C.1)	Flanged (Figure C.2)
6 to 10	1			
12 and above	1 1/2			

Note 1: For Group 5 specs, organic coated specs (Group 11 and 14), class 2500 and 10000psi specs: minimum pipe size for drains and vents shall be NPS 1. Vents maximum pipe size is also limited to NPS 1. Valves shall be flanged type selected according to the respectively piping spec (piping detail acc. Figure C.2).

Note 2: For CuNi specs (group 7) and galvanized carbon steel (group 8) specs, valves drain and vents shall be flanged type selected according to the respectively piping spec (piping detail acc. Figure C.2).

C.3.2. Valves of drain and vent used only for hydrostatic pressure test shall be removed and replaced by blind flanges after the test (Figure C.3). Valves codes for hydrostatic test are listed on below:

- Class 150# - VES-150-1-C100
- Class 300# - VES-300-1-C100
- Class 600# - VES-600-1-C100
- Class 900# - VES-900-1-C100
- Class 1500# - VES-1500-1-C100
- Class 2500# - VES-2500-1-C100

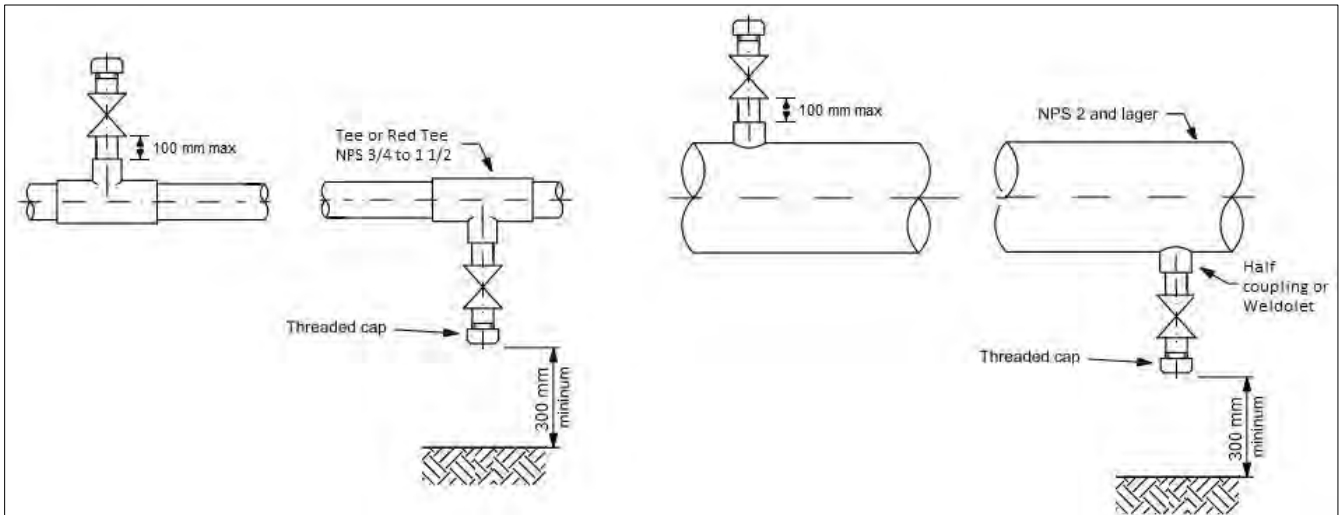

Figure C.1A - Drain&Vent single valve with threaded cap end for piping specs class 150, 300 and 600

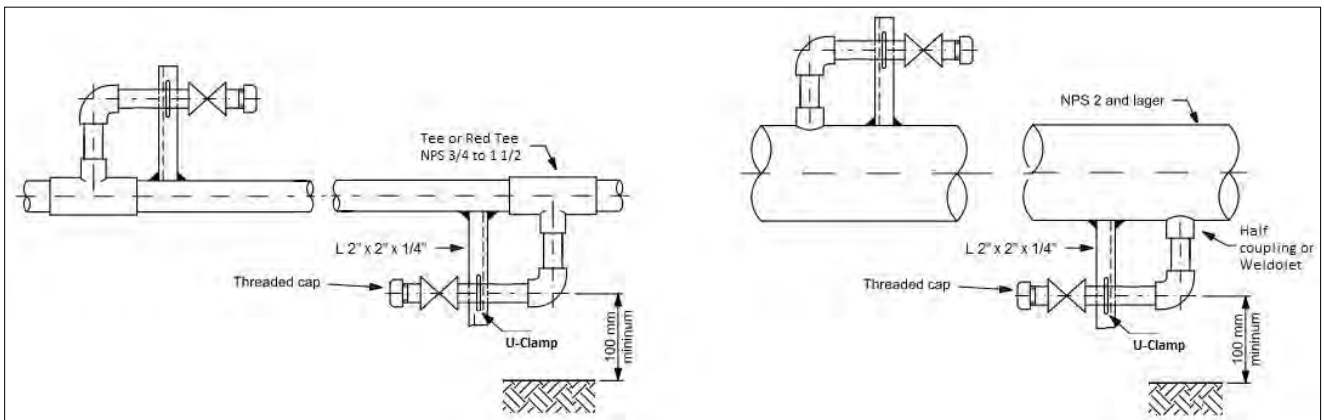

Figure C.1B - Drain&Vent single valve with threaded cap end for piping spec class 900 and 1500 (note 3).

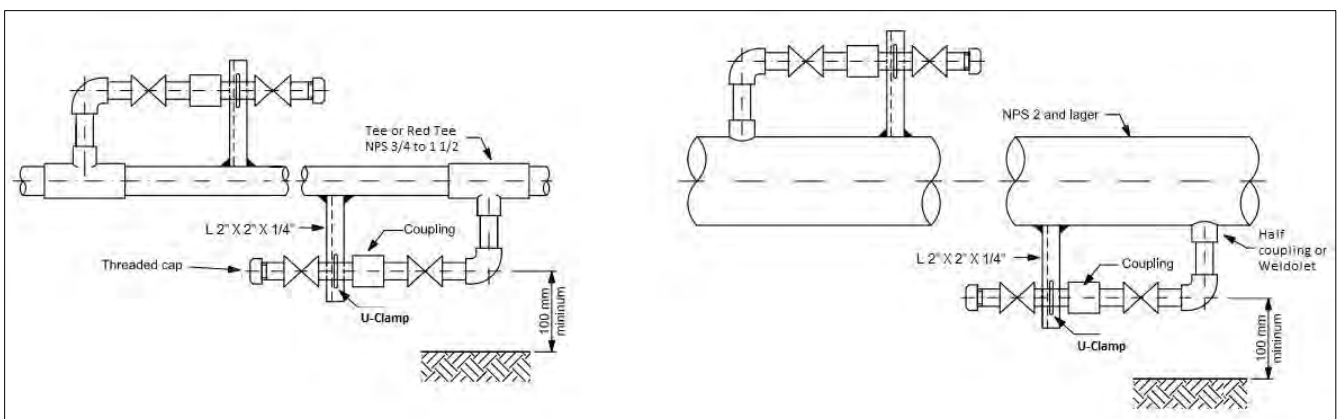

Figure C.1C - Drain&Vent two valves with threaded cap end

Notes:

- 1 – Valve type shall be selected in piping specification.
- 2 – See Figure C.3 for U-clamp details.
- 3 – Figure C.1B may be used as alternative to Figure C.1A

Figure C.1 – Drain&Vent pipe detail for class 150 to 1500

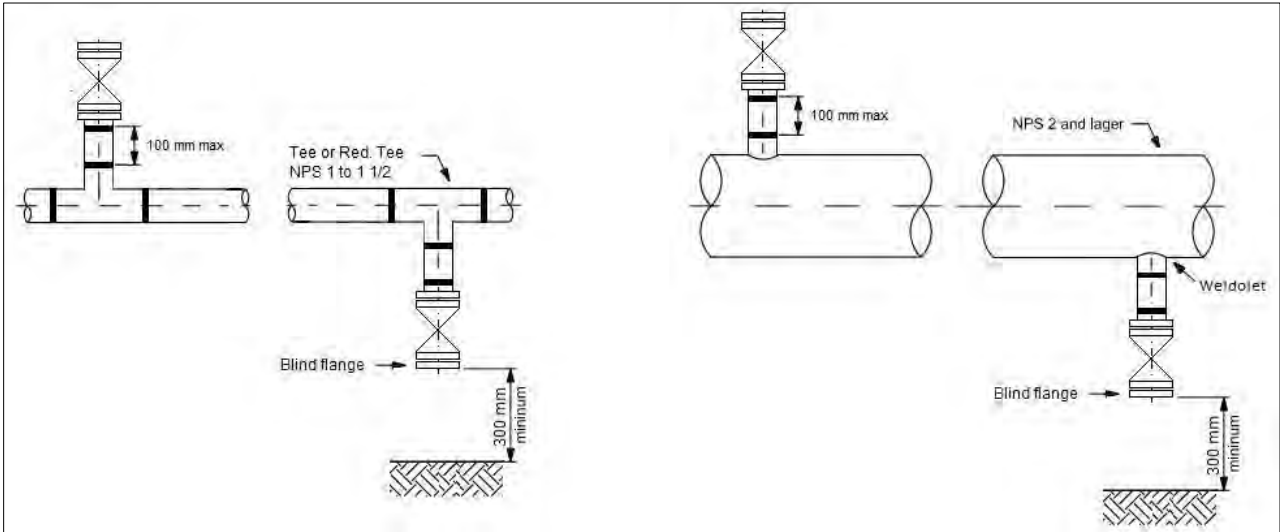

Figure C.2A - Drain & Vent single flanged valve with blind flange end for piping specs class 150, 300 and 600

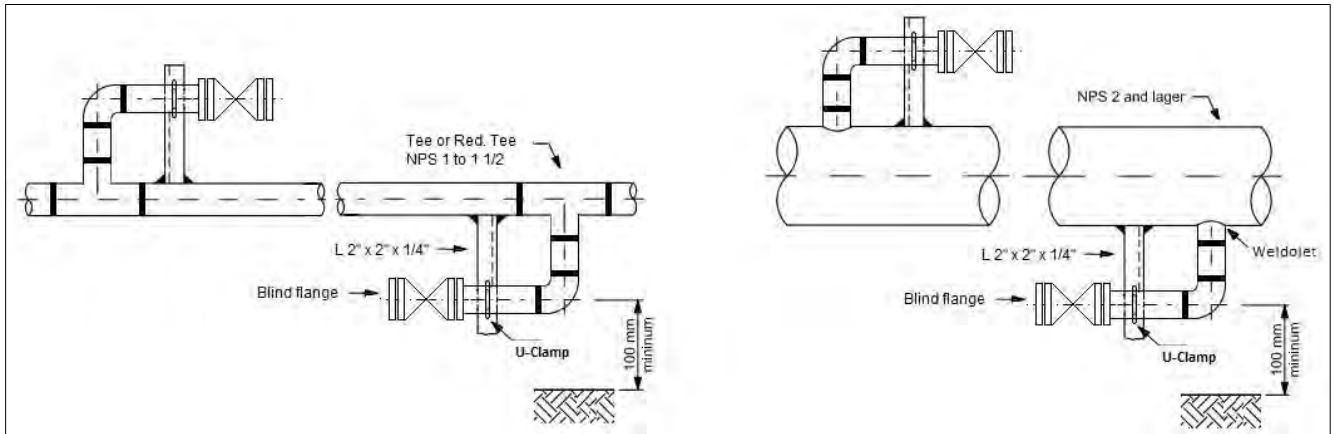

Figure C.2B - Drain & Vent single flanged valve with blind flange end for piping specs class 900 and higher. (note 3)

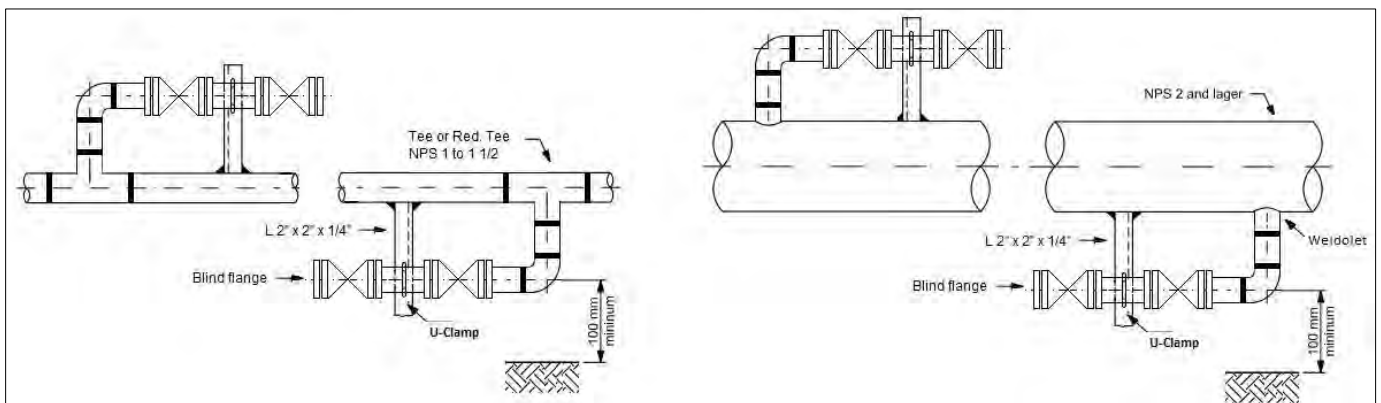

Figure C.2B - Drain & Vent two flanged valves with blind flange end

Notes:

- 1 – Valve type shall be selected in piping specification.
- 2 – See Figure C.4 for U-clamp details.
- 3 – Figure C.2B may be used as alternative to Figure C.2A

Figure C.2 – Drain & Vent pipe detail for class 2500 and 10000 psi

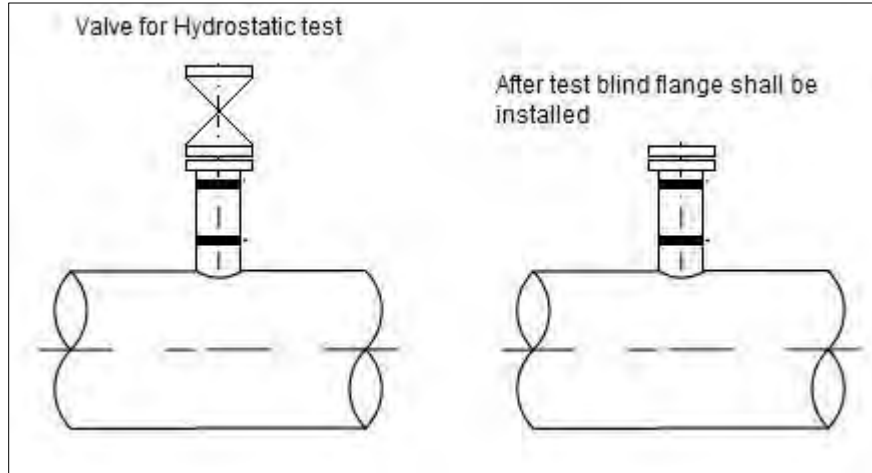
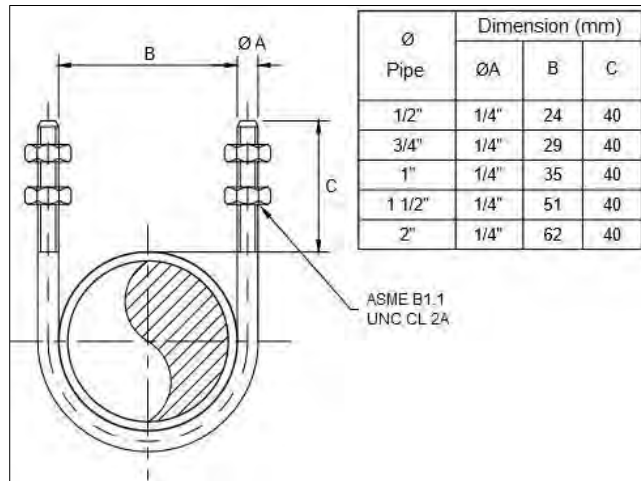

Figure C.3 – Drain&Vent for Hydrostatic Test



Notes:

1 – Material carbon steel coated with epoxy plastic powder.

Figure C.4 – U clamp details

C.4. TYPICAL ARRANGEMENT FOR PRESSURE INSTRUMENTS

C.4.1. Piping connection for pressure instruments shall be NPS 3/4, according Figure C.7, except for those listed in C.4.2.

C.4.2. For Group 5 specs, organic coated specs (Group 11 and Group 14), class 2500 and 10000psi specs: minimum pipe size for pressure instruments shall be NPS 1. Valves shall be flanged type selected according to the respectively piping spec. See Figure C.9.

C.4.3. The typical arrangement for A4, B7, B7R, C8 and E8 specs is shown in Figure C.8.

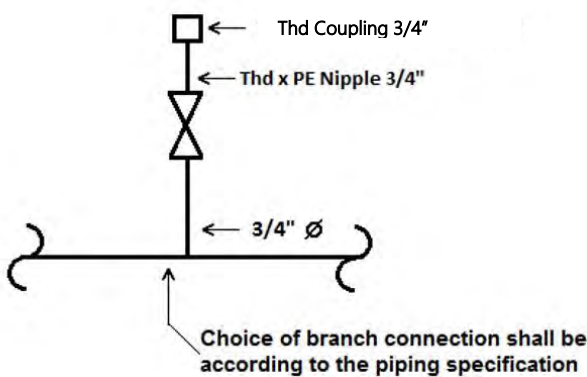

Figure C.5– Threaded Coupling end

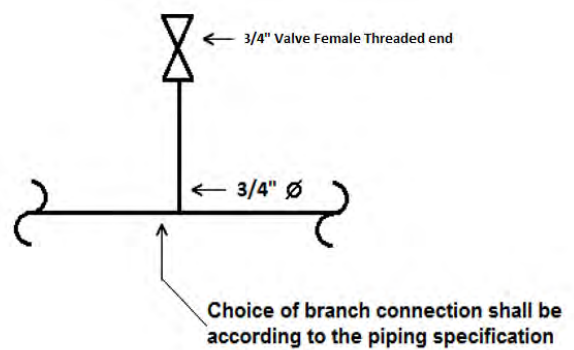

Figure C.6 – Threaded end valve

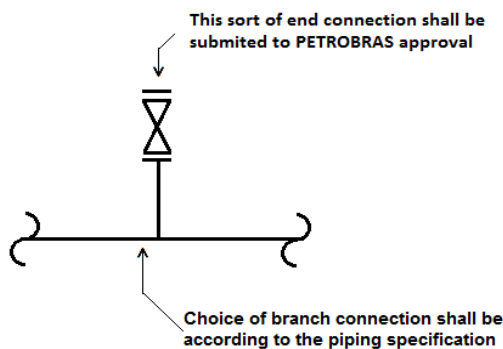

Figure C.7 – Flanged ending

C.5. TYPICAL ARRANGEMENT FOR ORIFICE FLANGE

- C.5.1. Orifice Flanges shall be according to ASME B16.36.
- C.5.2. All Valves used in orifice flanges shall be NPS 1/2, except for specs listed in Table C.4.
- C.5.3. For organic coated specs (Group 11 and 14) and FRP specs (B22, B23, B24, B26, and B27) use of orifice flanges is not permitted. In these lines, the flow tapes shall be installed with Stainless Steel AISI 316 spacer rings.
- C.5.4. The scope of piping discipline includes all components up to the valve (Figure C.8).

Table C.3- Connection diameter for orifice flanges

Valve NPS	Spec
3/4	B5 C5 E5 F5 G5 B17
1	B11 C11 E11 F11 G11 H11 B14 C14 E14 F14 G14 H14 E17 B22 B23 B24 B26 B27 H3 H6 H10 H10P H11 H30 H30P J5 J12 J31 J31PJ40
2	H5

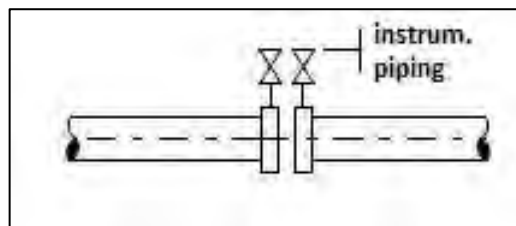

Figure C.8 – Scope definition

C.6. TYPICAL ARRANGEMENT FOR FOR TUBING (SPEC T3)

- C.6.1. Choice of branch shall be according to spec branch connections table.

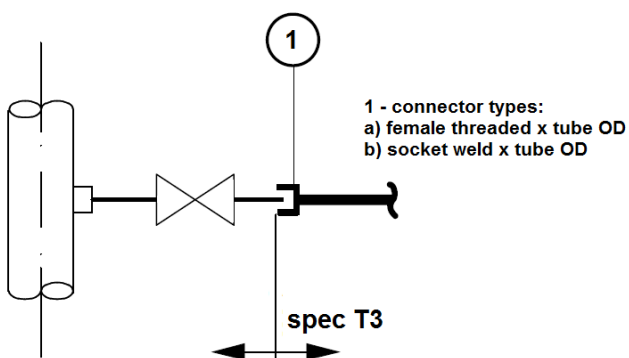

Figure C.9 – Instalation detail for valve with nipple

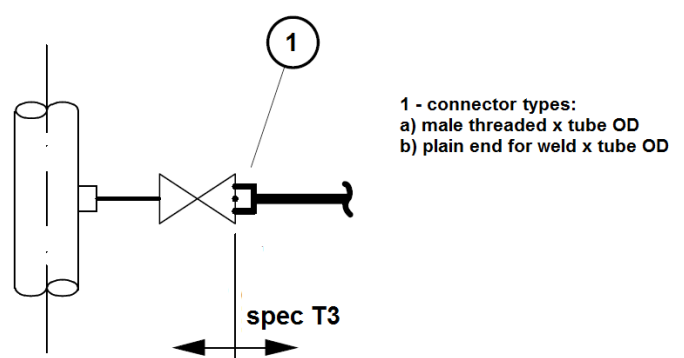

Figure C.10 - Instalation detail for valve without nipple

ANNEX D

PIPING MATERIAL SELECTION FOR CORROSIVE HYDROCARBONS AND PRODUCED WATER (Mandatory)

INDEX

D.1. SCOPE	3
D.2. NORMATIVE REFERENCES	3
D.3. GASEOUS HYDROCARBONS	3
D.3.1. WATER	3
D.3.2. CARBON DIOXIDE (CO ₂)	4
D.3.3. HYDROGEN SULFIDE GAS (H ₂ S)	5
D.3.4. GASEOUS HYDROCARBON FLOW DIAGRAM	7
D.4. MULTIPHASE HYDROCARBON	9
D.4.1. MULTIPHASE HYDROCARBON FLOW DIAGRAM	10
D.5. PRODUCED WATER	11
D.5.1. SELECTION OF PRODUCED WATER PIPING SPECIFICATION	11

D.1. SCOPE

The scope of this document is to define the piping material selection based on corrosivity of produced water and contaminants present in hydrocarbons flow, for use in Exploration and Production (E&P) business area, onshore and offshore, especially in oil and gas production and their process facilities.

D.2. NORMATIVE REFERENCES

Note: The Standards referred herein shall be considered in their latest edition/revision.

ISO 15156, *Petroleum and natural gas industries — Materials for use in H₂S -containing environments in oil and gas production*

NORSOK M506, *CO₂ corrosion rate calculation model Rev.2*

D.3. GASEOUS HYDROCARBONS

The degree of corrosiveness of the gaseous hydrocarbons is generally determined by the existence of the compounds:

- a) Water (H₂O)
- b) Carbon dioxide (CO₂)
- c) Hydrogen Sulfide Gas (H₂S)

D.3.1. WATER

The presence of humidity in the gas in sufficient quantities to cause condensation constitutes the source of an electric charge conducting medium (electrolyte) required for the corrosion reactions to occur.

Figure 1 denotes the maximum water content in the gas in terms of total temperature and pressure to prevent condensation.

Figure D.1: Effect of pressure and water content on the gas dew point.

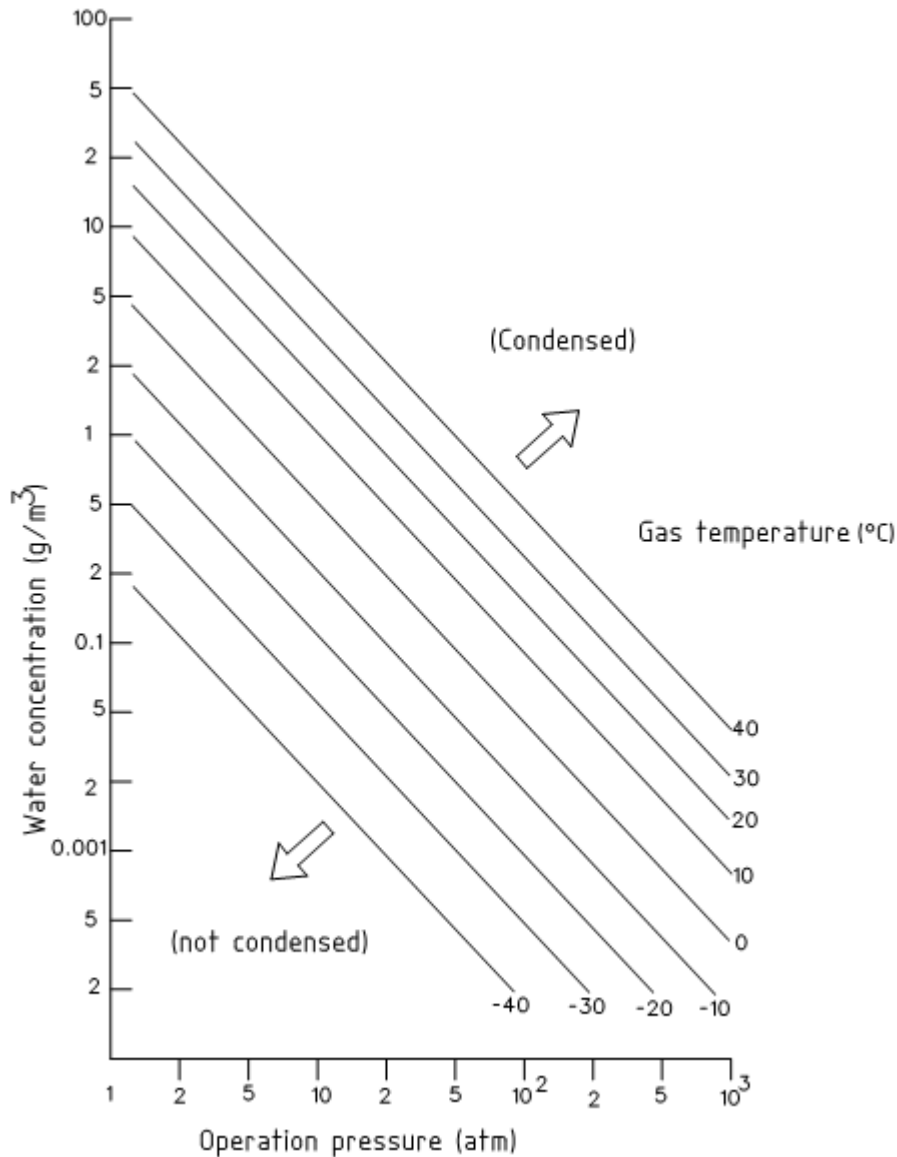

D.3.2. CARBON DIOXIDE (CO₂)

The carbon dioxide is only corrosive in the presence of free water, when it is dissolved, producing carbonic acid. The formation of carbonic acid (H₂CO₃) reduces the water's pH level, making it more corrosive and provides the formation of iron carbonate film. When this film is not adherent and protective, it generates localized corrosion, according to the following reactions:

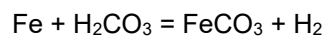
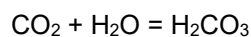

The main factors which influence the solubility of CO₂ are:

- a) Pressure
- b) Temperature
- c) Composition of the water (dissolved mineral salts)
- d) Organic Acids (manly acetic and formic acids)

The increase of the CO₂ solubility in water is directly proportional to the increase in pressure and inversely proportional to the increase in temperature.

The mineral salts in the water may prevent reduction of the pH level.

In reservoirs which produce natural gas, condensate and water containing low levels of mineral salts, pressure is the main factor for controlling the solubility of the CO₂. For this reason, the partial pressure of the CO₂ in the gaseous mixture is used to determine the degree of corrosiveness.

The partial pressure of a given gas in a mixture is the pressure which would be exerted in the event only the aforesaid gas was present, at the same temperature and total volume occupied by the mixture.

The partial pressure of each component is equal to the total pressure of the system multiplied by the molar fraction of the component (% in volume). In the case of the partial pressure of CO₂ (PCO₂) the expression is the following:

$$PCO_2 = \text{Total Pressure} \times \text{Molar Fraction of CO}_2 \text{ in the gas phase}$$

D.3.3. HYDROGEN SULFIDE GAS (H₂S)

The hydrogen sulfide gas is soluble in water, forming a weak acid, which causes corrosion and helps allows atomic hydrogen to penetrate the metals.

The general reaction for this kind of corrosion may be denoted by the formula:

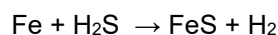
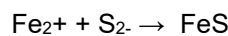
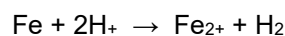
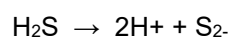

The ferrous sulfate produced under this reaction generally adheres to the surface of the steel in the form of a black powder or scaling. This FeS scaling acts as a cathode on the steel, resulting in pitting corrosion.

The most serious problem probably entails the penetration of the atomic hydrogen produced on the steel, where some of these hydrogen atoms react, forming hydrogen gas on the interfaces between the inclusions and the metal. Hydrogen gas accumulating in the defects to the crystalline structure, especially in the region surrounding the grains or

metal/inclusion interfaces, will produce high internal pressures, which could cause fractures or bubbles in the metal, provoking the stress corrosion cracking or reducing the fatigue life of the material.

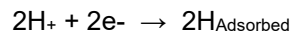

In the same way as the case of CO₂, the pressure is a factor of control of the solubility of H₂S in the medium in which this gas is dissolved. For this reason, the partial pressure of H₂S (pH₂S) in the gaseous mixture is also used to determine the corrosiveness level, associated or not to the partial pressure of CO₂.

$$P_{\text{H}_2\text{S}} = \text{Total Pressure} \times \text{Molar Fraction of H}_2\text{S in the gas phase}$$

The following relations are recommended to evaluate the corrosiveness of a gas, based on the H₂S content:

The gas is considered corrosive when the partial pressure of H₂S in the gas mixture is higher than 0.05 psia. This criteria is used to good effect by many gas distributing companies operating in the USA.

Another parameter for verification of the corrosiveness level with regard to the Sulfide Stress Cracking (SCC) is the use of the correlations showed in figures 2 and 3, which consider the partial pressures of H₂S and CO₂, the pH of the medium and hardness of the exposed material. For a good estimate of the pH, a software or a chemical model capable to calculate the pH based on the partial pressures of the gases and the chemical composition of the water can be used.

Figure D.2 – Calculation of the pH in function of the H₂S and CO₂ Partial Pressures, Temperature and bicarbonate

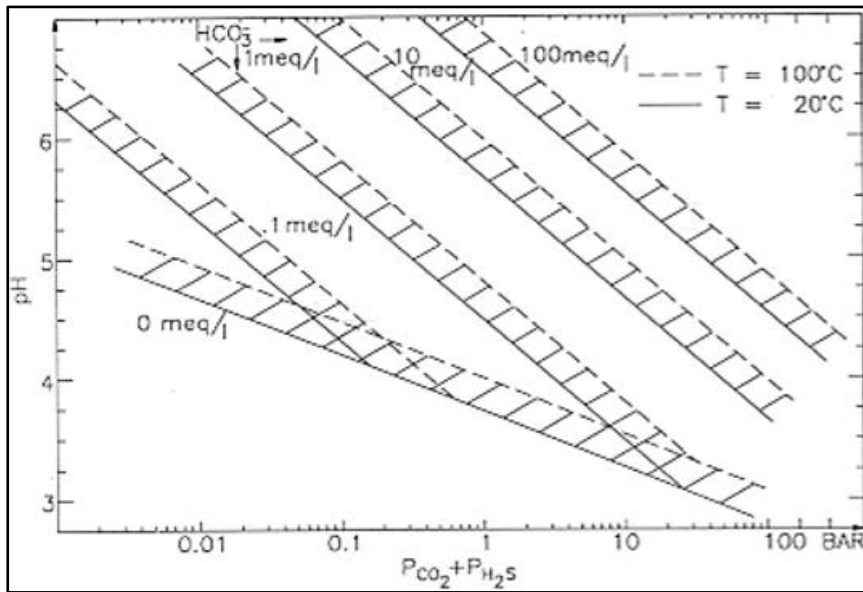

(HCO₃⁻) concentration in the water.

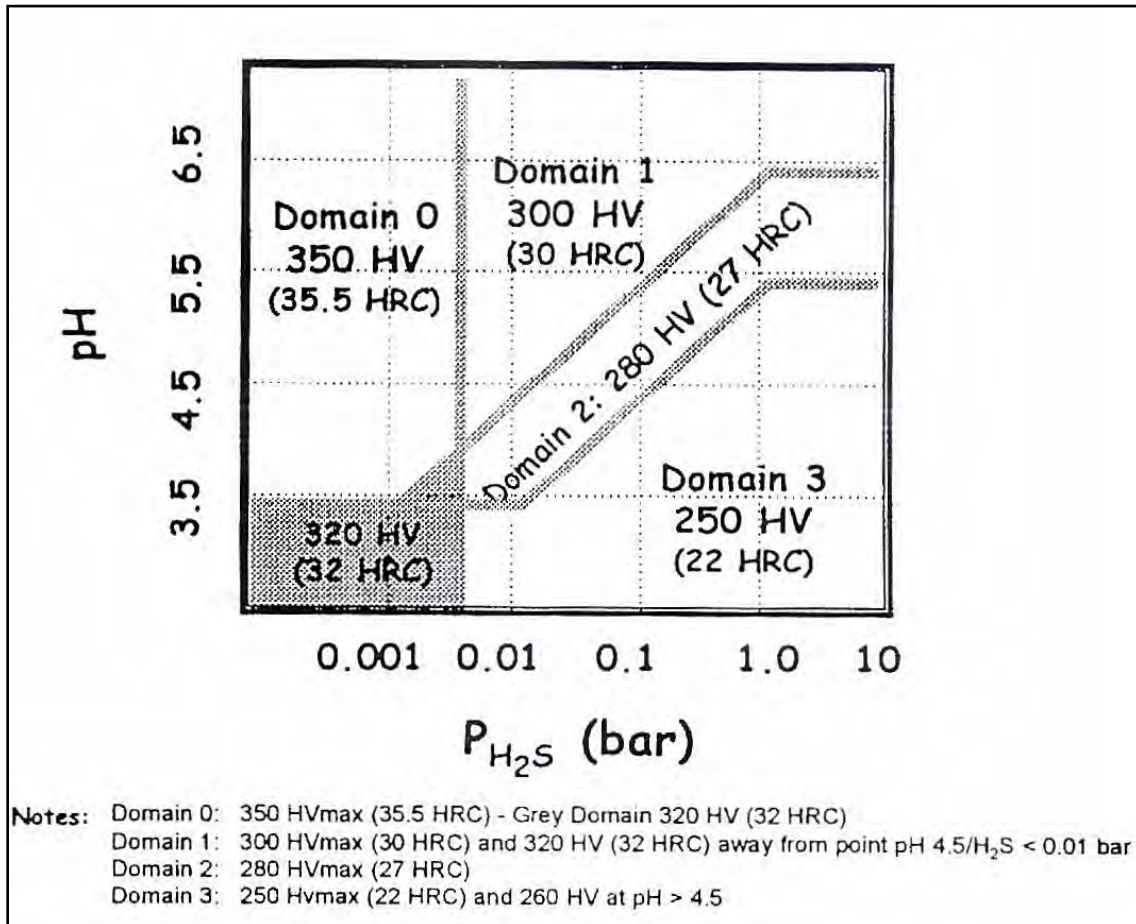
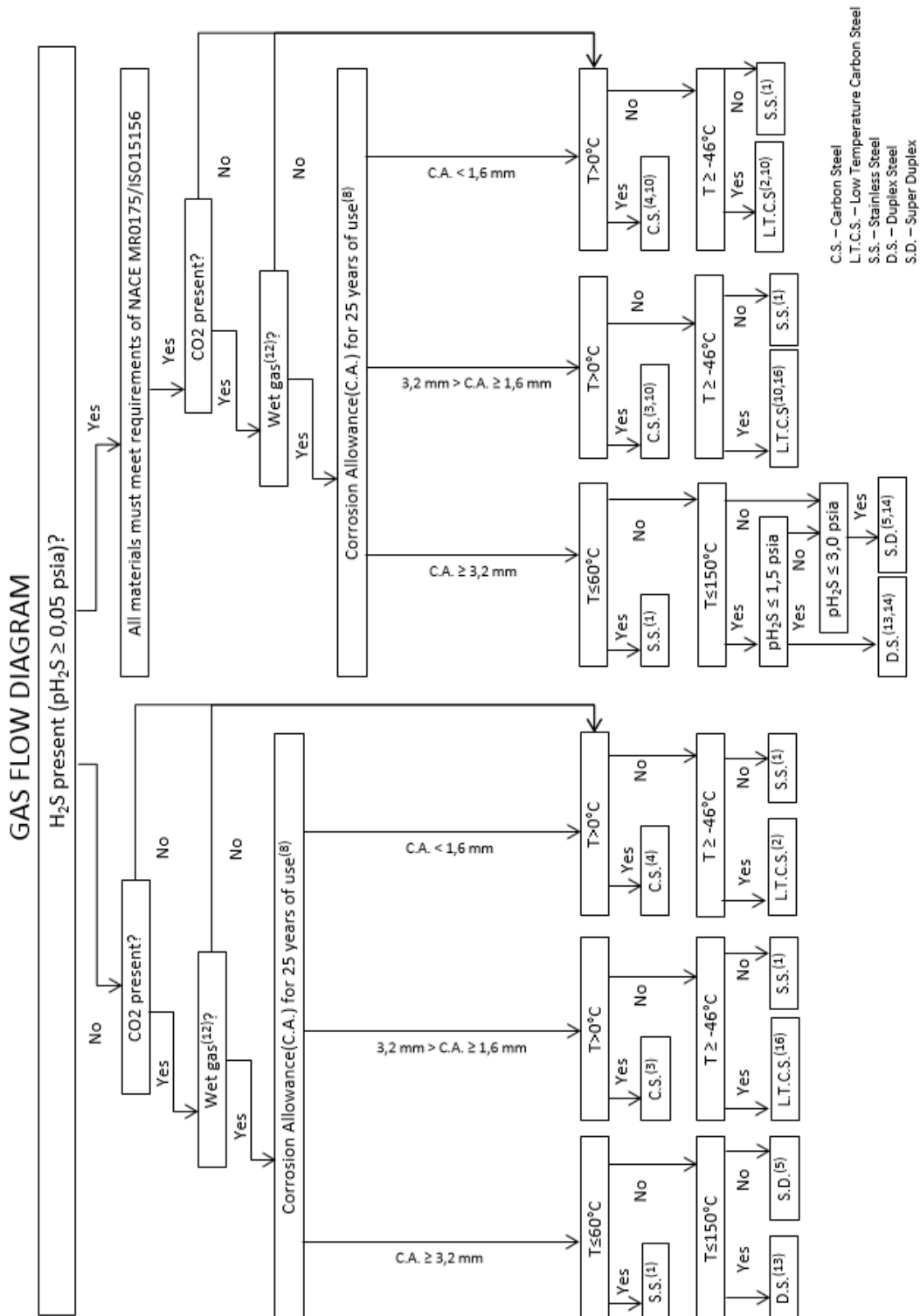

Figure D.3 – Diagram of hardness limits for steel type API 5L proposed for sour service in function of the pH and the H₂S partial pressure.

D.3.4. GASEOUS HYDROCARBON FLOW DIAGRAM



D.4. MULTIPHASE HYDROCARBON

For multiphase flow of liquid, gaseous hydrocarbons and water we recommend the graphs set out on the attached sheet, Figures 1 and 2, which consider the partial pressures of H₂S and CO₂, the pH of the medium and hardness of the exposed material as parameters to check the degree of corrosiveness (Ref.3). For a good estimate of the pH, a software or a chemical model capable to calculate the pH based on the partial pressures of the gases and the chemical composition of the water can be used.

A water cut higher than 30% can impede that the present oil exercises an efficient action in the prevention of the corrosion favoring the oil/water separation.

D.4.1. MULTIPHASE HYDROCARBON FLOW DIAGRAM

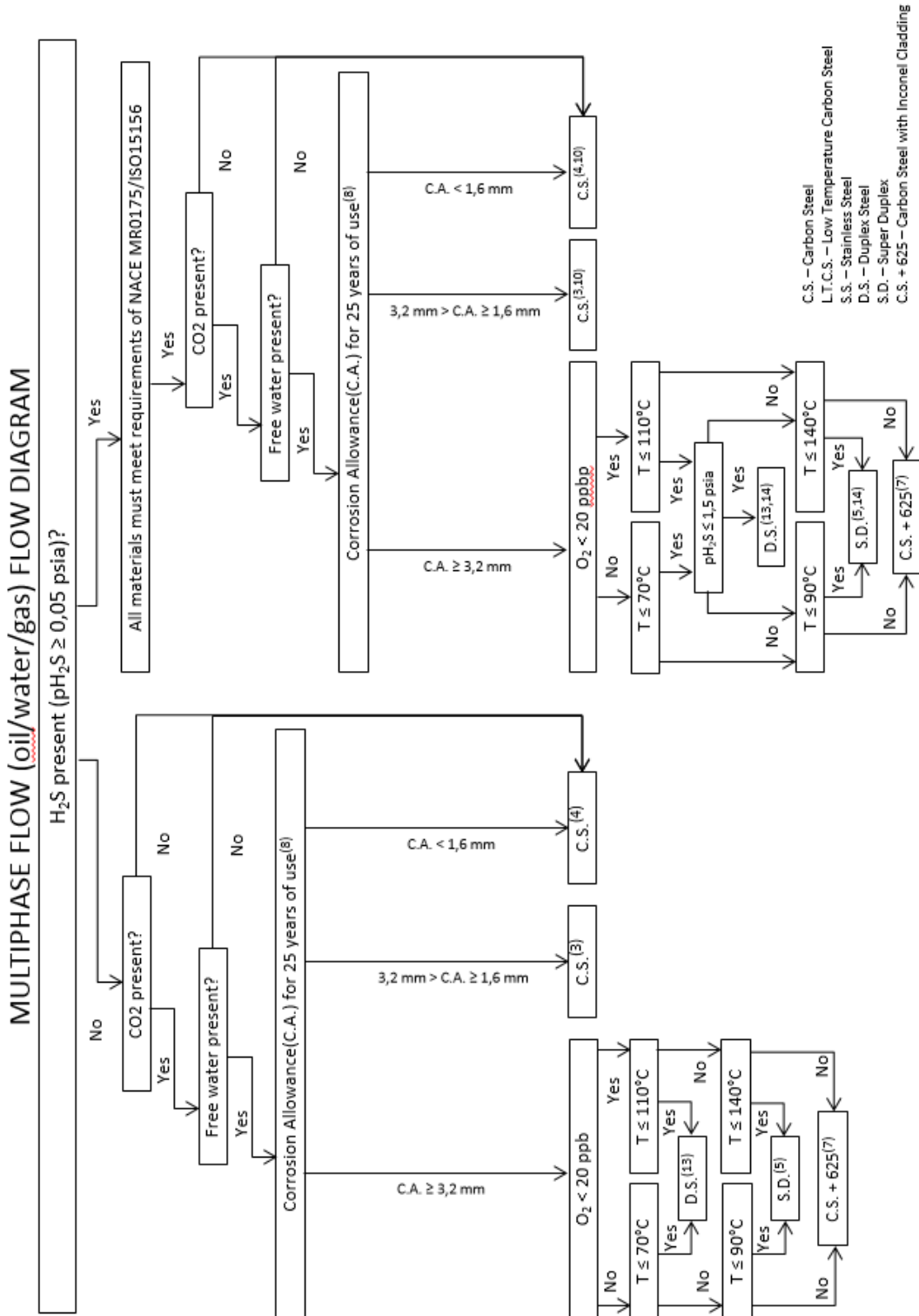

D.5. PRODUCED WATER

D.5.1. SELECTION OF PRODUCED WATER PIPING SPECIFICATION

Maximum Temperature	Spec	Material	Observations
60°C	B25	RPVC	Onshore Installations
Up to 120°C	B26	FRP	Offshore and Onshore Installations.
Up to 150°C	B11 C11 E11 F11 G11 H11	CS + Organic Coating, according to I-ET-3010.1M-1200-956-P4X-002.	Offshore and Onshore Installations. Temperature limits of coating product shall be observed, according to I-ET-3010.1M-1200-956-P4X-002.
Up to 120°C	B12 C12	Superduplex	O ₂ max content 20 ppb

Notes:

- 1) B3, C3, E3, F3, G3, H3. (316L)
- 2) B6, C6, E6, F6, G6. (A 333 Gr. 6)
- 3) B9, C9, E9. (API 5L Gr. B), F3, G3. (316L)
- 4) B10, C10, E10, F10, G10, G10P. (API 5L Gr. B)
- 5) B12, C12, G12, H12, J12 (Super Duplex Stainless Steel)
- 6) B25 (RPVC)
- 7) Carbon Steel API 5L grade B + Liner (or Clad) Inconel alloy 625.

- 8) CO₂ corrosion rate shall be calculated according to program for evaluation and determination of corrosion of steels NORSOK M-506.
- 9) ACR - Annual Corrosion Rate (mm/year); HAZ – Heat Affected Zone
- 10) Requirements for Carbon Steel materials and equipment for services with H₂S:
 - a) Materials and equipment shall fully comply with the requirements of ISO 15156, NACE TM 0177 and NACE TM0284;
 - b) At least three rows of tests shall be accomplished in the case of NACE TM 0177 and NACE TM 0284;
 - c) For each test condition, set in the standard, at least three samples shall be tested;
 - d) At least two of the three samples shall be considered approved;
 - e) In the case of the NACE TM 0177, the test shall be performed for at least thirty days, with continuous H₂S bubbling;
 - f) Regarding NACE TM 0284, the “A” Solution shall be used. The maximum acceptable CLR index shall be 1% and the maximum acceptable CTR index shall be 0,5%.
 - g) Considering NACE TM0177, the “B” Solution shall be chosen. The test shall be performed using the “A” Method for the base metal and “C” Method for the welded joint. The applied load shall correspond to 90% of yield limit specified for the base metal and 85% of the yield limit for the welded joint;
 - h) The qualification of all welding procedures shall include the tests fixed in items “E” and “G” of this specification;
 - i) During the qualification of the welding procedure, the Vickers hardness profile shall be recorded with a 5Kg load (HV5) over the thermally zone (HAZ) of the welded joint and the highest value found shall be identified;
 - j) For the tests according to NACE TM0177, samples with the Maximum Equivalent Carbon, the highest yield stress and the highest hardness shall be chosen;
 - k) The welding of specimens shall be performed with the heat input of at least 90% of the heat input specified in the qualified welding procedure;
 - l) The welding fillets shall be performed always from the base metal to the welding metal so that to temper the thermally affected zone (HAZ);
 - m) The welding HV5 hardness values shall be lower than the highest hardness obtained in the welding procedure qualification;
- 11) B11, C11, E11, F11, G11 and H11
- 12) Operation temperature should be 10°C higher than the gas dew point;
- 13) B16, C16, E16, G16, G16P, H16
- 14) Requirements for Duplex (22 Cr) and Super Duplex (25 Cr) materials and equipment for services with H₂S:
 - a) Maximum hardness for Duplex = 310 HV10 / 28 HRc and Super Duplex = 330 HV10/32 HRc
 - b) PREN for Duplex > 30 ; PREN for Super Duplex > 40
 - c) Ferrite content (volumetric fraction) for Duplex and Super Duplex shall be between 35% and 65%
- 15) B17, E17 (API 5L Gr B)
- 16) B19, G19 (A 333 Gr 6)

ANNEX E

FLANGE ISOLATION KITS (Mandatory)

INDEX

E.1. SCOPE	3
E.2. GENERAL DESCRIPTION	3
E.3. RECOMMENDED USE.....	3
E.4. ASSEMBLY	4
E.5. REQUIREMENTS	5
E.6. DESCRIPTION FOR COMMON TYPES OF ISOLATION KITS.....	5
E.7. MARKING.....	6

E.1. SCOPE

This document defines minimum technical requirements and conditions for purchasing flange electric isolation kits for Exploration and Production (E&P) business area, onshore and offshore, especially in oil and gas production and their process facilities.

The flange isolation kit contains gasket, bolt sleeves and washers.

E.2. GENERAL DESCRIPTION

The flange kit isolations shall be manufactured from isolating material having low water absorption, high compressive strength and high dielectric strength.

Materials shall be applied taking account the operating conditions as temperature, pressure and fluid.

The flange isolation kit contains the following items:

Table E.1 – Isolation Kit items

Isolation Gasket	1 pc
Isolation Sleeve	1 pc per flange bolt
Isolation Washers	2 pcs per flange bolt
Metallic Washers	2 pcs per flange bolt

E.3. RECOMMENDED USE

The use of flange isolation kit is recommended whenever two metals come into in an electrolyte with different electrode potentials.

Table E.2 give cases where flange isolation kit shall be applied.

Flange isolation kit is not required for instruments connection.

The Contractor is responsible for indicating and applying the isolation kit wherever it is necessary.

Table E.2 – Flange Isolation kit recommendation

Service code	Service description	Pipe Specs	Material 1	Material 2									
				CuNi 90/10	Bronze	Carbon Steel	Stainless Steel	Duplex	Super Duplex	3 1/2 Ni	9 Ni	Inconel	Carbon Steel Inconel clad
FW	Fire Water (Aerated Seawater)	B7; B7R, B7H, S7	CuNi 90/10			Y					Y	Y	
HWU	Utility Heating Water	B4; F10	Carbon Steel	Y	Y		Y	Y	Y				Y Y
IW	De-Aerated Seawater Injection	B10; C10; E10; F10; G10	Carbon Steel	Y	Y		Y	Y	Y				Y Y
IW	De-Aerated Seawater Injection	C30; H30	Carbon Steel Inconel clad			Y					Y	Y	
PCW	Produced Water	B12; C12	SuperDuplex			Y					Y	Y	
SW	Seawater	B7R	CuNi			Y					Y	Y	

E.4. ASSEMBLY

In order to avoid damage during installation and tightening, shall be followed the manufacturer installation guide.

Before installation, the isolation kit shall be checked and their surfaces must be free from imperfection as cracks and grooves.

Special attention shall be given to the correct position of metallic washers as demonstrated in Figure E.1. Due to washers and gasket thickness, it might be necessary bolts longer than the ones from the spec.

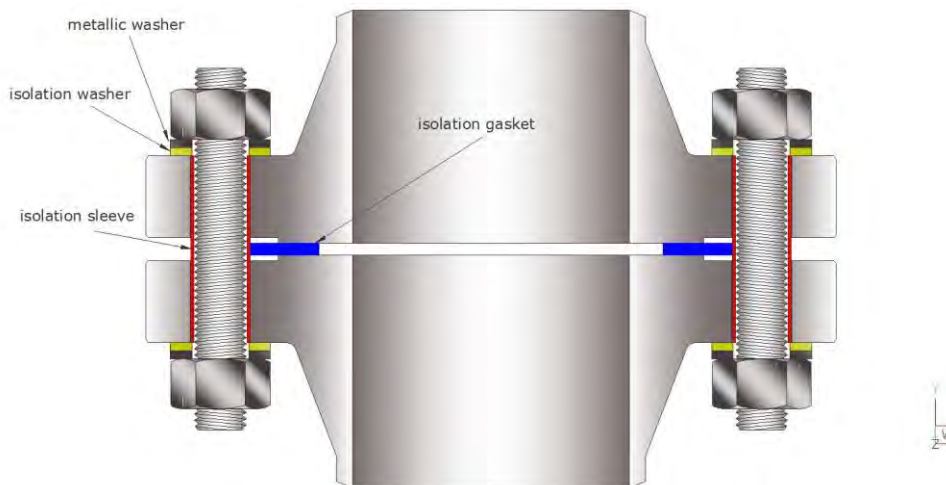

Figure E.1 – Example of RF flange kit isolation assembly.

E.5. REQUIREMENTS

The manufacturer shall present third party certificates issued by certified laboratories meeting the standards and reference values listed below:

Table E.2 – Minimum Requirements for isolation Kits

Property	Standard	Value
Dielectric Strength	ASTM D149 (short time)	500 Volts/mil
Insulation Resistance	ASTM D257	40000 Megohms
Compressive Strength	ASTM D695	25000 psi
Water absorption	ASTM D229	1.6% (maximum)

E.6. DESCRIPTION FOR COMMON TYPES OF ISOLATION KITS

Table E.3 contains examples for common specifications of isolation kits. The requirements listed in item E.5 must be added on the purchase order.

Table E.3 – Examples for Isolation Kit specification (note 1 and note 2)

CLASS	TAG	Flange	Temperature Limits	Description
150 300	J-150-DY J-150-FY J-300-FY	150# FF 150# RF 300# RF	75°C	Phenolic gasket faced on both sides with Nitrile rubber; thickness 3,2 mm. G-10 isolating sleeves; two G-10 isolation washer and two hardened carbon steel washer Zn-Ni coated per bolt.
150 300	J-150-DA J-150-FA J-300-FA	150# FF 150# RF 300# RF	75°C	Isolation aramid fiber with Nitrile rubber gasket; thickness 3,2 mm. G-10 isolating sleeves; two G-10 isolation washer and two hardened carbon steel washer Zn-Ni coated per bolt.
150 300 600 900 1500 2500	J-150-FZ J-300-FZ J-600-FZ J-900-HZ J-1500-HZ J-2500-HZ	150# RF 300# RF 600# RF 900# RTJ 1500# RTJ 2500# RTJ	150°C	Metallic gasket, core in stainless steel 316 faced on both sides with insulation composite G-10, PTFE sealing ring. G-10 isolating sleeves; two G-10 isolation washer and two hardened carbon steel washer Zn-Ni coated per bolt.
150 300 600 900 1500 2500	J-150-FX J-300-FX J-600-FX J-900-HX J-1500-HX J-2500-HX	150# RF 300# RF 600# RF 900# RTJ 1500# RTJ 2500# RTJ	150°C	Metallic gasket, grooved core in stainless steel 316 faced on both sides with PTFE. G-10 isolating sleeves; two G-10 isolation washer and two hardened carbon steel washer Zn-Ni coated per bolt.

Note 1 – Alternative washer and sleeve material that may be applied in place of G10: Mylar and G11.

Note 2 - Other types of isolation kits are permitted. Table E.4 gives the minimum specifications to orientate purchase orders.

Table E.4 – Form example with general specification for other types of isolation kits

General description		Flange electric isolation set: Isolation Gasket 1 pc Isolation Sleeve 1 pc per flange bolt Isolation Washers 2 pcs per flange bolt Metallic Washers 2 pcs per flange bolt
Flange standard		
Flange facing and class		
Operating condition	Temperature (°C)	
	Pressure (bar)	
	Fluid	
Additional requirements		See Annex E Table E.2
Certificates		See Annex E
The manufacturer shall present installation guide, including torque values.		

E.7. MARKING

The following information shall be clearly stated on label attached to external surface of each isolation joint:

- Manufacturer's name or trademark;
- Nominal pipe size;
- Pressure class or Maximum operating pressure;
- Maximum operating temperature;
- Serial number.

ANNEX F

REQUIREMENTS FOR PIPING INTERNAL COATING (Cancelled)

**The content of this annex was transferred to
I-ET-3010.00-1200-956-P4X-002 – GENERAL PAINTING**

ANNEX G

WELDING REQUIREMENTS

(Cancelled)

**The content of this annex was transferred to
I-ET-3010.00-1200-955-P4X-001 - WELDING**

ANNEX H

REQUIREMENTS FOR FRP PIPES AND FITTINGS

(MANDATORY)

INDEX

REQUIREMENTS FOR FRP PIPES AND FITTINGS	1
(MANDATORY)	1
H.1.SCOPE	3
H.2.REFERENCES	3
H.3.SYMBOLS AND ABBREVIATED TERMS	3
H.4.FABRICATION PROCESS.....	3
H.4.1. CHEMICAL BARRIER.....	3
H.4.2. STRUCTURAL LAYER	3
H.4.3. EXTERNAL LINER.....	3
H.4.4. ADDITIVES	4
H.5.MINIMUM STRUCTURAL THICKNESS.....	4
H.6.MATERIALS SELECTION	4
H.7.FIRE PERFORMANCE.....	5
H.8.GENERAL REQUIREMENTS	5
H.9.IDENTIFICATION	6
H.10. STORAGE AND PRESERVATION.....	6
H.11. HANDLING AND TRANSPORT.....	6

H.1. SCOPE

This ANNEX determines the minimum required conditions for the fabrication, qualification and purchase of fiberglass reinforced thermoset resin based composite (FRP) piping and fittings systems, for offshore applications. The nominal diameters vary from 1" to 48", for several aqueous products.

H.2. REFERENCES

Note: The Standards referred herein shall be considered in their latest edition/revision.

ISO 14692 - Petroleum and Natural Gas Industries - Glass-Reinforced Plastics (GRP) piping (parts 1 to 4);

ASTM F 1173 – Standard Specification for Thermosetting Resin Fiberglass Pipe Systems to Be Used for Marine Applications;

IMO Resolution A.753 (18): 1993 – Guidelines for the application of plastic pipes on ships;

EN-DIN 13121 – GRP tanks and vessels for use above ground

NORSOK M 622 - Fabrication and installation of GRP piping systems;

I-ET-3010.00-1200-200-P4X-003 - Design, Construction and assembly of FRP Piping

H.3. SYMBOLS AND ABBREVIATED TERMS

For the purposes of this document, the following terms and definitions apply:

FRP – Fiber-Reinforced Plastic

H.4. FABRICATION PROCESS

Pipes and fittings shall be manufactured by filament winding of fiberglass beams (rovings) impregnated with resin, following ISO 14692 - Part 2.

H.4.1. CHEMICAL BARRIER

The chemical barrier shall be used only for aggressive fluids (acidic and base solutions, other chemical compounds, like sodium hypochlorite). In this cases, the barrier shall be at least 2.5 mm thick. The resin content is indicated to be between 55% and 75%. Chemical barriers thicknesses shall be calculated considering EN 13121-2 standard for fluids other than water.

H.4.2. STRUCTURAL LAYER

This layer shall be made of thermosetting resin reinforced with fiberglass type E or E-CR. The same resin shall be applied to the internal liner and chemical barrier (if applicable). If not, the resins shall have at least the same base (epoxy or vinyl ester) and be compatible, to promote strong interaction between the layers. This layer shall be free of pigments.

H.4.3. EXTERNAL LINER

The external layer shall consist of pure resin, the same used in structural layer, or have a polyester veil for improved protection. It shall contain dark pigment (with carbon black) or be without pigmentation, in order to be painted. The formulation of this layer shall contain additives for 50 years life UV protection.

Graphite shall be added to the resin to decrease the surface resistivity. "Rovings" of carbon fibers may be added during the manufacturing process to ensure electrical continuity, complementing the graphite. It is not acceptable color variation in the same tube and it shall have a polished / smooth aspect.

At least, the outer layer shall have a thickness of 0.5 mm.

H.4.4. ADDITIVES

The epoxy resin shall be pigmented with dark colors, which contain the carbon black pigment, as secondary protection to ultraviolet radiation. The lack of pigmentation is also an option, to facilitate inspection.

It is mandatory that all vinyl-ester pipes and fittings have, in their outer layers, the anti-UV additive in sufficient concentration, considering life cycle of 50 years.

Graphite and carbon black can be used as an additive to the resin as a way of decreasing the surface resistivity. This can be used as an alternative to the application of carbon fibers (rovings) in the last (outer) layers, with the same purpose. The electrical resistivity shall be calculated according to ISO 14692 – part 2 – Annex G. For reaching volumetric electrical resistivity requirements, it shall be used carbon fiber rovings in pipe structure, tested as ISO 14692 – part 2 – code C1a.

Flame retardants additives such as antimony trioxide or tri-hydrated alumina, when applied shall be at the concentration indicated by the manufacturer, accomplishing fire endurance and fire reaction requirements of the qualification program ISO 14692.

H.5. MINIMUM STRUCTURAL THICKNESS

The total thickness of a tube made of FRP is defined as the sum of the thickness of the structural layer, with the inner or internal liner, the chemical barrier layer and the outer or external liner. The structural calculations shall be according to ISO 14692-2 and consider only the structural layer as thickness for calculations.

The minimum structural thickness shall be 5.0 mm, for diameter equal or larger than 100 mm (4").

H.6. MATERIALS SELECTION

The recommended manufacturing materials for the tubes depend on the fluid being transported, according to Table H.1. Owner and manufacturer are responsible for the final decision of materials to be used.

For produced water and fire water applications, it shall be used specific epoxy resin + curing agent for continuous operation of 120°C.

Table H.1 – Required materials for pipe manufacturing as a function of service fluid.

SERVICE	STRUCTURAL LAYER	CHEMICAL BARRIER
Aerated Sea Water Injection Water Others Waters	Bisphenol A Epoxy resins (DGEBA) (note 1), reinforced with fiberglass (type E ou E-CR)	–
Fire Water (note 3) Produced Water	Bisphenol A Epoxy resins (DGEBA), reinforced with fiberglass (type E ou E-CR)	–
Concentrated Sodium hypochlorite	Epoxy vinylester resin (bisphenol A or brominated) reinforced with fiberglass (type E- CR). (note 2)	Epoxy vinylester resin (bisphenol A or brominated) reinforced with fiberglass (type E- CR). (note 2)
Note 1: Curing agents, aromatic or aliphatic cycle, must be used for epoxy resin. An alternative is the use of vinyl ester resin. In special cases, other resins and curing agents may be used if approved by PETROBRAS.		
Note 2: The cure of vinyl ester resin for use with sodium hypochlorite should be with BPO/DMA (no cobalt). A Post-cure should be applied and the chemical barrier shall be a minimum of 2.5 mm plus 0.5 mm liner. The use of brominated vinylester resin is mandatory.		
Note 3: Fire water systems in FRP (ring main and wet/dry deluge) are only permitted for fixed platforms in Petrobras. The fire integrity level (L1, L2, L2W, L3 or LWD) shall be designed for each part of the system.		

H.7. FIRE PERFORMANCE

For the purposes of this document the FRP pipes and fittings shall attend at minimum to L3 IMO A.753 (18) requirements.

Fire Protection Coating: For pipes to be applied in unprotected location, without physical protection and with high possibility of being hit by fire (considered in fire propagation study or indicated by Process Safety Risk Analysis), or fire water pipes, the intumescent coating shall be applied externally to the pipe and fittings. The specification of this coating shall have the approval of owner, as its qualification shall be proven by certification tests.

The tests described in ISO 14692 / ABNT NBR 15921 - Part 2 - Item 6.5 and Appendix E are equivalent to tests of IMO Resolution A.753, as described in item E.1.1. For the purposes of this document, manufacturers shall conduct tests according to IMO A.753 for pipes and fittings and these shall receive the L1, L2, L3, L2W and LWD classifications.

H.8. GENERAL REQUIREMENTS

In order to minimize water hammer occurrence, butterfly and gate valves shall be preferentially selected.

Shall be followed the criteria for design, construction, assembly and inspection of FRP piping system established in the technical specification I-ET-3010.00-1200-200-P4X-003.

H.9. IDENTIFICATION

Identification of pipes and fittings shall be in accordance with ISO 14692 - Part 2 - Item 9.

H.10. STORAGE AND PRESERVATION

The storage and preservation of items of composite pipe shall be in accordance with ISO 14692 - part 4 - Annex B.

H.11. HANDLING AND TRANSPORT

The handling and transportation of composite piping items shall be in accordance with ISO 14692 - part 4 - Annex B.

ANNEX J

PIPING WELD INSPECTION

(Cancelled)

**The content of this annex was transferred to
I-ET-3010.00-1200-955-P4X-002 - REQUIREMENTS FOR
WELDING INSPECTION**

ANNEX K

PRESSURE-SAFETY VALVES

(Mandatory)

INDEX

K.1.SCOPE	4
K.2.NORMATIVE REFERENCES	4
K.3.SYMBOLS AND ABBREVIATED TERMS	4
K.4.VALVE SELECTION GUIDE	4
K.5.GENERAL DESIGN REQUIREMENTS	5
K.6.VALVE CODE RULE	5
K.7.TRIM MATERIAL	6
K.8.APPLICATION TABLE	7
K.9.PSV VALVES DATASHEETS	11

TABLES

TABLE K.1 – DEFINITION OF ACCUMULATED ENERGY AND HIGH DEMAND.....	4
TABLE K.2 – VALVE SPECIFICATION LEVEL (VSL) CLASSIFICATION.....	5
TABLE K.3 – CODE FOR FLANGE CLASS	6
TABLE K.4 – BODY MATERIAL CLASS ACCORDING TO MATERIAL TYPE AND NUMBER...6	6
TABLE K.5 – TRIM MATERIAL CONFIGURATION FOR PSVS.....	7
TABLE K.6 – APPLICABLE SPECS PER VALVE CODE.....	7

K.1. SCOPE

This document defines minimum technical requirements and conditions for purchasing pressure-safety valves (PSV) for Exploration and Production (E&P) business area, onshore and offshore, especially in oil and gas production and their process facilities.

K.2. NORMATIVE REFERENCES

- API STD 520 - Sizing, Selection, and Installation of Pressure-relieving Devices Part I
- API STD 520 - Sizing, Selection, and Installation of Pressure-relieving Devices in Refineries Part II
- API STD 526 - Flanged Steel Pressure-relief Valves
- API STD 527 - Seat Tightness of Pressure Relief Valves

K.3. SYMBOLS AND ABBREVIATED TERMS

For the purposes of this annex, the following symbols and abbreviated terms apply:

- P&ID Process and instrumentation diagram
- PSV Pressure Safety Valve / Pressure Relief Valve
- VDS Valve Datasheet
- VSL Valve Specification Level
- SPEC Piping material specification

K.4. VALVE SELECTION GUIDE

This item presents general information, such as a guide of how shall be conducted the engineering process to select a valve for use in the Project and/or specific application.

The indication of all valves shall be driven by the definition of Valve Specification Level (VSL), which regulates the specification of an adequate valve for a certain application, taking into account the criticality foreseen in the application/use of the valve.

The VSL classification will provide two levels of specification: VSL-1 and VSL- 2. These two VSLs designations define different levels of technical requirements. For VSL-1, the leakage acceptance criteria is in accordance with API 527. For VSL-2, the leakage acceptance criteria shall be half of those presented in API 527.

The determination of the VSL is obtained by the classification rules stated on Table K.1 and Table K.2.

The manufacturer of the valve shall attend all requirements listed in the VDS, including the specific requirements of VSL.

Table K.1 – Definition of accumulated energy and high demand

Accumulated Energy	High	Valves of Pressure Class 600 and 900, NPS ≥ 6 Valves of Pressure Class 1500, 2500 and 10.000psi
	Low	Valves of Pressure Class 125, 150 and 300 Valves of Pressure Class 600 and 900, NPS ≤ 4

Table K.2 – Valve Specification Level (VSL) classification

	Service	Accumulated Energy	VSL	
Other valves	Hydrocarbon Hot water Inflammable	High	VSL-2	
		Low	VSL-2	
	Steam Toxic	High	VSL-2	
		Other services	High	VSL-2
			Low	VSL-1

K.5. GENERAL DESIGN REQUIREMENTS

Orifice calculations shall be done according to API STD 520.

PSV design shall be according the standards referenced in the VDS. In case of conflict between the requirements herein established and that standard, the attendance of this document shall be considered as mandatory.

The manufacturer shall present all dimensional drawings of the PSV, with a list of all parts and materials specifications.

All metallic materials shall have a mill certification, with registers of chemical composition, mechanical properties and other standards requirements, besides the manufacturer batch identification.

K.5.1. MARKING AND NAMEPLATE

All valves shall be marked in accordance with the requirements stated on the design standard referenced in the VDS.

Each valve shall be provided with an austenitic stainless steel nameplate securely affixed and so located that it is easily accessible.

The nameplate shall present information in accordance with the requirements stated on the design standard referenced in the respectively VDS, plus the additional data:

- a) Indication about the VSL of the valve: VSL-1 or VSL-2.
- b) PSV tag informed in P&ID.

K.6. VALVE CODE RULE

All PSVs specified for application in Exploration and Production (E&P) oil production and process facilities have a unique code, in order to have uniformity and to systematize the coding of PSVs so that they can be handled in an organized manner and information can be easily retrieved.

The complete structure of all PSV codes shall be as follows:

PSV-XY-Z-MMAB

Where:

X – Upstream flange class, in accordance with table K.3;

Y – Downstream flange class, in accordance with table K.3;

Z – Valve Specification Level (VSL), in accordance with table K.2;

MM – PSV Body Material Class, according to Table K.4;

A – Valve Type (0 = Conventional; 1 = Balanced with trim A; 2 = Balanced with trim B);

B – Orifice designation, as per API 526.

Table K.3 – Code for flange class

Pressure Class	150	300	600	900	1500	2500	10000
Code X and Y	B	C	E	F	G	H	J

Table K.4 – Body Material class according to material type and number

Material number	Material type			
	C	D	N	S
	Carbon steel	Duplex steel	Nickel alloys	Stainless steel
1	ASTM A216 WCB	-	Inconel 625 (UNS N06625)	-
2	ASTM A352 LCB	ASTM A995 Gr. 4A	-	ASTM A351 Gr. CF8M
3	-	ASTM A995 Gr 6A	-	-

Example: PSV-GC-2-S21K
 Upstream flange class (G): 1500
 Downstream flange class (C): 300
 VSL: 2
 PSV Body Material Class (S2): ASTM A351 CF8M
 Valve Type (1): balanced with trim A
 Orifice designation: K (effective area = 1.838 in²)

K.7. TRIM MATERIAL

Materials for internal parts (trim) are described in VDSs (item K.9). The criteria for their selection is in accordance with Table K.5.

Table K.5 – Trim material configuration for PSVs

Material Class	Body Material	Bonnet material	Disc Material	Nozzle Material	Guide	Stem (spindle)	Spring	Bellows
C1	ASTM A216 Gr WCB	ASTM A216 Gr WCB	Martensitic SS 400 Series	AISI 316	AISI 316	Martensitic SS 400 Series	UNS N07750	UNS N06625
C2	ASTM A352 Gr LCB	ASTM A352 Gr LCB	AISI 316 + Stellite	AISI 316				
D2	ASTM A995 4A	ASTM A995 4A	ASTM A479 (UNS S31803)	ASTM A479 (UNS S31803)				
D3	ASTM A995 6A	ASTM A995 6A	ASTM A479 (UNS S32760)	ASTM A479 (UNS S32760)				
N1	UNS N06625	UNS N06625	UNS N06625	UNS N06625				
S2 Type 1 (trim A)	ASTM 351 CF8M	ASTM A351 CF8M	AISI 316 + Stellite	AISI 316				
S2 Type 2 (trim B)	ASTM 351 CF8M	ASTM A351 CF8M	Hastelloy C	Hastelloy C				

K.8. APPLICATION TABLE

The table K.6, below presents all possible valve codes and their respective applicable specs. All possible orifices for each valve code are applicable, as presented in third column of the Table K.6.

Table K.6 – Applicable specs per valve code

VALVE DATASHEET	SPEC	ORIFICES
PSV-BB-1-C10	B4 B5 B9 B10 B17 B10H	D, E, F, G, H, J, K, L, M, N, P, Q, R, T
PSV-BB-2-C10		
PSV-BB-1-C11		
PSV-BB-2-C11		
PSV-CB-1-C10	C4 C5 C9 C10 C10P C10H	D, E, F, G, H, J, K, L, M, N, P, Q, R, T
PSV-CB-2-C10		
PSV-CB-1-C11		
PSV-CB-2-C11		
PSV-EB-1-C10	E4 E5 E9 E10 E10R E17	D, E, F, G, H, J, K, L, M, N, P, Q, R, T
PSV-EB-2-C10		
PSV-EB-1-C11		
PSV-EB-2-C11		
PSV-FB-1-C10	F4 F5 F10 F10R	H, J, K, L, M, N, P
PSV-FB-2-C10		
PSV-FB-1-C11		
PSV-FB-2-C11		
PSV-FC-1-C10		D, E, F, G,
PSV-FC-2-C10		
PSV-FC-1-C11		
PSV-FC-2-C11		

PSV-GB-2-C10	G4 G5 G10 G10P G10R	L
PSV-GB-2-C11		D, E, F, G, H, J, K
PSV-GC-2-C10		
PSV-GC-2-C11		
PSV-HC-2-C10	H5 H10 H10P	D, E, F, G
PSV-HC-2-C11		
PSV-BB-1-C20	B6 B9 B10 B17 B19 B10H	D, E, F, G, H, J, K, L, M, N, P, Q, R, T
PSV-BB-2-C20		
PSV-BB-1-C21		
PSV-BB-2-C21		
PSV-CB-1-C20	C6 C9 C10 C10P C10H	D, E, F, G, H, J, K, L, M, N, P, Q, R, T
PSV-CB-2-C20		
PSV-CB-1-C21		
PSV-CB-2-C21		

Table K.6 – Applicable specs per valve code (continued)

VALVE DATASHEET	SPECs	ORIFICES
PSV-EB-1-C20	E6 E9 E10	D, E, F, G, H, J, K, L, M, N, P, Q, R, T
PSV-EB-2-C20		
PSV-EB-1-C21		
PSV-EB-2-C21		
PSV-FB-1-C20	F6 F10 F10P	H, J, K, L, M, N, P
PSV-FB-2-C20		
PSV-FB-1-C21		
PSV-FB-2-C21		D, E, F, G
PSV-FC-1-C20		
PSV-FC-2-C20		
PSV-FC-1-C21	G6 G10 G10P G19	L
PSV-FC-2-C21		D, E, F, G, H, J, K
PSV-GB-2-C20	H6 H10 H10P	D, E, F, G
PSV-GB-2-C21		
PSV-GC-2-C20	B30	D, E, F, G, H, J, K, L, M, N, P, Q, R, T
PSV-GC-2-C21		
PSV-HC-2-C20	C30	D, E, F, G, H, J, K, L, M, N, P, Q, R, T
PSV-HC-2-C21		
PSV-BB-1-N11	E30	D, E, F, G, H, J, K, L, M, N, P, Q, R, T
PSV-BB-2-N11		
PSV-FB-1-N11	F30	H, J, K, L, M, N, P
PSV-FB-2-N11		
PSV-FC-1-N11		D, E, F, G
PSV-FC-2-N11		
PSV-HC-2-N11	H30	D, E, F, G
PSV-BB-1-D21	B16 B16H	D, E, F, G, H, J, K, L, M, N, P, Q, R, T
PSV-BB-2-D21		
PSV-CB-1-D21	C16	D, E, F, G, H, J, K, L, M, N, P, Q, R, T
PSV-CB-2-D21		
PSV-EB-1-D21	E16	D, E, F, G, H, J, K, L, M, N, P, Q, R, T
PSV-EB-2-D21		
PSV-FB-1-D21	F16	H, J, K, L, M, N, P
PSV-FB-2-D21		
PSV-FC-1-D21		D, E, F, G
PSV-FC-2-D21		

Table K.6 – Applicable specs per valve code (continued)

VALVE DATASHEET	SPEC	ORIFICES
PSV-GB-2-D21	G16 G16P	L
PSV-GC-2-D21		D, E, F, G, H, J, K
PSV-HC-2-D21	H16 H16H	D, E, F, G
PSV-BB-1-D31	B12	D, E, F, G, H, J, K, L, M, N, P, Q, R, T
PSV-BB-2-D31		
PSV-CB-1-D31	C12	D, E, F, G, H, J, K, L, M, N, P, Q, R, T
PSV-CB-2-D31		
PSV-GB-2-D31	G12 G12P	L
PSV-GC-2-D31		D, E, F, G, H, J, K
PSV-HC-2-D31	H12 H12P	D, E, F, G
PSV-BB-1-S21	B3 B6 B9 B10 B17 B19 B10H	D, E, F, G, H, J, K, L, M, N, P, Q, R, T
PSV-BB-2-S21		
PSV-CB-1-S21	C3 C6 C9 C10 C10P C10H	D, E, F, G, H, J, K, L, M, N, P, Q, R, T
PSV-CB-2-S21		
PSV-EB-1-S21	E3 E6 E9 E10	D, E, F, G, H, J, K, L, M, N, P, Q, R, T
PSV-EB-2-S21		
PSV-FB-1-S21	F3 F6 F10 F10P	H, J, K, L, M, N, P
PSV-FB-2-S21		
PSV-FC-1-S21		D, E, F, G
PSV-FC-2-S21		
PSV-GB-2-S21		G3 G6 G10 G10P G19
PSV-GC-2-S21	D, E, F, G, H, J, K	
PSV-HC-2-S21	H3 H6 H10 H10P	D, E, F, G
PSV-BB-1-S22	B14 B14H	D, E, F, G, H, J, K, L, M, N, P, Q, R, T

K.9. PSV VALVES DATASHEETS

A.12.1 PRESSURE-SAFETY VALVES

Valve Code	PSV-BB-1-C10D	PSV-BB-1-C10E	PSV-BB-1-C10F	PSV-BB-1-C10G
Specs	B4 B9 B10	B4 B9 B10	B4 B9 B10	B4 B9 B10
1. Valve Type	Conventional	Conventional	Conventional	Conventional
2. Orifice Size	Orifice D (A=0.110 in ²)	Orifice E (0.196 in ²)	Orifice F (0.307 in ²)	Orifice G (0.503 in ²)
3. Valve Specification Level (VSL)	VSL-1	VSL-1	VSL-1	VSL-1
4. Standard	API 520	API 520	API 520	API 520
5. Inlet/Outlet Size Range (NPS)	1" x 2"	1" x 2"	1 ½" x 2"	1 ½" x 3"
6. Inlet/Outlet end connection	ASME B16.5, RF x ASME B16.5, RF	ASME B16.5, RF x ASME B16.5, RF	ASME B16.5, RF x ASME B16.5, RF	ASME B16.5, RF x ASME B16.5, RF
7. Inlet/Outlet pressure class	150 x 150	150 x 150	150 x 150	150 x 150
8. Temperature	0°C to 240°C	0°C to 240°C	0°C to 240°C	0°C to 240°C
9. Material Class	Carbon Steel	Carbon Steel	Carbon Steel	Carbon Steel
10. Body and bonnet Material	ASTM A216 Gr WCB	ASTM A216 Gr WCB	ASTM A216 Gr WCB	ASTM A216 Gr WCB
11. Disc Material	Martensitic SS 400 Series	Martensitic SS 400 Series	Martensitic SS 400 Series	Martensitic SS 400 Series
12. Nozzle Material	AISI 316	AISI 316	AISI 316	AISI 316
13. Guide Material	AISI 316	AISI 316	AISI 316	AISI 316
14. Spindle Material	Martensitic SS 400 Series	Martensitic SS 400 Series	Martensitic SS 400 Series	Martensitic SS 400 Series
15. Spring Material	UNS N07750	UNS N07750	UNS N07750	UNS N07750
16. Bellow Material	Not applicable	Not applicable	Not applicable	Not applicable
17. Valve Testing	API 527	API 527	API 527	API 527
18. Notes	Not Applicable	Not Applicable	Not Applicable	Not Applicable

Valve Code	PSV-BB-1-C10H	PSV-BB-1-C10J	PSV-BB-1-C10K	PSV-BB-1-C10L
Specs	B4 B9 B10	B4 B9 B10	B4 B9 B10	B4 B9 B10
1. Valve Type	Conventional	Conventional	Conventional	Conventional
2. Orifice Size	Orifice H (0.785 in ²)	Orifice J (1.287 in ²)	Orifice K (1.838 in ²)	Orifice L (2.853 in ²)
3. Valve Specification Level (VSL)	VSL-1	VSL-1	VSL-1	VSL-1
4. Standard	API 520	API 520	API 520	API 520
5. Inlet/Outlet Size Range (NPS)	1 ½" x 3"	2" x 3"	3" x 4"	3" x 4"
6. Inlet/Outlet end connection	ASME B16.5, RF x ASME B16.5, RF	ASME B16.5, RF x ASME B16.5, RF	ASME B16.5, RF x ASME B16.5, RF	ASME B16.5, RF x ASME B16.5, RF
7. Inlet/Outlet pressure class	150 x 150	150 x 150	150 x 150	150 x 150
8. Temperature	0°C to 240°C	0°C to 240°C	0°C to 240°C	0°C to 240°C
9. Material Class	Carbon Steel	Carbon Steel	Carbon Steel	Carbon Steel
10. Body and bonnet Material	ASTM A216 Gr WCB	ASTM A216 Gr WCB	ASTM A216 Gr WCB	ASTM A216 Gr WCB
11. Disc Material	Martensitic SS 400 Series	Martensitic SS 400 Series	Martensitic SS 400 Series	Martensitic SS 400 Series
12. Nozzle Material	AISI 316	AISI 316	AISI 316	AISI 316
13. Guide Material	AISI 316	AISI 316	AISI 316	AISI 316
14. Spindle Material	Martensitic SS 400 Series	Martensitic SS 400 Series	Martensitic SS 400 Series	Martensitic SS 400 Series
15. Spring Material	UNS N07750	UNS N07750	UNS N07750	UNS N07750
16. Bellow Material	Not applicable	Not applicable	Not applicable	Not applicable
17. Valve Testing	API 527	API 527	API 527	API 527
18. Notes	Not Applicable	Not Applicable	Not Applicable	Not Applicable

Valve Code	PSV-BB-1-C10M	PSV-BB-1-C10N	PSV-BB-1-C10P	PSV-BB-1-C10Q
Specs	B4 B9 B10	B4 B9 B10	B4 B9 B10	B4 B9 B10
1. Valve Type	Conventional	Conventional	Conventional	Conventional
2. Orifice Size	Orifice M (3.60 in ²)	Orifice N (4.34 in ²)	Orifice P (6.38 in ²)	Orifice Q (11.05 in ²)
3. Valve Specification Level (VSL)	VSL-1	VSL-1	VSL-1	VSL-1
4. Standard	API 520	API 520	API 520	API 520
5. Inlet/Outlet Size Range (NPS)	4" x 6"	4" x 6"	4" x 6"	6" x 8"
6. Inlet/Outlet end connection	ASME B16.5, RF x ASME B16.5, RF	ASME B16.5, RF x ASME B16.5, RF	ASME B16.5, RF x ASME B16.5, RF	ASME B16.5, RF x ASME B16.5, RF
7. Inlet/Outlet pressure class	150 x 150	150 x 150	150 x 150	150 x 150
8. Temperature	0°C to 240°C	0°C to 240°C	0°C to 240°C	0°C to 240°C
9. Material Class	Carbon Steel	Carbon Steel	Carbon Steel	Carbon Steel
10. Body and bonnet Material	ASTM A216 Gr WCB	ASTM A216 Gr WCB	ASTM A216 Gr WCB	ASTM A216 Gr WCB
11. Disc Material	Martensitic SS 400 Series	Martensitic SS 400 Series	Martensitic SS 400 Series	Martensitic SS 400 Series
12. Nozzle Material	AISI 316	AISI 316	AISI 316	AISI 316
13. Guide Material	AISI 316	AISI 316	AISI 316	AISI 316
14. Spindle Material	Martensitic SS 400 Series	Martensitic SS 400 Series	Martensitic SS 400 Series	Martensitic SS 400 Series
15. Spring Material	UNS N07750	UNS N07750	UNS N07750	UNS N07750
16. Bellow Material	Not applicable	Not applicable	Not applicable	Not applicable
17. Valve Testing	API 527	API 527	API 527	API 527
18. Notes	Not Applicable	Not Applicable	Not Applicable	Not Applicable

Valve Code	PSV-BB-1-C10R	PSV-BB-1-C10T	PSV-BB-1-C11D	PSV-BB-1-C11E
Specs	B4 B9 B10	B4 B9 B10	B4 B9 B10	B4 B9 B10
1. Valve Type	Conventional	Conventional	Balanced	Balanced
2. Orifice Size	Orifice R (16.00 in ²)	Orifice T (26.00 in ²)	Orifice D (A=0.110 in ²)	Orifice E (0.196 in ²)
3. Valve Specification Level (VSL)	VSL-1	VSL-1	VSL-1	VSL-1
4. Standard	API 520	API 520	API 520	API 520
5. Inlet/Outlet Size Range (NPS)	6" x 8"	8" x 10"	1" x 2"	1" x 2"
6. Inlet/Outlet end connection	ASME B16.5, RF x ASME B16.5, RF	ASME B16.5, RF x ASME B16.5, RF	ASME B16.5, RF x ASME B16.5, RF	ASME B16.5, RF x ASME B16.5, RF
7. Inlet/Outlet pressure class	150 x 150	150 x 150	150 x 150	150 x 150
8. Temperature	0°C to 240°C	0°C to 240°C	0°C to 240°C	0°C to 240°C
9. Material Class	Carbon Steel	Carbon Steel	Carbon Steel	Carbon Steel
10. Body and bonnet Material	ASTM A216 Gr WCB	ASTM A216 Gr WCB	ASTM A216 Gr WCB	ASTM A216 Gr WCB
11. Disc Material	Martensitic SS 400 Series	Martensitic SS 400 Series	Martensitic SS 400 Series	Martensitic SS 400 Series
12. Nozzle Material	AISI 316	AISI 316	AISI 316	AISI 316
13. Guide Material	AISI 316	AISI 316	AISI 316	AISI 316
14. Spindle Material	Martensitic SS 400 Series	Martensitic SS 400 Series	Martensitic SS 400 Series	Martensitic SS 400 Series
15. Spring Material	UNS N07750	UNS N07750	UNS N07750	UNS N07750
16. Bellow Material	Not applicable	Not applicable	UNS N06625	UNS N06625
17. Valve Testing	API 527	API 527	API 527	API 527
18. Notes	Not Applicable	Not Applicable	Not Applicable	Not Applicable

Valve Code	PSV-BB-1-C11F	PSV-BB-1-C11G	PSV-BB-1-C11H	PSV-BB-1-C11J
Specs	B4 B9 B10	B4 B9 B10	B4 B9 B10	B4 B9 B10
1. Valve Type	Balanced	Balanced	Balanced	Balanced
2. Orifice Size	Orifice F (0.307 in ²)	Orifice G (0.503 in ²)	Orifice H (0.785 in ²)	Orifice J (1.287 in ²)
3. Valve Specification Level (VSL)	VSL-1	VSL-1	VSL-1	VSL-1
4. Standard	API 520	API 520	API 520	API 520
5. Inlet/Outlet Size Range (NPS)	1 ½" x 2"	1 ½" x 3"	1 ½" x 3"	2" x 3"
6. Inlet/Outlet end connection	ASME B16.5, RF x ASME B16.5, RF	ASME B16.5, RF x ASME B16.5, RF	ASME B16.5, RF x ASME B16.5, RF	ASME B16.5, RF x ASME B16.5, RF
7. Inlet/Outlet pressure class	150 x 150	150 x 150	150 x 150	150 x 150
8. Temperature	0°C to 240°C	0°C to 240°C	0°C to 240°C	0°C to 240°C
9. Material Class	Carbon Steel	Carbon Steel	Carbon Steel	Carbon Steel
10. Body and bonnet Material	ASTM A216 Gr WCB	ASTM A216 Gr WCB	ASTM A216 Gr WCB	ASTM A216 Gr WCB
11. Disc Material	Martensitic SS 400 Series	Martensitic SS 400 Series	Martensitic SS 400 Series	Martensitic SS 400 Series
12. Nozzle Material	AISI 316	AISI 316	AISI 316	AISI 316
13. Guide Material	AISI 316	AISI 316	AISI 316	AISI 316
14. Spindle Material	Martensitic SS 400 Series	Martensitic SS 400 Series	Martensitic SS 400 Series	Martensitic SS 400 Series
15. Spring Material	UNS N07750	UNS N07750	UNS N07750	UNS N07750
16. Bellow Material	UNS N06625	UNS N06625	UNS N06625	UNS N06625
17. Valve Testing	API 527	API 527	API 527	API 527
18. Notes	Not Applicable	Not Applicable	Not Applicable	Not Applicable

Valve Code	PSV-BB-1-C11K	PSV-BB-1-C11L	PSV-BB-1-C11M	PSV-BB-1-C11N
Specs	B4 B9 B10	B4 B9 B10	B4 B9 B10	B4 B9 B10
1. Valve Type	Balanced	Balanced	Balanced	Balanced
2. Orifice Size	Orifice K (1.838 in ²)	Orifice L (2.853 in ²)	Orifice M (3.60 in ²)	Orifice N (4.34 in ²)
3. Valve Specification Level (VSL)	VSL-1	VSL-1	VSL-1	VSL-1
4. Standard	API 520	API 520	API 520	API 520
5. Inlet/Outlet Size Range (NPS)	3" x 4"	3" x 4"	4" x 6"	4" x 6"
6. Inlet/Outlet end connection	ASME B16.5, RF x ASME B16.5, RF	ASME B16.5, RF x ASME B16.5, RF	ASME B16.5, RF x ASME B16.5, RF	ASME B16.5, RF x ASME B16.5, RF
7. Inlet/Outlet pressure class	150 x 150	150 x 150	150 x 150	150 x 150
8. Temperature	0°C to 240°C	0°C to 240°C	0°C to 240°C	0°C to 240°C
9. Material Class	Carbon Steel	Carbon Steel	Carbon Steel	Carbon Steel
10. Body and bonnet Material	ASTM A216 Gr WCB	ASTM A216 Gr WCB	ASTM A216 Gr WCB	ASTM A216 Gr WCB
11. Disc Material	Martensitic SS 400 Series	Martensitic SS 400 Series	Martensitic SS 400 Series	Martensitic SS 400 Series
12. Nozzle Material	AISI 316	AISI 316	AISI 316	AISI 316
13. Guide Material	AISI 316	AISI 316	AISI 316	AISI 316
14. Spindle Material	Martensitic SS 400 Series	Martensitic SS 400 Series	Martensitic SS 400 Series	Martensitic SS 400 Series
15. Spring Material	UNS N07750	UNS N07750	UNS N07750	UNS N07750
16. Bellow Material	UNS N06625	UNS N06625	UNS N06625	UNS N06625
17. Valve Testing	API 527	API 527	API 527	API 527
18. Notes	Not Applicable	Not Applicable	Not Applicable	Not Applicable

Valve Code	PSV-BB-1-C11P	PSV-BB-1-C11Q	PSV-BB-1-C11R	PSV-BB-1-C11T
Specs	B4 B9 B10	B4 B9 B10	B4 B9 B10	B4 B9 B10
1. Valve Type	Balanced	Balanced	Balanced	Balanced
2. Orifice Size	Orifice P (6.38 in ²)	Orifice Q (11.05 in ²)	Orifice R (16.00 in ²)	Orifice T (26.00 in ²)
3. Valve Specification Level (VSL)	VSL-1	VSL-1	VSL-1	VSL-1
4. Standard	API 520	API 520	API 520	API 520
5. Inlet/Outlet Size Range (NPS)	4" x 6"	6" x 8"	6" x 8"	8" x 10"
6. Inlet/Outlet end connection	ASME B16.5, RF x ASME B16.5, RF	ASME B16.5, RF x ASME B16.5, RF	ASME B16.5, RF x ASME B16.5, RF	ASME B16.5, RF x ASME B16.5, RF
7. Inlet/Outlet pressure class	150 x 150	150 x 150	150 x 150	150 x 150
8. Temperature	0°C to 240°C	0°C to 240°C	0°C to 240°C	0°C to 240°C
9. Material Class	Carbon Steel	Carbon Steel	Carbon Steel	Carbon Steel
10. Body and bonnet Material	ASTM A216 Gr WCB	ASTM A216 Gr WCB	ASTM A216 Gr WCB	ASTM A216 Gr WCB
11. Disc Material	Martensitic SS 400 Series	Martensitic SS 400 Series	Martensitic SS 400 Series	Martensitic SS 400 Series
12. Nozzle Material	AISI 316	AISI 316	AISI 316	AISI 316
13. Guide Material	AISI 316	AISI 316	AISI 316	AISI 316
14. Spindle Material	Martensitic SS 400 Series	Martensitic SS 400 Series	Martensitic SS 400 Series	Martensitic SS 400 Series
15. Spring Material	UNS N07750	UNS N07750	UNS N07750	UNS N07750
16. Bellow Material	UNS N06625	UNS N06625	UNS N06625	UNS N06625
17. Valve Testing	API 527	API 527	API 527	API 527
18. Notes	Not Applicable	Not Applicable	Not Applicable	Not Applicable

Valve Code	PSV-BB-1-C20D	PSV-BB-1-C20E	PSV-BB-1-C20F	PSV-BB-1-C20G
Specs	B6 B9 B10 B19	B6 B9 B10 B19	B6 B9 B10 B19	B6 B9 B10 B19
1. Valve Type	Conventional	Conventional	Conventional	Conventional
2. Orifice Size	Orifice D (A=0.110 in ²)	Orifice E (0.196 in ²)	Orifice F (0.307 in ²)	Orifice G (0.503 in ²)
3. Valve Specification Level (VSL)	VSL-1	VSL-1	VSL-1	VSL-1
4. Standard	API 520	API 520	API 520	API 520
5. Inlet/Outlet Size Range (NPS)	1" x 2"	1" x 2"	1 ½" x 2"	1 ½" x 3"
6. Inlet/Outlet end connection	ASME B16.5, RF x ASME B16.5, RF	ASME B16.5, RF x ASME B16.5, RF	ASME B16.5, RF x ASME B16.5, RF	ASME B16.5, RF x ASME B16.5, RF
7. Inlet/Outlet pressure class	150 x 150	150 x 150	150 x 150	150 x 150
8. Temperature	-46°C to 240°C	-46°C to 240°C	-46°C to 240°C	-46°C to 240°C
9. Material Class	Carbon Steel	Carbon Steel	Carbon Steel	Carbon Steel
10. Body and bonnet Material	ASTM A352 Gr LCB	ASTM A352 Gr LCB	ASTM A352 Gr LCB	ASTM A352 Gr LCB
11. Disc Material	AISI 316 + Stellite	AISI 316 + Stellite	AISI 316 + Stellite	AISI 316 + Stellite
12. Nozzle Material	AISI 316	AISI 316	AISI 316	AISI 316
13. Guide Material	AISI 316	AISI 316	AISI 316	AISI 316
14. Spindle Material	Martensitic SS 400 Series	Martensitic SS 400 Series	Martensitic SS 400 Series	Martensitic SS 400 Series
15. Spring Material	UNS N07750	UNS N07750	UNS N07750	UNS N07750
16. Bellow Material	Not applicable	Not applicable	Not applicable	Not applicable
17. Valve Testing	API 527	API 527	API 527	API 527
18. Notes	Not Applicable	Not Applicable	Not Applicable	Not Applicable

Valve Code	PSV-BB-1-C20H	PSV-BB-1-C20J	PSV-BB-1-C20K	PSV-BB-1-C20L
Specs	B6 B9 B10 B19	B6 B9 B10 B19	B6 B9 B10 B19	B6 B9 B10 B19
1. Valve Type	Conventional	Conventional	Conventional	Conventional
2. Orifice Size	Orifice H (0.785 in ²)	Orifice J (1.287 in ²)	Orifice K (1.838 in ²)	Orifice L (2.853 in ²)
3. Valve Specification Level (VSL)	VSL-1	VSL-1	VSL-1	VSL-1
4. Standard	API 520	API 520	API 520	API 520
5. Inlet/Outlet Size Range (NPS)	1 ½" x 3"	2" x 3"	3" x 4"	3" x 4"
6. Inlet/Outlet end connection	ASME B16.5, RF x ASME B16.5, RF	ASME B16.5, RF x ASME B16.5, RF	ASME B16.5, RF x ASME B16.5, RF	ASME B16.5, RF x ASME B16.5, RF
7. Inlet/Outlet pressure class	150 x 150	150 x 150	150 x 150	150 x 150
8. Temperature	-46°C to 240°C	-46°C to 240°C	-46°C to 240°C	-46°C to 240°C
9. Material Class	Carbon Steel	Carbon Steel	Carbon Steel	Carbon Steel
10. Body and bonnet Material	ASTM A352 Gr LCB	ASTM A352 Gr LCB	ASTM A352 Gr LCB	ASTM A352 Gr LCB
11. Disc Material	AISI 316 + Stellite	AISI 316 + Stellite	AISI 316 + Stellite	AISI 316 + Stellite
12. Nozzle Material	AISI 316	AISI 316	AISI 316	AISI 316
13. Guide Material	AISI 316	AISI 316	AISI 316	AISI 316
14. Spindle Material	Martensitic SS 400 Series	Martensitic SS 400 Series	Martensitic SS 400 Series	Martensitic SS 400 Series
15. Spring Material	UNS N07750	UNS N07750	UNS N07750	UNS N07750
16. Bellow Material	Not applicable	Not applicable	Not applicable	Not applicable
17. Valve Testing	API 527	API 527	API 527	API 527
18. Notes	Not Applicable	Not Applicable	Not Applicable	Not Applicable

Valve Code	PSV-BB-1-C20M	PSV-BB-1-C20N	PSV-BB-1-C20P	PSV-BB-1-C20Q
Specs	B6 B9 B10 B19	B6 B9 B10 B19	B6 B9 B10 B19	B6 B9 B10 B19
1. Valve Type	Conventional	Conventional	Conventional	Conventional
2. Orifice Size	Orifice M (3.60 in ²)	Orifice N (4.34 in ²)	Orifice P (6.38 in ²)	Orifice Q (11.05 in ²)
3. Valve Specification Level (VSL)	VSL-1	VSL-1	VSL-1	VSL-1
4. Standard	API 520	API 520	API 520	API 520
5. Inlet/Outlet Size Range (NPS)	4" x 6"	4" x 6"	4" x 6"	6" x 8"
6. Inlet/Outlet end connection	ASME B16.5, RF x ASME B16.5, RF	ASME B16.5, RF x ASME B16.5, RF	ASME B16.5, RF x ASME B16.5, RF	ASME B16.5, RF x ASME B16.5, RF
7. Inlet/Outlet pressure class	150 x 150	150 x 150	150 x 150	150 x 150
8. Temperature	-46°C to 240°C	-46°C to 240°C	-46°C to 240°C	-46°C to 240°C
9. Material Class	Carbon Steel	Carbon Steel	Carbon Steel	Carbon Steel
10. Body and bonnet Material	ASTM A352 Gr LCB	ASTM A352 Gr LCB	ASTM A352 Gr LCB	ASTM A352 Gr LCB
11. Disc Material	AISI 316 + Stellite	AISI 316 + Stellite	AISI 316 + Stellite	AISI 316 + Stellite
12. Nozzle Material	AISI 316	AISI 316	AISI 316	AISI 316
13. Guide Material	AISI 316	AISI 316	AISI 316	AISI 316
14. Spindle Material	Martensitic SS 400 Series	Martensitic SS 400 Series	Martensitic SS 400 Series	Martensitic SS 400 Series
15. Spring Material	UNS N07750	UNS N07750	UNS N07750	UNS N07750
16. Bellow Material	Not applicable	Not applicable	Not applicable	Not applicable
17. Valve Testing	API 527	API 527	API 527	API 527
18. Notes	Not Applicable	Not Applicable	Not Applicable	Not Applicable

Valve Code	PSV-BB-1-C20R	PSV-BB-1-C20T	PSV-BB-1-C21D	PSV-BB-1-C21E
Specs	B6 B9 B10 B19	B6 B9 B10 B19	B6 B9 B10 B19	B6 B9 B10 B19
1. Valve Type	Conventional	Conventional	Balanced	Balanced
2. Orifice Size	Orifice R (16.00 in ²)	Orifice T (26.00 in ²)	Orifice D (A=0.110 in ²)	Orifice E (0.196 in ²)
3. Valve Specification Level (VSL)	VSL-1	VSL-1	VSL-1	VSL-1
4. Standard	API 520	API 520	API 520	API 520
5. Inlet/Outlet Size Range (NPS)	6" x 8"	8" x 10"	1" x 2"	1" x 2"
6. Inlet/Outlet end connection	ASME B16.5, RF x ASME B16.5, RF	ASME B16.5, RF x ASME B16.5, RF	ASME B16.5, RF x ASME B16.5, RF	ASME B16.5, RF x ASME B16.5, RF
7. Inlet/Outlet pressure class	150 x 150	150 x 150	150 x 150	150 x 150
8. Temperature	-46°C to 240°C	-46°C to 240°C	-46°C to 240°C	-46°C to 240°C
9. Material Class	Carbon Steel	Carbon Steel	Carbon Steel	Carbon Steel
10. Body and bonnet Material	ASTM A352 Gr LCB	ASTM A352 Gr LCB	ASTM A352 Gr LCB	ASTM A352 Gr LCB
11. Disc Material	AISI 316 + Stellite	AISI 316 + Stellite	AISI 316 + Stellite	AISI 316 + Stellite
12. Nozzle Material	AISI 316	AISI 316	AISI 316	AISI 316
13. Guide Material	AISI 316	AISI 316	AISI 316	AISI 316
14. Spindle Material	Martensitic SS 400 Series	Martensitic SS 400 Series	Martensitic SS 400 Series	Martensitic SS 400 Series
15. Spring Material	UNS N07750	UNS N07750	UNS N07750	UNS N07750
16. Bellow Material	Not applicable	Not applicable	UNS N06625	UNS N06625
17. Valve Testing	API 527	API 527	API 527	API 527
18. Notes	Not Applicable	Not Applicable	Not Applicable	Not Applicable

Valve Code	PSV-BB-1-C21F	PSV-BB-1-C21G	PSV-BB-1-C21H	PSV-BB-1-C21J
Specs	B6 B9 B10 B19	B6 B9 B10 B19	B6 B9 B10 B19	B6 B9 B10 B19
1. Valve Type	Balanced	Balanced	Balanced	Balanced
2. Orifice Size	Orifice F (0.307 in ²)	Orifice G (0.503 in ²)	Orifice H (0.785 in ²)	Orifice J (1.287 in ²)
3. Valve Specification Level (VSL)	VSL-1	VSL-1	VSL-1	VSL-1
4. Standard	API 520	API 520	API 520	API 520
5. Inlet/Outlet Size Range (NPS)	1 ½" x 2"	1 ½" x 3"	1 ½" x 3"	2" x 3"
6. Inlet/Outlet end connection	ASME B16.5, RF x ASME B16.5, RF	ASME B16.5, RF x ASME B16.5, RF	ASME B16.5, RF x ASME B16.5, RF	ASME B16.5, RF x ASME B16.5, RF
7. Inlet/Outlet pressure class	150 x 150	150 x 150	150 x 150	150 x 150
8. Temperature	-46°C to 240°C	-46°C to 240°C	-46°C to 240°C	-46°C to 240°C
9. Material Class	Carbon Steel	Carbon Steel	Carbon Steel	Carbon Steel
10. Body and bonnet Material	ASTM A352 Gr LCB	ASTM A352 Gr LCB	ASTM A352 Gr LCB	ASTM A352 Gr LCB
11. Disc Material	AISI 316 + Stellite	AISI 316 + Stellite	AISI 316 + Stellite	AISI 316 + Stellite
12. Nozzle Material	AISI 316	AISI 316	AISI 316	AISI 316
13. Guide Material	AISI 316	AISI 316	AISI 316	AISI 316
14. Spindle Material	Martensitic SS 400 Series	Martensitic SS 400 Series	Martensitic SS 400 Series	Martensitic SS 400 Series
15. Spring Material	UNS N07750	UNS N07750	UNS N07750	UNS N07750
16. Bellow Material	UNS N06625	UNS N06625	UNS N06625	UNS N06625
17. Valve Testing	API 527	API 527	API 527	API 527
18. Notes	Not Applicable	Not Applicable	Not Applicable	Not Applicable

Valve Code	PSV-BB-1-C21K	PSV-BB-1-C21L	PSV-BB-1-C21M	PSV-BB-1-C21N
Specs	B6 B9 B10 B19	B6 B9 B10 B19	B6 B9 B10 B19	B6 B9 B10 B19
1. Valve Type	Balanced	Balanced	Balanced	Balanced
2. Orifice Size	Orifice K (1.838 in ²)	Orifice L (2.853 in ²)	Orifice M (3.60 in ²)	Orifice N (4.34 in ²)
3. Valve Specification Level (VSL)	VSL-1	VSL-1	VSL-1	VSL-1
4. Standard	API 520	API 520	API 520	API 520
5. Inlet/Outlet Size Range (NPS)	3" x 4"	3" x 4"	4" x 6"	4" x 6"
6. Inlet/Outlet end connection	ASME B16.5, RF x ASME B16.5, RF	ASME B16.5, RF x ASME B16.5, RF	ASME B16.5, RF x ASME B16.5, RF	ASME B16.5, RF x ASME B16.5, RF
7. Inlet/Outlet pressure class	150 x 150	150 x 150	150 x 150	150 x 150
8. Temperature	-46°C to 240°C	-46°C to 240°C	-46°C to 240°C	-46°C to 240°C
9. Material Class	Carbon Steel	Carbon Steel	Carbon Steel	Carbon Steel
10. Body and bonnet Material	ASTM A352 Gr LCB	ASTM A352 Gr LCB	ASTM A352 Gr LCB	ASTM A352 Gr LCB
11. Disc Material	AISI 316 + Stellite	AISI 316 + Stellite	AISI 316 + Stellite	AISI 316 + Stellite
12. Nozzle Material	AISI 316	AISI 316	AISI 316	AISI 316
13. Guide Material	AISI 316	AISI 316	AISI 316	AISI 316
14. Spindle Material	Martensitic SS 400 Series	Martensitic SS 400 Series	Martensitic SS 400 Series	Martensitic SS 400 Series
15. Spring Material	UNS N07750	UNS N07750	UNS N07750	UNS N07750
16. Bellow Material	UNS N06625	UNS N06625	UNS N06625	UNS N06625
17. Valve Testing	API 527	API 527	API 527	API 527
18. Notes	Not Applicable	Not Applicable	Not Applicable	Not Applicable

Valve Code	PSV-BB-1-C21P	PSV-BB-1-C21Q	PSV-BB-1-C21R	PSV-BB-1-C21T
Specs	B6 B9 B10 B19	B6 B9 B10 B19	B6 B9 B10 B19	B6 B9 B10 B19
1. Valve Type	Balanced	Balanced	Balanced	Balanced
2. Orifice Size	Orifice P (6.38 in ²)	Orifice Q (11.05 in ²)	Orifice R (16.00 in ²)	Orifice T (26.00 in ²)
3. Valve Specification Level (VSL)	VSL-1	VSL-1	VSL-1	VSL-1
4. Standard	API 520	API 520	API 520	API 520
5. Inlet/Outlet Size Range (NPS)	4" x 6"	6" x 8"	6" x 8"	8" x 10"
6. Inlet/Outlet end connection	ASME B16.5, RF x ASME B16.5, RF	ASME B16.5, RF x ASME B16.5, RF	ASME B16.5, RF x ASME B16.5, RF	ASME B16.5, RF x ASME B16.5, RF
7. Inlet/Outlet pressure class	150 x 150	150 x 150	150 x 150	150 x 150
8. Temperature	-46°C to 240°C	-46°C to 240°C	-46°C to 240°C	-46°C to 240°C
9. Material Class	Carbon Steel	Carbon Steel	Carbon Steel	Carbon Steel
10. Body and bonnet Material	ASTM A352 Gr LCB	ASTM A352 Gr LCB	ASTM A352 Gr LCB	ASTM A352 Gr LCB
11. Disc Material	AISI 316 + Stellite	AISI 316 + Stellite	AISI 316 + Stellite	AISI 316 + Stellite
12. Nozzle Material	AISI 316	AISI 316	AISI 316	AISI 316
13. Guide Material	AISI 316	AISI 316	AISI 316	AISI 316
14. Spindle Material	Martensitic SS 400 Series	Martensitic SS 400 Series	Martensitic SS 400 Series	Martensitic SS 400 Series
15. Spring Material	UNS N07750	UNS N07750	UNS N07750	UNS N07750
16. Bellow Material	UNS N06625	UNS N06625	UNS N06625	UNS N06625
17. Valve Testing	API 527	API 527	API 527	API 527
18. Notes	Not Applicable	Not Applicable	Not Applicable	Not Applicable

Valve Code	PSV-BB-1-D21D	PSV-BB-1-D21E	PSV-BB-1-D21F	PSV-BB-1-D21G
Specs	B16	B16	B16	B16
1. Valve Type	Balanced	Balanced	Balanced	Balanced
2. Orifice Size	Orifice D (A=0.110 in ²)	Orifice E (0.196 in ²)	Orifice F (0.307 in ²)	Orifice G (0.503 in ²)
3. Valve Specification Level (VSL)	VSL-1	VSL-1	VSL-1	VSL-1
4. Standard	API 520	API 520	API 520	API 520
5. Inlet/Outlet Size Range (NPS)	1" x 2"	1" x 2"	1 ½" x 2"	1 ½" x 3"
6. Inlet/Outlet end connection	ASME B16.5, RF x ASME B16.5, RF	ASME B16.5, RF x ASME B16.5, RF	ASME B16.5, RF x ASME B16.5, RF	ASME B16.5, RF x ASME B16.5, RF
7. Inlet/Outlet pressure class	150 x 150	150 x 150	150 x 150	150 x 150
8. Temperature	-50°C to 100°C	-50°C to 100°C	-50°C to 100°C	-50°C to 100°C
9. Material Class	Duplex Steel	Duplex Steel	Duplex Steel	Duplex Steel
10. Body and bonnet Material	ASTM A995 Gr 4a	ASTM A995 Gr 4a	ASTM A995 Gr 4a	ASTM A995 Gr 4a
11. Disc Material	ASTM A479 (UNS S31803)	ASTM A479 (UNS S31803)	ASTM A479 (UNS S31803)	ASTM A479 (UNS S31803)
12. Nozzle Material	ASTM A479 (UNS S31803)	ASTM A479 (UNS S31803)	ASTM A479 (UNS S31803)	ASTM A479 (UNS S31803)
13. Guide Material	AISI 316	AISI 316	AISI 316	AISI 316
14. Spindle Material	Martensitic SS 400 Series	Martensitic SS 400 Series	Martensitic SS 400 Series	Martensitic SS 400 Series
15. Spring Material	UNS N07750	UNS N07750	UNS N07750	UNS N07750
16. Bellow Material	UNS N06625	UNS N06625	UNS N06625	UNS N06625
17. Valve Testing	API 527	API 527	API 527	API 527
18. Notes	Not Applicable	Not Applicable	Not Applicable	Not Applicable

Valve Code	PSV-BB-1-D21H	PSV-BB-1-D21J	PSV-BB-1-D21K	PSV-BB-1-D21L
Specs	B16	B16	B16	B16
1. Valve Type	Balanced	Balanced	Balanced	Balanced
2. Orifice Size	Orifice H (0.785 in ²)	Orifice J (1.287 in ²)	Orifice K (1.838 in ²)	Orifice L (2.853 in ²)
3. Valve Specification Level (VSL)	VSL-1	VSL-1	VSL-1	VSL-1
4. Standard	API 520	API 520	API 520	API 520
5. Inlet/Outlet Size Range (NPS)	1 ½" x 3"	2" x 3"	3" x 4"	3" x 4"
6. Inlet/Outlet end connection	ASME B16.5, RF x ASME B16.5, RF	ASME B16.5, RF x ASME B16.5, RF	ASME B16.5, RF x ASME B16.5, RF	ASME B16.5, RF x ASME B16.5, RF
7. Inlet/Outlet pressure class	150 x 150	150 x 150	150 x 150	150 x 150
8. Temperature	-50°C to 100°C	-50°C to 100°C	-50°C to 100°C	-50°C to 100°C
9. Material Class	Duplex Steel	Duplex Steel	Duplex Steel	Duplex Steel
10. Body and bonnet Material	ASTM A995 Gr 4a	ASTM A995 Gr 4a	ASTM A995 Gr 4a	ASTM A995 Gr 4a
11. Disc Material	ASTM A479 (UNS S31803)	ASTM A479 (UNS S31803)	ASTM A479 (UNS S31803)	ASTM A479 (UNS S31803)
12. Nozzle Material	ASTM A479 (UNS S31803)	ASTM A479 (UNS S31803)	ASTM A479 (UNS S31803)	ASTM A479 (UNS S31803)
13. Guide Material	AISI 316	AISI 316	AISI 316	AISI 316
14. Spindle Material	Martensitic SS 400 Series	Martensitic SS 400 Series	Martensitic SS 400 Series	Martensitic SS 400 Series
15. Spring Material	UNS N07750	UNS N07750	UNS N07750	UNS N07750
16. Bellow Material	UNS N06625	UNS N06625	UNS N06625	UNS N06625
17. Valve Testing	API 527	API 527	API 527	API 527
18. Notes	Not Applicable	Not Applicable	Not Applicable	Not Applicable

Valve Code	PSV-BB-1-D21M	PSV-BB-1-D21N	PSV-BB-1-D21P	PSV-BB-1-D21Q
Specs	B16	B16	B16	B16
1. Valve Type	Balanced	Balanced	Balanced	Balanced
2. Orifice Size	Orifice M (3.60 in ²)	Orifice N (4.34 in ²)	Orifice P (6.38 in ²)	Orifice Q (11.05 in ²)
3. Valve Specification Level (VSL)	VSL-1	VSL-1	VSL-1	VSL-1
4. Standard	API 520	API 520	API 520	API 520
5. Inlet/Outlet Size Range (NPS)	4" x 6"	4" x 6"	4" x 6"	6" x 8"
6. Inlet/Outlet end connection	ASME B16.5, RF x ASME B16.5, RF	ASME B16.5, RF x ASME B16.5, RF	ASME B16.5, RF x ASME B16.5, RF	ASME B16.5, RF x ASME B16.5, RF
7. Inlet/Outlet pressure class	150 x 150	150 x 150	150 x 150	150 x 150
8. Temperature	-50°C to 100°C	-50°C to 100°C	-50°C to 100°C	-50°C to 100°C
9. Material Class	Duplex Steel	Duplex Steel	Duplex Steel	Duplex Steel
10. Body and bonnet Material	ASTM A995 Gr 4a	ASTM A995 Gr 4a	ASTM A995 Gr 4a	ASTM A995 Gr 4a
11. Disc Material	ASTM A479 (UNS S31803)	ASTM A479 (UNS S31803)	ASTM A479 (UNS S31803)	ASTM A479 (UNS S31803)
12. Nozzle Material	ASTM A479 (UNS S31803)	ASTM A479 (UNS S31803)	ASTM A479 (UNS S31803)	ASTM A479 (UNS S31803)
13. Guide Material	AISI 316	AISI 316	AISI 316	AISI 316
14. Spindle Material	Martensitic SS 400 Series	Martensitic SS 400 Series	Martensitic SS 400 Series	Martensitic SS 400 Series
15. Spring Material	UNS N07750	UNS N07750	UNS N07750	UNS N07750
16. Bellow Material	UNS N06625	UNS N06625	UNS N06625	UNS N06625
17. Valve Testing	API 527	API 527	API 527	API 527
18. Notes	Not Applicable	Not Applicable	Not Applicable	Not Applicable

Valve Code	PSV-BB-1-D21R	PSV-BB-1-D21T	PSV-BB-1-D31D	PSV-BB-1-D31E
Specs	B16	B16	B12	B12
1. Valve Type	Balanced	Balanced	Balanced	Balanced
2. Orifice Size	Orifice R (16.00 in ²)	Orifice T (26.00 in ²)	Orifice D (A=0.110 in ²)	Orifice E (0.196 in ²)
3. Valve Specification Level (VSL)	VSL-1	VSL-1	VSL-1	VSL-1
4. Standard	API 520	API 520	API 520	API 520
5. Inlet/Outlet Size Range (NPS)	6" x 8"	8" x 10"	1" x 2"	1" x 2"
6. Inlet/Outlet end connection	ASME B16.5, RF x ASME B16.5, RF	ASME B16.5, RF x ASME B16.5, RF	ASME B16.5, RF x ASME B16.5, RF	ASME B16.5, RF x ASME B16.5, RF
7. Inlet/Outlet pressure class	150 x 150	150 x 150	150 x 150	150 x 150
8. Temperature	-50°C to 100°C	-50°C to 100°C	-50°C to 110°C	-50°C to 110°C
9. Material Class	Duplex Steel	Duplex Steel	Duplex Steel	Duplex Steel
10. Body and bonnet Material	ASTM A995 Gr 4a	ASTM A995 Gr 4a	ASTM A995 Gr 6a	ASTM A995 Gr 6a
11. Disc Material	ASTM A479 (UNS S31803)	ASTM A479 (UNS S31803)	ASTM A479 (UNS S32760)	ASTM A479 (UNS S32760)
12. Nozzle Material	ASTM A479 (UNS S31803)	ASTM A479 (UNS S31803)	ASTM A479 (UNS S32760)	ASTM A479 (UNS S32760)
13. Guide Material	AISI 316	AISI 316	AISI 316	AISI 316
14. Spindle Material	Martensitic SS 400 Series	Martensitic SS 400 Series	Martensitic SS 400 Series	Martensitic SS 400 Series
15. Spring Material	UNS N07750	UNS N07750	UNS N07750	UNS N07750
16. Bellow Material	UNS N06625	UNS N06625	UNS N06625	UNS N06625
17. Valve Testing	API 527	API 527	API 527	API 527
18. Notes	Not Applicable	Not Applicable	Not Applicable	Not Applicable

Valve Code	PSV-BB-1-D31F	PSV-BB-1-D31G	PSV-BB-1-D31H	PSV-BB-1-D31J
Specs	B12	B12	B12	B12
1. Valve Type	Balanced	Balanced	Balanced	Balanced
2. Orifice Size	Orifice F (0.307 in ²)	Orifice G (0.503 in ²)	Orifice H (0.785 in ²)	Orifice J (1.287 in ²)
3. Valve Specification Level (VSL)	VSL-1	VSL-1	VSL-1	VSL-1
4. Standard	API 520	API 520	API 520	API 520
5. Inlet/Outlet Size Range (NPS)	1 ½" x 2"	1 ½" x 3"	1 ½" x 3"	2" x 3"
6. Inlet/Outlet end connection	ASME B16.5, RF x ASME B16.5, RF	ASME B16.5, RF x ASME B16.5, RF	ASME B16.5, RF x ASME B16.5, RF	ASME B16.5, RF x ASME B16.5, RF
7. Inlet/Outlet pressure class	150 x 150	150 x 150	150 x 150	150 x 150
8. Temperature	-50°C to 110°C	-50°C to 110°C	-50°C to 110°C	-50°C to 110°C
9. Material Class	Duplex Steel	Duplex Steel	Duplex Steel	Duplex Steel
10. Body and bonnet Material	ASTM A995 Gr 6a	ASTM A995 Gr 6a	ASTM A995 Gr 6a	ASTM A995 Gr 6a
11. Disc Material	ASTM A479 (UNS S32760)	ASTM A479 (UNS S32760)	ASTM A479 (UNS S32760)	ASTM A479 (UNS S32760)
12. Nozzle Material	ASTM A479 (UNS S32760)	ASTM A479 (UNS S32760)	ASTM A479 (UNS S32760)	ASTM A479 (UNS S32760)
13. Guide Material	AISI 316	AISI 316	AISI 316	AISI 316
14. Spindle Material	Martensitic SS 400 Series	Martensitic SS 400 Series	Martensitic SS 400 Series	Martensitic SS 400 Series
15. Spring Material	UNS N07750	UNS N07750	UNS N07750	UNS N07750
16. Bellow Material	UNS N06625	UNS N06625	UNS N06625	UNS N06625
17. Valve Testing	API 527	API 527	API 527	API 527
18. Notes	Not Applicable	Not Applicable	Not Applicable	Not Applicable

Valve Code	PSV-BB-1-D31K	PSV-BB-1-D31L	PSV-BB-1-D31M	PSV-BB-1-D31N
Specs	B12	B12	B12	B12
1. Valve Type	Balanced	Balanced	Balanced	Balanced
2. Orifice Size	Orifice K (1.838 in ²)	Orifice L (2.853 in ²)	Orifice M (3.60 in ²)	Orifice N (4.34 in ²)
3. Valve Specification Level (VSL)	VSL-1	VSL-1	VSL-1	VSL-1
4. Standard	API 520	API 520	API 520	API 520
5. Inlet/Outlet Size Range (NPS)	3" x 4"	3" x 4"	4" x 6"	4" x 6"
6. Inlet/Outlet end connection	ASME B16.5, RF x ASME B16.5, RF	ASME B16.5, RF x ASME B16.5, RF	ASME B16.5, RF x ASME B16.5, RF	ASME B16.5, RF x ASME B16.5, RF
7. Inlet/Outlet pressure class	150 x 150	150 x 150	150 x 150	150 x 150
8. Temperature	-50°C to 110°C	-50°C to 110°C	-50°C to 110°C	-50°C to 110°C
9. Material Class	Duplex Steel	Duplex Steel	Duplex Steel	Duplex Steel
10. Body and bonnet Material	ASTM A995 Gr 6a	ASTM A995 Gr 6a	ASTM A995 Gr 6a	ASTM A995 Gr 6a
11. Disc Material	ASTM A479 (UNS S32760)	ASTM A479 (UNS S32760)	ASTM A479 (UNS S32760)	ASTM A479 (UNS S32760)
12. Nozzle Material	ASTM A479 (UNS S32760)	ASTM A479 (UNS S32760)	ASTM A479 (UNS S32760)	ASTM A479 (UNS S32760)
13. Guide Material	AISI 316	AISI 316	AISI 316	AISI 316
14. Spindle Material	Martensitic SS 400 Series	Martensitic SS 400 Series	Martensitic SS 400 Series	Martensitic SS 400 Series
15. Spring Material	UNS N07750	UNS N07750	UNS N07750	UNS N07750
16. Bellow Material	UNS N06625	UNS N06625	UNS N06625	UNS N06625
17. Valve Testing	API 527	API 527	API 527	API 527
18. Notes	Not Applicable	Not Applicable	Not Applicable	Not Applicable

Valve Code	PSV-BB-1-D31P	PSV-BB-1-D31Q	PSV-BB-1-D31R	PSV-BB-1-D31T
Specs	B12	B12	B12	B12
1. Valve Type	Balanced	Balanced	Balanced	Balanced
2. Orifice Size	Orifice P (6.38 in ²)	Orifice Q (11.05 in ²)	Orifice R (16.00 in ²)	Orifice T (26.00 in ²)
3. Valve Specification Level (VSL)	VSL-1	VSL-1	VSL-1	VSL-1
4. Standard	API 520	API 520	API 520	API 520
5. Inlet/Outlet Size Range (NPS)	4" x 6"	6" x 8"	6" x 8"	8" x 10"
6. Inlet/Outlet end connection	ASME B16.5, RF x ASME B16.5, RF	ASME B16.5, RF x ASME B16.5, RF	ASME B16.5, RF x ASME B16.5, RF	ASME B16.5, RF x ASME B16.5, RF
7. Inlet/Outlet pressure class	150 x 150	150 x 150	150 x 150	150 x 150
8. Temperature	-50°C to 110°C	-50°C to 110°C	-50°C to 110°C	-50°C to 110°C
9. Material Class	Duplex Steel	Duplex Steel	Duplex Steel	Duplex Steel
10. Body and bonnet Material	ASTM A995 Gr 6a	ASTM A995 Gr 6a	ASTM A995 Gr 6a	ASTM A995 Gr 6a
11. Disc Material	ASTM A479 (UNS S32760)	ASTM A479 (UNS S32760)	ASTM A479 (UNS S32760)	ASTM A479 (UNS S32760)
12. Nozzle Material	ASTM A479 (UNS S32760)	ASTM A479 (UNS S32760)	ASTM A479 (UNS S32760)	ASTM A479 (UNS S32760)
13. Guide Material	AISI 316	AISI 316	AISI 316	AISI 316
14. Spindle Material	Martensitic SS 400 Series	Martensitic SS 400 Series	Martensitic SS 400 Series	Martensitic SS 400 Series
15. Spring Material	UNS N07750	UNS N07750	UNS N07750	UNS N07750
16. Bellow Material	UNS N06625	UNS N06625	UNS N06625	UNS N06625
17. Valve Testing	API 527	API 527	API 527	API 527
18. Notes	Not Applicable	Not Applicable	Not Applicable	Not Applicable

Valve Code	PSV-BB-1-N11D	PSV-BB-1-N11E	PSV-BB-1-N11F	PSV-BB-1-N11G
Specs	B30	B30	B30	B30
1. Valve Type	Balanced	Balanced	Balanced	Balanced
2. Orifice Size	Orifice D (A=0.110 in ²)	Orifice E (0.196 in ²)	Orifice F (0.307 in ²)	Orifice G (0.503 in ²)
3. Valve Specification Level (VSL)	VSL-1	VSL-1	VSL-1	VSL-1
4. Standard	API 520	API 520	API 520	API 520
5. Inlet/Outlet Size Range (NPS)	1" x 2"	1" x 2"	1 ½" x 2"	1 ½" x 3"
6. Inlet/Outlet end connection	ASME B16.5, RF x ASME B16.5, RF	ASME B16.5, RF x ASME B16.5, RF	ASME B16.5, RF x ASME B16.5, RF	ASME B16.5, RF x ASME B16.5, RF
7. Inlet/Outlet pressure class	150 x 150	150 x 150	150 x 150	150 x 150
8. Temperature	-100°C to 155°C	-100°C to 155°C	-100°C to 155°C	-100°C to 155°C
9. Material Class	Nickel Alloys	Nickel Alloys	Nickel Alloys	Nickel Alloys
10. Body and bonnet Material	UNS N06625	UNS N06625	UNS N06625	UNS N06625
11. Disc Material	UNS N06625	UNS N06625	UNS N06625	UNS N06625
12. Nozzle Material	ASTM B564 (UNS N06625)	ASTM B564 (UNS N06625)	ASTM B564 (UNS N06625)	ASTM B564 (UNS N06625)
13. Guide Material	AISI 316	AISI 316	AISI 316	AISI 316
14. Spindle Material	Martensitic SS 400 Series	Martensitic SS 400 Series	Martensitic SS 400 Series	Martensitic SS 400 Series
15. Spring Material	UNS N07750	UNS N07750	UNS N07750	UNS N07750
16. Bellow Material	UNS N06625	UNS N06625	UNS N06625	UNS N06625
17. Valve Testing	API 527	API 527	API 527	API 527
18. Notes	Not Applicable	Not Applicable	Not Applicable	Not Applicable

Valve Code	PSV-BB-1-N11H	PSV-BB-1-N11J	PSV-BB-1-N11K	PSV-BB-1-N11L
Specs	B30	B30	B30	B30
1. Valve Type	Balanced	Balanced	Balanced	Balanced
2. Orifice Size	Orifice H (0.785 in ²)	Orifice J (1.287 in ²)	Orifice K (1.838 in ²)	Orifice L (2.853 in ²)
3. Valve Specification Level (VSL)	VSL-1	VSL-1	VSL-1	VSL-1
4. Standard	API 520	API 520	API 520	API 520
5. Inlet/Outlet Size Range (NPS)	1 ½" x 3"	2" x 3"	3" x 4"	3" x 4"
6. Inlet/Outlet end connection	ASME B16.5, RF x ASME B16.5, RF	ASME B16.5, RF x ASME B16.5, RF	ASME B16.5, RF x ASME B16.5, RF	ASME B16.5, RF x ASME B16.5, RF
7. Inlet/Outlet pressure class	150 x 150	150 x 150	150 x 150	150 x 150
8. Temperature	-100°C to 155°C	-100°C to 155°C	-100°C to 155°C	-100°C to 155°C
9. Material Class	Nickel Alloys	Nickel Alloys	Nickel Alloys	Nickel Alloys
10. Body and bonnet Material	UNS N06625	UNS N06625	UNS N06625	UNS N06625
11. Disc Material	UNS N06625	UNS N06625	UNS N06625	UNS N06625
12. Nozzle Material	ASTM B564 (UNS N06625)	ASTM B564 (UNS N06625)	ASTM B564 (UNS N06625)	ASTM B564 (UNS N06625)
13. Guide Material	AISI 316	AISI 316	AISI 316	AISI 316
14. Spindle Material	Martensitic SS 400 Series	Martensitic SS 400 Series	Martensitic SS 400 Series	Martensitic SS 400 Series
15. Spring Material	UNS N07750	UNS N07750	UNS N07750	UNS N07750
16. Bellow Material	UNS N06625	UNS N06625	UNS N06625	UNS N06625
17. Valve Testing	API 527	API 527	API 527	API 527
18. Notes	Not Applicable	Not Applicable	Not Applicable	Not Applicable

Valve Code	PSV-BB-1-N11M	PSV-BB-1-N11N	PSV-BB-1-N11P	PSV-BB-1-N11Q
Specs	B30	B30	B30	B30
1. Valve Type	Balanced	Balanced	Balanced	Balanced
2. Orifice Size	Orifice M (3.60 in ²)	Orifice N (4.34 in ²)	Orifice P (6.38 in ²)	Orifice Q (11.05 in ²)
3. Valve Specification Level (VSL)	VSL-1	VSL-1	VSL-1	VSL-1
4. Standard	API 520	API 520	API 520	API 520
5. Inlet/Outlet Size Range (NPS)	4" x 6"	4" x 6"	4" x 6"	6" x 8"
6. Inlet/Outlet end connection	ASME B16.5, RF x ASME B16.5, RF	ASME B16.5, RF x ASME B16.5, RF	ASME B16.5, RF x ASME B16.5, RF	ASME B16.5, RF x ASME B16.5, RF
7. Inlet/Outlet pressure class	150 x 150	150 x 150	150 x 150	150 x 150
8. Temperature	-100°C to 155°C	-100°C to 155°C	-100°C to 155°C	-100°C to 155°C
9. Material Class	Nickel Alloys	Nickel Alloys	Nickel Alloys	Nickel Alloys
10. Body and bonnet Material	UNS N06625	UNS N06625	UNS N06625	UNS N06625
11. Disc Material	UNS N06625	UNS N06625	UNS N06625	UNS N06625
12. Nozzle Material	ASTM B564 (UNS N06625)	ASTM B564 (UNS N06625)	ASTM B564 (UNS N06625)	ASTM B564 (UNS N06625)
13. Guide Material	AISI 316	AISI 316	AISI 316	AISI 316
14. Spindle Material	Martensitic SS 400 Series	Martensitic SS 400 Series	Martensitic SS 400 Series	Martensitic SS 400 Series
15. Spring Material	UNS N07750	UNS N07750	UNS N07750	UNS N07750
16. Bellow Material	UNS N06625	UNS N06625	UNS N06625	UNS N06625
17. Valve Testing	API 527	API 527	API 527	API 527
18. Notes	Not Applicable	Not Applicable	Not Applicable	Not Applicable

Valve Code	PSV-BB-1-N11R	PSV-BB-1-N11T	PSV-BB-1-S21D	PSV-BB-1-S21E
Specs	B30	B30	B3 B6 B9 B10 B19	B3 B6 B9 B10 B19
1. Valve Type	Balanced	Balanced	Balanced	Balanced
2. Orifice Size	Orifice R (16.00 in ²)	Orifice T (26.00 in ²)	Orifice D (A=0.110 in ²)	Orifice E (0.196 in ²)
3. Valve Specification Level (VSL)	VSL-1	VSL-1	VSL-1	VSL-1
4. Standard	API 520	API 520	API 520	API 520
5. Inlet/Outlet Size Range (NPS)	6" x 8"	8" x 10"	1" x 2"	1" x 2"
6. Inlet/Outlet end connection	ASME B16.5, RF x ASME B16.5, RF	ASME B16.5, RF x ASME B16.5, RF	ASME B16.5, RF x ASME B16.5, RF	ASME B16.5, RF x ASME B16.5, RF
7. Inlet/Outlet pressure class	150 x 150	150 x 150	150 x 150	150 x 150
8. Temperature	-100°C to 155°C	-100°C to 155°C	-100°C to 260°C	-100°C to 260°C
9. Material Class	Nickel Alloys	Nickel Alloys	Stainless Steel	Stainless Steel
10. Body and bonnet Material	UNS N06625	UNS N06625	ASTM A182 Gr CF8M	ASTM A182 Gr CF8M
11. Disc Material	UNS N06625	UNS N06625	AISI 316 + Stellite	AISI 316 + Stellite
12. Nozzle Material	ASTM B564 (UNS N06625)	ASTM B564 (UNS N06625)	AISI 316	AISI 316
13. Guide Material	AISI 316	AISI 316	AISI 316	AISI 316
14. Spindle Material	Martensitic SS 400 Series	Martensitic SS 400 Series	Martensitic SS 400 Series	Martensitic SS 400 Series
15. Spring Material	UNS N07750	UNS N07750	UNS N07750	UNS N07750
16. Bellow Material	UNS N06625	UNS N06625	UNS N06625	UNS N06625
17. Valve Testing	API 527	API 527	API 527	API 527
18. Notes	Not Applicable	Not Applicable	Not Applicable	Not Applicable

Valve Code	PSV-BB-1-S21F	PSV-BB-1-S21G	PSV-BB-1-S21H	PSV-BB-1-S21J
Specs	B3 B6 B9 B10 B19	B3 B6 B9 B10 B19	B3 B6 B9 B10 B19	B3 B6 B9 B10 B19
1. Valve Type	Balanced	Balanced	Balanced	Balanced
2. Orifice Size	Orifice F (0.307 in ²)	Orifice G (0.503 in ²)	Orifice H (0.785 in ²)	Orifice J (1.287 in ²)
3. Valve Specification Level (VSL)	VSL-1	VSL-1	VSL-1	VSL-1
4. Standard	API 520	API 520	API 520	API 520
5. Inlet/Outlet Size Range (NPS)	1 ½" x 2"	1 ½" x 3"	1 ½" x 3"	2" x 3"
6. Inlet/Outlet end connection	ASME B16.5, RF x ASME B16.5, RF	ASME B16.5, RF x ASME B16.5, RF	ASME B16.5, RF x ASME B16.5, RF	ASME B16.5, RF x ASME B16.5, RF
7. Inlet/Outlet pressure class	150 x 150	150 x 150	150 x 150	150 x 150
8. Temperature	-100°C to 260°C	-100°C to 260°C	-100°C to 260°C	-100°C to 260°C
9. Material Class	Stainless Steel	Stainless Steel	Stainless Steel	Stainless Steel
10. Body and bonnet Material	ASTM A182 Gr CF8M	ASTM A182 Gr CF8M	ASTM A182 Gr CF8M	ASTM A182 Gr CF8M
11. Disc Material	AISI 316 + Stellite	AISI 316 + Stellite	AISI 316 + Stellite	AISI 316 + Stellite
12. Nozzle Material	AISI 316	AISI 316	AISI 316	AISI 316
13. Guide Material	AISI 316	AISI 316	AISI 316	AISI 316
14. Spindle Material	Martensitic SS 400 Series	Martensitic SS 400 Series	Martensitic SS 400 Series	Martensitic SS 400 Series
15. Spring Material	UNS N07750	UNS N07750	UNS N07750	UNS N07750
16. Bellow Material	UNS N06625	UNS N06625	UNS N06625	UNS N06625
17. Valve Testing	API 527	API 527	API 527	API 527
18. Notes	Not Applicable	Not Applicable	Not Applicable	Not Applicable

Valve Code	PSV-BB-1-S21K	PSV-BB-1-S21L	PSV-BB-1-S21M	PSV-BB-1-S21N
Specs	B3 B6 B9 B10 B19	B3 B6 B9 B10 B19	B3 B6 B9 B10 B19	B3 B6 B9 B10 B19
1. Valve Type	Balanced	Balanced	Balanced	Balanced
2. Orifice Size	Orifice K (1.838 in ²)	Orifice L (2.853 in ²)	Orifice M (3.60 in ²)	Orifice N (4.34 in ²)
3. Valve Specification Level (VSL)	VSL-1	VSL-1	VSL-1	VSL-1
4. Standard	API 520	API 520	API 520	API 520
5. Inlet/Outlet Size Range (NPS)	3" x 4"	3" x 4"	4" x 6"	4" x 6"
6. Inlet/Outlet end connection	ASME B16.5, RF x ASME B16.5, RF	ASME B16.5, RF x ASME B16.5, RF	ASME B16.5, RF x ASME B16.5, RF	ASME B16.5, RF x ASME B16.5, RF
7. Inlet/Outlet pressure class	150 x 150	150 x 150	150 x 150	150 x 150
8. Temperature	-100°C to 260°C	-100°C to 260°C	-100°C to 260°C	-100°C to 260°C
9. Material Class	Stainless Steel	Stainless Steel	Stainless Steel	Stainless Steel
10. Body and bonnet Material	ASTM A182 Gr CF8M	ASTM A182 Gr CF8M	ASTM A182 Gr CF8M	ASTM A182 Gr CF8M
11. Disc Material	AISI 316 + Stellite	AISI 316 + Stellite	AISI 316 + Stellite	AISI 316 + Stellite
12. Nozzle Material	AISI 316	AISI 316	AISI 316	AISI 316
13. Guide Material	AISI 316	AISI 316	AISI 316	AISI 316
14. Spindle Material	Martensitic SS 400 Series	Martensitic SS 400 Series	Martensitic SS 400 Series	Martensitic SS 400 Series
15. Spring Material	UNS N07750	UNS N07750	UNS N07750	UNS N07750
16. Bellow Material	UNS N06625	UNS N06625	UNS N06625	UNS N06625
17. Valve Testing	API 527	API 527	API 527	API 527
18. Notes	Not Applicable	Not Applicable	Not Applicable	Not Applicable

Valve Code	PSV-BB-1-S21P	PSV-BB-1-S21Q	PSV-BB-1-S21R	PSV-BB-1-S21T
Specs	B3 B6 B9 B10 B19	B3 B6 B9 B10 B19	B3 B6 B9 B10 B19	B3 B6 B9 B10 B19
1. Valve Type	Balanced	Balanced	Balanced	Balanced
2. Orifice Size	Orifice P (6.38 in ²)	Orifice Q (11.05 in ²)	Orifice R (16.00 in ²)	Orifice T (26.00 in ²)
3. Valve Specification Level (VSL)	VSL-1	VSL-1	VSL-1	VSL-1
4. Standard	API 520	API 520	API 520	API 520
5. Inlet/Outlet Size Range (NPS)	4" x 6"	6" x 8"	6" x 8"	8" x 10"
6. Inlet/Outlet end connection	ASME B16.5, RF x ASME B16.5, RF	ASME B16.5, RF x ASME B16.5, RF	ASME B16.5, RF x ASME B16.5, RF	ASME B16.5, RF x ASME B16.5, RF
7. Inlet/Outlet pressure class	150 x 150	150 x 150	150 x 150	150 x 150
8. Temperature	-100°C to 260°C	-100°C to 260°C	-100°C to 260°C	-100°C to 260°C
9. Material Class	Stainless Steel	Stainless Steel	Stainless Steel	Stainless Steel
10. Body and bonnet Material	ASTM A182 Gr CF8M	ASTM A182 Gr CF8M	ASTM A182 Gr CF8M	ASTM A182 Gr CF8M
11. Disc Material	AISI 316 + Stellite	AISI 316 + Stellite	AISI 316 + Stellite	AISI 316 + Stellite
12. Nozzle Material	AISI 316	AISI 316	AISI 316	AISI 316
13. Guide Material	AISI 316	AISI 316	AISI 316	AISI 316
14. Spindle Material	Martensitic SS 400 Series	Martensitic SS 400 Series	Martensitic SS 400 Series	Martensitic SS 400 Series
15. Spring Material	UNS N07750	UNS N07750	UNS N07750	UNS N07750
16. Bellow Material	UNS N06625	UNS N06625	UNS N06625	UNS N06625
17. Valve Testing	API 527	API 527	API 527	API 527
18. Notes	Not Applicable	Not Applicable	Not Applicable	Not Applicable

Valve Code	PSV-BB-1-S22D	PSV-BB-1-S22E	PSV-BB-1-S22F	PSV-BB-1-S22G
Specs	B14	B14	B14	B14
1. Valve Type	Balanced with noble Trim	Balanced with noble Trim	Balanced with noble Trim	Balanced with noble Trim
2. Orifice Size	Orifice D (A=0.110 in ²)	Orifice E (0.196 in ²)	Orifice F (0.307 in ²)	Orifice G (0.503 in ²)
3. Valve Specification Level (VSL)	VSL-1	VSL-1	VSL-1	VSL-1
4. Standard	API 520	API 520	API 520	API 520
5. Inlet/Outlet Size Range (NPS)	1" x 2"	1" x 2"	1 ½" x 2"	1 ½" x 3"
6. Inlet/Outlet end connection	ASME B16.5, RF x ASME B16.5, RF	ASME B16.5, RF x ASME B16.5, RF	ASME B16.5, RF x ASME B16.5, RF	ASME B16.5, RF x ASME B16.5, RF
7. Inlet/Outlet pressure class	150 x 150	150 x 150	150 x 150	150 x 150
8. Temperature	0°C to 70°C	0°C to 70°C	0°C to 70°C	0°C to 70°C
9. Material Class	Stainless Steel	Stainless Steel	Stainless Steel	Stainless Steel
10. Body and bonnet Material	ASTM A182 Gr CF8M	ASTM A182 Gr CF8M	ASTM A182 Gr CF8M	ASTM A182 Gr CF8M
11. Disc Material	Hastelloy C	Hastelloy C	Hastelloy C	Hastelloy C
12. Nozzle Material	Hastelloy C	Hastelloy C	Hastelloy C	Hastelloy C
13. Guide Material	AISI 316	AISI 316	AISI 316	AISI 316
14. Spindle Material	Martensitic SS 400 Series	Martensitic SS 400 Series	Martensitic SS 400 Series	Martensitic SS 400 Series
15. Spring Material	UNS N07750	UNS N07750	UNS N07750	UNS N07750
16. Bellow Material	UNS N06625	UNS N06625	UNS N06625	UNS N06625
17. Valve Testing	API 527	API 527	API 527	API 527
18. Notes	Not Applicable	Not Applicable	Not Applicable	Not Applicable

Valve Code	PSV-BB-1-S22H	PSV-BB-1-S22J	PSV-BB-1-S22K	PSV-BB-1-S22L
Specs	B14	B14	B14	B14
1. Valve Type	Balanced with noble Trim	Balanced with noble Trim	Balanced with noble Trim	Balanced with noble Trim
2. Orifice Size	Orifice H (0.785 in ²)	Orifice J (1.287 in ²)	Orifice K (1.838 in ²)	Orifice L (2.853 in ²)
3. Valve Specification Level (VSL)	VSL-1	VSL-1	VSL-1	VSL-1
4. Standard	API 520	API 520	API 520	API 520
5. Inlet/Outlet Size Range (NPS)	1 ½" x 3"	2" x 3"	3" x 4"	3" x 4"
6. Inlet/Outlet end connection	ASME B16.5, RF x ASME B16.5, RF	ASME B16.5, RF x ASME B16.5, RF	ASME B16.5, RF x ASME B16.5, RF	ASME B16.5, RF x ASME B16.5, RF
7. Inlet/Outlet pressure class	150 x 150	150 x 150	150 x 150	150 x 150
8. Temperature	0°C to 70°C	0°C to 70°C	0°C to 70°C	0°C to 70°C
9. Material Class	Stainless Steel	Stainless Steel	Stainless Steel	Stainless Steel
10. Body and bonnet Material	ASTM A182 Gr CF8M	ASTM A182 Gr CF8M	ASTM A182 Gr CF8M	ASTM A182 Gr CF8M
11. Disc Material	Hastelloy C	Hastelloy C	Hastelloy C	Hastelloy C
12. Nozzle Material	Hastelloy C	Hastelloy C	Hastelloy C	Hastelloy C
13. Guide Material	AISI 316	AISI 316	AISI 316	AISI 316
14. Spindle Material	Martensitic SS 400 Series	Martensitic SS 400 Series	Martensitic SS 400 Series	Martensitic SS 400 Series
15. Spring Material	UNS N07750	UNS N07750	UNS N07750	UNS N07750
16. Bellow Material	UNS N06625	UNS N06625	UNS N06625	UNS N06625
17. Valve Testing	API 527	API 527	API 527	API 527
18. Notes	Not Applicable	Not Applicable	Not Applicable	Not Applicable

Valve Code	PSV-BB-1-S22M	PSV-BB-1-S22N	PSV-BB-1-S22P	PSV-BB-1-S22Q
Specs	B14	B14	B14	B14
1. Valve Type	Balanced with nobble Trim	Balanced with nobble Trim	Balanced with nobble Trim	Balanced with nobble Trim
2. Orifice Size	Orifice M (3.60 in ²)	Orifice N (4.34 in ²)	Orifice P (6.38 in ²)	Orifice Q (11.05 in ²)
3. Valve Specification Level (VSL)	VSL-1	VSL-1	VSL-1	VSL-1
4. Standard	API 520	API 520	API 520	API 520
5. Inlet/Outlet Size Range (NPS)	4" x 6"	4" x 6"	4" x 6"	6" x 8"
6. Inlet/Outlet end connection	ASME B16.5, RF x ASME B16.5, RF	ASME B16.5, RF x ASME B16.5, RF	ASME B16.5, RF x ASME B16.5, RF	ASME B16.5, RF x ASME B16.5, RF
7. Inlet/Outlet pressure class	150 x 150	150 x 150	150 x 150	150 x 150
8. Temperature	0°C to 70°C	0°C to 70°C	0°C to 70°C	0°C to 70°C
9. Material Class	Stainless Steel	Stainless Steel	Stainless Steel	Stainless Steel
10. Body and bonnet Material	ASTM A182 Gr CF8M	ASTM A182 Gr CF8M	ASTM A182 Gr CF8M	ASTM A182 Gr CF8M
11. Disc Material	Hastelloy C	Hastelloy C	Hastelloy C	Hastelloy C
12. Nozzle Material	Hastelloy C	Hastelloy C	Hastelloy C	Hastelloy C
13. Guide Material	AISI 316	AISI 316	AISI 316	AISI 316
14. Spindle Material	Martensitic SS 400 Series	Martensitic SS 400 Series	Martensitic SS 400 Series	Martensitic SS 400 Series
15. Spring Material	UNS N07750	UNS N07750	UNS N07750	UNS N07750
16. Bellow Material	UNS N06625	UNS N06625	UNS N06625	UNS N06625
17. Valve Testing	API 527	API 527	API 527	API 527
18. Notes	Not Applicable	Not Applicable	Not Applicable	Not Applicable

Valve Code	PSV-BB-1-S22R	PSV-BB-1-S22T	PSV-BB-2-C10D	PSV-BB-2-C10E
Specs	B14	B14	B4 B9 B10	B4 B9 B10
1. Valve Type	Balanced with nobble Trim	Balanced with nobble Trim	Conventional	Conventional
2. Orifice Size	Orifice R (16.00 in ²)	Orifice T (26.00 in ²)	Orifice D (A=0.110 in ²)	Orifice E (0.196 in ²)
3. Valve Specification Level (VSL)	VSL-1	VSL-1	VSL-2	VSL-2
4. Standard	API 520	API 520	API 520	API 520
5. Inlet/Outlet Size Range (NPS)	6" x 8"	8" x 10"	1" x 2"	1" x 2"
6. Inlet/Outlet end connection	ASME B16.5, RF x ASME B16.5, RF	ASME B16.5, RF x ASME B16.5, RF	ASME B16.5, RF x ASME B16.5, RF	ASME B16.5, RF x ASME B16.5, RF
7. Inlet/Outlet pressure class	150 x 150	150 x 150	150 x 150	150 x 150
8. Temperature	0°C to 70°C	0°C to 70°C	0°C to 240°C	0°C to 240°C
9. Material Class	Stainless Steel	Stainless Steel	Carbon Steel	Carbon Steel
10. Body and bonnet Material	ASTM A182 Gr CF8M	ASTM A182 Gr CF8M	ASTM A216 Gr WCB	ASTM A216 Gr WCB
11. Disc Material	Hastelloy C	Hastelloy C	Martensitic SS 400 Series	Martensitic SS 400 Series
12. Nozzle Material	Hastelloy C	Hastelloy C	AISI 316	AISI 316
13. Guide Material	AISI 316	AISI 316	AISI 316	AISI 316
14. Spindle Material	Martensitic SS 400 Series	Martensitic SS 400 Series	Martensitic SS 400 Series	Martensitic SS 400 Series
15. Spring Material	UNS N07750	UNS N07750	UNS N07750	UNS N07750
16. Bellow Material	UNS N06625	UNS N06625	Not applicable	Not applicable
17. Valve Testing	API 527	API 527	API 527	API 527
18. Notes	Not Applicable	Not Applicable	Not Applicable	Not Applicable

Valve Code	PSV-BB-2-C10F	PSV-BB-2-C10G	PSV-BB-2-C10H	PSV-BB-2-C10J
Specs	B4 B9 B10	B4 B9 B10	B4 B9 B10	B4 B9 B10
1. Valve Type	Conventional	Conventional	Conventional	Conventional
2. Orifice Size	Orifice F (0.307 in ²)	Orifice G (0.503 in ²)	Orifice H (0.785 in ²)	Orifice J (1.287 in ²)
3. Valve Specification Level (VSL)	VSL-2	VSL-2	VSL-2	VSL-2
4. Standard	API 520	API 520	API 520	API 520
5. Inlet/Outlet Size Range (NPS)	1 ½" x 2"	1 ½" x 3"	1 ½" x 3"	2" x 3"
6. Inlet/Outlet end connection	ASME B16.5, RF x ASME B16.5, RF	ASME B16.5, RF x ASME B16.5, RF	ASME B16.5, RF x ASME B16.5, RF	ASME B16.5, RF x ASME B16.5, RF
7. Inlet/Outlet pressure class	150 x 150	150 x 150	150 x 150	150 x 150
8. Temperature	0°C to 240°C	0°C to 240°C	0°C to 240°C	0°C to 240°C
9. Material Class	Carbon Steel	Carbon Steel	Carbon Steel	Carbon Steel
10. Body and bonnet Material	ASTM A216 Gr WCB	ASTM A216 Gr WCB	ASTM A216 Gr WCB	ASTM A216 Gr WCB
11. Disc Material	Martensitic SS 400 Series	Martensitic SS 400 Series	Martensitic SS 400 Series	Martensitic SS 400 Series
12. Nozzle Material	AISI 316	AISI 316	AISI 316	AISI 316
13. Guide Material	AISI 316	AISI 316	AISI 316	AISI 316
14. Spindle Material	Martensitic SS 400 Series	Martensitic SS 400 Series	Martensitic SS 400 Series	Martensitic SS 400 Series
15. Spring Material	UNS N07750	UNS N07750	UNS N07750	UNS N07750
16. Bellow Material	Not applicable	Not applicable	Not applicable	Not applicable
17. Valve Testing	API 527	API 527	API 527	API 527
18. Notes	Not Applicable	Not Applicable	Not Applicable	Not Applicable

Valve Code	PSV-BB-2-C10K	PSV-BB-2-C10L	PSV-BB-2-C10M	PSV-BB-2-C10N
Specs	B4 B9 B10	B4 B9 B10	B4 B9 B10	B4 B9 B10
1. Valve Type	Conventional	Conventional	Conventional	Conventional
2. Orifice Size	Orifice K (1.838 in ²)	Orifice L (2.853 in ²)	Orifice M (3.60 in ²)	Orifice N (4.34 in ²)
3. Valve Specification Level (VSL)	VSL-2	VSL-2	VSL-2	VSL-2
4. Standard	API 520	API 520	API 520	API 520
5. Inlet/Outlet Size Range (NPS)	3" x 4"	3" x 4"	4" x 6"	4" x 6"
6. Inlet/Outlet end connection	ASME B16.5, RF x ASME B16.5, RF	ASME B16.5, RF x ASME B16.5, RF	ASME B16.5, RF x ASME B16.5, RF	ASME B16.5, RF x ASME B16.5, RF
7. Inlet/Outlet pressure class	150 x 150	150 x 150	150 x 150	150 x 150
8. Temperature	0°C to 240°C	0°C to 240°C	0°C to 240°C	0°C to 240°C
9. Material Class	Carbon Steel	Carbon Steel	Carbon Steel	Carbon Steel
10. Body and bonnet Material	ASTM A216 Gr WCB	ASTM A216 Gr WCB	ASTM A216 Gr WCB	ASTM A216 Gr WCB
11. Disc Material	Martensitic SS 400 Series	Martensitic SS 400 Series	Martensitic SS 400 Series	Martensitic SS 400 Series
12. Nozzle Material	AISI 316	AISI 316	AISI 316	AISI 316
13. Guide Material	AISI 316	AISI 316	AISI 316	AISI 316
14. Spindle Material	Martensitic SS 400 Series	Martensitic SS 400 Series	Martensitic SS 400 Series	Martensitic SS 400 Series
15. Spring Material	UNS N07750	UNS N07750	UNS N07750	UNS N07750
16. Bellow Material	Not applicable	Not applicable	Not applicable	Not applicable
17. Valve Testing	API 527	API 527	API 527	API 527
18. Notes	Not Applicable	Not Applicable	Not Applicable	Not Applicable

Valve Code	PSV-BB-2-C10P	PSV-BB-2-C10Q	PSV-BB-2-C10R	PSV-BB-2-C10T
Specs	B4 B9 B10	B4 B9 B10	B4 B9 B10	B4 B9 B10
1. Valve Type	Conventional	Conventional	Conventional	Conventional
2. Orifice Size	Orifice P (6.38 in ²)	Orifice Q (11.05 in ²)	Orifice R (16.00 in ²)	Orifice T (26.00 in ²)
3. Valve Specification Level (VSL)	VSL-2	VSL-2	VSL-2	VSL-2
4. Standard	API 520	API 520	API 520	API 520
5. Inlet/Outlet Size Range (NPS)	4" x 6"	6" x 8"	6" x 8"	8" x 10"
6. Inlet/Outlet end connection	ASME B16.5, RF x ASME B16.5, RF	ASME B16.5, RF x ASME B16.5, RF	ASME B16.5, RF x ASME B16.5, RF	ASME B16.5, RF x ASME B16.5, RF
7. Inlet/Outlet pressure class	150 x 150	150 x 150	150 x 150	150 x 150
8. Temperature	0°C to 240°C	0°C to 240°C	0°C to 240°C	0°C to 240°C
9. Material Class	Carbon Steel	Carbon Steel	Carbon Steel	Carbon Steel
10. Body and bonnet Material	ASTM A216 Gr WCB	ASTM A216 Gr WCB	ASTM A216 Gr WCB	ASTM A216 Gr WCB
11. Disc Material	Martensitic SS 400 Series	Martensitic SS 400 Series	Martensitic SS 400 Series	Martensitic SS 400 Series
12. Nozzle Material	AISI 316	AISI 316	AISI 316	AISI 316
13. Guide Material	AISI 316	AISI 316	AISI 316	AISI 316
14. Spindle Material	Martensitic SS 400 Series	Martensitic SS 400 Series	Martensitic SS 400 Series	Martensitic SS 400 Series
15. Spring Material	UNS N07750	UNS N07750	UNS N07750	UNS N07750
16. Bellow Material	Not applicable	Not applicable	Not applicable	Not applicable
17. Valve Testing	API 527	API 527	API 527	API 527
18. Notes	Not Applicable	Not Applicable	Not Applicable	Not Applicable

Valve Code	PSV-BB-2-C11D	PSV-BB-2-C11E	PSV-BB-2-C11F	PSV-BB-2-C11G
Specs	B4 B9 B10	B4 B9 B10	B4 B9 B10	B4 B9 B10
1. Valve Type	Balanced	Balanced	Balanced	Balanced
2. Orifice Size	Orifice D (A=0.110 in ²)	Orifice E (0.196 in ²)	Orifice F (0.307 in ²)	Orifice G (0.503 in ²)
3. Valve Specification Level (VSL)	VSL-2	VSL-2	VSL-2	VSL-2
4. Standard	API 520	API 520	API 520	API 520
5. Inlet/Outlet Size Range (NPS)	1" x 2"	1" x 2"	1 ½" x 2"	1 ½" x 3"
6. Inlet/Outlet end connection	ASME B16.5, RF x ASME B16.5, RF	ASME B16.5, RF x ASME B16.5, RF	ASME B16.5, RF x ASME B16.5, RF	ASME B16.5, RF x ASME B16.5, RF
7. Inlet/Outlet pressure class	150 x 150	150 x 150	150 x 150	150 x 150
8. Temperature	0°C to 240°C	0°C to 240°C	0°C to 240°C	0°C to 240°C
9. Material Class	Carbon Steel	Carbon Steel	Carbon Steel	Carbon Steel
10. Body and bonnet Material	ASTM A216 Gr WCB	ASTM A216 Gr WCB	ASTM A216 Gr WCB	ASTM A216 Gr WCB
11. Disc Material	Martensitic SS 400 Series	Martensitic SS 400 Series	Martensitic SS 400 Series	Martensitic SS 400 Series
12. Nozzle Material	AISI 316	AISI 316	AISI 316	AISI 316
13. Guide Material	AISI 316	AISI 316	AISI 316	AISI 316
14. Spindle Material	Martensitic SS 400 Series	Martensitic SS 400 Series	Martensitic SS 400 Series	Martensitic SS 400 Series
15. Spring Material	UNS N07750	UNS N07750	UNS N07750	UNS N07750
16. Bellow Material	UNS N06625	UNS N06625	UNS N06625	UNS N06625
17. Valve Testing	API 527	API 527	API 527	API 527
18. Notes	Not Applicable	Not Applicable	Not Applicable	Not Applicable

Valve Code	PSV-BB-2-C11H	PSV-BB-2-C11J	PSV-BB-2-C11K	PSV-BB-2-C11L
Specs	B4 B9 B10	B4 B9 B10	B4 B9 B10	B4 B9 B10
1. Valve Type	Balanced	Balanced	Balanced	Balanced
2. Orifice Size	Orifice H (0.785 in ²)	Orifice J (1.287 in ²)	Orifice K (1.838 in ²)	Orifice L (2.853 in ²)
3. Valve Specification Level (VSL)	VSL-2	VSL-2	VSL-2	VSL-2
4. Standard	API 520	API 520	API 520	API 520
5. Inlet/Outlet Size Range (NPS)	1 ½" x 3"	2" x 3"	3" x 4"	3" x 4"
6. Inlet/Outlet end connection	ASME B16.5, RF x ASME B16.5, RF	ASME B16.5, RF x ASME B16.5, RF	ASME B16.5, RF x ASME B16.5, RF	ASME B16.5, RF x ASME B16.5, RF
7. Inlet/Outlet pressure class	150 x 150	150 x 150	150 x 150	150 x 150
8. Temperature	0°C to 240°C	0°C to 240°C	0°C to 240°C	0°C to 240°C
9. Material Class	Carbon Steel	Carbon Steel	Carbon Steel	Carbon Steel
10. Body and bonnet Material	ASTM A216 Gr WCB	ASTM A216 Gr WCB	ASTM A216 Gr WCB	ASTM A216 Gr WCB
11. Disc Material	Martensitic SS 400 Series	Martensitic SS 400 Series	Martensitic SS 400 Series	Martensitic SS 400 Series
12. Nozzle Material	AISI 316	AISI 316	AISI 316	AISI 316
13. Guide Material	AISI 316	AISI 316	AISI 316	AISI 316
14. Spindle Material	Martensitic SS 400 Series	Martensitic SS 400 Series	Martensitic SS 400 Series	Martensitic SS 400 Series
15. Spring Material	UNS N07750	UNS N07750	UNS N07750	UNS N07750
16. Bellow Material	UNS N06625	UNS N06625	UNS N06625	UNS N06625
17. Valve Testing	API 527	API 527	API 527	API 527
18. Notes	Not Applicable	Not Applicable	Not Applicable	Not Applicable

Valve Code	PSV-BB-2-C11M	PSV-BB-2-C11N	PSV-BB-2-C11P	PSV-BB-2-C11Q
Specs	B4 B9 B10	B4 B9 B10	B4 B9 B10	B4 B9 B10
1. Valve Type	Balanced	Balanced	Balanced	Balanced
2. Orifice Size	Orifice M (3.60 in ²)	Orifice N (4.34 in ²)	Orifice P (6.38 in ²)	Orifice Q (11.05 in ²)
3. Valve Specification Level (VSL)	VSL-2	VSL-2	VSL-2	VSL-2
4. Standard	API 520	API 520	API 520	API 520
5. Inlet/Outlet Size Range (NPS)	4" x 6"	4" x 6"	4" x 6"	6" x 8"
6. Inlet/Outlet end connection	ASME B16.5, RF x ASME B16.5, RF	ASME B16.5, RF x ASME B16.5, RF	ASME B16.5, RF x ASME B16.5, RF	ASME B16.5, RF x ASME B16.5, RF
7. Inlet/Outlet pressure class	150 x 150	150 x 150	150 x 150	150 x 150
8. Temperature	0°C to 240°C	0°C to 240°C	0°C to 240°C	0°C to 240°C
9. Material Class	Carbon Steel	Carbon Steel	Carbon Steel	Carbon Steel
10. Body and bonnet Material	ASTM A216 Gr WCB	ASTM A216 Gr WCB	ASTM A216 Gr WCB	ASTM A216 Gr WCB
11. Disc Material	Martensitic SS 400 Series	Martensitic SS 400 Series	Martensitic SS 400 Series	Martensitic SS 400 Series
12. Nozzle Material	AISI 316	AISI 316	AISI 316	AISI 316
13. Guide Material	AISI 316	AISI 316	AISI 316	AISI 316
14. Spindle Material	Martensitic SS 400 Series	Martensitic SS 400 Series	Martensitic SS 400 Series	Martensitic SS 400 Series
15. Spring Material	UNS N07750	UNS N07750	UNS N07750	UNS N07750
16. Bellow Material	UNS N06625	UNS N06625	UNS N06625	UNS N06625
17. Valve Testing	API 527	API 527	API 527	API 527
18. Notes	Not Applicable	Not Applicable	Not Applicable	Not Applicable

Valve Code	PSV-BB-2-C11R	PSV-BB-2-C11T	PSV-BB-2-C20D	PSV-BB-2-C20E
Specs	B4 B9 B10	B4 B9 B10	B6 B9 B10 B19	B6 B9 B10 B19
1. Valve Type	Balanced	Balanced	Conventional	Conventional
2. Orifice Size	Orifice R (16.00 in ²)	Orifice T (26.00 in ²)	Orifice D (A=0.110 in ²)	Orifice E (0.196 in ²)
3. Valve Specification Level (VSL)	VSL-2	VSL-2	VSL-2	VSL-2
4. Standard	API 520	API 520	API 520	API 520
5. Inlet/Outlet Size Range (NPS)	6" x 8"	8" x 10"	1" x 2"	1" x 2"
6. Inlet/Outlet end connection	ASME B16.5, RF x ASME B16.5, RF	ASME B16.5, RF x ASME B16.5, RF	ASME B16.5, RF x ASME B16.5, RF	ASME B16.5, RF x ASME B16.5, RF
7. Inlet/Outlet pressure class	150 x 150	150 x 150	150 x 150	150 x 150
8. Temperature	0°C to 240°C	0°C to 240°C	-46°C to 240°C	-46°C to 240°C
9. Material Class	Carbon Steel	Carbon Steel	Carbon Steel	Carbon Steel
10. Body and bonnet Material	ASTM A216 Gr WCB	ASTM A216 Gr WCB	ASTM A352 Gr LCB	ASTM A352 Gr LCB
11. Disc Material	Martensitic SS 400 Series	Martensitic SS 400 Series	AISI 316 + Stellite	AISI 316 + Stellite
12. Nozzle Material	AISI 316	AISI 316	AISI 316	AISI 316
13. Guide Material	AISI 316	AISI 316	AISI 316	AISI 316
14. Spindle Material	Martensitic SS 400 Series	Martensitic SS 400 Series	Martensitic SS 400 Series	Martensitic SS 400 Series
15. Spring Material	UNS N07750	UNS N07750	UNS N07750	UNS N07750
16. Bellow Material	UNS N06625	UNS N06625	Not applicable	Not applicable
17. Valve Testing	API 527	API 527	API 527	API 527
18. Notes	Not Applicable	Not Applicable	Not Applicable	Not Applicable

Valve Code	PSV-BB-2-C20F	PSV-BB-2-C20G	PSV-BB-2-C20H	PSV-BB-2-C20J
Specs	B6 B9 B10 B19	B6 B9 B10 B19	B6 B9 B10 B19	B6 B9 B10 B19
1. Valve Type	Conventional	Conventional	Conventional	Conventional
2. Orifice Size	Orifice F (0.307 in ²)	Orifice G (0.503 in ²)	Orifice H (0.785 in ²)	Orifice J (1.287 in ²)
3. Valve Specification Level (VSL)	VSL-2	VSL-2	VSL-2	VSL-2
4. Standard	API 520	API 520	API 520	API 520
5. Inlet/Outlet Size Range (NPS)	1 ½" x 2"	1 ½" x 3"	1 ½" x 3"	2" x 3"
6. Inlet/Outlet end connection	ASME B16.5, RF x ASME B16.5, RF	ASME B16.5, RF x ASME B16.5, RF	ASME B16.5, RF x ASME B16.5, RF	ASME B16.5, RF x ASME B16.5, RF
7. Inlet/Outlet pressure class	150 x 150	150 x 150	150 x 150	150 x 150
8. Temperature	-46°C to 240°C	-46°C to 240°C	-46°C to 240°C	-46°C to 240°C
9. Material Class	Carbon Steel	Carbon Steel	Carbon Steel	Carbon Steel
10. Body and bonnet Material	ASTM A352 Gr LCB	ASTM A352 Gr LCB	ASTM A352 Gr LCB	ASTM A352 Gr LCB
11. Disc Material	AISI 316 + Stellite	AISI 316 + Stellite	AISI 316 + Stellite	AISI 316 + Stellite
12. Nozzle Material	AISI 316	AISI 316	AISI 316	AISI 316
13. Guide Material	AISI 316	AISI 316	AISI 316	AISI 316
14. Spindle Material	Martensitic SS 400 Series	Martensitic SS 400 Series	Martensitic SS 400 Series	Martensitic SS 400 Series
15. Spring Material	UNS N07750	UNS N07750	UNS N07750	UNS N07750
16. Bellow Material	Not applicable	Not applicable	Not applicable	Not applicable
17. Valve Testing	API 527	API 527	API 527	API 527
18. Notes	Not Applicable	Not Applicable	Not Applicable	Not Applicable

Valve Code	PSV-BB-2-C20K	PSV-BB-2-C20L	PSV-BB-2-C20M	PSV-BB-2-C20N
Specs	B6 B9 B10 B19	B6 B9 B10 B19	B6 B9 B10 B19	B6 B9 B10 B19
1. Valve Type	Conventional	Conventional	Conventional	Conventional
2. Orifice Size	Orifice K (1.838 in ²)	Orifice L (2.853 in ²)	Orifice M (3.60 in ²)	Orifice N (4.34 in ²)
3. Valve Specification Level (VSL)	VSL-2	VSL-2	VSL-2	VSL-2
4. Standard	API 520	API 520	API 520	API 520
5. Inlet/Outlet Size Range (NPS)	3" x 4"	3" x 4"	4" x 6"	4" x 6"
6. Inlet/Outlet end connection	ASME B16.5, RF x ASME B16.5, RF	ASME B16.5, RF x ASME B16.5, RF	ASME B16.5, RF x ASME B16.5, RF	ASME B16.5, RF x ASME B16.5, RF
7. Inlet/Outlet pressure class	150 x 150	150 x 150	150 x 150	150 x 150
8. Temperature	-46°C to 240°C	-46°C to 240°C	-46°C to 240°C	-46°C to 240°C
9. Material Class	Carbon Steel	Carbon Steel	Carbon Steel	Carbon Steel
10. Body and bonnet Material	ASTM A352 Gr LCB	ASTM A352 Gr LCB	ASTM A352 Gr LCB	ASTM A352 Gr LCB
11. Disc Material	AISI 316 + Stellite	AISI 316 + Stellite	AISI 316 + Stellite	AISI 316 + Stellite
12. Nozzle Material	AISI 316	AISI 316	AISI 316	AISI 316
13. Guide Material	AISI 316	AISI 316	AISI 316	AISI 316
14. Spindle Material	Martensitic SS 400 Series	Martensitic SS 400 Series	Martensitic SS 400 Series	Martensitic SS 400 Series
15. Spring Material	UNS N07750	UNS N07750	UNS N07750	UNS N07750
16. Bellow Material	Not applicable	Not applicable	Not applicable	Not applicable
17. Valve Testing	API 527	API 527	API 527	API 527
18. Notes	Not Applicable	Not Applicable	Not Applicable	Not Applicable

Valve Code	PSV-BB-2-C20P	PSV-BB-2-C20Q	PSV-BB-2-C20R	PSV-BB-2-C20T
Specs	B6 B9 B10 B19	B6 B9 B10 B19	B6 B9 B10 B19	B6 B9 B10 B19
1. Valve Type	Conventional	Conventional	Conventional	Conventional
2. Orifice Size	Orifice P (6.38 in ²)	Orifice Q (11.05 in ²)	Orifice R (16.00 in ²)	Orifice T (26.00 in ²)
3. Valve Specification Level (VSL)	VSL-2	VSL-2	VSL-2	VSL-2
4. Standard	API 520	API 520	API 520	API 520
5. Inlet/Outlet Size Range (NPS)	4" x 6"	6" x 8"	6" x 8"	8" x 10"
6. Inlet/Outlet end connection	ASME B16.5, RF x ASME B16.5, RF	ASME B16.5, RF x ASME B16.5, RF	ASME B16.5, RF x ASME B16.5, RF	ASME B16.5, RF x ASME B16.5, RF
7. Inlet/Outlet pressure class	150 x 150	150 x 150	150 x 150	150 x 150
8. Temperature	-46°C to 240°C	-46°C to 240°C	-46°C to 240°C	-46°C to 240°C
9. Material Class	Carbon Steel	Carbon Steel	Carbon Steel	Carbon Steel
10. Body and bonnet Material	ASTM A352 Gr LCB	ASTM A352 Gr LCB	ASTM A352 Gr LCB	ASTM A352 Gr LCB
11. Disc Material	AISI 316 + Stellite	AISI 316 + Stellite	AISI 316 + Stellite	AISI 316 + Stellite
12. Nozzle Material	AISI 316	AISI 316	AISI 316	AISI 316
13. Guide Material	AISI 316	AISI 316	AISI 316	AISI 316
14. Spindle Material	Martensitic SS 400 Series	Martensitic SS 400 Series	Martensitic SS 400 Series	Martensitic SS 400 Series
15. Spring Material	UNS N07750	UNS N07750	UNS N07750	UNS N07750
16. Bellow Material	Not applicable	Not applicable	Not applicable	Not applicable
17. Valve Testing	API 527	API 527	API 527	API 527
18. Notes	Not Applicable	Not Applicable	Not Applicable	Not Applicable

Valve Code	PSV-BB-2-C21D	PSV-BB-2-C21E	PSV-BB-2-C21F	PSV-BB-2-C21G
Specs	B6 B9 B10 B19	B6 B9 B10 B19	B6 B9 B10 B19	B6 B9 B10 B19
1. Valve Type	Balanced	Balanced	Balanced	Balanced
2. Orifice Size	Orifice D (A=0.110 in ²)	Orifice E (0.196 in ²)	Orifice F (0.307 in ²)	Orifice G (0.503 in ²)
3. Valve Specification Level (VSL)	VSL-2	VSL-2	VSL-2	VSL-2
4. Standard	API 520	API 520	API 520	API 520
5. Inlet/Outlet Size Range (NPS)	1" x 2"	1" x 2"	1 ½" x 2"	1 ½" x 3"
6. Inlet/Outlet end connection	ASME B16.5, RF x ASME B16.5, RF	ASME B16.5, RF x ASME B16.5, RF	ASME B16.5, RF x ASME B16.5, RF	ASME B16.5, RF x ASME B16.5, RF
7. Inlet/Outlet pressure class	150 x 150	150 x 150	150 x 150	150 x 150
8. Temperature	-46°C to 240°C	-46°C to 240°C	-46°C to 240°C	-46°C to 240°C
9. Material Class	Carbon Steel	Carbon Steel	Carbon Steel	Carbon Steel
10. Body and bonnet Material	ASTM A352 Gr LCB	ASTM A352 Gr LCB	ASTM A352 Gr LCB	ASTM A352 Gr LCB
11. Disc Material	AISI 316 + Stellite	AISI 316 + Stellite	AISI 316 + Stellite	AISI 316 + Stellite
12. Nozzle Material	AISI 316	AISI 316	AISI 316	AISI 316
13. Guide Material	AISI 316	AISI 316	AISI 316	AISI 316
14. Spindle Material	Martensitic SS 400 Series	Martensitic SS 400 Series	Martensitic SS 400 Series	Martensitic SS 400 Series
15. Spring Material	UNS N07750	UNS N07750	UNS N07750	UNS N07750
16. Bellow Material	UNS N06625	UNS N06625	UNS N06625	UNS N06625
17. Valve Testing	API 527	API 527	API 527	API 527
18. Notes	Not Applicable	Not Applicable	Not Applicable	Not Applicable

Valve Code	PSV-BB-2-C21H	PSV-BB-2-C21J	PSV-BB-2-C21K	PSV-BB-2-C21L
Specs	B6 B9 B10 B19	B6 B9 B10 B19	B6 B9 B10 B19	B6 B9 B10 B19
1. Valve Type	Balanced	Balanced	Balanced	Balanced
2. Orifice Size	Orifice H (0.785 in ²)	Orifice J (1.287 in ²)	Orifice K (1.838 in ²)	Orifice L (2.853 in ²)
3. Valve Specification Level (VSL)	VSL-2	VSL-2	VSL-2	VSL-2
4. Standard	API 520	API 520	API 520	API 520
5. Inlet/Outlet Size Range (NPS)	1 ½" x 3"	2" x 3"	3" x 4"	3" x 4"
6. Inlet/Outlet end connection	ASME B16.5, RF x ASME B16.5, RF	ASME B16.5, RF x ASME B16.5, RF	ASME B16.5, RF x ASME B16.5, RF	ASME B16.5, RF x ASME B16.5, RF
7. Inlet/Outlet pressure class	150 x 150	150 x 150	150 x 150	150 x 150
8. Temperature	-46°C to 240°C	-46°C to 240°C	-46°C to 240°C	-46°C to 240°C
9. Material Class	Carbon Steel	Carbon Steel	Carbon Steel	Carbon Steel
10. Body and bonnet Material	ASTM A352 Gr LCB	ASTM A352 Gr LCB	ASTM A352 Gr LCB	ASTM A352 Gr LCB
11. Disc Material	AISI 316 + Stellite	AISI 316 + Stellite	AISI 316 + Stellite	AISI 316 + Stellite
12. Nozzle Material	AISI 316	AISI 316	AISI 316	AISI 316
13. Guide Material	AISI 316	AISI 316	AISI 316	AISI 316
14. Spindle Material	Martensitic SS 400 Series	Martensitic SS 400 Series	Martensitic SS 400 Series	Martensitic SS 400 Series
15. Spring Material	UNS N07750	UNS N07750	UNS N07750	UNS N07750
16. Bellow Material	UNS N06625	UNS N06625	UNS N06625	UNS N06625
17. Valve Testing	API 527	API 527	API 527	API 527
18. Notes	Not Applicable	Not Applicable	Not Applicable	Not Applicable

Valve Code	PSV-BB-2-C21M	PSV-BB-2-C21N	PSV-BB-2-C21P	PSV-BB-2-C21Q
Specs	B6 B9 B10 B19	B6 B9 B10 B19	B6 B9 B10 B19	B6 B9 B10 B19
1. Valve Type	Balanced	Balanced	Balanced	Balanced
2. Orifice Size	Orifice M (3.60 in ²)	Orifice N (4.34 in ²)	Orifice P (6.38 in ²)	Orifice Q (11.05 in ²)
3. Valve Specification Level (VSL)	VSL-2	VSL-2	VSL-2	VSL-2
4. Standard	API 520	API 520	API 520	API 520
5. Inlet/Outlet Size Range (NPS)	4" x 6"	4" x 6"	4" x 6"	6" x 8"
6. Inlet/Outlet end connection	ASME B16.5, RF x ASME B16.5, RF	ASME B16.5, RF x ASME B16.5, RF	ASME B16.5, RF x ASME B16.5, RF	ASME B16.5, RF x ASME B16.5, RF
7. Inlet/Outlet pressure class	150 x 150	150 x 150	150 x 150	150 x 150
8. Temperature	-46°C to 240°C	-46°C to 240°C	-46°C to 240°C	-46°C to 240°C
9. Material Class	Carbon Steel	Carbon Steel	Carbon Steel	Carbon Steel
10. Body and bonnet Material	ASTM A352 Gr LCB	ASTM A352 Gr LCB	ASTM A352 Gr LCB	ASTM A352 Gr LCB
11. Disc Material	AISI 316 + Stellite	AISI 316 + Stellite	AISI 316 + Stellite	AISI 316 + Stellite
12. Nozzle Material	AISI 316	AISI 316	AISI 316	AISI 316
13. Guide Material	AISI 316	AISI 316	AISI 316	AISI 316
14. Spindle Material	Martensitic SS 400 Series	Martensitic SS 400 Series	Martensitic SS 400 Series	Martensitic SS 400 Series
15. Spring Material	UNS N07750	UNS N07750	UNS N07750	UNS N07750
16. Bellow Material	UNS N06625	UNS N06625	UNS N06625	UNS N06625
17. Valve Testing	API 527	API 527	API 527	API 527
18. Notes	Not Applicable	Not Applicable	Not Applicable	Not Applicable

Valve Code	PSV-BB-2-C21R	PSV-BB-2-C21T	PSV-BB-2-D21D	PSV-BB-2-D21E
Specs	B6 B9 B10 B19	B6 B9 B10 B19	B16	B16
1. Valve Type	Balanced	Balanced	Balanced	Balanced
2. Orifice Size	Orifice R (16.00 in ²)	Orifice T (26.00 in ²)	Orifice D (A=0.110 in ²)	Orifice E (0.196 in ²)
3. Valve Specification Level (VSL)	VSL-2	VSL-2	VSL-2	VSL-2
4. Standard	API 520	API 520	API 520	API 520
5. Inlet/Outlet Size Range (NPS)	6" x 8"	8" x 10"	1" x 2"	1" x 2"
6. Inlet/Outlet end connection	ASME B16.5, RF x ASME B16.5, RF	ASME B16.5, RF x ASME B16.5, RF	ASME B16.5, RF x ASME B16.5, RF	ASME B16.5, RF x ASME B16.5, RF
7. Inlet/Outlet pressure class	150 x 150	150 x 150	150 x 150	150 x 150
8. Temperature	-46°C to 240°C	-46°C to 240°C	-50°C to 100°C	-50°C to 100°C
9. Material Class	Carbon Steel	Carbon Steel	Duplex Steel	Duplex Steel
10. Body and bonnet Material	ASTM A352 Gr LCB	ASTM A352 Gr LCB	ASTM A995 Gr 4a	ASTM A995 Gr 4a
11. Disc Material	AISI 316 + Stellite	AISI 316 + Stellite	ASTM A479 (UNS S31803)	ASTM A479 (UNS S31803)
12. Nozzle Material	AISI 316	AISI 316	ASTM A479 (UNS S31803)	ASTM A479 (UNS S31803)
13. Guide Material	AISI 316	AISI 316	AISI 316	AISI 316
14. Spindle Material	Martensitic SS 400 Series	Martensitic SS 400 Series	Martensitic SS 400 Series	Martensitic SS 400 Series
15. Spring Material	UNS N07750	UNS N07750	UNS N07750	UNS N07750
16. Bellow Material	UNS N06625	UNS N06625	UNS N06625	UNS N06625
17. Valve Testing	API 527	API 527	API 527	API 527
18. Notes	Not Applicable	Not Applicable	Not Applicable	Not Applicable

Valve Code	PSV-BB-2-D21F	PSV-BB-2-D21G	PSV-BB-2-D21H	PSV-BB-2-D21J
Specs	B16	B16	B16	B16
1. Valve Type	Balanced	Balanced	Balanced	Balanced
2. Orifice Size	Orifice F (0.307 in ²)	Orifice G (0.503 in ²)	Orifice H (0.785 in ²)	Orifice J (1.287 in ²)
3. Valve Specification Level (VSL)	VSL-2	VSL-2	VSL-2	VSL-2
4. Standard	API 520	API 520	API 520	API 520
5. Inlet/Outlet Size Range (NPS)	1 ½" x 2"	1 ½" x 3"	1 ½" x 3"	2" x 3"
6. Inlet/Outlet end connection	ASME B16.5, RF x ASME B16.5, RF	ASME B16.5, RF x ASME B16.5, RF	ASME B16.5, RF x ASME B16.5, RF	ASME B16.5, RF x ASME B16.5, RF
7. Inlet/Outlet pressure class	150 x 150	150 x 150	150 x 150	150 x 150
8. Temperature	-50°C to 100°C	-50°C to 100°C	-50°C to 100°C	-50°C to 100°C
9. Material Class	Duplex Steel	Duplex Steel	Duplex Steel	Duplex Steel
10. Body and bonnet Material	ASTM A995 Gr 4a	ASTM A995 Gr 4a	ASTM A995 Gr 4a	ASTM A995 Gr 4a
11. Disc Material	ASTM A479 (UNS S31803)	ASTM A479 (UNS S31803)	ASTM A479 (UNS S31803)	ASTM A479 (UNS S31803)
12. Nozzle Material	ASTM A479 (UNS S31803)	ASTM A479 (UNS S31803)	ASTM A479 (UNS S31803)	ASTM A479 (UNS S31803)
13. Guide Material	AISI 316	AISI 316	AISI 316	AISI 316
14. Spindle Material	Martensitic SS 400 Series	Martensitic SS 400 Series	Martensitic SS 400 Series	Martensitic SS 400 Series
15. Spring Material	UNS N07750	UNS N07750	UNS N07750	UNS N07750
16. Bellow Material	UNS N06625	UNS N06625	UNS N06625	UNS N06625
17. Valve Testing	API 527	API 527	API 527	API 527
18. Notes	Not Applicable	Not Applicable	Not Applicable	Not Applicable

Valve Code	PSV-BB-2-D21K	PSV-BB-2-D21L	PSV-BB-2-D21M	PSV-BB-2-D21N
Specs	B16	B16	B16	B16
1. Valve Type	Balanced	Balanced	Balanced	Balanced
2. Orifice Size	Orifice K (1.838 in ²)	Orifice L (2.853 in ²)	Orifice M (3.60 in ²)	Orifice N (4.34 in ²)
3. Valve Specification Level (VSL)	VSL-2	VSL-2	VSL-2	VSL-2
4. Standard	API 520	API 520	API 520	API 520
5. Inlet/Outlet Size Range (NPS)	3" x 4"	3" x 4"	4" x 6"	4" x 6"
6. Inlet/Outlet end connection	ASME B16.5, RF x ASME B16.5, RF	ASME B16.5, RF x ASME B16.5, RF	ASME B16.5, RF x ASME B16.5, RF	ASME B16.5, RF x ASME B16.5, RF
7. Inlet/Outlet pressure class	150 x 150	150 x 150	150 x 150	150 x 150
8. Temperature	-50°C to 100°C	-50°C to 100°C	-50°C to 100°C	-50°C to 100°C
9. Material Class	Duplex Steel	Duplex Steel	Duplex Steel	Duplex Steel
10. Body and bonnet Material	ASTM A995 Gr 4a	ASTM A995 Gr 4a	ASTM A995 Gr 4a	ASTM A995 Gr 4a
11. Disc Material	ASTM A479 (UNS S31803)	ASTM A479 (UNS S31803)	ASTM A479 (UNS S31803)	ASTM A479 (UNS S31803)
12. Nozzle Material	ASTM A479 (UNS S31803)	ASTM A479 (UNS S31803)	ASTM A479 (UNS S31803)	ASTM A479 (UNS S31803)
13. Guide Material	AISI 316	AISI 316	AISI 316	AISI 316
14. Spindle Material	Martensitic SS 400 Series	Martensitic SS 400 Series	Martensitic SS 400 Series	Martensitic SS 400 Series
15. Spring Material	UNS N07750	UNS N07750	UNS N07750	UNS N07750
16. Bellow Material	UNS N06625	UNS N06625	UNS N06625	UNS N06625
17. Valve Testing	API 527	API 527	API 527	API 527
18. Notes	Not Applicable	Not Applicable	Not Applicable	Not Applicable

Valve Code	PSV-BB-2-D21P	PSV-BB-2-D21Q	PSV-BB-2-D21R	PSV-BB-2-D21T
Specs	B16	B16	B16	B16
1. Valve Type	Balanced	Balanced	Balanced	Balanced
2. Orifice Size	Orifice P (6.38 in ²)	Orifice Q (11.05 in ²)	Orifice R (16.00 in ²)	Orifice T (26.00 in ²)
3. Valve Specification Level (VSL)	VSL-2	VSL-2	VSL-2	VSL-2
4. Standard	API 520	API 520	API 520	API 520
5. Inlet/Outlet Size Range (NPS)	4" x 6"	6" x 8"	6" x 8"	8" x 10"
6. Inlet/Outlet end connection	ASME B16.5, RF x ASME B16.5, RF	ASME B16.5, RF x ASME B16.5, RF	ASME B16.5, RF x ASME B16.5, RF	ASME B16.5, RF x ASME B16.5, RF
7. Inlet/Outlet pressure class	150 x 150	150 x 150	150 x 150	150 x 150
8. Temperature	-50°C to 100°C	-50°C to 100°C	-50°C to 100°C	-50°C to 100°C
9. Material Class	Duplex Steel	Duplex Steel	Duplex Steel	Duplex Steel
10. Body and bonnet Material	ASTM A995 Gr 4a	ASTM A995 Gr 4a	ASTM A995 Gr 4a	ASTM A995 Gr 4a
11. Disc Material	ASTM A479 (UNS S31803)	ASTM A479 (UNS S31803)	ASTM A479 (UNS S31803)	ASTM A479 (UNS S31803)
12. Nozzle Material	ASTM A479 (UNS S31803)	ASTM A479 (UNS S31803)	ASTM A479 (UNS S31803)	ASTM A479 (UNS S31803)
13. Guide Material	AISI 316	AISI 316	AISI 316	AISI 316
14. Spindle Material	Martensitic SS 400 Series	Martensitic SS 400 Series	Martensitic SS 400 Series	Martensitic SS 400 Series
15. Spring Material	UNS N07750	UNS N07750	UNS N07750	UNS N07750
16. Bellow Material	UNS N06625	UNS N06625	UNS N06625	UNS N06625
17. Valve Testing	API 527	API 527	API 527	API 527
18. Notes	Not Applicable	Not Applicable	Not Applicable	Not Applicable

Valve Code	PSV-BB-2-D31D	PSV-BB-2-D31E	PSV-BB-2-D31F	PSV-BB-2-D31G
Specs	B12	B12	B12	B12
1. Valve Type	Balanced	Balanced	Balanced	Balanced
2. Orifice Size	Orifice D (A=0.110 in ²)	Orifice E (0.196 in ²)	Orifice F (0.307 in ²)	Orifice G (0.503 in ²)
3. Valve Specification Level (VSL)	VSL-2	VSL-2	VSL-2	VSL-2
4. Standard	API 520	API 520	API 520	API 520
5. Inlet/Outlet Size Range (NPS)	1" x 2"	1" x 2"	1 ½" x 2"	1 ½" x 3"
6. Inlet/Outlet end connection	ASME B16.5, RF x ASME B16.5, RF	ASME B16.5, RF x ASME B16.5, RF	ASME B16.5, RF x ASME B16.5, RF	ASME B16.5, RF x ASME B16.5, RF
7. Inlet/Outlet pressure class	150 x 150	150 x 150	150 x 150	150 x 150
8. Temperature	-50°C to 110°C	-50°C to 110°C	-50°C to 110°C	-50°C to 110°C
9. Material Class	Duplex Steel	Duplex Steel	Duplex Steel	Duplex Steel
10. Body and bonnet Material	ASTM A995 Gr 6a	ASTM A995 Gr 6a	ASTM A995 Gr 6a	ASTM A995 Gr 6a
11. Disc Material	ASTM A479 (UNS S32760)	ASTM A479 (UNS S32760)	ASTM A479 (UNS S32760)	ASTM A479 (UNS S32760)
12. Nozzle Material	ASTM A479 (UNS S32760)	ASTM A479 (UNS S32760)	ASTM A479 (UNS S32760)	ASTM A479 (UNS S32760)
13. Guide Material	AISI 316	AISI 316	AISI 316	AISI 316
14. Spindle Material	Martensitic SS 400 Series	Martensitic SS 400 Series	Martensitic SS 400 Series	Martensitic SS 400 Series
15. Spring Material	UNS N07750	UNS N07750	UNS N07750	UNS N07750
16. Bellow Material	UNS N06625	UNS N06625	UNS N06625	UNS N06625
17. Valve Testing	API 527	API 527	API 527	API 527
18. Notes	Not Applicable	Not Applicable	Not Applicable	Not Applicable

Valve Code	PSV-BB-2-D31H	PSV-BB-2-D31J	PSV-BB-2-D31K	PSV-BB-2-D31L
Specs	B12	B12	B12	B12
1. Valve Type	Balanced	Balanced	Balanced	Balanced
2. Orifice Size	Orifice H (0.785 in ²)	Orifice J (1.287 in ²)	Orifice K (1.838 in ²)	Orifice L (2.853 in ²)
3. Valve Specification Level (VSL)	VSL-2	VSL-2	VSL-2	VSL-2
4. Standard	API 520	API 520	API 520	API 520
5. Inlet/Outlet Size Range (NPS)	1 ½" x 3"	2" x 3"	3" x 4"	3" x 4"
6. Inlet/Outlet end connection	ASME B16.5, RF x ASME B16.5, RF	ASME B16.5, RF x ASME B16.5, RF	ASME B16.5, RF x ASME B16.5, RF	ASME B16.5, RF x ASME B16.5, RF
7. Inlet/Outlet pressure class	150 x 150	150 x 150	150 x 150	150 x 150
8. Temperature	-50°C to 110°C	-50°C to 110°C	-50°C to 110°C	-50°C to 110°C
9. Material Class	Duplex Steel	Duplex Steel	Duplex Steel	Duplex Steel
10. Body and bonnet Material	ASTM A995 Gr 6a	ASTM A995 Gr 6a	ASTM A995 Gr 6a	ASTM A995 Gr 6a
11. Disc Material	ASTM A479 (UNS S32760)	ASTM A479 (UNS S32760)	ASTM A479 (UNS S32760)	ASTM A479 (UNS S32760)
12. Nozzle Material	ASTM A479 (UNS S32760)	ASTM A479 (UNS S32760)	ASTM A479 (UNS S32760)	ASTM A479 (UNS S32760)
13. Guide Material	AISI 316	AISI 316	AISI 316	AISI 316
14. Spindle Material	Martensitic SS 400 Series	Martensitic SS 400 Series	Martensitic SS 400 Series	Martensitic SS 400 Series
15. Spring Material	UNS N07750	UNS N07750	UNS N07750	UNS N07750
16. Bellow Material	UNS N06625	UNS N06625	UNS N06625	UNS N06625
17. Valve Testing	API 527	API 527	API 527	API 527
18. Notes	Not Applicable	Not Applicable	Not Applicable	Not Applicable

Valve Code	PSV-BB-2-D31M	PSV-BB-2-D31N	PSV-BB-2-D31P	PSV-BB-2-D31Q
Specs	B12	B12	B12	B12
1. Valve Type	Balanced	Balanced	Balanced	Balanced
2. Orifice Size	Orifice M (3.60 in ²)	Orifice N (4.34 in ²)	Orifice P (6.38 in ²)	Orifice Q (11.05 in ²)
3. Valve Specification Level (VSL)	VSL-2	VSL-2	VSL-2	VSL-2
4. Standard	API 520	API 520	API 520	API 520
5. Inlet/Outlet Size Range (NPS)	4" x 6"	4" x 6"	4" x 6"	6" x 8"
6. Inlet/Outlet end connection	ASME B16.5, RF x ASME B16.5, RF	ASME B16.5, RF x ASME B16.5, RF	ASME B16.5, RF x ASME B16.5, RF	ASME B16.5, RF x ASME B16.5, RF
7. Inlet/Outlet pressure class	150 x 150	150 x 150	150 x 150	150 x 150
8. Temperature	-50°C to 110°C	-50°C to 110°C	-50°C to 110°C	-50°C to 110°C
9. Material Class	Duplex Steel	Duplex Steel	Duplex Steel	Duplex Steel
10. Body and bonnet Material	ASTM A995 Gr 6a	ASTM A995 Gr 6a	ASTM A995 Gr 6a	ASTM A995 Gr 6a
11. Disc Material	ASTM A479 (UNS S32760)	ASTM A479 (UNS S32760)	ASTM A479 (UNS S32760)	ASTM A479 (UNS S32760)
12. Nozzle Material	ASTM A479 (UNS S32760)	ASTM A479 (UNS S32760)	ASTM A479 (UNS S32760)	ASTM A479 (UNS S32760)
13. Guide Material	AISI 316	AISI 316	AISI 316	AISI 316
14. Spindle Material	Martensitic SS 400 Series	Martensitic SS 400 Series	Martensitic SS 400 Series	Martensitic SS 400 Series
15. Spring Material	UNS N07750	UNS N07750	UNS N07750	UNS N07750
16. Bellow Material	UNS N06625	UNS N06625	UNS N06625	UNS N06625
17. Valve Testing	API 527	API 527	API 527	API 527
18. Notes	Not Applicable	Not Applicable	Not Applicable	Not Applicable

Valve Code	PSV-BB-2-D31R	PSV-BB-2-D31T	PSV-BB-2-N11D	PSV-BB-2-N11E
Specs	B12	B12	B30	B30
1. Valve Type	Balanced	Balanced	Balanced	Balanced
2. Orifice Size	Orifice R (16.00 in ²)	Orifice T (26.00 in ²)	Orifice D (A=0.110 in ²)	Orifice E (0.196 in ²)
3. Valve Specification Level (VSL)	VSL-2	VSL-2	VSL-2	VSL-2
4. Standard	API 520	API 520	API 520	API 520
5. Inlet/Outlet Size Range (NPS)	6" x 8"	8" x 10"	1" x 2"	1" x 2"
6. Inlet/Outlet end connection	ASME B16.5, RF x ASME B16.5, RF	ASME B16.5, RF x ASME B16.5, RF	ASME B16.5, RF x ASME B16.5, RF	ASME B16.5, RF x ASME B16.5, RF
7. Inlet/Outlet pressure class	150 x 150	150 x 150	150 x 150	150 x 150
8. Temperature	-50°C to 110°C	-50°C to 110°C	-100°C to 155°C	-100°C to 155°C
9. Material Class	Duplex Steel	Duplex Steel	Nickel Alloys	Nickel Alloys
10. Body and bonnet Material	ASTM A995 Gr 6a	ASTM A995 Gr 6a	UNS N06625	UNS N06625
11. Disc Material	ASTM A479 (UNS S32760)	ASTM A479 (UNS S32760)	UNS N06625	UNS N06625
12. Nozzle Material	ASTM A479 (UNS S32760)	ASTM A479 (UNS S32760)	ASTM B564 (UNS N06625)	ASTM B564 (UNS N06625)
13. Guide Material	AISI 316	AISI 316	AISI 316	AISI 316
14. Spindle Material	Martensitic SS 400 Series	Martensitic SS 400 Series	Martensitic SS 400 Series	Martensitic SS 400 Series
15. Spring Material	UNS N07750	UNS N07750	UNS N07750	UNS N07750
16. Bellow Material	UNS N06625	UNS N06625	UNS N06625	UNS N06625
17. Valve Testing	API 527	API 527	API 527	API 527
18. Notes	Not Applicable	Not Applicable	Not Applicable	Not Applicable

Valve Code	PSV-BB-2-N11F	PSV-BB-2-N11G	PSV-BB-2-N11H	PSV-BB-2-N11J
Specs	B30	B30	B30	B30
1. Valve Type	Balanced	Balanced	Balanced	Balanced
2. Orifice Size	Orifice F (0.307 in ²)	Orifice G (0.503 in ²)	Orifice H (0.785 in ²)	Orifice J (1.287 in ²)
3. Valve Specification Level (VSL)	VSL-2	VSL-2	VSL-2	VSL-2
4. Standard	API 520	API 520	API 520	API 520
5. Inlet/Outlet Size Range (NPS)	1 ½" x 2"	1 ½" x 3"	1 ½" x 3"	2" x 3"
6. Inlet/Outlet end connection	ASME B16.5, RF x ASME B16.5, RF	ASME B16.5, RF x ASME B16.5, RF	ASME B16.5, RF x ASME B16.5, RF	ASME B16.5, RF x ASME B16.5, RF
7. Inlet/Outlet pressure class	150 x 150	150 x 150	150 x 150	150 x 150
8. Temperature	-100°C to 155°C	-100°C to 155°C	-100°C to 155°C	-100°C to 155°C
9. Material Class	Nickel Alloys	Nickel Alloys	Nickel Alloys	Nickel Alloys
10. Body and bonnet Material	UNS N06625	UNS N06625	UNS N06625	UNS N06625
11. Disc Material	UNS N06625	UNS N06625	UNS N06625	UNS N06625
12. Nozzle Material	ASTM B564 (UNS N06625)	ASTM B564 (UNS N06625)	ASTM B564 (UNS N06625)	ASTM B564 (UNS N06625)
13. Guide Material	AISI 316	AISI 316	AISI 316	AISI 316
14. Spindle Material	Martensitic SS 400 Series	Martensitic SS 400 Series	Martensitic SS 400 Series	Martensitic SS 400 Series
15. Spring Material	UNS N07750	UNS N07750	UNS N07750	UNS N07750
16. Bellow Material	UNS N06625	UNS N06625	UNS N06625	UNS N06625
17. Valve Testing	API 527	API 527	API 527	API 527
18. Notes	Not Applicable	Not Applicable	Not Applicable	Not Applicable

Valve Code	PSV-BB-2-N11K	PSV-BB-2-N11L	PSV-BB-2-N11M	PSV-BB-2-N11N
Specs	B30	B30	B30	B30
1. Valve Type	Balanced	Balanced	Balanced	Balanced
2. Orifice Size	Orifice K (1.838 in ²)	Orifice L (2.853 in ²)	Orifice M (3.60 in ²)	Orifice N (4.34 in ²)
3. Valve Specification Level (VSL)	VSL-2	VSL-2	VSL-2	VSL-2
4. Standard	API 520	API 520	API 520	API 520
5. Inlet/Outlet Size Range (NPS)	3" x 4"	3" x 4"	4" x 6"	4" x 6"
6. Inlet/Outlet end connection	ASME B16.5, RF x ASME B16.5, RF	ASME B16.5, RF x ASME B16.5, RF	ASME B16.5, RF x ASME B16.5, RF	ASME B16.5, RF x ASME B16.5, RF
7. Inlet/Outlet pressure class	150 x 150	150 x 150	150 x 150	150 x 150
8. Temperature	-100°C to 155°C	-100°C to 155°C	-100°C to 155°C	-100°C to 155°C
9. Material Class	Nickel Alloys	Nickel Alloys	Nickel Alloys	Nickel Alloys
10. Body and bonnet Material	UNS N06625	UNS N06625	UNS N06625	UNS N06625
11. Disc Material	UNS N06625	UNS N06625	UNS N06625	UNS N06625
12. Nozzle Material	ASTM B564 (UNS N06625)	ASTM B564 (UNS N06625)	ASTM B564 (UNS N06625)	ASTM B564 (UNS N06625)
13. Guide Material	AISI 316	AISI 316	AISI 316	AISI 316
14. Spindle Material	Martensitic SS 400 Series	Martensitic SS 400 Series	Martensitic SS 400 Series	Martensitic SS 400 Series
15. Spring Material	UNS N07750	UNS N07750	UNS N07750	UNS N07750
16. Bellow Material	UNS N06625	UNS N06625	UNS N06625	UNS N06625
17. Valve Testing	API 527	API 527	API 527	API 527
18. Notes	Not Applicable	Not Applicable	Not Applicable	Not Applicable

Valve Code	PSV-BB-2-N11P	PSV-BB-2-N11Q	PSV-BB-2-N11R	PSV-BB-2-N11T
Specs	B30	B30	B30	B30
1. Valve Type	Balanced	Balanced	Balanced	Balanced
2. Orifice Size	Orifice P (6.38 in ²)	Orifice Q (11.05 in ²)	Orifice R (16.00 in ²)	Orifice T (26.00 in ²)
3. Valve Specification Level (VSL)	VSL-2	VSL-2	VSL-2	VSL-2
4. Standard	API 520	API 520	API 520	API 520
5. Inlet/Outlet Size Range (NPS)	4" x 6"	6" x 8"	6" x 8"	8" x 10"
6. Inlet/Outlet end connection	ASME B16.5, RF x ASME B16.5, RF	ASME B16.5, RF x ASME B16.5, RF	ASME B16.5, RF x ASME B16.5, RF	ASME B16.5, RF x ASME B16.5, RF
7. Inlet/Outlet pressure class	150 x 150	150 x 150	150 x 150	150 x 150
8. Temperature	-100°C to 155°C	-100°C to 155°C	-100°C to 155°C	-100°C to 155°C
9. Material Class	Nickel Alloys	Nickel Alloys	Nickel Alloys	Nickel Alloys
10. Body and bonnet Material	UNS N06625	UNS N06625	UNS N06625	UNS N06625
11. Disc Material	UNS N06625	UNS N06625	UNS N06625	UNS N06625
12. Nozzle Material	ASTM B564 (UNS N06625)	ASTM B564 (UNS N06625)	ASTM B564 (UNS N06625)	ASTM B564 (UNS N06625)
13. Guide Material	AISI 316	AISI 316	AISI 316	AISI 316
14. Spindle Material	Martensitic SS 400 Series	Martensitic SS 400 Series	Martensitic SS 400 Series	Martensitic SS 400 Series
15. Spring Material	UNS N07750	UNS N07750	UNS N07750	UNS N07750
16. Bellow Material	UNS N06625	UNS N06625	UNS N06625	UNS N06625
17. Valve Testing	API 527	API 527	API 527	API 527
18. Notes	Not Applicable	Not Applicable	Not Applicable	Not Applicable

Valve Code	PSV-BB-2-S21D	PSV-BB-2-S21E	PSV-BB-2-S21F	PSV-BB-2-S21G
Specs	B3 B6 B9 B10 B19	B3 B6 B9 B10 B19	B3 B6 B9 B10 B19	B3 B6 B9 B10 B19
1. Valve Type	Balanced	Balanced	Balanced	Balanced
2. Orifice Size	Orifice D (A=0.110 in ²)	Orifice E (0.196 in ²)	Orifice F (0.307 in ²)	Orifice G (0.503 in ²)
3. Valve Specification Level (VSL)	VSL-2	VSL-2	VSL-2	VSL-2
4. Standard	API 520	API 520	API 520	API 520
5. Inlet/Outlet Size Range (NPS)	1" x 2"	1" x 2"	1 ½" x 2"	1 ½" x 3"
6. Inlet/Outlet end connection	ASME B16.5, RF x ASME B16.5, RF	ASME B16.5, RF x ASME B16.5, RF	ASME B16.5, RF x ASME B16.5, RF	ASME B16.5, RF x ASME B16.5, RF
7. Inlet/Outlet pressure class	150 x 150	150 x 150	150 x 150	150 x 150
8. Temperature	-100°C to 260°C	-100°C to 260°C	-100°C to 260°C	-100°C to 260°C
9. Material Class	Stainless Steel	Stainless Steel	Stainless Steel	Stainless Steel
10. Body and bonnet Material	ASTM A182 Gr CF8M	ASTM A182 Gr CF8M	ASTM A182 Gr CF8M	ASTM A182 Gr CF8M
11. Disc Material	AISI 316 + Stellite	AISI 316 + Stellite	AISI 316 + Stellite	AISI 316 + Stellite
12. Nozzle Material	AISI 316	AISI 316	AISI 316	AISI 316
13. Guide Material	AISI 316	AISI 316	AISI 316	AISI 316
14. Spindle Material	Martensitic SS 400 Series	Martensitic SS 400 Series	Martensitic SS 400 Series	Martensitic SS 400 Series
15. Spring Material	UNS N07750	UNS N07750	UNS N07750	UNS N07750
16. Bellow Material	UNS N06625	UNS N06625	UNS N06625	UNS N06625
17. Valve Testing	API 527	API 527	API 527	API 527
18. Notes	Not Applicable	Not Applicable	Not Applicable	Not Applicable

Valve Code	PSV-BB-2-S21H	PSV-BB-2-S21J	PSV-BB-2-S21K	PSV-BB-2-S21L
Specs	B3 B6 B9 B10 B19	B3 B6 B9 B10 B19	B3 B6 B9 B10 B19	B3 B6 B9 B10 B19
1. Valve Type	Balanced	Balanced	Balanced	Balanced
2. Orifice Size	Orifice H (0.785 in ²)	Orifice J (1.287 in ²)	Orifice K (1.838 in ²)	Orifice L (2.853 in ²)
3. Valve Specification Level (VSL)	VSL-2	VSL-2	VSL-2	VSL-2
4. Standard	API 520	API 520	API 520	API 520
5. Inlet/Outlet Size Range (NPS)	1 ½" x 3"	2" x 3"	3" x 4"	3" x 4"
6. Inlet/Outlet end connection	ASME B16.5, RF x ASME B16.5, RF	ASME B16.5, RF x ASME B16.5, RF	ASME B16.5, RF x ASME B16.5, RF	ASME B16.5, RF x ASME B16.5, RF
7. Inlet/Outlet pressure class	150 x 150	150 x 150	150 x 150	150 x 150
8. Temperature	-100°C to 260°C	-100°C to 260°C	-100°C to 260°C	-100°C to 260°C
9. Material Class	Stainless Steel	Stainless Steel	Stainless Steel	Stainless Steel
10. Body and bonnet Material	ASTM A182 Gr CF8M	ASTM A182 Gr CF8M	ASTM A182 Gr CF8M	ASTM A182 Gr CF8M
11. Disc Material	AISI 316 + Stellite	AISI 316 + Stellite	AISI 316 + Stellite	AISI 316 + Stellite
12. Nozzle Material	AISI 316	AISI 316	AISI 316	AISI 316
13. Guide Material	AISI 316	AISI 316	AISI 316	AISI 316
14. Spindle Material	Martensitic SS 400 Series	Martensitic SS 400 Series	Martensitic SS 400 Series	Martensitic SS 400 Series
15. Spring Material	UNS N07750	UNS N07750	UNS N07750	UNS N07750
16. Bellow Material	UNS N06625	UNS N06625	UNS N06625	UNS N06625
17. Valve Testing	API 527	API 527	API 527	API 527
18. Notes	Not Applicable	Not Applicable	Not Applicable	Not Applicable

Valve Code	PSV-BB-2-S21M	PSV-BB-2-S21N	PSV-BB-2-S21P	PSV-BB-2-S21Q
Specs	B3 B6 B9 B10 B19	B3 B6 B9 B10 B19	B3 B6 B9 B10 B19	B3 B6 B9 B10 B19
1. Valve Type	Balanced	Balanced	Balanced	Balanced
2. Orifice Size	Orifice M (3.60 in ²)	Orifice N (4.34 in ²)	Orifice P (6.38 in ²)	Orifice Q (11.05 in ²)
3. Valve Specification Level (VSL)	VSL-2	VSL-2	VSL-2	VSL-2
4. Standard	API 520	API 520	API 520	API 520
5. Inlet/Outlet Size Range (NPS)	4" x 6"	4" x 6"	4" x 6"	6" x 8"
6. Inlet/Outlet end connection	ASME B16.5, RF x ASME B16.5, RF	ASME B16.5, RF x ASME B16.5, RF	ASME B16.5, RF x ASME B16.5, RF	ASME B16.5, RF x ASME B16.5, RF
7. Inlet/Outlet pressure class	150 x 150	150 x 150	150 x 150	150 x 150
8. Temperature	-100°C to 260°C	-100°C to 260°C	-100°C to 260°C	-100°C to 260°C
9. Material Class	Stainless Steel	Stainless Steel	Stainless Steel	Stainless Steel
10. Body and bonnet Material	ASTM A182 Gr CF8M	ASTM A182 Gr CF8M	ASTM A182 Gr CF8M	ASTM A182 Gr CF8M
11. Disc Material	AISI 316 + Stellite	AISI 316 + Stellite	AISI 316 + Stellite	AISI 316 + Stellite
12. Nozzle Material	AISI 316	AISI 316	AISI 316	AISI 316
13. Guide Material	AISI 316	AISI 316	AISI 316	AISI 316
14. Spindle Material	Martensitic SS 400 Series	Martensitic SS 400 Series	Martensitic SS 400 Series	Martensitic SS 400 Series
15. Spring Material	UNS N07750	UNS N07750	UNS N07750	UNS N07750
16. Bellow Material	UNS N06625	UNS N06625	UNS N06625	UNS N06625
17. Valve Testing	API 527	API 527	API 527	API 527
18. Notes	Not Applicable	Not Applicable	Not Applicable	Not Applicable

Valve Code	PSV-BB-2-S21R	PSV-BB-2-S21T	PSV-CB-1-C10D	PSV-CB-1-C10E
Specs	B3 B6 B9 B10 B19	B3 B6 B9 B10 B19	C4 C9 C10	C4 C9 C10
1. Valve Type	Balanced	Balanced	Conventional	Conventional
2. Orifice Size	Orifice R (16.00 in ²)	Orifice T (26.00 in ²)	Orifice D (A=0.110 in ²)	Orifice E (0.196 in ²)
3. Valve Specification Level (VSL)	VSL-2	VSL-2	VSL-1	VSL-1
4. Standard	API 520	API 520	API 520	API 520
5. Inlet/Outlet Size Range (NPS)	6" x 8"	8" x 10"	1" x 2"	1" x 2"
6. Inlet/Outlet end connection	ASME B16.5, RF x ASME B16.5, RF	ASME B16.5, RF x ASME B16.5, RF	ASME B16.5, RF x ASME B16.5, RF	ASME B16.5, RF x ASME B16.5, RF
7. Inlet/Outlet pressure class	150 x 150	150 x 150	300 x 150	300 x 150
8. Temperature	-100°C to 260°C	-100°C to 260°C	0°C to 240°C	0°C to 240°C
9. Material Class	Stainless Steel	Stainless Steel	Carbon Steel	Carbon Steel
10. Body and bonnet Material	ASTM A182 Gr CF8M	ASTM A182 Gr CF8M	ASTM A216 Gr WCB	ASTM A216 Gr WCB
11. Disc Material	AISI 316 + Stellite	AISI 316 + Stellite	Martensitic SS 400 Series	Martensitic SS 400 Series
12. Nozzle Material	AISI 316	AISI 316	AISI 316	AISI 316
13. Guide Material	AISI 316	AISI 316	AISI 316	AISI 316
14. Spindle Material	Martensitic SS 400 Series	Martensitic SS 400 Series	Martensitic SS 400 Series	Martensitic SS 400 Series
15. Spring Material	UNS N07750	UNS N07750	UNS N07750	UNS N07750
16. Bellow Material	UNS N06625	UNS N06625	Not applicable	Not applicable
17. Valve Testing	API 527	API 527	API 527	API 527
18. Notes	Not Applicable	Not Applicable	Not Applicable	Not Applicable

Valve Code	PSV-CB-1-C10F	PSV-CB-1-C10G	PSV-CB-1-C10H	PSV-CB-1-C10J
Specs	C4 C9 C10	C4 C9 C10	C4 C9 C10	C4 C9 C10
1. Valve Type	Conventional	Conventional	Conventional	Conventional
2. Orifice Size	Orifice F (0.307 in ²)	Orifice G (0.503 in ²)	Orifice H (0.785 in ²)	Orifice J (1.287 in ²)
3. Valve Specification Level (VSL)	VSL-1	VSL-1	VSL-1	VSL-1
4. Standard	API 520	API 520	API 520	API 520
5. Inlet/Outlet Size Range (NPS)	1 ½" x 2"	1 ½" x 3"	2" x 3"	3" x 4"
6. Inlet/Outlet end connection	ASME B16.5, RF x ASME B16.5, RF	ASME B16.5, RF x ASME B16.5, RF	ASME B16.5, RF x ASME B16.5, RF	ASME B16.5, RF x ASME B16.5, RF
7. Inlet/Outlet pressure class	300 x 150	300 x 150	300 x 150	300 x 150
8. Temperature	0°C to 240°C	0°C to 240°C	0°C to 240°C	0°C to 240°C
9. Material Class	Carbon Steel	Carbon Steel	Carbon Steel	Carbon Steel
10. Body and bonnet Material	ASTM A216 Gr WCB	ASTM A216 Gr WCB	ASTM A216 Gr WCB	ASTM A216 Gr WCB
11. Disc Material	Martensitic SS 400 Series	Martensitic SS 400 Series	Martensitic SS 400 Series	Martensitic SS 400 Series
12. Nozzle Material	AISI 316	AISI 316	AISI 316	AISI 316
13. Guide Material	AISI 316	AISI 316	AISI 316	AISI 316
14. Spindle Material	Martensitic SS 400 Series	Martensitic SS 400 Series	Martensitic SS 400 Series	Martensitic SS 400 Series
15. Spring Material	UNS N07750	UNS N07750	UNS N07750	UNS N07750
16. Bellow Material	Not applicable	Not applicable	Not applicable	Not applicable
17. Valve Testing	API 527	API 527	API 527	API 527
18. Notes	Not Applicable	Not Applicable	Not Applicable	Not Applicable

Valve Code	PSV-CB-1-C10K	PSV-CB-1-C10L	PSV-CB-1-C10M	PSV-CB-1-C10N
Specs	C4 C9 C10	C4 C9 C10	C4 C9 C10	C4 C9 C10
1. Valve Type	Conventional	Conventional	Conventional	Conventional
2. Orifice Size	Orifice K (1.838 in ²)	Orifice L (2.853 in ²)	Orifice M (3.60 in ²)	Orifice N (4.34 in ²)
3. Valve Specification Level (VSL)	VSL-1	VSL-1	VSL-1	VSL-1
4. Standard	API 520	API 520	API 520	API 520
5. Inlet/Outlet Size Range (NPS)	3" x 4"	4" x 6"	4" x 6"	4" x 6"
6. Inlet/Outlet end connection	ASME B16.5, RF x ASME B16.5, RF	ASME B16.5, RF x ASME B16.5, RF	ASME B16.5, RF x ASME B16.5, RF	ASME B16.5, RF x ASME B16.5, RF
7. Inlet/Outlet pressure class	300 x 150	300 x 150	300 x 150	300 x 150
8. Temperature	0°C to 240°C	0°C to 240°C	0°C to 240°C	0°C to 240°C
9. Material Class	Carbon Steel	Carbon Steel	Carbon Steel	Carbon Steel
10. Body and bonnet Material	ASTM A216 Gr WCB	ASTM A216 Gr WCB	ASTM A216 Gr WCB	ASTM A216 Gr WCB
11. Disc Material	Martensitic SS 400 Series	Martensitic SS 400 Series	Martensitic SS 400 Series	Martensitic SS 400 Series
12. Nozzle Material	AISI 316	AISI 316	AISI 316	AISI 316
13. Guide Material	AISI 316	AISI 316	AISI 316	AISI 316
14. Spindle Material	Martensitic SS 400 Series	Martensitic SS 400 Series	Martensitic SS 400 Series	Martensitic SS 400 Series
15. Spring Material	UNS N07750	UNS N07750	UNS N07750	UNS N07750
16. Bellow Material	Not applicable	Not applicable	Not applicable	Not applicable
17. Valve Testing	API 527	API 527	API 527	API 527
18. Notes	Not Applicable	Not Applicable	Not Applicable	Not Applicable

Valve Code	PSV-CB-1-C10P	PSV-CB-1-C10Q	PSV-CB-1-C10R	PSV-CB-1-C10T
Specs	C4 C9 C10	C4 C9 C10	C4 C9 C10	C4 C9 C10
1. Valve Type	Conventional	Conventional	Conventional	Conventional
2. Orifice Size	Orifice P (6.38 in ²)	Orifice Q (11.05 in ²)	Orifice R (16.00 in ²)	Orifice T (26.00 in ²)
3. Valve Specification Level (VSL)	VSL-1	VSL-1	VSL-1	VSL-1
4. Standard	API 520	API 520	API 520	API 520
5. Inlet/Outlet Size Range (NPS)	4" x 6"	6" x 8"	6" x 10"	8" x 10"
6. Inlet/Outlet end connection	ASME B16.5, RF x ASME B16.5, RF	ASME B16.5, RF x ASME B16.5, RF	ASME B16.5, RF x ASME B16.5, RF	ASME B16.5, RF x ASME B16.5, RF
7. Inlet/Outlet pressure class	300 x 150	300 x 150	300 x 150	300 x 150
8. Temperature	0°C to 240°C	0°C to 240°C	0°C to 240°C	0°C to 240°C
9. Material Class	Carbon Steel	Carbon Steel	Carbon Steel	Carbon Steel
10. Body and bonnet Material	ASTM A216 Gr WCB	ASTM A216 Gr WCB	ASTM A216 Gr WCB	ASTM A216 Gr WCB
11. Disc Material	Martensitic SS 400 Series	Martensitic SS 400 Series	Martensitic SS 400 Series	Martensitic SS 400 Series
12. Nozzle Material	AISI 316	AISI 316	AISI 316	AISI 316
13. Guide Material	AISI 316	AISI 316	AISI 316	AISI 316
14. Spindle Material	Martensitic SS 400 Series	Martensitic SS 400 Series	Martensitic SS 400 Series	Martensitic SS 400 Series
15. Spring Material	UNS N07750	UNS N07750	UNS N07750	UNS N07750
16. Bellow Material	Not applicable	Not applicable	Not applicable	Not applicable
17. Valve Testing	API 527	API 527	API 527	API 527
18. Notes	Not Applicable	Not Applicable	Not Applicable	Not Applicable

Valve Code	PSV-CB-1-C11D	PSV-CB-1-C11E	PSV-CB-1-C11F	PSV-CB-1-C11G
Specs	C4 C9 C10	C4 C9 C10	C4 C9 C10	C4 C9 C10
1. Valve Type	Balanced	Balanced	Balanced	Balanced
2. Orifice Size	Orifice D (A=0.110 in ²)	Orifice E (0.196 in ²)	Orifice F (0.307 in ²)	Orifice G (0.503 in ²)
3. Valve Specification Level (VSL)	VSL-1	VSL-1	VSL-1	VSL-1
4. Standard	API 520	API 520	API 520	API 520
5. Inlet/Outlet Size Range (NPS)	1" x 2"	1" x 2"	1 ½" x 2"	1 ½" x 3"
6. Inlet/Outlet end connection	ASME B16.5, RF x ASME B16.5, RF	ASME B16.5, RF x ASME B16.5, RF	ASME B16.5, RF x ASME B16.5, RF	ASME B16.5, RF x ASME B16.5, RF
7. Inlet/Outlet pressure class	300 x 150	300 x 150	300 x 150	300 x 150
8. Temperature	0°C to 240°C	0°C to 240°C	0°C to 240°C	0°C to 240°C
9. Material Class	Carbon Steel	Carbon Steel	Carbon Steel	Carbon Steel
10. Body and bonnet Material	ASTM A216 Gr WCB	ASTM A216 Gr WCB	ASTM A216 Gr WCB	ASTM A216 Gr WCB
11. Disc Material	Martensitic SS 400 Series	Martensitic SS 400 Series	Martensitic SS 400 Series	Martensitic SS 400 Series
12. Nozzle Material	AISI 316	AISI 316	AISI 316	AISI 316
13. Guide Material	AISI 316	AISI 316	AISI 316	AISI 316
14. Spindle Material	Martensitic SS 400 Series	Martensitic SS 400 Series	Martensitic SS 400 Series	Martensitic SS 400 Series
15. Spring Material	UNS N07750	UNS N07750	UNS N07750	UNS N07750
16. Bellow Material	UNS N06625	UNS N06625	UNS N06625	UNS N06625
17. Valve Testing	API 527	API 527	API 527	API 527
18. Notes	Not Applicable	Not Applicable	Not Applicable	Not Applicable

Valve Code	PSV-CB-1-C11H	PSV-CB-1-C11J	PSV-CB-1-C11K	PSV-CB-1-C11L
Specs	C4 C9 C10	C4 C9 C10	C4 C9 C10	C4 C9 C10
1. Valve Type	Balanced	Balanced	Balanced	Balanced
2. Orifice Size	Orifice H (0.785 in ²)	Orifice J (1.287 in ²)	Orifice K (1.838 in ²)	Orifice L (2.853 in ²)
3. Valve Specification Level (VSL)	VSL-1	VSL-1	VSL-1	VSL-1
4. Standard	API 520	API 520	API 520	API 520
5. Inlet/Outlet Size Range (NPS)	2" x 3"	3" x 4"	3" x 4"	4" x 6"
6. Inlet/Outlet end connection	ASME B16.5, RF x ASME B16.5, RF	ASME B16.5, RF x ASME B16.5, RF	ASME B16.5, RF x ASME B16.5, RF	ASME B16.5, RF x ASME B16.5, RF
7. Inlet/Outlet pressure class	300 x 150	300 x 150	300 x 150	300 x 150
8. Temperature	0°C to 240°C	0°C to 240°C	0°C to 240°C	0°C to 240°C
9. Material Class	Carbon Steel	Carbon Steel	Carbon Steel	Carbon Steel
10. Body and bonnet Material	ASTM A216 Gr WCB	ASTM A216 Gr WCB	ASTM A216 Gr WCB	ASTM A216 Gr WCB
11. Disc Material	Martensitic SS 400 Series	Martensitic SS 400 Series	Martensitic SS 400 Series	Martensitic SS 400 Series
12. Nozzle Material	AISI 316	AISI 316	AISI 316	AISI 316
13. Guide Material	AISI 316	AISI 316	AISI 316	AISI 316
14. Spindle Material	Martensitic SS 400 Series	Martensitic SS 400 Series	Martensitic SS 400 Series	Martensitic SS 400 Series
15. Spring Material	UNS N07750	UNS N07750	UNS N07750	UNS N07750
16. Bellow Material	UNS N06625	UNS N06625	UNS N06625	UNS N06625
17. Valve Testing	API 527	API 527	API 527	API 527
18. Notes	Not Applicable	Not Applicable	Not Applicable	Not Applicable

Valve Code	PSV-CB-1-C11M	PSV-CB-1-C11N	PSV-CB-1-C11P	PSV-CB-1-C11Q
Specs	C4 C9 C10	C4 C9 C10	C4 C9 C10	C4 C9 C10
1. Valve Type	Balanced	Balanced	Balanced	Balanced
2. Orifice Size	Orifice M (3.60 in ²)	Orifice N (4.34 in ²)	Orifice P (6.38 in ²)	Orifice Q (11.05 in ²)
3. Valve Specification Level (VSL)	VSL-1	VSL-1	VSL-1	VSL-1
4. Standard	API 520	API 520	API 520	API 520
5. Inlet/Outlet Size Range (NPS)	4" x 6"	4" x 6"	4" x 6"	6" x 8"
6. Inlet/Outlet end connection	ASME B16.5, RF x ASME B16.5, RF	ASME B16.5, RF x ASME B16.5, RF	ASME B16.5, RF x ASME B16.5, RF	ASME B16.5, RF x ASME B16.5, RF
7. Inlet/Outlet pressure class	300 x 150	300 x 150	300 x 150	300 x 150
8. Temperature	0°C to 240°C	0°C to 240°C	0°C to 240°C	0°C to 240°C
9. Material Class	Carbon Steel	Carbon Steel	Carbon Steel	Carbon Steel
10. Body and bonnet Material	ASTM A216 Gr WCB	ASTM A216 Gr WCB	ASTM A216 Gr WCB	ASTM A216 Gr WCB
11. Disc Material	Martensitic SS 400 Series	Martensitic SS 400 Series	Martensitic SS 400 Series	Martensitic SS 400 Series
12. Nozzle Material	AISI 316	AISI 316	AISI 316	AISI 316
13. Guide Material	AISI 316	AISI 316	AISI 316	AISI 316
14. Spindle Material	Martensitic SS 400 Series	Martensitic SS 400 Series	Martensitic SS 400 Series	Martensitic SS 400 Series
15. Spring Material	UNS N07750	UNS N07750	UNS N07750	UNS N07750
16. Bellow Material	UNS N06625	UNS N06625	UNS N06625	UNS N06625
17. Valve Testing	API 527	API 527	API 527	API 527
18. Notes	Not Applicable	Not Applicable	Not Applicable	Not Applicable

Valve Code	PSV-CB-1-C11R	PSV-CB-1-C11T	PSV-CB-1-C20D	PSV-CB-1-C20E
Specs	C4 C9 C10	C4 C9 C10	C6 C9 C10 C19	C6 C9 C10 C19
1. Valve Type	Balanced	Balanced	Conventional	Conventional
2. Orifice Size	Orifice R (16.00 in ²)	Orifice T (26.00 in ²)	Orifice D (A=0.110 in ²)	Orifice E (0.196 in ²)
3. Valve Specification Level (VSL)	VSL-1	VSL-1	VSL-1	VSL-1
4. Standard	API 520	API 520	API 520	API 520
5. Inlet/Outlet Size Range (NPS)	6" x 10"	8" x 10"	1" x 2"	1" x 2"
6. Inlet/Outlet end connection	ASME B16.5, RF x ASME B16.5, RF	ASME B16.5, RF x ASME B16.5, RF	ASME B16.5, RF x ASME B16.5, RF	ASME B16.5, RF x ASME B16.5, RF
7. Inlet/Outlet pressure class	300 x 150	300 x 150	300 x 150	300 x 150
8. Temperature	0°C to 240°C	0°C to 240°C	-46°C to 240°C	-46°C to 240°C
9. Material Class	Carbon Steel	Carbon Steel	Carbon Steel	Carbon Steel
10. Body and bonnet Material	ASTM A216 Gr WCB	ASTM A216 Gr WCB	ASTM A352 Gr LCB	ASTM A352 Gr LCB
11. Disc Material	Martensitic SS 400 Series	Martensitic SS 400 Series	AISI 316 + Stellite	AISI 316 + Stellite
12. Nozzle Material	AISI 316	AISI 316	AISI 316	AISI 316
13. Guide Material	AISI 316	AISI 316	AISI 316	AISI 316
14. Spindle Material	Martensitic SS 400 Series	Martensitic SS 400 Series	Martensitic SS 400 Series	Martensitic SS 400 Series
15. Spring Material	UNS N07750	UNS N07750	UNS N07750	UNS N07750
16. Bellow Material	UNS N06625	UNS N06625	Not applicable	Not applicable
17. Valve Testing	API 527	API 527	API 527	API 527
18. Notes	Not Applicable	Not Applicable	Not Applicable	Not Applicable

Valve Code	PSV-CB-1-C20F	PSV-CB-1-C20G	PSV-CB-1-C20H	PSV-CB-1-C20J
Specs	C6 C9 C10 C19	C6 C9 C10 C19	C6 C9 C10 C19	C6 C9 C10 C19
1. Valve Type	Conventional	Conventional	Conventional	Conventional
2. Orifice Size	Orifice F (0.307 in ²)	Orifice G (0.503 in ²)	Orifice H (0.785 in ²)	Orifice J (1.287 in ²)
3. Valve Specification Level (VSL)	VSL-1	VSL-1	VSL-1	VSL-1
4. Standard	API 520	API 520	API 520	API 520
5. Inlet/Outlet Size Range (NPS)	1 ½" x 2"	1 ½" x 3"	2" x 3"	3" x 4"
6. Inlet/Outlet end connection	ASME B16.5, RF x ASME B16.5, RF	ASME B16.5, RF x ASME B16.5, RF	ASME B16.5, RF x ASME B16.5, RF	ASME B16.5, RF x ASME B16.5, RF
7. Inlet/Outlet pressure class	300 x 150	300 x 150	300 x 150	300 x 150
8. Temperature	-46°C to 240°C	-46°C to 240°C	-46°C to 240°C	-46°C to 240°C
9. Material Class	Carbon Steel	Carbon Steel	Carbon Steel	Carbon Steel
10. Body and bonnet Material	ASTM A352 Gr LCB	ASTM A352 Gr LCB	ASTM A352 Gr LCB	ASTM A352 Gr LCB
11. Disc Material	AISI 316 + Stellite	AISI 316 + Stellite	AISI 316 + Stellite	AISI 316 + Stellite
12. Nozzle Material	AISI 316	AISI 316	AISI 316	AISI 316
13. Guide Material	AISI 316	AISI 316	AISI 316	AISI 316
14. Spindle Material	Martensitic SS 400 Series	Martensitic SS 400 Series	Martensitic SS 400 Series	Martensitic SS 400 Series
15. Spring Material	UNS N07750	UNS N07750	UNS N07750	UNS N07750
16. Bellow Material	Not applicable	Not applicable	Not applicable	Not applicable
17. Valve Testing	API 527	API 527	API 527	API 527
18. Notes	Not Applicable	Not Applicable	Not Applicable	Not Applicable

Valve Code	PSV-CB-1-C20K	PSV-CB-1-C20L	PSV-CB-1-C20M	PSV-CB-1-C20N
Specs	C6 C9 C10 C19	C6 C9 C10 C19	C6 C9 C10 C19	C6 C9 C10 C19
1. Valve Type	Conventional	Conventional	Conventional	Conventional
2. Orifice Size	Orifice K (1.838 in ²)	Orifice L (2.853 in ²)	Orifice M (3.60 in ²)	Orifice N (4.34 in ²)
3. Valve Specification Level (VSL)	VSL-1	VSL-1	VSL-1	VSL-1
4. Standard	API 520	API 520	API 520	API 520
5. Inlet/Outlet Size Range (NPS)	3" x 4"	4" x 6"	4" x 6"	4" x 6"
6. Inlet/Outlet end connection	ASME B16.5, RF x ASME B16.5, RF	ASME B16.5, RF x ASME B16.5, RF	ASME B16.5, RF x ASME B16.5, RF	ASME B16.5, RF x ASME B16.5, RF
7. Inlet/Outlet pressure class	300 x 150	300 x 150	300 x 150	300 x 150
8. Temperature	-46°C to 240°C	-46°C to 240°C	-46°C to 240°C	-46°C to 240°C
9. Material Class	Carbon Steel	Carbon Steel	Carbon Steel	Carbon Steel
10. Body and bonnet Material	ASTM A352 Gr LCB	ASTM A352 Gr LCB	ASTM A352 Gr LCB	ASTM A352 Gr LCB
11. Disc Material	AISI 316 + Stellite	AISI 316 + Stellite	AISI 316 + Stellite	AISI 316 + Stellite
12. Nozzle Material	AISI 316	AISI 316	AISI 316	AISI 316
13. Guide Material	AISI 316	AISI 316	AISI 316	AISI 316
14. Spindle Material	Martensitic SS 400 Series	Martensitic SS 400 Series	Martensitic SS 400 Series	Martensitic SS 400 Series
15. Spring Material	UNS N07750	UNS N07750	UNS N07750	UNS N07750
16. Bellow Material	Not applicable	Not applicable	Not applicable	Not applicable
17. Valve Testing	API 527	API 527	API 527	API 527
18. Notes	Not Applicable	Not Applicable	Not Applicable	Not Applicable

Valve Code	PSV-CB-1-C20P	PSV-CB-1-C20Q	PSV-CB-1-C20R	PSV-CB-1-C20T
Specs	C6 C9 C10 C19	C6 C9 C10 C19	C6 C9 C10 C19	C6 C9 C10 C19
1. Valve Type	Conventional	Conventional	Conventional	Conventional
2. Orifice Size	Orifice P (6.38 in ²)	Orifice Q (11.05 in ²)	Orifice R (16.00 in ²)	Orifice T (26.00 in ²)
3. Valve Specification Level (VSL)	VSL-1	VSL-1	VSL-1	VSL-1
4. Standard	API 520	API 520	API 520	API 520
5. Inlet/Outlet Size Range (NPS)	4" x 6"	6" x 8"	6" x 10"	8" x 10"
6. Inlet/Outlet end connection	ASME B16.5, RF x ASME B16.5, RF	ASME B16.5, RF x ASME B16.5, RF	ASME B16.5, RF x ASME B16.5, RF	ASME B16.5, RF x ASME B16.5, RF
7. Inlet/Outlet pressure class	300 x 150	300 x 150	300 x 150	300 x 150
8. Temperature	-46°C to 240°C	-46°C to 240°C	-46°C to 240°C	-46°C to 240°C
9. Material Class	Carbon Steel	Carbon Steel	Carbon Steel	Carbon Steel
10. Body and bonnet Material	ASTM A352 Gr LCB	ASTM A352 Gr LCB	ASTM A352 Gr LCB	ASTM A352 Gr LCB
11. Disc Material	AISI 316 + Stellite	AISI 316 + Stellite	AISI 316 + Stellite	AISI 316 + Stellite
12. Nozzle Material	AISI 316	AISI 316	AISI 316	AISI 316
13. Guide Material	AISI 316	AISI 316	AISI 316	AISI 316
14. Spindle Material	Martensitic SS 400 Series	Martensitic SS 400 Series	Martensitic SS 400 Series	Martensitic SS 400 Series
15. Spring Material	UNS N07750	UNS N07750	UNS N07750	UNS N07750
16. Bellow Material	Not applicable	Not applicable	Not applicable	Not applicable
17. Valve Testing	API 527	API 527	API 527	API 527
18. Notes	Not Applicable	Not Applicable	Not Applicable	Not Applicable

Valve Code	PSV-CB-1-C21D	PSV-CB-1-C21E	PSV-CB-1-C21F	PSV-CB-1-C21G
Specs	C6 C9 C10 C19	C6 C9 C10 C19	C6 C9 C10 C19	C6 C9 C10 C19
1. Valve Type	Balanced	Balanced	Balanced	Balanced
2. Orifice Size	Orifice D (A=0.110 in ²)	Orifice E (0.196 in ²)	Orifice F (0.307 in ²)	Orifice G (0.503 in ²)
3. Valve Specification Level (VSL)	VSL-1	VSL-1	VSL-1	VSL-1
4. Standard	API 520	API 520	API 520	API 520
5. Inlet/Outlet Size Range (NPS)	1" x 2"	1" x 2"	1 ½" x 2"	1 ½" x 3"
6. Inlet/Outlet end connection	ASME B16.5, RF x ASME B16.5, RF	ASME B16.5, RF x ASME B16.5, RF	ASME B16.5, RF x ASME B16.5, RF	ASME B16.5, RF x ASME B16.5, RF
7. Inlet/Outlet pressure class	300 x 150	300 x 150	300 x 150	300 x 150
8. Temperature	-46°C to 240°C	-46°C to 240°C	-46°C to 240°C	-46°C to 240°C
9. Material Class	Carbon Steel	Carbon Steel	Carbon Steel	Carbon Steel
10. Body and bonnet Material	ASTM A352 Gr LCB	ASTM A352 Gr LCB	ASTM A352 Gr LCB	ASTM A352 Gr LCB
11. Disc Material	AISI 316 + Stellite	AISI 316 + Stellite	AISI 316 + Stellite	AISI 316 + Stellite
12. Nozzle Material	AISI 316	AISI 316	AISI 316	AISI 316
13. Guide Material	AISI 316	AISI 316	AISI 316	AISI 316
14. Spindle Material	Martensitic SS 400 Series	Martensitic SS 400 Series	Martensitic SS 400 Series	Martensitic SS 400 Series
15. Spring Material	UNS N07750	UNS N07750	UNS N07750	UNS N07750
16. Bellow Material	UNS N06625	UNS N06625	UNS N06625	UNS N06625
17. Valve Testing	API 527	API 527	API 527	API 527
18. Notes	Not Applicable	Not Applicable	Not Applicable	Not Applicable

Valve Code	PSV-CB-1-C21H	PSV-CB-1-C21J	PSV-CB-1-C21K	PSV-CB-1-C21L
Specs	C6 C9 C10 C19	C6 C9 C10 C19	C6 C9 C10 C19	C6 C9 C10 C19
1. Valve Type	Balanced	Balanced	Balanced	Balanced
2. Orifice Size	Orifice H (0.785 in ²)	Orifice J (1.287 in ²)	Orifice K (1.838 in ²)	Orifice L (2.853 in ²)
3. Valve Specification Level (VSL)	VSL-1	VSL-1	VSL-1	VSL-1
4. Standard	API 520	API 520	API 520	API 520
5. Inlet/Outlet Size Range (NPS)	2" x 3"	3" x 4"	3" x 4"	4" x 6"
6. Inlet/Outlet end connection	ASME B16.5, RF x ASME B16.5, RF	ASME B16.5, RF x ASME B16.5, RF	ASME B16.5, RF x ASME B16.5, RF	ASME B16.5, RF x ASME B16.5, RF
7. Inlet/Outlet pressure class	300 x 150	300 x 150	300 x 150	300 x 150
8. Temperature	-46°C to 240°C	-46°C to 240°C	-46°C to 240°C	-46°C to 240°C
9. Material Class	Carbon Steel	Carbon Steel	Carbon Steel	Carbon Steel
10. Body and bonnet Material	ASTM A352 Gr LCB	ASTM A352 Gr LCB	ASTM A352 Gr LCB	ASTM A352 Gr LCB
11. Disc Material	AISI 316 + Stellite	AISI 316 + Stellite	AISI 316 + Stellite	AISI 316 + Stellite
12. Nozzle Material	AISI 316	AISI 316	AISI 316	AISI 316
13. Guide Material	AISI 316	AISI 316	AISI 316	AISI 316
14. Spindle Material	Martensitic SS 400 Series	Martensitic SS 400 Series	Martensitic SS 400 Series	Martensitic SS 400 Series
15. Spring Material	UNS N07750	UNS N07750	UNS N07750	UNS N07750
16. Bellow Material	UNS N06625	UNS N06625	UNS N06625	UNS N06625
17. Valve Testing	API 527	API 527	API 527	API 527
18. Notes	Not Applicable	Not Applicable	Not Applicable	Not Applicable

Valve Code	PSV-CB-1-C21M	PSV-CB-1-C21N	PSV-CB-1-C21P	PSV-CB-1-C21Q
Specs	C6 C9 C10 C19	C6 C9 C10 C19	C6 C9 C10 C19	C6 C9 C10 C19
1. Valve Type	Balanced	Balanced	Balanced	Balanced
2. Orifice Size	Orifice M (3.60 in ²)	Orifice N (4.34 in ²)	Orifice P (6.38 in ²)	Orifice Q (11.05 in ²)
3. Valve Specification Level (VSL)	VSL-1	VSL-1	VSL-1	VSL-1
4. Standard	API 520	API 520	API 520	API 520
5. Inlet/Outlet Size Range (NPS)	4" x 6"	4" x 6"	4" x 6"	6" x 8"
6. Inlet/Outlet end connection	ASME B16.5, RF x ASME B16.5, RF	ASME B16.5, RF x ASME B16.5, RF	ASME B16.5, RF x ASME B16.5, RF	ASME B16.5, RF x ASME B16.5, RF
7. Inlet/Outlet pressure class	300 x 150	300 x 150	300 x 150	300 x 150
8. Temperature	-46°C to 240°C	-46°C to 240°C	-46°C to 240°C	-46°C to 240°C
9. Material Class	Carbon Steel	Carbon Steel	Carbon Steel	Carbon Steel
10. Body and bonnet Material	ASTM A352 Gr LCB	ASTM A352 Gr LCB	ASTM A352 Gr LCB	ASTM A352 Gr LCB
11. Disc Material	AISI 316 + Stellite	AISI 316 + Stellite	AISI 316 + Stellite	AISI 316 + Stellite
12. Nozzle Material	AISI 316	AISI 316	AISI 316	AISI 316
13. Guide Material	AISI 316	AISI 316	AISI 316	AISI 316
14. Spindle Material	Martensitic SS 400 Series	Martensitic SS 400 Series	Martensitic SS 400 Series	Martensitic SS 400 Series
15. Spring Material	UNS N07750	UNS N07750	UNS N07750	UNS N07750
16. Bellow Material	UNS N06625	UNS N06625	UNS N06625	UNS N06625
17. Valve Testing	API 527	API 527	API 527	API 527
18. Notes	Not Applicable	Not Applicable	Not Applicable	Not Applicable

Valve Code	PSV-CB-1-C21R	PSV-CB-1-C21T	PSV-CB-1-D21D	PSV-CB-1-D21E
Specs	C6 C9 C10 C19	C6 C9 C10 C19	C16	C16
1. Valve Type	Balanced	Balanced	Balanced	Balanced
2. Orifice Size	Orifice R (16.00 in ²)	Orifice T (26.00 in ²)	Orifice D (A=0.110 in ²)	Orifice E (0.196 in ²)
3. Valve Specification Level (VSL)	VSL-1	VSL-1	VSL-1	VSL-1
4. Standard	API 520	API 520	API 520	API 520
5. Inlet/Outlet Size Range (NPS)	6" x 10"	8" x 10"	1" x 2"	1" x 2"
6. Inlet/Outlet end connection	ASME B16.5, RF x ASME B16.5, RF	ASME B16.5, RF x ASME B16.5, RF	ASME B16.5, RF x ASME B16.5, RF	ASME B16.5, RF x ASME B16.5, RF
7. Inlet/Outlet pressure class	300 x 150	300 x 150	300 x 150	300 x 150
8. Temperature	-46°C to 240°C	-46°C to 240°C	-50°C to 100°C	-50°C to 100°C
9. Material Class	Carbon Steel	Carbon Steel	Duplex Steel	Duplex Steel
10. Body and bonnet Material	ASTM A352 Gr LCB	ASTM A352 Gr LCB	ASTM A995 Gr 4a	ASTM A995 Gr 4a
11. Disc Material	AISI 316 + Stellite	AISI 316 + Stellite	ASTM A479 (UNS S31803)	ASTM A479 (UNS S31803)
12. Nozzle Material	AISI 316	AISI 316	ASTM A479 (UNS S31803)	ASTM A479 (UNS S31803)
13. Guide Material	AISI 316	AISI 316	AISI 316	AISI 316
14. Spindle Material	Martensitic SS 400 Series	Martensitic SS 400 Series	Martensitic SS 400 Series	Martensitic SS 400 Series
15. Spring Material	UNS N07750	UNS N07750	UNS N07750	UNS N07750
16. Bellow Material	UNS N06625	UNS N06625	UNS N06625	UNS N06625
17. Valve Testing	API 527	API 527	API 527	API 527
18. Notes	Not Applicable	Not Applicable	Not Applicable	Not Applicable

Valve Code	PSV-CB-1-D21F	PSV-CB-1-D21G	PSV-CB-1-D21H	PSV-CB-1-D21J
Specs	C16	C16	C16	C16
1. Valve Type	Balanced	Balanced	Balanced	Balanced
2. Orifice Size	Orifice F (0.307 in ²)	Orifice G (0.503 in ²)	Orifice H (0.785 in ²)	Orifice J (1.287 in ²)
3. Valve Specification Level (VSL)	VSL-1	VSL-1	VSL-1	VSL-1
4. Standard	API 520	API 520	API 520	API 520
5. Inlet/Outlet Size Range (NPS)	1 ½" x 2"	1 ½" x 3"	2" x 3"	3" x 4"
6. Inlet/Outlet end connection	ASME B16.5, RF x ASME B16.5, RF	ASME B16.5, RF x ASME B16.5, RF	ASME B16.5, RF x ASME B16.5, RF	ASME B16.5, RF x ASME B16.5, RF
7. Inlet/Outlet pressure class	300 x 150	300 x 150	300 x 150	300 x 150
8. Temperature	-50°C to 100°C	-50°C to 100°C	-50°C to 100°C	-50°C to 100°C
9. Material Class	Duplex Steel	Duplex Steel	Duplex Steel	Duplex Steel
10. Body and bonnet Material	ASTM A995 Gr 4a	ASTM A995 Gr 4a	ASTM A995 Gr 4a	ASTM A995 Gr 4a
11. Disc Material	ASTM A479 (UNS S31803)	ASTM A479 (UNS S31803)	ASTM A479 (UNS S31803)	ASTM A479 (UNS S31803)
12. Nozzle Material	ASTM A479 (UNS S31803)	ASTM A479 (UNS S31803)	ASTM A479 (UNS S31803)	ASTM A479 (UNS S31803)
13. Guide Material	AISI 316	AISI 316	AISI 316	AISI 316
14. Spindle Material	Martensitic SS 400 Series	Martensitic SS 400 Series	Martensitic SS 400 Series	Martensitic SS 400 Series
15. Spring Material	UNS N07750	UNS N07750	UNS N07750	UNS N07750
16. Bellow Material	UNS N06625	UNS N06625	UNS N06625	UNS N06625
17. Valve Testing	API 527	API 527	API 527	API 527
18. Notes	Not Applicable	Not Applicable	Not Applicable	Not Applicable

Valve Code	PSV-CB-1-D21K	PSV-CB-1-D21L	PSV-CB-1-D21M	PSV-CB-1-D21N
Specs	C16	C16	C16	C16
1. Valve Type	Balanced	Balanced	Balanced	Balanced
2. Orifice Size	Orifice K (1.838 in ²)	Orifice L (2.853 in ²)	Orifice M (3.60 in ²)	Orifice N (4.34 in ²)
3. Valve Specification Level (VSL)	VSL-1	VSL-1	VSL-1	VSL-1
4. Standard	API 520	API 520	API 520	API 520
5. Inlet/Outlet Size Range (NPS)	3" x 4"	4" x 6"	4" x 6"	4" x 6"
6. Inlet/Outlet end connection	ASME B16.5, RF x ASME B16.5, RF	ASME B16.5, RF x ASME B16.5, RF	ASME B16.5, RF x ASME B16.5, RF	ASME B16.5, RF x ASME B16.5, RF
7. Inlet/Outlet pressure class	300 x 150	300 x 150	300 x 150	300 x 150
8. Temperature	-50°C to 100°C	-50°C to 100°C	-50°C to 100°C	-50°C to 100°C
9. Material Class	Duplex Steel	Duplex Steel	Duplex Steel	Duplex Steel
10. Body and bonnet Material	ASTM A995 Gr 4a	ASTM A995 Gr 4a	ASTM A995 Gr 4a	ASTM A995 Gr 4a
11. Disc Material	ASTM A479 (UNS S31803)	ASTM A479 (UNS S31803)	ASTM A479 (UNS S31803)	ASTM A479 (UNS S31803)
12. Nozzle Material	ASTM A479 (UNS S31803)	ASTM A479 (UNS S31803)	ASTM A479 (UNS S31803)	ASTM A479 (UNS S31803)
13. Guide Material	AISI 316	AISI 316	AISI 316	AISI 316
14. Spindle Material	Martensitic SS 400 Series	Martensitic SS 400 Series	Martensitic SS 400 Series	Martensitic SS 400 Series
15. Spring Material	UNS N07750	UNS N07750	UNS N07750	UNS N07750
16. Bellow Material	UNS N06625	UNS N06625	UNS N06625	UNS N06625
17. Valve Testing	API 527	API 527	API 527	API 527
18. Notes	Not Applicable	Not Applicable	Not Applicable	Not Applicable

Valve Code	PSV-CB-1-D21P	PSV-CB-1-D21Q	PSV-CB-1-D21R	PSV-CB-1-D21T
Specs	C16	C16	C16	C16
1. Valve Type	Balanced	Balanced	Balanced	Balanced
2. Orifice Size	Orifice P (6.38 in ²)	Orifice Q (11.05 in ²)	Orifice R (16.00 in ²)	Orifice T (26.00 in ²)
3. Valve Specification Level (VSL)	VSL-1	VSL-1	VSL-1	VSL-1
4. Standard	API 520	API 520	API 520	API 520
5. Inlet/Outlet Size Range (NPS)	4" x 6"	6" x 8"	6" x 10"	8" x 10"
6. Inlet/Outlet end connection	ASME B16.5, RF x ASME B16.5, RF	ASME B16.5, RF x ASME B16.5, RF	ASME B16.5, RF x ASME B16.5, RF	ASME B16.5, RF x ASME B16.5, RF
7. Inlet/Outlet pressure class	300 x 150	300 x 150	300 x 150	300 x 150
8. Temperature	-50°C to 100°C	-50°C to 100°C	-50°C to 100°C	-50°C to 100°C
9. Material Class	Duplex Steel	Duplex Steel	Duplex Steel	Duplex Steel
10. Body and bonnet Material	ASTM A995 Gr 4a	ASTM A995 Gr 4a	ASTM A995 Gr 4a	ASTM A995 Gr 4a
11. Disc Material	ASTM A479 (UNS S31803)	ASTM A479 (UNS S31803)	ASTM A479 (UNS S31803)	ASTM A479 (UNS S31803)
12. Nozzle Material	ASTM A479 (UNS S31803)	ASTM A479 (UNS S31803)	ASTM A479 (UNS S31803)	ASTM A479 (UNS S31803)
13. Guide Material	AISI 316	AISI 316	AISI 316	AISI 316
14. Spindle Material	Martensitic SS 400 Series	Martensitic SS 400 Series	Martensitic SS 400 Series	Martensitic SS 400 Series
15. Spring Material	UNS N07750	UNS N07750	UNS N07750	UNS N07750
16. Bellow Material	UNS N06625	UNS N06625	UNS N06625	UNS N06625
17. Valve Testing	API 527	API 527	API 527	API 527
18. Notes	Not Applicable	Not Applicable	Not Applicable	Not Applicable

Valve Code	PSV-CB-1-D31D	PSV-CB-1-D31E	PSV-CB-1-D31F	PSV-CB-1-D31G
Specs	C12	C12	C12	C12
1. Valve Type	Balanced	Balanced	Balanced	Balanced
2. Orifice Size	Orifice D (A=0.110 in ²)	Orifice E (0.196 in ²)	Orifice F (0.307 in ²)	Orifice G (0.503 in ²)
3. Valve Specification Level (VSL)	VSL-1	VSL-1	VSL-1	VSL-1
4. Standard	API 520	API 520	API 520	API 520
5. Inlet/Outlet Size Range (NPS)	1" x 2"	1" x 2"	1 ½" x 2"	1 ½" x 3"
6. Inlet/Outlet end connection	ASME B16.5, RF x ASME B16.5, RF	ASME B16.5, RF x ASME B16.5, RF	ASME B16.5, RF x ASME B16.5, RF	ASME B16.5, RF x ASME B16.5, RF
7. Inlet/Outlet pressure class	300 x 150	300 x 150	300 x 150	300 x 150
8. Temperature	-50°C to 110°C	-50°C to 110°C	-50°C to 110°C	-50°C to 110°C
9. Material Class	Duplex Steel	Duplex Steel	Duplex Steel	Duplex Steel
10. Body and bonnet Material	ASTM A995 Gr 6a	ASTM A995 Gr 6a	ASTM A995 Gr 6a	ASTM A995 Gr 6a
11. Disc Material	ASTM A479 (UNS S32760)	ASTM A479 (UNS S32760)	ASTM A479 (UNS S32760)	ASTM A479 (UNS S32760)
12. Nozzle Material	ASTM A479 (UNS S32760)	ASTM A479 (UNS S32760)	ASTM A479 (UNS S32760)	ASTM A479 (UNS S32760)
13. Guide Material	AISI 316	AISI 316	AISI 316	AISI 316
14. Spindle Material	Martensitic SS 400 Series	Martensitic SS 400 Series	Martensitic SS 400 Series	Martensitic SS 400 Series
15. Spring Material	UNS N07750	UNS N07750	UNS N07750	UNS N07750
16. Bellow Material	UNS N06625	UNS N06625	UNS N06625	UNS N06625
17. Valve Testing	API 527	API 527	API 527	API 527
18. Notes	Not Applicable	Not Applicable	Not Applicable	Not Applicable

Valve Code	PSV-CB-1-D31H	PSV-CB-1-D31J	PSV-CB-1-D31K	PSV-CB-1-D31L
Specs	C12	C12	C12	C12
1. Valve Type	Balanced	Balanced	Balanced	Balanced
2. Orifice Size	Orifice H (0.785 in ²)	Orifice J (1.287 in ²)	Orifice K (1.838 in ²)	Orifice L (2.853 in ²)
3. Valve Specification Level (VSL)	VSL-1	VSL-1	VSL-1	VSL-1
4. Standard	API 520	API 520	API 520	API 520
5. Inlet/Outlet Size Range (NPS)	2" x 3"	3" x 4"	3" x 4"	4" x 6"
6. Inlet/Outlet end connection	ASME B16.5, RF x ASME B16.5, RF	ASME B16.5, RF x ASME B16.5, RF	ASME B16.5, RF x ASME B16.5, RF	ASME B16.5, RF x ASME B16.5, RF
7. Inlet/Outlet pressure class	300 x 150	300 x 150	300 x 150	300 x 150
8. Temperature	-50°C to 110°C	-50°C to 110°C	-50°C to 110°C	-50°C to 110°C
9. Material Class	Duplex Steel	Duplex Steel	Duplex Steel	Duplex Steel
10. Body and bonnet Material	ASTM A995 Gr 6a	ASTM A995 Gr 6a	ASTM A995 Gr 6a	ASTM A995 Gr 6a
11. Disc Material	ASTM A479 (UNS S32760)	ASTM A479 (UNS S32760)	ASTM A479 (UNS S32760)	ASTM A479 (UNS S32760)
12. Nozzle Material	ASTM A479 (UNS S32760)	ASTM A479 (UNS S32760)	ASTM A479 (UNS S32760)	ASTM A479 (UNS S32760)
13. Guide Material	AISI 316	AISI 316	AISI 316	AISI 316
14. Spindle Material	Martensitic SS 400 Series	Martensitic SS 400 Series	Martensitic SS 400 Series	Martensitic SS 400 Series
15. Spring Material	UNS N07750	UNS N07750	UNS N07750	UNS N07750
16. Bellow Material	UNS N06625	UNS N06625	UNS N06625	UNS N06625
17. Valve Testing	API 527	API 527	API 527	API 527
18. Notes	Not Applicable	Not Applicable	Not Applicable	Not Applicable

Valve Code	PSV-CB-1-D31M	PSV-CB-1-D31N	PSV-CB-1-D31P	PSV-CB-1-D31Q
Specs	C12	C12	C12	C12
1. Valve Type	Balanced	Balanced	Balanced	Balanced
2. Orifice Size	Orifice M (3.60 in ²)	Orifice N (4.34 in ²)	Orifice P (6.38 in ²)	Orifice Q (11.05 in ²)
3. Valve Specification Level (VSL)	VSL-1	VSL-1	VSL-1	VSL-1
4. Standard	API 520	API 520	API 520	API 520
5. Inlet/Outlet Size Range (NPS)	4" x 6"	4" x 6"	4" x 6"	6" x 8"
6. Inlet/Outlet end connection	ASME B16.5, RF x ASME B16.5, RF	ASME B16.5, RF x ASME B16.5, RF	ASME B16.5, RF x ASME B16.5, RF	ASME B16.5, RF x ASME B16.5, RF
7. Inlet/Outlet pressure class	300 x 150	300 x 150	300 x 150	300 x 150
8. Temperature	-50°C to 110°C	-50°C to 110°C	-50°C to 110°C	-50°C to 110°C
9. Material Class	Duplex Steel	Duplex Steel	Duplex Steel	Duplex Steel
10. Body and bonnet Material	ASTM A995 Gr 6a	ASTM A995 Gr 6a	ASTM A995 Gr 6a	ASTM A995 Gr 6a
11. Disc Material	ASTM A479 (UNS S32760)	ASTM A479 (UNS S32760)	ASTM A479 (UNS S32760)	ASTM A479 (UNS S32760)
12. Nozzle Material	ASTM A479 (UNS S32760)	ASTM A479 (UNS S32760)	ASTM A479 (UNS S32760)	ASTM A479 (UNS S32760)
13. Guide Material	AISI 316	AISI 316	AISI 316	AISI 316
14. Spindle Material	Martensitic SS 400 Series	Martensitic SS 400 Series	Martensitic SS 400 Series	Martensitic SS 400 Series
15. Spring Material	UNS N07750	UNS N07750	UNS N07750	UNS N07750
16. Bellow Material	UNS N06625	UNS N06625	UNS N06625	UNS N06625
17. Valve Testing	API 527	API 527	API 527	API 527
18. Notes	Not Applicable	Not Applicable	Not Applicable	Not Applicable

Valve Code	PSV-CB-1-D31R	PSV-CB-1-D31T	PSV-CB-1-N11D	PSV-CB-1-N11E
Specs	C12	C12	C30	C30
1. Valve Type	Balanced	Balanced	Balanced	Balanced
2. Orifice Size	Orifice R (16.00 in ²)	Orifice T (26.00 in ²)	Orifice D (A=0.110 in ²)	Orifice E (0.196 in ²)
3. Valve Specification Level (VSL)	VSL-1	VSL-1	VSL-1	VSL-1
4. Standard	API 520	API 520	API 520	API 520
5. Inlet/Outlet Size Range (NPS)	6" x 10"	8" x 10"	1" x 2"	1" x 2"
6. Inlet/Outlet end connection	ASME B16.5, RF x ASME B16.5, RF	ASME B16.5, RF x ASME B16.5, RF	ASME B16.5, RF x ASME B16.5, RF	ASME B16.5, RF x ASME B16.5, RF
7. Inlet/Outlet pressure class	300 x 150	300 x 150	300 x 150	300 x 150
8. Temperature	-50°C to 110°C	-50°C to 110°C	-100°C to 155°C	-100°C to 155°C
9. Material Class	Duplex Steel	Duplex Steel	Nickel Alloys	Nickel Alloys
10. Body and bonnet Material	ASTM A995 Gr 6a	ASTM A995 Gr 6a	UNS N06625	UNS N06625
11. Disc Material	ASTM A479 (UNS S32760)	ASTM A479 (UNS S32760)	UNS N06625	UNS N06625
12. Nozzle Material	ASTM A479 (UNS S32760)	ASTM A479 (UNS S32760)	ASTM B564 (UNS N06625)	ASTM B564 (UNS N06625)
13. Guide Material	AISI 316	AISI 316	AISI 316	AISI 316
14. Spindle Material	Martensitic SS 400 Series	Martensitic SS 400 Series	Martensitic SS 400 Series	Martensitic SS 400 Series
15. Spring Material	UNS N07750	UNS N07750	UNS N07750	UNS N07750
16. Bellow Material	UNS N06625	UNS N06625	UNS N06625	UNS N06625
17. Valve Testing	API 527	API 527	API 527	API 527
18. Notes	Not Applicable	Not Applicable	Not Applicable	Not Applicable

Valve Code	PSV-CB-1-N11F	PSV-CB-1-N11G	PSV-CB-1-N11H	PSV-CB-1-N11J
Specs	C30	C30	C30	C30
1. Valve Type	Balanced	Balanced	Balanced	Balanced
2. Orifice Size	Orifice F (0.307 in ²)	Orifice G (0.503 in ²)	Orifice H (0.785 in ²)	Orifice J (1.287 in ²)
3. Valve Specification Level (VSL)	VSL-1	VSL-1	VSL-1	VSL-1
4. Standard	API 520	API 520	API 520	API 520
5. Inlet/Outlet Size Range (NPS)	1 ½" x 2"	1 ½" x 3"	2" x 3"	3" x 4"
6. Inlet/Outlet end connection	ASME B16.5, RF x ASME B16.5, RF	ASME B16.5, RF x ASME B16.5, RF	ASME B16.5, RF x ASME B16.5, RF	ASME B16.5, RF x ASME B16.5, RF
7. Inlet/Outlet pressure class	300 x 150	300 x 150	300 x 150	300 x 150
8. Temperature	-100°C to 155°C	-100°C to 155°C	-100°C to 155°C	-100°C to 155°C
9. Material Class	Nickel Alloys	Nickel Alloys	Nickel Alloys	Nickel Alloys
10. Body and bonnet Material	UNS N06625	UNS N06625	UNS N06625	UNS N06625
11. Disc Material	UNS N06625	UNS N06625	UNS N06625	UNS N06625
12. Nozzle Material	ASTM B564 (UNS N06625)	ASTM B564 (UNS N06625)	ASTM B564 (UNS N06625)	ASTM B564 (UNS N06625)
13. Guide Material	AISI 316	AISI 316	AISI 316	AISI 316
14. Spindle Material	Martensitic SS 400 Series	Martensitic SS 400 Series	Martensitic SS 400 Series	Martensitic SS 400 Series
15. Spring Material	UNS N07750	UNS N07750	UNS N07750	UNS N07750
16. Bellow Material	UNS N06625	UNS N06625	UNS N06625	UNS N06625
17. Valve Testing	API 527	API 527	API 527	API 527
18. Notes	Not Applicable	Not Applicable	Not Applicable	Not Applicable

Valve Code	PSV-CB-1-N11K	PSV-CB-1-N11L	PSV-CB-1-N11M	PSV-CB-1-N11N
Specs	C30	C30	C30	C30
1. Valve Type	Balanced	Balanced	Balanced	Balanced
2. Orifice Size	Orifice K (1.838 in ²)	Orifice L (2.853 in ²)	Orifice M (3.60 in ²)	Orifice N (4.34 in ²)
3. Valve Specification Level (VSL)	VSL-1	VSL-1	VSL-1	VSL-1
4. Standard	API 520	API 520	API 520	API 520
5. Inlet/Outlet Size Range (NPS)	3" x 4"	4" x 6"	4" x 6"	4" x 6"
6. Inlet/Outlet end connection	ASME B16.5, RF x ASME B16.5, RF	ASME B16.5, RF x ASME B16.5, RF	ASME B16.5, RF x ASME B16.5, RF	ASME B16.5, RF x ASME B16.5, RF
7. Inlet/Outlet pressure class	300 x 150	300 x 150	300 x 150	300 x 150
8. Temperature	-100°C to 155°C	-100°C to 155°C	-100°C to 155°C	-100°C to 155°C
9. Material Class	Nickel Alloys	Nickel Alloys	Nickel Alloys	Nickel Alloys
10. Body and bonnet Material	UNS N06625	UNS N06625	UNS N06625	UNS N06625
11. Disc Material	UNS N06625	UNS N06625	UNS N06625	UNS N06625
12. Nozzle Material	ASTM B564 (UNS N06625)	ASTM B564 (UNS N06625)	ASTM B564 (UNS N06625)	ASTM B564 (UNS N06625)
13. Guide Material	AISI 316	AISI 316	AISI 316	AISI 316
14. Spindle Material	Martensitic SS 400 Series	Martensitic SS 400 Series	Martensitic SS 400 Series	Martensitic SS 400 Series
15. Spring Material	UNS N07750	UNS N07750	UNS N07750	UNS N07750
16. Bellow Material	UNS N06625	UNS N06625	UNS N06625	UNS N06625
17. Valve Testing	API 527	API 527	API 527	API 527
18. Notes	Not Applicable	Not Applicable	Not Applicable	Not Applicable

Valve Code	PSV-CB-1-N11P	PSV-CB-1-N11Q	PSV-CB-1-N11R	PSV-CB-1-N11T
Specs	C30	C30	C30	C30
1. Valve Type	Balanced	Balanced	Balanced	Balanced
2. Orifice Size	Orifice P (6.38 in ²)	Orifice Q (11.05 in ²)	Orifice R (16.00 in ²)	Orifice T (26.00 in ²)
3. Valve Specification Level (VSL)	VSL-1	VSL-1	VSL-1	VSL-1
4. Standard	API 520	API 520	API 520	API 520
5. Inlet/Outlet Size Range (NPS)	4" x 6"	6" x 8"	6" x 10"	8" x 10"
6. Inlet/Outlet end connection	ASME B16.5, RF x ASME B16.5, RF	ASME B16.5, RF x ASME B16.5, RF	ASME B16.5, RF x ASME B16.5, RF	ASME B16.5, RF x ASME B16.5, RF
7. Inlet/Outlet pressure class	300 x 150	300 x 150	300 x 150	300 x 150
8. Temperature	-100°C to 155°C	-100°C to 155°C	-100°C to 155°C	-100°C to 155°C
9. Material Class	Nickel Alloys	Nickel Alloys	Nickel Alloys	Nickel Alloys
10. Body and bonnet Material	UNS N06625	UNS N06625	UNS N06625	UNS N06625
11. Disc Material	UNS N06625	UNS N06625	UNS N06625	UNS N06625
12. Nozzle Material	ASTM B564 (UNS N06625)	ASTM B564 (UNS N06625)	ASTM B564 (UNS N06625)	ASTM B564 (UNS N06625)
13. Guide Material	AISI 316	AISI 316	AISI 316	AISI 316
14. Spindle Material	Martensitic SS 400 Series	Martensitic SS 400 Series	Martensitic SS 400 Series	Martensitic SS 400 Series
15. Spring Material	UNS N07750	UNS N07750	UNS N07750	UNS N07750
16. Bellow Material	UNS N06625	UNS N06625	UNS N06625	UNS N06625
17. Valve Testing	API 527	API 527	API 527	API 527
18. Notes	Not Applicable	Not Applicable	Not Applicable	Not Applicable

Valve Code	PSV-CB-1-S21D	PSV-CB-1-S21E	PSV-CB-1-S21F	PSV-CB-1-S21G
Specs	C3 C9 C10	C3 C9 C10	C3 C9 C10	C3 C9 C10
1. Valve Type	Balanced	Balanced	Balanced	Balanced
2. Orifice Size	Orifice D (A=0.110 in ²)	Orifice E (0.196 in ²)	Orifice F (0.307 in ²)	Orifice G (0.503 in ²)
3. Valve Specification Level (VSL)	VSL-1	VSL-1	VSL-1	VSL-1
4. Standard	API 520	API 520	API 520	API 520
5. Inlet/Outlet Size Range (NPS)	1" x 2"	1" x 2"	1 ½" x 2"	1 ½" x 3"
6. Inlet/Outlet end connection	ASME B16.5, RF x ASME B16.5, RF	ASME B16.5, RF x ASME B16.5, RF	ASME B16.5, RF x ASME B16.5, RF	ASME B16.5, RF x ASME B16.5, RF
7. Inlet/Outlet pressure class	300 x 150	300 x 150	300 x 150	300 x 150
8. Temperature	-100°C to 260°C	-100°C to 260°C	-100°C to 260°C	-100°C to 260°C
9. Material Class	Stainless Steel	Stainless Steel	Stainless Steel	Stainless Steel
10. Body and bonnet Material	ASTM A182 Gr CF8M	ASTM A182 Gr CF8M	ASTM A182 Gr CF8M	ASTM A182 Gr CF8M
11. Disc Material	AISI 316 + Stellite	AISI 316 + Stellite	AISI 316 + Stellite	AISI 316 + Stellite
12. Nozzle Material	AISI 316	AISI 316	AISI 316	AISI 316
13. Guide Material	AISI 316	AISI 316	AISI 316	AISI 316
14. Spindle Material	Martensitic SS 400 Series	Martensitic SS 400 Series	Martensitic SS 400 Series	Martensitic SS 400 Series
15. Spring Material	UNS N07750	UNS N07750	UNS N07750	UNS N07750
16. Bellow Material	UNS N06625	UNS N06625	UNS N06625	UNS N06625
17. Valve Testing	API 527	API 527	API 527	API 527
18. Notes	Not Applicable	Not Applicable	Not Applicable	Not Applicable

Valve Code	PSV-CB-1-S21H	PSV-CB-1-S21J	PSV-CB-1-S21K	PSV-CB-1-S21L
Specs	C3 C9 C10	C3 C9 C10	C3 C9 C10	C3 C9 C10
1. Valve Type	Balanced	Balanced	Balanced	Balanced
2. Orifice Size	Orifice H (0.785 in ²)	Orifice J (1.287 in ²)	Orifice K (1.838 in ²)	Orifice L (2.853 in ²)
3. Valve Specification Level (VSL)	VSL-1	VSL-1	VSL-1	VSL-1
4. Standard	API 520	API 520	API 520	API 520
5. Inlet/Outlet Size Range (NPS)	2" x 3"	3" x 4"	3" x 4"	4" x 6"
6. Inlet/Outlet end connection	ASME B16.5, RF x ASME B16.5, RF	ASME B16.5, RF x ASME B16.5, RF	ASME B16.5, RF x ASME B16.5, RF	ASME B16.5, RF x ASME B16.5, RF
7. Inlet/Outlet pressure class	300 x 150	300 x 150	300 x 150	300 x 150
8. Temperature	-100°C to 260°C	-100°C to 260°C	-100°C to 260°C	-100°C to 260°C
9. Material Class	Stainless Steel	Stainless Steel	Stainless Steel	Stainless Steel
10. Body and bonnet Material	ASTM A182 Gr CF8M	ASTM A182 Gr CF8M	ASTM A182 Gr CF8M	ASTM A182 Gr CF8M
11. Disc Material	AISI 316 + Stellite	AISI 316 + Stellite	AISI 316 + Stellite	AISI 316 + Stellite
12. Nozzle Material	AISI 316	AISI 316	AISI 316	AISI 316
13. Guide Material	AISI 316	AISI 316	AISI 316	AISI 316
14. Spindle Material	Martensitic SS 400 Series	Martensitic SS 400 Series	Martensitic SS 400 Series	Martensitic SS 400 Series
15. Spring Material	UNS N07750	UNS N07750	UNS N07750	UNS N07750
16. Bellow Material	UNS N06625	UNS N06625	UNS N06625	UNS N06625
17. Valve Testing	API 527	API 527	API 527	API 527
18. Notes	Not Applicable	Not Applicable	Not Applicable	Not Applicable

Valve Code	PSV-CB-1-S21M	PSV-CB-1-S21N	PSV-CB-1-S21P	PSV-CB-1-S21Q
Specs	C3 C9 C10	C3 C9 C10	C3 C9 C10	C3 C9 C10
1. Valve Type	Balanced	Balanced	Balanced	Balanced
2. Orifice Size	Orifice M (3.60 in ²)	Orifice N (4.34 in ²)	Orifice P (6.38 in ²)	Orifice Q (11.05 in ²)
3. Valve Specification Level (VSL)	VSL-1	VSL-1	VSL-1	VSL-1
4. Standard	API 520	API 520	API 520	API 520
5. Inlet/Outlet Size Range (NPS)	4" x 6"	4" x 6"	4" x 6"	6" x 8"
6. Inlet/Outlet end connection	ASME B16.5, RF x ASME B16.5, RF	ASME B16.5, RF x ASME B16.5, RF	ASME B16.5, RF x ASME B16.5, RF	ASME B16.5, RF x ASME B16.5, RF
7. Inlet/Outlet pressure class	300 x 150	300 x 150	300 x 150	300 x 150
8. Temperature	-100°C to 260°C	-100°C to 260°C	-100°C to 260°C	-100°C to 260°C
9. Material Class	Stainless Steel	Stainless Steel	Stainless Steel	Stainless Steel
10. Body and bonnet Material	ASTM A182 Gr CF8M	ASTM A182 Gr CF8M	ASTM A182 Gr CF8M	ASTM A182 Gr CF8M
11. Disc Material	AISI 316 + Stellite	AISI 316 + Stellite	AISI 316 + Stellite	AISI 316 + Stellite
12. Nozzle Material	AISI 316	AISI 316	AISI 316	AISI 316
13. Guide Material	AISI 316	AISI 316	AISI 316	AISI 316
14. Spindle Material	Martensitic SS 400 Series	Martensitic SS 400 Series	Martensitic SS 400 Series	Martensitic SS 400 Series
15. Spring Material	UNS N07750	UNS N07750	UNS N07750	UNS N07750
16. Bellow Material	UNS N06625	UNS N06625	UNS N06625	UNS N06625
17. Valve Testing	API 527	API 527	API 527	API 527
18. Notes	Not Applicable	Not Applicable	Not Applicable	Not Applicable

Valve Code	PSV-CB-1-S21R	PSV-CB-1-S21T	PSV-CB-2-C10D	PSV-CB-2-C10E
Specs	C3 C9 C10	C3 C9 C10	C4 C9 C10	C4 C9 C10
1. Valve Type	Balanced	Balanced	Conventional	Conventional
2. Orifice Size	Orifice R (16.00 in ²)	Orifice T (26.00 in ²)	Orifice D (A=0.110 in ²)	Orifice E (0.196 in ²)
3. Valve Specification Level (VSL)	VSL-1	VSL-1	VSL-2	VSL-2
4. Standard	API 520	API 520	API 520	API 520
5. Inlet/Outlet Size Range (NPS)	6" x 10"	8" x 10"	1" x 2"	1" x 2"
6. Inlet/Outlet end connection	ASME B16.5, RF x ASME B16.5, RF	ASME B16.5, RF x ASME B16.5, RF	ASME B16.5, RF x ASME B16.5, RF	ASME B16.5, RF x ASME B16.5, RF
7. Inlet/Outlet pressure class	300 x 150	300 x 150	300 x 150	300 x 150
8. Temperature	-100°C to 260°C	-100°C to 260°C	0°C to 240°C	0°C to 240°C
9. Material Class	Stainless Steel	Stainless Steel	Carbon Steel	Carbon Steel
10. Body and bonnet Material	ASTM A182 Gr CF8M	ASTM A182 Gr CF8M	ASTM A216 Gr WCB	ASTM A216 Gr WCB
11. Disc Material	AISI 316 + Stellite	AISI 316 + Stellite	Martensitic SS 400 Series	Martensitic SS 400 Series
12. Nozzle Material	AISI 316	AISI 316	AISI 316	AISI 316
13. Guide Material	AISI 316	AISI 316	AISI 316	AISI 316
14. Spindle Material	Martensitic SS 400 Series	Martensitic SS 400 Series	Martensitic SS 400 Series	Martensitic SS 400 Series
15. Spring Material	UNS N07750	UNS N07750	UNS N07750	UNS N07750
16. Bellow Material	UNS N06625	UNS N06625	Not applicable	Not applicable
17. Valve Testing	API 527	API 527	API 527	API 527
18. Notes	Not Applicable	Not Applicable	Not Applicable	Not Applicable

Valve Code	PSV-CB-2-C10F	PSV-CB-2-C10G	PSV-CB-2-C10H	PSV-CB-2-C10J
Specs	C4 C9 C10	C4 C9 C10	C4 C9 C10	C4 C9 C10
1. Valve Type	Conventional	Conventional	Conventional	Conventional
2. Orifice Size	Orifice F (0.307 in ²)	Orifice G (0.503 in ²)	Orifice H (0.785 in ²)	Orifice J (1.287 in ²)
3. Valve Specification Level (VSL)	VSL-2	VSL-2	VSL-2	VSL-2
4. Standard	API 520	API 520	API 520	API 520
5. Inlet/Outlet Size Range (NPS)	1 ½" x 2"	1 ½" x 3"	2" x 3"	3" x 4"
6. Inlet/Outlet end connection	ASME B16.5, RF x ASME B16.5, RF	ASME B16.5, RF x ASME B16.5, RF	ASME B16.5, RF x ASME B16.5, RF	ASME B16.5, RF x ASME B16.5, RF
7. Inlet/Outlet pressure class	300 x 150	300 x 150	300 x 150	300 x 150
8. Temperature	0°C to 240°C	0°C to 240°C	0°C to 240°C	0°C to 240°C
9. Material Class	Carbon Steel	Carbon Steel	Carbon Steel	Carbon Steel
10. Body and bonnet Material	ASTM A216 Gr WCB	ASTM A216 Gr WCB	ASTM A216 Gr WCB	ASTM A216 Gr WCB
11. Disc Material	Martensitic SS 400 Series	Martensitic SS 400 Series	Martensitic SS 400 Series	Martensitic SS 400 Series
12. Nozzle Material	AISI 316	AISI 316	AISI 316	AISI 316
13. Guide Material	AISI 316	AISI 316	AISI 316	AISI 316
14. Spindle Material	Martensitic SS 400 Series	Martensitic SS 400 Series	Martensitic SS 400 Series	Martensitic SS 400 Series
15. Spring Material	UNS N07750	UNS N07750	UNS N07750	UNS N07750
16. Bellow Material	Not applicable	Not applicable	Not applicable	Not applicable
17. Valve Testing	API 527	API 527	API 527	API 527
18. Notes	Not Applicable	Not Applicable	Not Applicable	Not Applicable

Valve Code	PSV-CB-2-C10K	PSV-CB-2-C10L	PSV-CB-2-C10M	PSV-CB-2-C10N
Specs	C4 C9 C10	C4 C9 C10	C4 C9 C10	C4 C9 C10
1. Valve Type	Conventional	Conventional	Conventional	Conventional
2. Orifice Size	Orifice K (1.838 in ²)	Orifice L (2.853 in ²)	Orifice M (3.60 in ²)	Orifice N (4.34 in ²)
3. Valve Specification Level (VSL)	VSL-2	VSL-2	VSL-2	VSL-2
4. Standard	API 520	API 520	API 520	API 520
5. Inlet/Outlet Size Range (NPS)	3" x 4"	4" x 6"	4" x 6"	4" x 6"
6. Inlet/Outlet end connection	ASME B16.5, RF x ASME B16.5, RF	ASME B16.5, RF x ASME B16.5, RF	ASME B16.5, RF x ASME B16.5, RF	ASME B16.5, RF x ASME B16.5, RF
7. Inlet/Outlet pressure class	300 x 150	300 x 150	300 x 150	300 x 150
8. Temperature	0°C to 240°C	0°C to 240°C	0°C to 240°C	0°C to 240°C
9. Material Class	Carbon Steel	Carbon Steel	Carbon Steel	Carbon Steel
10. Body and bonnet Material	ASTM A216 Gr WCB	ASTM A216 Gr WCB	ASTM A216 Gr WCB	ASTM A216 Gr WCB
11. Disc Material	Martensitic SS 400 Series	Martensitic SS 400 Series	Martensitic SS 400 Series	Martensitic SS 400 Series
12. Nozzle Material	AISI 316	AISI 316	AISI 316	AISI 316
13. Guide Material	AISI 316	AISI 316	AISI 316	AISI 316
14. Spindle Material	Martensitic SS 400 Series	Martensitic SS 400 Series	Martensitic SS 400 Series	Martensitic SS 400 Series
15. Spring Material	UNS N07750	UNS N07750	UNS N07750	UNS N07750
16. Bellow Material	Not applicable	Not applicable	Not applicable	Not applicable
17. Valve Testing	API 527	API 527	API 527	API 527
18. Notes	Not Applicable	Not Applicable	Not Applicable	Not Applicable

Valve Code	PSV-CB-2-C10P	PSV-CB-2-C10Q	PSV-CB-2-C10R	PSV-CB-2-C10T
Specs	C4 C9 C10	C4 C9 C10	C4 C9 C10	C4 C9 C10
1. Valve Type	Conventional	Conventional	Conventional	Conventional
2. Orifice Size	Orifice P (6.38 in ²)	Orifice Q (11.05 in ²)	Orifice R (16.00 in ²)	Orifice T (26.00 in ²)
3. Valve Specification Level (VSL)	VSL-2	VSL-2	VSL-2	VSL-2
4. Standard	API 520	API 520	API 520	API 520
5. Inlet/Outlet Size Range (NPS)	4" x 6"	6" x 8"	6" x 10"	8" x 10"
6. Inlet/Outlet end connection	ASME B16.5, RF x ASME B16.5, RF	ASME B16.5, RF x ASME B16.5, RF	ASME B16.5, RF x ASME B16.5, RF	ASME B16.5, RF x ASME B16.5, RF
7. Inlet/Outlet pressure class	300 x 150	300 x 150	300 x 150	300 x 150
8. Temperature	0°C to 240°C	0°C to 240°C	0°C to 240°C	0°C to 240°C
9. Material Class	Carbon Steel	Carbon Steel	Carbon Steel	Carbon Steel
10. Body and bonnet Material	ASTM A216 Gr WCB	ASTM A216 Gr WCB	ASTM A216 Gr WCB	ASTM A216 Gr WCB
11. Disc Material	Martensitic SS 400 Series	Martensitic SS 400 Series	Martensitic SS 400 Series	Martensitic SS 400 Series
12. Nozzle Material	AISI 316	AISI 316	AISI 316	AISI 316
13. Guide Material	AISI 316	AISI 316	AISI 316	AISI 316
14. Spindle Material	Martensitic SS 400 Series	Martensitic SS 400 Series	Martensitic SS 400 Series	Martensitic SS 400 Series
15. Spring Material	UNS N07750	UNS N07750	UNS N07750	UNS N07750
16. Bellow Material	Not applicable	Not applicable	Not applicable	Not applicable
17. Valve Testing	API 527	API 527	API 527	API 527
18. Notes	Not Applicable	Not Applicable	Not Applicable	Not Applicable

Valve Code	PSV-CB-2-C11D	PSV-CB-2-C11E	PSV-CB-2-C11F	PSV-CB-2-C11G
Specs	C4 C9 C10	C4 C9 C10	C4 C9 C10	C4 C9 C10
1. Valve Type	Balanced	Balanced	Balanced	Balanced
2. Orifice Size	Orifice D (A=0.110 in ²)	Orifice E (0.196 in ²)	Orifice F (0.307 in ²)	Orifice G (0.503 in ²)
3. Valve Specification Level (VSL)	VSL-2	VSL-2	VSL-2	VSL-2
4. Standard	API 520	API 520	API 520	API 520
5. Inlet/Outlet Size Range (NPS)	1" x 2"	1" x 2"	1 ½" x 2"	1 ½" x 3"
6. Inlet/Outlet end connection	ASME B16.5, RF x ASME B16.5, RF	ASME B16.5, RF x ASME B16.5, RF	ASME B16.5, RF x ASME B16.5, RF	ASME B16.5, RF x ASME B16.5, RF
7. Inlet/Outlet pressure class	300 x 150	300 x 150	300 x 150	300 x 150
8. Temperature	0°C to 240°C	0°C to 240°C	0°C to 240°C	0°C to 240°C
9. Material Class	Carbon Steel	Carbon Steel	Carbon Steel	Carbon Steel
10. Body and bonnet Material	ASTM A216 Gr WCB	ASTM A216 Gr WCB	ASTM A216 Gr WCB	ASTM A216 Gr WCB
11. Disc Material	Martensitic SS 400 Series	Martensitic SS 400 Series	Martensitic SS 400 Series	Martensitic SS 400 Series
12. Nozzle Material	AISI 316	AISI 316	AISI 316	AISI 316
13. Guide Material	AISI 316	AISI 316	AISI 316	AISI 316
14. Spindle Material	Martensitic SS 400 Series	Martensitic SS 400 Series	Martensitic SS 400 Series	Martensitic SS 400 Series
15. Spring Material	UNS N07750	UNS N07750	UNS N07750	UNS N07750
16. Bellow Material	UNS N06625	UNS N06625	UNS N06625	UNS N06625
17. Valve Testing	API 527	API 527	API 527	API 527
18. Notes	Not Applicable	Not Applicable	Not Applicable	Not Applicable

Valve Code	PSV-CB-2-C11H	PSV-CB-2-C11J	PSV-CB-2-C11K	PSV-CB-2-C11L
Specs	C4 C9 C10	C4 C9 C10	C4 C9 C10	C4 C9 C10
1. Valve Type	Balanced	Balanced	Balanced	Balanced
2. Orifice Size	Orifice H (0.785 in ²)	Orifice J (1.287 in ²)	Orifice K (1.838 in ²)	Orifice L (2.853 in ²)
3. Valve Specification Level (VSL)	VSL-2	VSL-2	VSL-2	VSL-2
4. Standard	API 520	API 520	API 520	API 520
5. Inlet/Outlet Size Range (NPS)	2" x 3"	3" x 4"	3" x 4"	4" x 6"
6. Inlet/Outlet end connection	ASME B16.5, RF x ASME B16.5, RF	ASME B16.5, RF x ASME B16.5, RF	ASME B16.5, RF x ASME B16.5, RF	ASME B16.5, RF x ASME B16.5, RF
7. Inlet/Outlet pressure class	300 x 150	300 x 150	300 x 150	300 x 150
8. Temperature	0°C to 240°C	0°C to 240°C	0°C to 240°C	0°C to 240°C
9. Material Class	Carbon Steel	Carbon Steel	Carbon Steel	Carbon Steel
10. Body and bonnet Material	ASTM A216 Gr WCB	ASTM A216 Gr WCB	ASTM A216 Gr WCB	ASTM A216 Gr WCB
11. Disc Material	Martensitic SS 400 Series	Martensitic SS 400 Series	Martensitic SS 400 Series	Martensitic SS 400 Series
12. Nozzle Material	AISI 316	AISI 316	AISI 316	AISI 316
13. Guide Material	AISI 316	AISI 316	AISI 316	AISI 316
14. Spindle Material	Martensitic SS 400 Series	Martensitic SS 400 Series	Martensitic SS 400 Series	Martensitic SS 400 Series
15. Spring Material	UNS N07750	UNS N07750	UNS N07750	UNS N07750
16. Bellow Material	UNS N06625	UNS N06625	UNS N06625	UNS N06625
17. Valve Testing	API 527	API 527	API 527	API 527
18. Notes	Not Applicable	Not Applicable	Not Applicable	Not Applicable

Valve Code	PSV-CB-2-C11M	PSV-CB-2-C11N	PSV-CB-2-C11P	PSV-CB-2-C11Q
Specs	C4 C9 C10	C4 C9 C10	C4 C9 C10	C4 C9 C10
1. Valve Type	Balanced	Balanced	Balanced	Balanced
2. Orifice Size	Orifice M (3.60 in ²)	Orifice N (4.34 in ²)	Orifice P (6.38 in ²)	Orifice Q (11.05 in ²)
3. Valve Specification Level (VSL)	VSL-2	VSL-2	VSL-2	VSL-2
4. Standard	API 520	API 520	API 520	API 520
5. Inlet/Outlet Size Range (NPS)	4" x 6"	4" x 6"	4" x 6"	6" x 8"
6. Inlet/Outlet end connection	ASME B16.5, RF x ASME B16.5, RF	ASME B16.5, RF x ASME B16.5, RF	ASME B16.5, RF x ASME B16.5, RF	ASME B16.5, RF x ASME B16.5, RF
7. Inlet/Outlet pressure class	300 x 150	300 x 150	300 x 150	300 x 150
8. Temperature	0°C to 240°C	0°C to 240°C	0°C to 240°C	0°C to 240°C
9. Material Class	Carbon Steel	Carbon Steel	Carbon Steel	Carbon Steel
10. Body and bonnet Material	ASTM A216 Gr WCB	ASTM A216 Gr WCB	ASTM A216 Gr WCB	ASTM A216 Gr WCB
11. Disc Material	Martensitic SS 400 Series	Martensitic SS 400 Series	Martensitic SS 400 Series	Martensitic SS 400 Series
12. Nozzle Material	AISI 316	AISI 316	AISI 316	AISI 316
13. Guide Material	AISI 316	AISI 316	AISI 316	AISI 316
14. Spindle Material	Martensitic SS 400 Series	Martensitic SS 400 Series	Martensitic SS 400 Series	Martensitic SS 400 Series
15. Spring Material	UNS N07750	UNS N07750	UNS N07750	UNS N07750
16. Bellow Material	UNS N06625	UNS N06625	UNS N06625	UNS N06625
17. Valve Testing	API 527	API 527	API 527	API 527
18. Notes	Not Applicable	Not Applicable	Not Applicable	Not Applicable

Valve Code	PSV-CB-2-C11R	PSV-CB-2-C11T	PSV-CB-2-C20D	PSV-CB-2-C20E
Specs	C4 C9 C10	C4 C9 C10	C6 C9 C10 C19	C6 C9 C10 C19
1. Valve Type	Balanced	Balanced	Conventional	Conventional
2. Orifice Size	Orifice R (16.00 in ²)	Orifice T (26.00 in ²)	Orifice D (A=0.110 in ²)	Orifice E (0.196 in ²)
3. Valve Specification Level (VSL)	VSL-2	VSL-2	VSL-2	VSL-2
4. Standard	API 520	API 520	API 520	API 520
5. Inlet/Outlet Size Range (NPS)	6" x 10"	8" x 10"	1" x 2"	1" x 2"
6. Inlet/Outlet end connection	ASME B16.5, RF x ASME B16.5, RF	ASME B16.5, RF x ASME B16.5, RF	ASME B16.5, RF x ASME B16.5, RF	ASME B16.5, RF x ASME B16.5, RF
7. Inlet/Outlet pressure class	300 x 150	300 x 150	300 x 150	300 x 150
8. Temperature	0°C to 240°C	0°C to 240°C	-46°C to 240°C	-46°C to 240°C
9. Material Class	Carbon Steel	Carbon Steel	Carbon Steel	Carbon Steel
10. Body and bonnet Material	ASTM A216 Gr WCB	ASTM A216 Gr WCB	ASTM A352 Gr LCB	ASTM A352 Gr LCB
11. Disc Material	Martensitic SS 400 Series	Martensitic SS 400 Series	AISI 316 + Stellite	AISI 316 + Stellite
12. Nozzle Material	AISI 316	AISI 316	AISI 316	AISI 316
13. Guide Material	AISI 316	AISI 316	AISI 316	AISI 316
14. Spindle Material	Martensitic SS 400 Series	Martensitic SS 400 Series	Martensitic SS 400 Series	Martensitic SS 400 Series
15. Spring Material	UNS N07750	UNS N07750	UNS N07750	UNS N07750
16. Bellow Material	UNS N06625	UNS N06625	Not applicable	Not applicable
17. Valve Testing	API 527	API 527	API 527	API 527
18. Notes	Not Applicable	Not Applicable	Not Applicable	Not Applicable

Valve Code	PSV-CB-2-C20F	PSV-CB-2-C20G	PSV-CB-2-C20H	PSV-CB-2-C20J
Specs	C6 C9 C10 C19	C6 C9 C10 C19	C6 C9 C10 C19	C6 C9 C10 C19
1. Valve Type	Conventional	Conventional	Conventional	Conventional
2. Orifice Size	Orifice F (0.307 in ²)	Orifice G (0.503 in ²)	Orifice H (0.785 in ²)	Orifice J (1.287 in ²)
3. Valve Specification Level (VSL)	VSL-2	VSL-2	VSL-2	VSL-2
4. Standard	API 520	API 520	API 520	API 520
5. Inlet/Outlet Size Range (NPS)	1 ½" x 2"	1 ½" x 3"	2" x 3"	3" x 4"
6. Inlet/Outlet end connection	ASME B16.5, RF x ASME B16.5, RF	ASME B16.5, RF x ASME B16.5, RF	ASME B16.5, RF x ASME B16.5, RF	ASME B16.5, RF x ASME B16.5, RF
7. Inlet/Outlet pressure class	300 x 150	300 x 150	300 x 150	300 x 150
8. Temperature	-46°C to 240°C	-46°C to 240°C	-46°C to 240°C	-46°C to 240°C
9. Material Class	Carbon Steel	Carbon Steel	Carbon Steel	Carbon Steel
10. Body and bonnet Material	ASTM A352 Gr LCB	ASTM A352 Gr LCB	ASTM A352 Gr LCB	ASTM A352 Gr LCB
11. Disc Material	AISI 316 + Stellite	AISI 316 + Stellite	AISI 316 + Stellite	AISI 316 + Stellite
12. Nozzle Material	AISI 316	AISI 316	AISI 316	AISI 316
13. Guide Material	AISI 316	AISI 316	AISI 316	AISI 316
14. Spindle Material	Martensitic SS 400 Series	Martensitic SS 400 Series	Martensitic SS 400 Series	Martensitic SS 400 Series
15. Spring Material	UNS N07750	UNS N07750	UNS N07750	UNS N07750
16. Bellow Material	Not applicable	Not applicable	Not applicable	Not applicable
17. Valve Testing	API 527	API 527	API 527	API 527
18. Notes	Not Applicable	Not Applicable	Not Applicable	Not Applicable

Valve Code	PSV-CB-2-C20K	PSV-CB-2-C20L	PSV-CB-2-C20M	PSV-CB-2-C20N
Specs	C6 C9 C10 C19	C6 C9 C10 C19	C6 C9 C10 C19	C6 C9 C10 C19
1. Valve Type	Conventional	Conventional	Conventional	Conventional
2. Orifice Size	Orifice K (1.838 in ²)	Orifice L (2.853 in ²)	Orifice M (3.60 in ²)	Orifice N (4.34 in ²)
3. Valve Specification Level (VSL)	VSL-2	VSL-2	VSL-2	VSL-2
4. Standard	API 520	API 520	API 520	API 520
5. Inlet/Outlet Size Range (NPS)	3" x 4"	4" x 6"	4" x 6"	4" x 6"
6. Inlet/Outlet end connection	ASME B16.5, RF x ASME B16.5, RF	ASME B16.5, RF x ASME B16.5, RF	ASME B16.5, RF x ASME B16.5, RF	ASME B16.5, RF x ASME B16.5, RF
7. Inlet/Outlet pressure class	300 x 150	300 x 150	300 x 150	300 x 150
8. Temperature	-46°C to 240°C	-46°C to 240°C	-46°C to 240°C	-46°C to 240°C
9. Material Class	Carbon Steel	Carbon Steel	Carbon Steel	Carbon Steel
10. Body and bonnet Material	ASTM A352 Gr LCB	ASTM A352 Gr LCB	ASTM A352 Gr LCB	ASTM A352 Gr LCB
11. Disc Material	AISI 316 + Stellite	AISI 316 + Stellite	AISI 316 + Stellite	AISI 316 + Stellite
12. Nozzle Material	AISI 316	AISI 316	AISI 316	AISI 316
13. Guide Material	AISI 316	AISI 316	AISI 316	AISI 316
14. Spindle Material	Martensitic SS 400 Series	Martensitic SS 400 Series	Martensitic SS 400 Series	Martensitic SS 400 Series
15. Spring Material	UNS N07750	UNS N07750	UNS N07750	UNS N07750
16. Bellow Material	Not applicable	Not applicable	Not applicable	Not applicable
17. Valve Testing	API 527	API 527	API 527	API 527
18. Notes	Not Applicable	Not Applicable	Not Applicable	Not Applicable

Valve Code	PSV-CB-2-C20P	PSV-CB-2-C20Q	PSV-CB-2-C20R	PSV-CB-2-C20T
Specs	C6 C9 C10 C19	C6 C9 C10 C19	C6 C9 C10 C19	C6 C9 C10 C19
1. Valve Type	Conventional	Conventional	Conventional	Conventional
2. Orifice Size	Orifice P (6.38 in ²)	Orifice Q (11.05 in ²)	Orifice R (16.00 in ²)	Orifice T (26.00 in ²)
3. Valve Specification Level (VSL)	VSL-2	VSL-2	VSL-2	VSL-2
4. Standard	API 520	API 520	API 520	API 520
5. Inlet/Outlet Size Range (NPS)	4" x 6"	6" x 8"	6" x 10"	8" x 10"
6. Inlet/Outlet end connection	ASME B16.5, RF x ASME B16.5, RF	ASME B16.5, RF x ASME B16.5, RF	ASME B16.5, RF x ASME B16.5, RF	ASME B16.5, RF x ASME B16.5, RF
7. Inlet/Outlet pressure class	300 x 150	300 x 150	300 x 150	300 x 150
8. Temperature	-46°C to 240°C	-46°C to 240°C	-46°C to 240°C	-46°C to 240°C
9. Material Class	Carbon Steel	Carbon Steel	Carbon Steel	Carbon Steel
10. Body and bonnet Material	ASTM A352 Gr LCB	ASTM A352 Gr LCB	ASTM A352 Gr LCB	ASTM A352 Gr LCB
11. Disc Material	AISI 316 + Stellite	AISI 316 + Stellite	AISI 316 + Stellite	AISI 316 + Stellite
12. Nozzle Material	AISI 316	AISI 316	AISI 316	AISI 316
13. Guide Material	AISI 316	AISI 316	AISI 316	AISI 316
14. Spindle Material	Martensitic SS 400 Series	Martensitic SS 400 Series	Martensitic SS 400 Series	Martensitic SS 400 Series
15. Spring Material	UNS N07750	UNS N07750	UNS N07750	UNS N07750
16. Bellow Material	Not applicable	Not applicable	Not applicable	Not applicable
17. Valve Testing	API 527	API 527	API 527	API 527
18. Notes	Not Applicable	Not Applicable	Not Applicable	Not Applicable

Valve Code	PSV-CB-2-C21D	PSV-CB-2-C21E	PSV-CB-2-C21F	PSV-CB-2-C21G
Specs	C6 C9 C10 C19	C6 C9 C10 C19	C6 C9 C10 C19	C6 C9 C10 C19
1. Valve Type	Balanced	Balanced	Balanced	Balanced
2. Orifice Size	Orifice D (A=0.110 in ²)	Orifice E (0.196 in ²)	Orifice F (0.307 in ²)	Orifice G (0.503 in ²)
3. Valve Specification Level (VSL)	VSL-2	VSL-2	VSL-2	VSL-2
4. Standard	API 520	API 520	API 520	API 520
5. Inlet/Outlet Size Range (NPS)	1" x 2"	1" x 2"	1 ½" x 2"	1 ½" x 3"
6. Inlet/Outlet end connection	ASME B16.5, RF x ASME B16.5, RF	ASME B16.5, RF x ASME B16.5, RF	ASME B16.5, RF x ASME B16.5, RF	ASME B16.5, RF x ASME B16.5, RF
7. Inlet/Outlet pressure class	300 x 150	300 x 150	300 x 150	300 x 150
8. Temperature	-46°C to 240°C	-46°C to 240°C	-46°C to 240°C	-46°C to 240°C
9. Material Class	Carbon Steel	Carbon Steel	Carbon Steel	Carbon Steel
10. Body and bonnet Material	ASTM A352 Gr LCB	ASTM A352 Gr LCB	ASTM A352 Gr LCB	ASTM A352 Gr LCB
11. Disc Material	AISI 316 + Stellite	AISI 316 + Stellite	AISI 316 + Stellite	AISI 316 + Stellite
12. Nozzle Material	AISI 316	AISI 316	AISI 316	AISI 316
13. Guide Material	AISI 316	AISI 316	AISI 316	AISI 316
14. Spindle Material	Martensitic SS 400 Series	Martensitic SS 400 Series	Martensitic SS 400 Series	Martensitic SS 400 Series
15. Spring Material	UNS N07750	UNS N07750	UNS N07750	UNS N07750
16. Bellow Material	UNS N06625	UNS N06625	UNS N06625	UNS N06625
17. Valve Testing	API 527	API 527	API 527	API 527
18. Notes	Not Applicable	Not Applicable	Not Applicable	Not Applicable

Valve Code	PSV-CB-2-C21H	PSV-CB-2-C21J	PSV-CB-2-C21K	PSV-CB-2-C21L
Specs	C6 C9 C10 C19	C6 C9 C10 C19	C6 C9 C10 C19	C6 C9 C10 C19
1. Valve Type	Balanced	Balanced	Balanced	Balanced
2. Orifice Size	Orifice H (0.785 in ²)	Orifice J (1.287 in ²)	Orifice K (1.838 in ²)	Orifice L (2.853 in ²)
3. Valve Specification Level (VSL)	VSL-2	VSL-2	VSL-2	VSL-2
4. Standard	API 520	API 520	API 520	API 520
5. Inlet/Outlet Size Range (NPS)	2" x 3"	3" x 4"	3" x 4"	4" x 6"
6. Inlet/Outlet end connection	ASME B16.5, RF x ASME B16.5, RF	ASME B16.5, RF x ASME B16.5, RF	ASME B16.5, RF x ASME B16.5, RF	ASME B16.5, RF x ASME B16.5, RF
7. Inlet/Outlet pressure class	300 x 150	300 x 150	300 x 150	300 x 150
8. Temperature	-46°C to 240°C	-46°C to 240°C	-46°C to 240°C	-46°C to 240°C
9. Material Class	Carbon Steel	Carbon Steel	Carbon Steel	Carbon Steel
10. Body and bonnet Material	ASTM A352 Gr LCB	ASTM A352 Gr LCB	ASTM A352 Gr LCB	ASTM A352 Gr LCB
11. Disc Material	AISI 316 + Stellite	AISI 316 + Stellite	AISI 316 + Stellite	AISI 316 + Stellite
12. Nozzle Material	AISI 316	AISI 316	AISI 316	AISI 316
13. Guide Material	AISI 316	AISI 316	AISI 316	AISI 316
14. Spindle Material	Martensitic SS 400 Series	Martensitic SS 400 Series	Martensitic SS 400 Series	Martensitic SS 400 Series
15. Spring Material	UNS N07750	UNS N07750	UNS N07750	UNS N07750
16. Bellow Material	UNS N06625	UNS N06625	UNS N06625	UNS N06625
17. Valve Testing	API 527	API 527	API 527	API 527
18. Notes	Not Applicable	Not Applicable	Not Applicable	Not Applicable

Valve Code	PSV-CB-2-C21M	PSV-CB-2-C21N	PSV-CB-2-C21P	PSV-CB-2-C21Q
Specs	C6 C9 C10 C19	C6 C9 C10 C19	C6 C9 C10 C19	C6 C9 C10 C19
1. Valve Type	Balanced	Balanced	Balanced	Balanced
2. Orifice Size	Orifice M (3.60 in ²)	Orifice N (4.34 in ²)	Orifice P (6.38 in ²)	Orifice Q (11.05 in ²)
3. Valve Specification Level (VSL)	VSL-2	VSL-2	VSL-2	VSL-2
4. Standard	API 520	API 520	API 520	API 520
5. Inlet/Outlet Size Range (NPS)	4" x 6"	4" x 6"	4" x 6"	6" x 8"
6. Inlet/Outlet end connection	ASME B16.5, RF x ASME B16.5, RF	ASME B16.5, RF x ASME B16.5, RF	ASME B16.5, RF x ASME B16.5, RF	ASME B16.5, RF x ASME B16.5, RF
7. Inlet/Outlet pressure class	300 x 150	300 x 150	300 x 150	300 x 150
8. Temperature	-46°C to 240°C	-46°C to 240°C	-46°C to 240°C	-46°C to 240°C
9. Material Class	Carbon Steel	Carbon Steel	Carbon Steel	Carbon Steel
10. Body and bonnet Material	ASTM A352 Gr LCB	ASTM A352 Gr LCB	ASTM A352 Gr LCB	ASTM A352 Gr LCB
11. Disc Material	AISI 316 + Stellite	AISI 316 + Stellite	AISI 316 + Stellite	AISI 316 + Stellite
12. Nozzle Material	AISI 316	AISI 316	AISI 316	AISI 316
13. Guide Material	AISI 316	AISI 316	AISI 316	AISI 316
14. Spindle Material	Martensitic SS 400 Series	Martensitic SS 400 Series	Martensitic SS 400 Series	Martensitic SS 400 Series
15. Spring Material	UNS N07750	UNS N07750	UNS N07750	UNS N07750
16. Bellow Material	UNS N06625	UNS N06625	UNS N06625	UNS N06625
17. Valve Testing	API 527	API 527	API 527	API 527
18. Notes	Not Applicable	Not Applicable	Not Applicable	Not Applicable

Valve Code	PSV-CB-2-C21R	PSV-CB-2-C21T	PSV-CB-2-D21D	PSV-CB-2-D21E
Specs	C6 C9 C10 C19	C6 C9 C10 C19	C16	C16
1. Valve Type	Balanced	Balanced	Balanced	Balanced
2. Orifice Size	Orifice R (16.00 in ²)	Orifice T (26.00 in ²)	Orifice D (A=0.110 in ²)	Orifice E (0.196 in ²)
3. Valve Specification Level (VSL)	VSL-2	VSL-2	VSL-2	VSL-2
4. Standard	API 520	API 520	API 520	API 520
5. Inlet/Outlet Size Range (NPS)	6" x 10"	8" x 10"	1" x 2"	1" x 2"
6. Inlet/Outlet end connection	ASME B16.5, RF x ASME B16.5, RF	ASME B16.5, RF x ASME B16.5, RF	ASME B16.5, RF x ASME B16.5, RF	ASME B16.5, RF x ASME B16.5, RF
7. Inlet/Outlet pressure class	300 x 150	300 x 150	300 x 150	300 x 150
8. Temperature	-46°C to 240°C	-46°C to 240°C	-50°C to 100°C	-50°C to 100°C
9. Material Class	Carbon Steel	Carbon Steel	Duplex Steel	Duplex Steel
10. Body and bonnet Material	ASTM A352 Gr LCB	ASTM A352 Gr LCB	ASTM A995 Gr 4a	ASTM A995 Gr 4a
11. Disc Material	AISI 316 + Stellite	AISI 316 + Stellite	ASTM A479 (UNS S31803)	ASTM A479 (UNS S31803)
12. Nozzle Material	AISI 316	AISI 316	ASTM A479 (UNS S31803)	ASTM A479 (UNS S31803)
13. Guide Material	AISI 316	AISI 316	AISI 316	AISI 316
14. Spindle Material	Martensitic SS 400 Series	Martensitic SS 400 Series	Martensitic SS 400 Series	Martensitic SS 400 Series
15. Spring Material	UNS N07750	UNS N07750	UNS N07750	UNS N07750
16. Bellow Material	UNS N06625	UNS N06625	UNS N06625	UNS N06625
17. Valve Testing	API 527	API 527	API 527	API 527
18. Notes	Not Applicable	Not Applicable	Not Applicable	Not Applicable

Valve Code	PSV-CB-2-D21F	PSV-CB-2-D21G	PSV-CB-2-D21H	PSV-CB-2-D21J
Specs	C16	C16	C16	C16
1. Valve Type	Balanced	Balanced	Balanced	Balanced
2. Orifice Size	Orifice F (0.307 in ²)	Orifice G (0.503 in ²)	Orifice H (0.785 in ²)	Orifice J (1.287 in ²)
3. Valve Specification Level (VSL)	VSL-2	VSL-2	VSL-2	VSL-2
4. Standard	API 520	API 520	API 520	API 520
5. Inlet/Outlet Size Range (NPS)	1 ½" x 2"	1 ½" x 3"	2" x 3"	3" x 4"
6. Inlet/Outlet end connection	ASME B16.5, RF x ASME B16.5, RF	ASME B16.5, RF x ASME B16.5, RF	ASME B16.5, RF x ASME B16.5, RF	ASME B16.5, RF x ASME B16.5, RF
7. Inlet/Outlet pressure class	300 x 150	300 x 150	300 x 150	300 x 150
8. Temperature	-50°C to 100°C	-50°C to 100°C	-50°C to 100°C	-50°C to 100°C
9. Material Class	Duplex Steel	Duplex Steel	Duplex Steel	Duplex Steel
10. Body and bonnet Material	ASTM A995 Gr 4a	ASTM A995 Gr 4a	ASTM A995 Gr 4a	ASTM A995 Gr 4a
11. Disc Material	ASTM A479 (UNS S31803)	ASTM A479 (UNS S31803)	ASTM A479 (UNS S31803)	ASTM A479 (UNS S31803)
12. Nozzle Material	ASTM A479 (UNS S31803)	ASTM A479 (UNS S31803)	ASTM A479 (UNS S31803)	ASTM A479 (UNS S31803)
13. Guide Material	AISI 316	AISI 316	AISI 316	AISI 316
14. Spindle Material	Martensitic SS 400 Series	Martensitic SS 400 Series	Martensitic SS 400 Series	Martensitic SS 400 Series
15. Spring Material	UNS N07750	UNS N07750	UNS N07750	UNS N07750
16. Bellow Material	UNS N06625	UNS N06625	UNS N06625	UNS N06625
17. Valve Testing	API 527	API 527	API 527	API 527
18. Notes	Not Applicable	Not Applicable	Not Applicable	Not Applicable

Valve Code	PSV-CB-2-D21K	PSV-CB-2-D21L	PSV-CB-2-D21M	PSV-CB-2-D21N
Specs	C16	C16	C16	C16
1. Valve Type	Balanced	Balanced	Balanced	Balanced
2. Orifice Size	Orifice K (1.838 in ²)	Orifice L (2.853 in ²)	Orifice M (3.60 in ²)	Orifice N (4.34 in ²)
3. Valve Specification Level (VSL)	VSL-2	VSL-2	VSL-2	VSL-2
4. Standard	API 520	API 520	API 520	API 520
5. Inlet/Outlet Size Range (NPS)	3" x 4"	4" x 6"	4" x 6"	4" x 6"
6. Inlet/Outlet end connection	ASME B16.5, RF x ASME B16.5, RF	ASME B16.5, RF x ASME B16.5, RF	ASME B16.5, RF x ASME B16.5, RF	ASME B16.5, RF x ASME B16.5, RF
7. Inlet/Outlet pressure class	300 x 150	300 x 150	300 x 150	300 x 150
8. Temperature	-50°C to 100°C	-50°C to 100°C	-50°C to 100°C	-50°C to 100°C
9. Material Class	Duplex Steel	Duplex Steel	Duplex Steel	Duplex Steel
10. Body and bonnet Material	ASTM A995 Gr 4a	ASTM A995 Gr 4a	ASTM A995 Gr 4a	ASTM A995 Gr 4a
11. Disc Material	ASTM A479 (UNS S31803)	ASTM A479 (UNS S31803)	ASTM A479 (UNS S31803)	ASTM A479 (UNS S31803)
12. Nozzle Material	ASTM A479 (UNS S31803)	ASTM A479 (UNS S31803)	ASTM A479 (UNS S31803)	ASTM A479 (UNS S31803)
13. Guide Material	AISI 316	AISI 316	AISI 316	AISI 316
14. Spindle Material	Martensitic SS 400 Series	Martensitic SS 400 Series	Martensitic SS 400 Series	Martensitic SS 400 Series
15. Spring Material	UNS N07750	UNS N07750	UNS N07750	UNS N07750
16. Bellow Material	UNS N06625	UNS N06625	UNS N06625	UNS N06625
17. Valve Testing	API 527	API 527	API 527	API 527
18. Notes	Not Applicable	Not Applicable	Not Applicable	Not Applicable

Valve Code	PSV-CB-2-D21P	PSV-CB-2-D21Q	PSV-CB-2-D21R	PSV-CB-2-D21T
Specs	C16	C16	C16	C16
1. Valve Type	Balanced	Balanced	Balanced	Balanced
2. Orifice Size	Orifice P (6.38 in ²)	Orifice Q (11.05 in ²)	Orifice R (16.00 in ²)	Orifice T (26.00 in ²)
3. Valve Specification Level (VSL)	VSL-2	VSL-2	VSL-2	VSL-2
4. Standard	API 520	API 520	API 520	API 520
5. Inlet/Outlet Size Range (NPS)	4" x 6"	6" x 8"	6" x 10"	8" x 10"
6. Inlet/Outlet end connection	ASME B16.5, RF x ASME B16.5, RF	ASME B16.5, RF x ASME B16.5, RF	ASME B16.5, RF x ASME B16.5, RF	ASME B16.5, RF x ASME B16.5, RF
7. Inlet/Outlet pressure class	300 x 150	300 x 150	300 x 150	300 x 150
8. Temperature	-50°C to 100°C	-50°C to 100°C	-50°C to 100°C	-50°C to 100°C
9. Material Class	Duplex Steel	Duplex Steel	Duplex Steel	Duplex Steel
10. Body and bonnet Material	ASTM A995 Gr 4a	ASTM A995 Gr 4a	ASTM A995 Gr 4a	ASTM A995 Gr 4a
11. Disc Material	ASTM A479 (UNS S31803)	ASTM A479 (UNS S31803)	ASTM A479 (UNS S31803)	ASTM A479 (UNS S31803)
12. Nozzle Material	ASTM A479 (UNS S31803)	ASTM A479 (UNS S31803)	ASTM A479 (UNS S31803)	ASTM A479 (UNS S31803)
13. Guide Material	AISI 316	AISI 316	AISI 316	AISI 316
14. Spindle Material	Martensitic SS 400 Series	Martensitic SS 400 Series	Martensitic SS 400 Series	Martensitic SS 400 Series
15. Spring Material	UNS N07750	UNS N07750	UNS N07750	UNS N07750
16. Bellow Material	UNS N06625	UNS N06625	UNS N06625	UNS N06625
17. Valve Testing	API 527	API 527	API 527	API 527
18. Notes	Not Applicable	Not Applicable	Not Applicable	Not Applicable

Valve Code	PSV-CB-2-D31D	PSV-CB-2-D31E	PSV-CB-2-D31F	PSV-CB-2-D31G
Specs	C12	C12	C12	C12
1. Valve Type	Balanced	Balanced	Balanced	Balanced
2. Orifice Size	Orifice D (A=0.110 in ²)	Orifice E (0.196 in ²)	Orifice F (0.307 in ²)	Orifice G (0.503 in ²)
3. Valve Specification Level (VSL)	VSL-2	VSL-2	VSL-2	VSL-2
4. Standard	API 520	API 520	API 520	API 520
5. Inlet/Outlet Size Range (NPS)	1" x 2"	1" x 2"	1 ½" x 2"	1 ½" x 3"
6. Inlet/Outlet end connection	ASME B16.5, RF x ASME B16.5, RF	ASME B16.5, RF x ASME B16.5, RF	ASME B16.5, RF x ASME B16.5, RF	ASME B16.5, RF x ASME B16.5, RF
7. Inlet/Outlet pressure class	300 x 150	300 x 150	300 x 150	300 x 150
8. Temperature	-50°C to 110°C	-50°C to 110°C	-50°C to 110°C	-50°C to 110°C
9. Material Class	Duplex Steel	Duplex Steel	Duplex Steel	Duplex Steel
10. Body and bonnet Material	ASTM A995 Gr 6a	ASTM A995 Gr 6a	ASTM A995 Gr 6a	ASTM A995 Gr 6a
11. Disc Material	ASTM A479 (UNS S32760)	ASTM A479 (UNS S32760)	ASTM A479 (UNS S32760)	ASTM A479 (UNS S32760)
12. Nozzle Material	ASTM A479 (UNS S32760)	ASTM A479 (UNS S32760)	ASTM A479 (UNS S32760)	ASTM A479 (UNS S32760)
13. Guide Material	AISI 316	AISI 316	AISI 316	AISI 316
14. Spindle Material	Martensitic SS 400 Series	Martensitic SS 400 Series	Martensitic SS 400 Series	Martensitic SS 400 Series
15. Spring Material	UNS N07750	UNS N07750	UNS N07750	UNS N07750
16. Bellow Material	UNS N06625	UNS N06625	UNS N06625	UNS N06625
17. Valve Testing	API 527	API 527	API 527	API 527
18. Notes	Not Applicable	Not Applicable	Not Applicable	Not Applicable

Valve Code	PSV-CB-2-D31H	PSV-CB-2-D31J	PSV-CB-2-D31K	PSV-CB-2-D31L
Specs	C12	C12	C12	C12
1. Valve Type	Balanced	Balanced	Balanced	Balanced
2. Orifice Size	Orifice H (0.785 in ²)	Orifice J (1.287 in ²)	Orifice K (1.838 in ²)	Orifice L (2.853 in ²)
3. Valve Specification Level (VSL)	VSL-2	VSL-2	VSL-2	VSL-2
4. Standard	API 520	API 520	API 520	API 520
5. Inlet/Outlet Size Range (NPS)	2" x 3"	3" x 4"	3" x 4"	4" x 6"
6. Inlet/Outlet end connection	ASME B16.5, RF x ASME B16.5, RF	ASME B16.5, RF x ASME B16.5, RF	ASME B16.5, RF x ASME B16.5, RF	ASME B16.5, RF x ASME B16.5, RF
7. Inlet/Outlet pressure class	300 x 150	300 x 150	300 x 150	300 x 150
8. Temperature	-50°C to 110°C	-50°C to 110°C	-50°C to 110°C	-50°C to 110°C
9. Material Class	Duplex Steel	Duplex Steel	Duplex Steel	Duplex Steel
10. Body and bonnet Material	ASTM A995 Gr 6a	ASTM A995 Gr 6a	ASTM A995 Gr 6a	ASTM A995 Gr 6a
11. Disc Material	ASTM A479 (UNS S32760)	ASTM A479 (UNS S32760)	ASTM A479 (UNS S32760)	ASTM A479 (UNS S32760)
12. Nozzle Material	ASTM A479 (UNS S32760)	ASTM A479 (UNS S32760)	ASTM A479 (UNS S32760)	ASTM A479 (UNS S32760)
13. Guide Material	AISI 316	AISI 316	AISI 316	AISI 316
14. Spindle Material	Martensitic SS 400 Series	Martensitic SS 400 Series	Martensitic SS 400 Series	Martensitic SS 400 Series
15. Spring Material	UNS N07750	UNS N07750	UNS N07750	UNS N07750
16. Bellow Material	UNS N06625	UNS N06625	UNS N06625	UNS N06625
17. Valve Testing	API 527	API 527	API 527	API 527
18. Notes	Not Applicable	Not Applicable	Not Applicable	Not Applicable

Valve Code	PSV-CB-2-D31M	PSV-CB-2-D31N	PSV-CB-2-D31P	PSV-CB-2-D31Q
Specs	C12	C12	C12	C12
1. Valve Type	Balanced	Balanced	Balanced	Balanced
2. Orifice Size	Orifice M (3.60 in ²)	Orifice N (4.34 in ²)	Orifice P (6.38 in ²)	Orifice Q (11.05 in ²)
3. Valve Specification Level (VSL)	VSL-2	VSL-2	VSL-2	VSL-2
4. Standard	API 520	API 520	API 520	API 520
5. Inlet/Outlet Size Range (NPS)	4" x 6"	4" x 6"	4" x 6"	6" x 8"
6. Inlet/Outlet end connection	ASME B16.5, RF x ASME B16.5, RF	ASME B16.5, RF x ASME B16.5, RF	ASME B16.5, RF x ASME B16.5, RF	ASME B16.5, RF x ASME B16.5, RF
7. Inlet/Outlet pressure class	300 x 150	300 x 150	300 x 150	300 x 150
8. Temperature	-50°C to 110°C	-50°C to 110°C	-50°C to 110°C	-50°C to 110°C
9. Material Class	Duplex Steel	Duplex Steel	Duplex Steel	Duplex Steel
10. Body and bonnet Material	ASTM A995 Gr 6a	ASTM A995 Gr 6a	ASTM A995 Gr 6a	ASTM A995 Gr 6a
11. Disc Material	ASTM A479 (UNS S32760)	ASTM A479 (UNS S32760)	ASTM A479 (UNS S32760)	ASTM A479 (UNS S32760)
12. Nozzle Material	ASTM A479 (UNS S32760)	ASTM A479 (UNS S32760)	ASTM A479 (UNS S32760)	ASTM A479 (UNS S32760)
13. Guide Material	AISI 316	AISI 316	AISI 316	AISI 316
14. Spindle Material	Martensitic SS 400 Series	Martensitic SS 400 Series	Martensitic SS 400 Series	Martensitic SS 400 Series
15. Spring Material	UNS N07750	UNS N07750	UNS N07750	UNS N07750
16. Bellow Material	UNS N06625	UNS N06625	UNS N06625	UNS N06625
17. Valve Testing	API 527	API 527	API 527	API 527
18. Notes	Not Applicable	Not Applicable	Not Applicable	Not Applicable

Valve Code	PSV-CB-2-D31R	PSV-CB-2-D31T	PSV-CB-2-N11D	PSV-CB-2-N11E
Specs	C12	C12	C30	C30
1. Valve Type	Balanced	Balanced	Balanced	Balanced
2. Orifice Size	Orifice R (16.00 in ²)	Orifice T (26.00 in ²)	Orifice D (A=0.110 in ²)	Orifice E (0.196 in ²)
3. Valve Specification Level (VSL)	VSL-2	VSL-2	VSL-2	VSL-2
4. Standard	API 520	API 520	API 520	API 520
5. Inlet/Outlet Size Range (NPS)	6" x 10"	8" x 10"	1" x 2"	1" x 2"
6. Inlet/Outlet end connection	ASME B16.5, RF x ASME B16.5, RF	ASME B16.5, RF x ASME B16.5, RF	ASME B16.5, RF x ASME B16.5, RF	ASME B16.5, RF x ASME B16.5, RF
7. Inlet/Outlet pressure class	300 x 150	300 x 150	300 x 150	300 x 150
8. Temperature	-50°C to 110°C	-50°C to 110°C	-100°C to 155°C	-100°C to 155°C
9. Material Class	Duplex Steel	Duplex Steel	Nickel Alloys	Nickel Alloys
10. Body and bonnet Material	ASTM A995 Gr 6a	ASTM A995 Gr 6a	UNS N06625	UNS N06625
11. Disc Material	ASTM A479 (UNS S32760)	ASTM A479 (UNS S32760)	UNS N06625	UNS N06625
12. Nozzle Material	ASTM A479 (UNS S32760)	ASTM A479 (UNS S32760)	ASTM B564 (UNS N06625)	ASTM B564 (UNS N06625)
13. Guide Material	AISI 316	AISI 316	AISI 316	AISI 316
14. Spindle Material	Martensitic SS 400 Series	Martensitic SS 400 Series	Martensitic SS 400 Series	Martensitic SS 400 Series
15. Spring Material	UNS N07750	UNS N07750	UNS N07750	UNS N07750
16. Bellow Material	UNS N06625	UNS N06625	UNS N06625	UNS N06625
17. Valve Testing	API 527	API 527	API 527	API 527
18. Notes	Not Applicable	Not Applicable	Not Applicable	Not Applicable

Valve Code	PSV-CB-2-N11F	PSV-CB-2-N11G	PSV-CB-2-N11H	PSV-CB-2-N11J
Specs	C30	C30	C30	C30
1. Valve Type	Balanced	Balanced	Balanced	Balanced
2. Orifice Size	Orifice F (0.307 in ²)	Orifice G (0.503 in ²)	Orifice H (0.785 in ²)	Orifice J (1.287 in ²)
3. Valve Specification Level (VSL)	VSL-2	VSL-2	VSL-2	VSL-2
4. Standard	API 520	API 520	API 520	API 520
5. Inlet/Outlet Size Range (NPS)	1 ½" x 2"	1 ½" x 3"	2" x 3"	3" x 4"
6. Inlet/Outlet end connection	ASME B16.5, RF x ASME B16.5, RF	ASME B16.5, RF x ASME B16.5, RF	ASME B16.5, RF x ASME B16.5, RF	ASME B16.5, RF x ASME B16.5, RF
7. Inlet/Outlet pressure class	300 x 150	300 x 150	300 x 150	300 x 150
8. Temperature	-100°C to 155°C	-100°C to 155°C	-100°C to 155°C	-100°C to 155°C
9. Material Class	Nickel Alloys	Nickel Alloys	Nickel Alloys	Nickel Alloys
10. Body and bonnet Material	UNS N06625	UNS N06625	UNS N06625	UNS N06625
11. Disc Material	UNS N06625	UNS N06625	UNS N06625	UNS N06625
12. Nozzle Material	ASTM B564 (UNS N06625)	ASTM B564 (UNS N06625)	ASTM B564 (UNS N06625)	ASTM B564 (UNS N06625)
13. Guide Material	AISI 316	AISI 316	AISI 316	AISI 316
14. Spindle Material	Martensitic SS 400 Series	Martensitic SS 400 Series	Martensitic SS 400 Series	Martensitic SS 400 Series
15. Spring Material	UNS N07750	UNS N07750	UNS N07750	UNS N07750
16. Bellow Material	UNS N06625	UNS N06625	UNS N06625	UNS N06625
17. Valve Testing	API 527	API 527	API 527	API 527
18. Notes	Not Applicable	Not Applicable	Not Applicable	Not Applicable

Valve Code	PSV-CB-2-N11K	PSV-CB-2-N11L	PSV-CB-2-N11M	PSV-CB-2-N11N
Specs	C30	C30	C30	C30
1. Valve Type	Balanced	Balanced	Balanced	Balanced
2. Orifice Size	Orifice K (1.838 in ²)	Orifice L (2.853 in ²)	Orifice M (3.60 in ²)	Orifice N (4.34 in ²)
3. Valve Specification Level (VSL)	VSL-2	VSL-2	VSL-2	VSL-2
4. Standard	API 520	API 520	API 520	API 520
5. Inlet/Outlet Size Range (NPS)	3" x 4"	4" x 6"	4" x 6"	4" x 6"
6. Inlet/Outlet end connection	ASME B16.5, RF x ASME B16.5, RF	ASME B16.5, RF x ASME B16.5, RF	ASME B16.5, RF x ASME B16.5, RF	ASME B16.5, RF x ASME B16.5, RF
7. Inlet/Outlet pressure class	300 x 150	300 x 150	300 x 150	300 x 150
8. Temperature	-100°C to 155°C	-100°C to 155°C	-100°C to 155°C	-100°C to 155°C
9. Material Class	Nickel Alloys	Nickel Alloys	Nickel Alloys	Nickel Alloys
10. Body and bonnet Material	UNS N06625	UNS N06625	UNS N06625	UNS N06625
11. Disc Material	UNS N06625	UNS N06625	UNS N06625	UNS N06625
12. Nozzle Material	ASTM B564 (UNS N06625)	ASTM B564 (UNS N06625)	ASTM B564 (UNS N06625)	ASTM B564 (UNS N06625)
13. Guide Material	AISI 316	AISI 316	AISI 316	AISI 316
14. Spindle Material	Martensitic SS 400 Series	Martensitic SS 400 Series	Martensitic SS 400 Series	Martensitic SS 400 Series
15. Spring Material	UNS N07750	UNS N07750	UNS N07750	UNS N07750
16. Bellow Material	UNS N06625	UNS N06625	UNS N06625	UNS N06625
17. Valve Testing	API 527	API 527	API 527	API 527
18. Notes	Not Applicable	Not Applicable	Not Applicable	Not Applicable

Valve Code	PSV-CB-2-N11P	PSV-CB-2-N11Q	PSV-CB-2-N11R	PSV-CB-2-N11T
Specs	C30	C30	C30	C30
1. Valve Type	Balanced	Balanced	Balanced	Balanced
2. Orifice Size	Orifice P (6.38 in ²)	Orifice Q (11.05 in ²)	Orifice R (16.00 in ²)	Orifice T (26.00 in ²)
3. Valve Specification Level (VSL)	VSL-2	VSL-2	VSL-2	VSL-2
4. Standard	API 520	API 520	API 520	API 520
5. Inlet/Outlet Size Range (NPS)	4" x 6"	6" x 8"	6" x 10"	8" x 10"
6. Inlet/Outlet end connection	ASME B16.5, RF x ASME B16.5, RF	ASME B16.5, RF x ASME B16.5, RF	ASME B16.5, RF x ASME B16.5, RF	ASME B16.5, RF x ASME B16.5, RF
7. Inlet/Outlet pressure class	300 x 150	300 x 150	300 x 150	300 x 150
8. Temperature	-100°C to 155°C	-100°C to 155°C	-100°C to 155°C	-100°C to 155°C
9. Material Class	Nickel Alloys	Nickel Alloys	Nickel Alloys	Nickel Alloys
10. Body and bonnet Material	UNS N06625	UNS N06625	UNS N06625	UNS N06625
11. Disc Material	UNS N06625	UNS N06625	UNS N06625	UNS N06625
12. Nozzle Material	ASTM B564 (UNS N06625)	ASTM B564 (UNS N06625)	ASTM B564 (UNS N06625)	ASTM B564 (UNS N06625)
13. Guide Material	AISI 316	AISI 316	AISI 316	AISI 316
14. Spindle Material	Martensitic SS 400 Series	Martensitic SS 400 Series	Martensitic SS 400 Series	Martensitic SS 400 Series
15. Spring Material	UNS N07750	UNS N07750	UNS N07750	UNS N07750
16. Bellow Material	UNS N06625	UNS N06625	UNS N06625	UNS N06625
17. Valve Testing	API 527	API 527	API 527	API 527
18. Notes	Not Applicable	Not Applicable	Not Applicable	Not Applicable

Valve Code	PSV-CB-2-S21D	PSV-CB-2-S21E	PSV-CB-2-S21F	PSV-CB-2-S21G
Specs	C3 C9 C10	C3 C9 C10	C3 C9 C10	C3 C9 C10
1. Valve Type	Balanced	Balanced	Balanced	Balanced
2. Orifice Size	Orifice D (A=0.110 in ²)	Orifice E (0.196 in ²)	Orifice F (0.307 in ²)	Orifice G (0.503 in ²)
3. Valve Specification Level (VSL)	VSL-2	VSL-2	VSL-2	VSL-2
4. Standard	API 520	API 520	API 520	API 520
5. Inlet/Outlet Size Range (NPS)	1" x 2"	1" x 2"	1 ½" x 2"	1 ½" x 3"
6. Inlet/Outlet end connection	ASME B16.5, RF x ASME B16.5, RF	ASME B16.5, RF x ASME B16.5, RF	ASME B16.5, RF x ASME B16.5, RF	ASME B16.5, RF x ASME B16.5, RF
7. Inlet/Outlet pressure class	300 x 150	300 x 150	300 x 150	300 x 150
8. Temperature	-100°C to 260°C	-100°C to 260°C	-100°C to 260°C	-100°C to 260°C
9. Material Class	Stainless Steel	Stainless Steel	Stainless Steel	Stainless Steel
10. Body and bonnet Material	ASTM A182 Gr CF8M	ASTM A182 Gr CF8M	ASTM A182 Gr CF8M	ASTM A182 Gr CF8M
11. Disc Material	AISI 316 + Stellite	AISI 316 + Stellite	AISI 316 + Stellite	AISI 316 + Stellite
12. Nozzle Material	AISI 316	AISI 316	AISI 316	AISI 316
13. Guide Material	AISI 316	AISI 316	AISI 316	AISI 316
14. Spindle Material	Martensitic SS 400 Series	Martensitic SS 400 Series	Martensitic SS 400 Series	Martensitic SS 400 Series
15. Spring Material	UNS N07750	UNS N07750	UNS N07750	UNS N07750
16. Bellow Material	UNS N06625	UNS N06625	UNS N06625	UNS N06625
17. Valve Testing	API 527	API 527	API 527	API 527
18. Notes	Not Applicable	Not Applicable	Not Applicable	Not Applicable

Valve Code	PSV-CB-2-S21H	PSV-CB-2-S21J	PSV-CB-2-S21K	PSV-CB-2-S21L
Specs	C3 C9 C10	C3 C9 C10	C3 C9 C10	C3 C9 C10
1. Valve Type	Balanced	Balanced	Balanced	Balanced
2. Orifice Size	Orifice H (0.785 in ²)	Orifice J (1.287 in ²)	Orifice K (1.838 in ²)	Orifice L (2.853 in ²)
3. Valve Specification Level (VSL)	VSL-2	VSL-2	VSL-2	VSL-2
4. Standard	API 520	API 520	API 520	API 520
5. Inlet/Outlet Size Range (NPS)	2" x 3"	3" x 4"	3" x 4"	4" x 6"
6. Inlet/Outlet end connection	ASME B16.5, RF x ASME B16.5, RF	ASME B16.5, RF x ASME B16.5, RF	ASME B16.5, RF x ASME B16.5, RF	ASME B16.5, RF x ASME B16.5, RF
7. Inlet/Outlet pressure class	300 x 150	300 x 150	300 x 150	300 x 150
8. Temperature	-100°C to 260°C	-100°C to 260°C	-100°C to 260°C	-100°C to 260°C
9. Material Class	Stainless Steel	Stainless Steel	Stainless Steel	Stainless Steel
10. Body and bonnet Material	ASTM A182 Gr CF8M	ASTM A182 Gr CF8M	ASTM A182 Gr CF8M	ASTM A182 Gr CF8M
11. Disc Material	AISI 316 + Stellite	AISI 316 + Stellite	AISI 316 + Stellite	AISI 316 + Stellite
12. Nozzle Material	AISI 316	AISI 316	AISI 316	AISI 316
13. Guide Material	AISI 316	AISI 316	AISI 316	AISI 316
14. Spindle Material	Martensitic SS 400 Series	Martensitic SS 400 Series	Martensitic SS 400 Series	Martensitic SS 400 Series
15. Spring Material	UNS N07750	UNS N07750	UNS N07750	UNS N07750
16. Bellow Material	UNS N06625	UNS N06625	UNS N06625	UNS N06625
17. Valve Testing	API 527	API 527	API 527	API 527
18. Notes	Not Applicable	Not Applicable	Not Applicable	Not Applicable

Valve Code	PSV-CB-2-S21M	PSV-CB-2-S21N	PSV-CB-2-S21P	PSV-CB-2-S21Q
Specs	C3 C9 C10	C3 C9 C10	C3 C9 C10	C3 C9 C10
1. Valve Type	Balanced	Balanced	Balanced	Balanced
2. Orifice Size	Orifice M (3.60 in ²)	Orifice N (4.34 in ²)	Orifice P (6.38 in ²)	Orifice Q (11.05 in ²)
3. Valve Specification Level (VSL)	VSL-2	VSL-2	VSL-2	VSL-2
4. Standard	API 520	API 520	API 520	API 520
5. Inlet/Outlet Size Range (NPS)	4" x 6"	4" x 6"	4" x 6"	6" x 8"
6. Inlet/Outlet end connection	ASME B16.5, RF x ASME B16.5, RF	ASME B16.5, RF x ASME B16.5, RF	ASME B16.5, RF x ASME B16.5, RF	ASME B16.5, RF x ASME B16.5, RF
7. Inlet/Outlet pressure class	300 x 150	300 x 150	300 x 150	300 x 150
8. Temperature	-100°C to 260°C	-100°C to 260°C	-100°C to 260°C	-100°C to 260°C
9. Material Class	Stainless Steel	Stainless Steel	Stainless Steel	Stainless Steel
10. Body and bonnet Material	ASTM A182 Gr CF8M	ASTM A182 Gr CF8M	ASTM A182 Gr CF8M	ASTM A182 Gr CF8M
11. Disc Material	AISI 316 + Stellite	AISI 316 + Stellite	AISI 316 + Stellite	AISI 316 + Stellite
12. Nozzle Material	AISI 316	AISI 316	AISI 316	AISI 316
13. Guide Material	AISI 316	AISI 316	AISI 316	AISI 316
14. Spindle Material	Martensitic SS 400 Series	Martensitic SS 400 Series	Martensitic SS 400 Series	Martensitic SS 400 Series
15. Spring Material	UNS N07750	UNS N07750	UNS N07750	UNS N07750
16. Bellow Material	UNS N06625	UNS N06625	UNS N06625	UNS N06625
17. Valve Testing	API 527	API 527	API 527	API 527
18. Notes	Not Applicable	Not Applicable	Not Applicable	Not Applicable

Valve Code	PSV-CB-2-S21R	PSV-CB-2-S21T	PSV-EB-1-C10D	PSV-EB-1-C10E
Specs	C3 C9 C10	C3 C9 C10	E9 E10	E9 E10
1. Valve Type	Balanced	Balanced	Conventional	Conventional
2. Orifice Size	Orifice R (16.00 in ²)	Orifice T (26.00 in ²)	Orifice D (A=0.110 in ²)	Orifice E (0.196 in ²)
3. Valve Specification Level (VSL)	VSL-2	VSL-2	VSL-1	VSL-1
4. Standard	API 520	API 520	API 520	API 520
5. Inlet/Outlet Size Range (NPS)	6" x 10"	8" x 10"	1" x 2"	1" x 2"
6. Inlet/Outlet end connection	ASME B16.5, RF x ASME B16.5, RF	ASME B16.5, RF x ASME B16.5, RF	ASME B16.5, RF x ASME B16.5, RF	ASME B16.5, RF x ASME B16.5, RF
7. Inlet/Outlet pressure class	300 x 150	300 x 150	600 x 150	600 x 150
8. Temperature	-100°C to 260°C	-100°C to 260°C	0°C to 240°C	0°C to 240°C
9. Material Class	Stainless Steel	Stainless Steel	Carbon Steel	Carbon Steel
10. Body and bonnet Material	ASTM A182 Gr CF8M	ASTM A182 Gr CF8M	ASTM A216 Gr WCB	ASTM A216 Gr WCB
11. Disc Material	AISI 316 + Stellite	AISI 316 + Stellite	Martensitic SS 400 Series	Martensitic SS 400 Series
12. Nozzle Material	AISI 316	AISI 316	AISI 316	AISI 316
13. Guide Material	AISI 316	AISI 316	AISI 316	AISI 316
14. Spindle Material	Martensitic SS 400 Series	Martensitic SS 400 Series	Martensitic SS 400 Series	Martensitic SS 400 Series
15. Spring Material	UNS N07750	UNS N07750	UNS N07750	UNS N07750
16. Bellow Material	UNS N06625	UNS N06625	Not applicable	Not applicable
17. Valve Testing	API 527	API 527	API 527	API 527
18. Notes	Not Applicable	Not Applicable	Not Applicable	Not Applicable

Valve Code	PSV-EB-1-C10F	PSV-EB-1-C10G	PSV-EB-1-C10H	PSV-EB-1-C10J
Specs	E9 E10	E9 E10	E9 E10	E9 E10
1. Valve Type	Conventional	Conventional	Conventional	Conventional
2. Orifice Size	Orifice F (0.307 in ²)	Orifice G (0.503 in ²)	Orifice H (0.785 in ²)	Orifice J (1.287 in ²)
3. Valve Specification Level (VSL)	VSL-1	VSL-1	VSL-1	VSL-1
4. Standard	API 520	API 520	API 520	API 520
5. Inlet/Outlet Size Range (NPS)	1 ½" x 2"	1 ½" x 3"	2" x 3"	3" x 4"
6. Inlet/Outlet end connection	ASME B16.5, RF x ASME B16.5, RF	ASME B16.5, RF x ASME B16.5, RF	ASME B16.5, RF x ASME B16.5, RF	ASME B16.5, RF x ASME B16.5, RF
7. Inlet/Outlet pressure class	600 x 150	600 x 150	600 x 150	600 x 150
8. Temperature	0°C to 240°C	0°C to 240°C	0°C to 240°C	0°C to 240°C
9. Material Class	Carbon Steel	Carbon Steel	Carbon Steel	Carbon Steel
10. Body and bonnet Material	ASTM A216 Gr WCB	ASTM A216 Gr WCB	ASTM A216 Gr WCB	ASTM A216 Gr WCB
11. Disc Material	Martensitic SS 400 Series	Martensitic SS 400 Series	Martensitic SS 400 Series	Martensitic SS 400 Series
12. Nozzle Material	AISI 316	AISI 316	AISI 316	AISI 316
13. Guide Material	AISI 316	AISI 316	AISI 316	AISI 316
14. Spindle Material	Martensitic SS 400 Series	Martensitic SS 400 Series	Martensitic SS 400 Series	Martensitic SS 400 Series
15. Spring Material	UNS N07750	UNS N07750	UNS N07750	UNS N07750
16. Bellow Material	Not applicable	Not applicable	Not applicable	Not applicable
17. Valve Testing	API 527	API 527	API 527	API 527
18. Notes	Not Applicable	Not Applicable	Not Applicable	Not Applicable

Valve Code	PSV-EB-1-C10K	PSV-EB-1-C10L	PSV-EB-1-C10M	PSV-EB-1-C10N
Specs	E9 E10	E9 E10	E9 E10	E9 E10
1. Valve Type	Conventional	Conventional	Conventional	Conventional
2. Orifice Size	Orifice K (1.838 in ²)	Orifice L (2.853 in ²)	Orifice M (3.60 in ²)	Orifice N (4.34 in ²)
3. Valve Specification Level (VSL)	VSL-1	VSL-1	VSL-1	VSL-1
4. Standard	API 520	API 520	API 520	API 520
5. Inlet/Outlet Size Range (NPS)	3" x 4"	4" x 6"	4" x 6"	4" x 6"
6. Inlet/Outlet end connection	ASME B16.5, RF x ASME B16.5, RF	ASME B16.5, RF x ASME B16.5, RF	ASME B16.5, RF x ASME B16.5, RF	ASME B16.5, RF x ASME B16.5, RF
7. Inlet/Outlet pressure class	600 x 150	600 x 150	600 x 150	600 x 150
8. Temperature	0°C to 240°C	0°C to 240°C	0°C to 240°C	0°C to 240°C
9. Material Class	Carbon Steel	Carbon Steel	Carbon Steel	Carbon Steel
10. Body and bonnet Material	ASTM A216 Gr WCB	ASTM A216 Gr WCB	ASTM A216 Gr WCB	ASTM A216 Gr WCB
11. Disc Material	Martensitic SS 400 Series	Martensitic SS 400 Series	Martensitic SS 400 Series	Martensitic SS 400 Series
12. Nozzle Material	AISI 316	AISI 316	AISI 316	AISI 316
13. Guide Material	AISI 316	AISI 316	AISI 316	AISI 316
14. Spindle Material	Martensitic SS 400 Series	Martensitic SS 400 Series	Martensitic SS 400 Series	Martensitic SS 400 Series
15. Spring Material	UNS N07750	UNS N07750	UNS N07750	UNS N07750
16. Bellow Material	Not applicable	Not applicable	Not applicable	Not applicable
17. Valve Testing	API 527	API 527	API 527	API 527
18. Notes	Not Applicable	Not Applicable	Not Applicable	Not Applicable

Valve Code	PSV-EB-1-C10P	PSV-EB-1-C10Q	PSV-EB-1-C10R	PSV-EB-1-C10T
Specs	E9 E10	E9 E10	E9 E10	E9 E10
1. Valve Type	Conventional	Conventional	Conventional	Conventional
2. Orifice Size	Orifice P (6.38 in ²)	Orifice Q (11.05 in ²)	Orifice R (16.00 in ²)	Orifice T (26.00 in ²)
3. Valve Specification Level (VSL)	VSL-1	VSL-1	VSL-1	VSL-1
4. Standard	API 520	API 520	API 520	API 520
5. Inlet/Outlet Size Range (NPS)	4" x 6"	6" x 8"	6" x 10"	8" x 10"
6. Inlet/Outlet end connection	ASME B16.5, RF x ASME B16.5, RF	ASME B16.5, RF x ASME B16.5, RF	ASME B16.5, RF x ASME B16.5, RF	ASME B16.5, RF x ASME B16.5, RF
7. Inlet/Outlet pressure class	600 x 150	600 x 150	600 x 150	600 x 150
8. Temperature	0°C to 240°C	0°C to 240°C	0°C to 240°C	0°C to 240°C
9. Material Class	Carbon Steel	Carbon Steel	Carbon Steel	Carbon Steel
10. Body and bonnet Material	ASTM A216 Gr WCB	ASTM A216 Gr WCB	ASTM A216 Gr WCB	ASTM A216 Gr WCB
11. Disc Material	Martensitic SS 400 Series	Martensitic SS 400 Series	Martensitic SS 400 Series	Martensitic SS 400 Series
12. Nozzle Material	AISI 316	AISI 316	AISI 316	AISI 316
13. Guide Material	AISI 316	AISI 316	AISI 316	AISI 316
14. Spindle Material	Martensitic SS 400 Series	Martensitic SS 400 Series	Martensitic SS 400 Series	Martensitic SS 400 Series
15. Spring Material	UNS N07750	UNS N07750	UNS N07750	UNS N07750
16. Bellow Material	Not applicable	Not applicable	Not applicable	Not applicable
17. Valve Testing	API 527	API 527	API 527	API 527
18. Notes	Not Applicable	Not Applicable	Not Applicable	Not Applicable

Valve Code	PSV-EB-1-C11D	PSV-EB-1-C11E	PSV-EB-1-C11F	PSV-EB-1-C11G
Specs	E9 E10	E9 E10	E9 E10	E9 E10
1. Valve Type	Balanced	Balanced	Balanced	Balanced
2. Orifice Size	Orifice D (A=0.110 in ²)	Orifice E (0.196 in ²)	Orifice F (0.307 in ²)	Orifice G (0.503 in ²)
3. Valve Specification Level (VSL)	VSL-1	VSL-1	VSL-1	VSL-1
4. Standard	API 520	API 520	API 520	API 520
5. Inlet/Outlet Size Range (NPS)	1" x 2"	1" x 2"	1 ½" x 2"	1 ½" x 3"
6. Inlet/Outlet end connection	ASME B16.5, RF x ASME B16.5, RF	ASME B16.5, RF x ASME B16.5, RF	ASME B16.5, RF x ASME B16.5, RF	ASME B16.5, RF x ASME B16.5, RF
7. Inlet/Outlet pressure class	600 x 150	600 x 150	600 x 150	600 x 150
8. Temperature	0°C to 240°C	0°C to 240°C	0°C to 240°C	0°C to 240°C
9. Material Class	Carbon Steel	Carbon Steel	Carbon Steel	Carbon Steel
10. Body and bonnet Material	ASTM A216 Gr WCB	ASTM A216 Gr WCB	ASTM A216 Gr WCB	ASTM A216 Gr WCB
11. Disc Material	Martensitic SS 400 Series	Martensitic SS 400 Series	Martensitic SS 400 Series	Martensitic SS 400 Series
12. Nozzle Material	AISI 316	AISI 316	AISI 316	AISI 316
13. Guide Material	AISI 316	AISI 316	AISI 316	AISI 316
14. Spindle Material	Martensitic SS 400 Series	Martensitic SS 400 Series	Martensitic SS 400 Series	Martensitic SS 400 Series
15. Spring Material	UNS N07750	UNS N07750	UNS N07750	UNS N07750
16. Bellow Material	UNS N06625	UNS N06625	UNS N06625	UNS N06625
17. Valve Testing	API 527	API 527	API 527	API 527
18. Notes	Not Applicable	Not Applicable	Not Applicable	Not Applicable

Valve Code	PSV-EB-1-C11H	PSV-EB-1-C11J	PSV-EB-1-C11K	PSV-EB-1-C11L
Specs	E9 E10	E9 E10	E9 E10	E9 E10
1. Valve Type	Balanced	Balanced	Balanced	Balanced
2. Orifice Size	Orifice H (0.785 in ²)	Orifice J (1.287 in ²)	Orifice K (1.838 in ²)	Orifice L (2.853 in ²)
3. Valve Specification Level (VSL)	VSL-1	VSL-1	VSL-1	VSL-1
4. Standard	API 520	API 520	API 520	API 520
5. Inlet/Outlet Size Range (NPS)	2" x 3"	3" x 4"	3" x 4"	4" x 6"
6. Inlet/Outlet end connection	ASME B16.5, RF x ASME B16.5, RF	ASME B16.5, RF x ASME B16.5, RF	ASME B16.5, RF x ASME B16.5, RF	ASME B16.5, RF x ASME B16.5, RF
7. Inlet/Outlet pressure class	600 x 150	600 x 150	600 x 150	600 x 150
8. Temperature	0°C to 240°C	0°C to 240°C	0°C to 240°C	0°C to 240°C
9. Material Class	Carbon Steel	Carbon Steel	Carbon Steel	Carbon Steel
10. Body and bonnet Material	ASTM A216 Gr WCB	ASTM A216 Gr WCB	ASTM A216 Gr WCB	ASTM A216 Gr WCB
11. Disc Material	Martensitic SS 400 Series	Martensitic SS 400 Series	Martensitic SS 400 Series	Martensitic SS 400 Series
12. Nozzle Material	AISI 316	AISI 316	AISI 316	AISI 316
13. Guide Material	AISI 316	AISI 316	AISI 316	AISI 316
14. Spindle Material	Martensitic SS 400 Series	Martensitic SS 400 Series	Martensitic SS 400 Series	Martensitic SS 400 Series
15. Spring Material	UNS N07750	UNS N07750	UNS N07750	UNS N07750
16. Bellow Material	UNS N06625	UNS N06625	UNS N06625	UNS N06625
17. Valve Testing	API 527	API 527	API 527	API 527
18. Notes	Not Applicable	Not Applicable	Not Applicable	Not Applicable

Valve Code	PSV-EB-1-C11M	PSV-EB-1-C11N	PSV-EB-1-C11P	PSV-EB-1-C11Q
Specs	E9 E10	E9 E10	E9 E10	E9 E10
1. Valve Type	Balanced	Balanced	Balanced	Balanced
2. Orifice Size	Orifice M (3.60 in ²)	Orifice N (4.34 in ²)	Orifice P (6.38 in ²)	Orifice Q (11.05 in ²)
3. Valve Specification Level (VSL)	VSL-1	VSL-1	VSL-1	VSL-1
4. Standard	API 520	API 520	API 520	API 520
5. Inlet/Outlet Size Range (NPS)	4" x 6"	4" x 6"	4" x 6"	6" x 8"
6. Inlet/Outlet end connection	ASME B16.5, RF x ASME B16.5, RF	ASME B16.5, RF x ASME B16.5, RF	ASME B16.5, RF x ASME B16.5, RF	ASME B16.5, RF x ASME B16.5, RF
7. Inlet/Outlet pressure class	600 x 150	600 x 150	600 x 150	600 x 150
8. Temperature	0°C to 240°C	0°C to 240°C	0°C to 240°C	0°C to 240°C
9. Material Class	Carbon Steel	Carbon Steel	Carbon Steel	Carbon Steel
10. Body and bonnet Material	ASTM A216 Gr WCB	ASTM A216 Gr WCB	ASTM A216 Gr WCB	ASTM A216 Gr WCB
11. Disc Material	Martensitic SS 400 Series	Martensitic SS 400 Series	Martensitic SS 400 Series	Martensitic SS 400 Series
12. Nozzle Material	AISI 316	AISI 316	AISI 316	AISI 316
13. Guide Material	AISI 316	AISI 316	AISI 316	AISI 316
14. Spindle Material	Martensitic SS 400 Series	Martensitic SS 400 Series	Martensitic SS 400 Series	Martensitic SS 400 Series
15. Spring Material	UNS N07750	UNS N07750	UNS N07750	UNS N07750
16. Bellow Material	UNS N06625	UNS N06625	UNS N06625	UNS N06625
17. Valve Testing	API 527	API 527	API 527	API 527
18. Notes	Not Applicable	Not Applicable	Not Applicable	Not Applicable

Valve Code	PSV-EB-1-C11R	PSV-EB-1-C11T	PSV-EB-1-C20D	PSV-EB-1-C20E
Specs	E9 E10	E9 E10	E6 E9 E10 E19	E6 E9 E10 E19
1. Valve Type	Balanced	Balanced	Conventional	Conventional
2. Orifice Size	Orifice R (16.00 in ²)	Orifice T (26.00 in ²)	Orifice D (A=0.110 in ²)	Orifice E (0.196 in ²)
3. Valve Specification Level (VSL)	VSL-1	VSL-1	VSL-1	VSL-1
4. Standard	API 520	API 520	API 520	API 520
5. Inlet/Outlet Size Range (NPS)	6" x 10"	8" x 10"	1" x 2"	1" x 2"
6. Inlet/Outlet end connection	ASME B16.5, RF x ASME B16.5, RF	ASME B16.5, RF x ASME B16.5, RF	ASME B16.5, RF x ASME B16.5, RF	ASME B16.5, RF x ASME B16.5, RF
7. Inlet/Outlet pressure class	600 x 150	600 x 150	600 x 150	600 x 150
8. Temperature	0°C to 240°C	0°C to 240°C	-46°C to 240°C	-46°C to 240°C
9. Material Class	Carbon Steel	Carbon Steel	Carbon Steel	Carbon Steel
10. Body and bonnet Material	ASTM A216 Gr WCB	ASTM A216 Gr WCB	ASTM A352 Gr LCB	ASTM A352 Gr LCB
11. Disc Material	Martensitic SS 400 Series	Martensitic SS 400 Series	AISI 316 + Stellite	AISI 316 + Stellite
12. Nozzle Material	AISI 316	AISI 316	AISI 316	AISI 316
13. Guide Material	AISI 316	AISI 316	AISI 316	AISI 316
14. Spindle Material	Martensitic SS 400 Series	Martensitic SS 400 Series	Martensitic SS 400 Series	Martensitic SS 400 Series
15. Spring Material	UNS N07750	UNS N07750	UNS N07750	UNS N07750
16. Bellow Material	UNS N06625	UNS N06625	Not applicable	Not applicable
17. Valve Testing	API 527	API 527	API 527	API 527
18. Notes	Not Applicable	Not Applicable	Not Applicable	Not Applicable

Valve Code	PSV-EB-1-C20F	PSV-EB-1-C20G	PSV-EB-1-C20H	PSV-EB-1-C20J
Specs	E6 E9 E10 E19	E6 E9 E10 E19	E6 E9 E10 E19	E6 E9 E10 E19
1. Valve Type	Conventional	Conventional	Conventional	Conventional
2. Orifice Size	Orifice F (0.307 in ²)	Orifice G (0.503 in ²)	Orifice H (0.785 in ²)	Orifice J (1.287 in ²)
3. Valve Specification Level (VSL)	VSL-1	VSL-1	VSL-1	VSL-1
4. Standard	API 520	API 520	API 520	API 520
5. Inlet/Outlet Size Range (NPS)	1 ½" x 2"	1 ½" x 3"	2" x 3"	3" x 4"
6. Inlet/Outlet end connection	ASME B16.5, RF x ASME B16.5, RF	ASME B16.5, RF x ASME B16.5, RF	ASME B16.5, RF x ASME B16.5, RF	ASME B16.5, RF x ASME B16.5, RF
7. Inlet/Outlet pressure class	600 x 150	600 x 150	600 x 150	600 x 150
8. Temperature	-46°C to 240°C	-46°C to 240°C	-46°C to 240°C	-46°C to 240°C
9. Material Class	Carbon Steel	Carbon Steel	Carbon Steel	Carbon Steel
10. Body and bonnet Material	ASTM A352 Gr LCB	ASTM A352 Gr LCB	ASTM A352 Gr LCB	ASTM A352 Gr LCB
11. Disc Material	AISI 316 + Stellite	AISI 316 + Stellite	AISI 316 + Stellite	AISI 316 + Stellite
12. Nozzle Material	AISI 316	AISI 316	AISI 316	AISI 316
13. Guide Material	AISI 316	AISI 316	AISI 316	AISI 316
14. Spindle Material	Martensitic SS 400 Series	Martensitic SS 400 Series	Martensitic SS 400 Series	Martensitic SS 400 Series
15. Spring Material	UNS N07750	UNS N07750	UNS N07750	UNS N07750
16. Bellow Material	Not applicable	Not applicable	Not applicable	Not applicable
17. Valve Testing	API 527	API 527	API 527	API 527
18. Notes	Not Applicable	Not Applicable	Not Applicable	Not Applicable

Valve Code	PSV-EB-1-C20K	PSV-EB-1-C20L	PSV-EB-1-C20M	PSV-EB-1-C20N
Specs	E6 E9 E10 E19	E6 E9 E10 E19	E6 E9 E10 E19	E6 E9 E10 E19
1. Valve Type	Conventional	Conventional	Conventional	Conventional
2. Orifice Size	Orifice K (1.838 in ²)	Orifice L (2.853 in ²)	Orifice M (3.60 in ²)	Orifice N (4.34 in ²)
3. Valve Specification Level (VSL)	VSL-1	VSL-1	VSL-1	VSL-1
4. Standard	API 520	API 520	API 520	API 520
5. Inlet/Outlet Size Range (NPS)	3" x 4"	4" x 6"	4" x 6"	4" x 6"
6. Inlet/Outlet end connection	ASME B16.5, RF x ASME B16.5, RF	ASME B16.5, RF x ASME B16.5, RF	ASME B16.5, RF x ASME B16.5, RF	ASME B16.5, RF x ASME B16.5, RF
7. Inlet/Outlet pressure class	600 x 150	600 x 150	600 x 150	600 x 150
8. Temperature	-46°C to 240°C	-46°C to 240°C	-46°C to 240°C	-46°C to 240°C
9. Material Class	Carbon Steel	Carbon Steel	Carbon Steel	Carbon Steel
10. Body and bonnet Material	ASTM A352 Gr LCB	ASTM A352 Gr LCB	ASTM A352 Gr LCB	ASTM A352 Gr LCB
11. Disc Material	AISI 316 + Stellite	AISI 316 + Stellite	AISI 316 + Stellite	AISI 316 + Stellite
12. Nozzle Material	AISI 316	AISI 316	AISI 316	AISI 316
13. Guide Material	AISI 316	AISI 316	AISI 316	AISI 316
14. Spindle Material	Martensitic SS 400 Series	Martensitic SS 400 Series	Martensitic SS 400 Series	Martensitic SS 400 Series
15. Spring Material	UNS N07750	UNS N07750	UNS N07750	UNS N07750
16. Bellow Material	Not applicable	Not applicable	Not applicable	Not applicable
17. Valve Testing	API 527	API 527	API 527	API 527
18. Notes	Not Applicable	Not Applicable	Not Applicable	Not Applicable

Valve Code	PSV-EB-1-C20P	PSV-EB-1-C20Q	PSV-EB-1-C20R	PSV-EB-1-C20T
Specs	E6 E9 E10 E19	E6 E9 E10 E19	E6 E9 E10 E19	E6 E9 E10 E19
1. Valve Type	Conventional	Conventional	Conventional	Conventional
2. Orifice Size	Orifice P (6.38 in ²)	Orifice Q (11.05 in ²)	Orifice R (16.00 in ²)	Orifice T (26.00 in ²)
3. Valve Specification Level (VSL)	VSL-1	VSL-1	VSL-1	VSL-1
4. Standard	API 520	API 520	API 520	API 520
5. Inlet/Outlet Size Range (NPS)	4" x 6"	6" x 8"	6" x 10"	8" x 10"
6. Inlet/Outlet end connection	ASME B16.5, RF x ASME B16.5, RF	ASME B16.5, RF x ASME B16.5, RF	ASME B16.5, RF x ASME B16.5, RF	ASME B16.5, RF x ASME B16.5, RF
7. Inlet/Outlet pressure class	600 x 150	600 x 150	600 x 150	600 x 150
8. Temperature	-46°C to 240°C	-46°C to 240°C	-46°C to 240°C	-46°C to 240°C
9. Material Class	Carbon Steel	Carbon Steel	Carbon Steel	Carbon Steel
10. Body and bonnet Material	ASTM A352 Gr LCB	ASTM A352 Gr LCB	ASTM A352 Gr LCB	ASTM A352 Gr LCB
11. Disc Material	AISI 316 + Stellite	AISI 316 + Stellite	AISI 316 + Stellite	AISI 316 + Stellite
12. Nozzle Material	AISI 316	AISI 316	AISI 316	AISI 316
13. Guide Material	AISI 316	AISI 316	AISI 316	AISI 316
14. Spindle Material	Martensitic SS 400 Series	Martensitic SS 400 Series	Martensitic SS 400 Series	Martensitic SS 400 Series
15. Spring Material	UNS N07750	UNS N07750	UNS N07750	UNS N07750
16. Bellow Material	Not applicable	Not applicable	Not applicable	Not applicable
17. Valve Testing	API 527	API 527	API 527	API 527
18. Notes	Not Applicable	Not Applicable	Not Applicable	Not Applicable

Valve Code	PSV-EB-1-C21D	PSV-EB-1-C21E	PSV-EB-1-C21F	PSV-EB-1-C21G
Specs	E6 E9 E10 E19	E6 E9 E10 E19	E6 E9 E10 E19	E6 E9 E10 E19
1. Valve Type	Balanced	Balanced	Balanced	Balanced
2. Orifice Size	Orifice D (A=0.110 in ²)	Orifice E (0.196 in ²)	Orifice F (0.307 in ²)	Orifice G (0.503 in ²)
3. Valve Specification Level (VSL)	VSL-1	VSL-1	VSL-1	VSL-1
4. Standard	API 520	API 520	API 520	API 520
5. Inlet/Outlet Size Range (NPS)	1" x 2"	1" x 2"	1 ½" x 2"	1 ½" x 3"
6. Inlet/Outlet end connection	ASME B16.5, RF x ASME B16.5, RF	ASME B16.5, RF x ASME B16.5, RF	ASME B16.5, RF x ASME B16.5, RF	ASME B16.5, RF x ASME B16.5, RF
7. Inlet/Outlet pressure class	600 x 150	600 x 150	600 x 150	600 x 150
8. Temperature	-46°C to 240°C	-46°C to 240°C	-46°C to 240°C	-46°C to 240°C
9. Material Class	Carbon Steel	Carbon Steel	Carbon Steel	Carbon Steel
10. Body and bonnet Material	ASTM A352 Gr LCB	ASTM A352 Gr LCB	ASTM A352 Gr LCB	ASTM A352 Gr LCB
11. Disc Material	AISI 316 + Stellite	AISI 316 + Stellite	AISI 316 + Stellite	AISI 316 + Stellite
12. Nozzle Material	AISI 316	AISI 316	AISI 316	AISI 316
13. Guide Material	AISI 316	AISI 316	AISI 316	AISI 316
14. Spindle Material	Martensitic SS 400 Series	Martensitic SS 400 Series	Martensitic SS 400 Series	Martensitic SS 400 Series
15. Spring Material	UNS N07750	UNS N07750	UNS N07750	UNS N07750
16. Bellow Material	UNS N06625	UNS N06625	UNS N06625	UNS N06625
17. Valve Testing	API 527	API 527	API 527	API 527
18. Notes	Not Applicable	Not Applicable	Not Applicable	Not Applicable

Valve Code	PSV-EB-1-C21H	PSV-EB-1-C21J	PSV-EB-1-C21K	PSV-EB-1-C21L
Specs	E6 E9 E10 E19	E6 E9 E10 E19	E6 E9 E10 E19	E6 E9 E10 E19
1. Valve Type	Balanced	Balanced	Balanced	Balanced
2. Orifice Size	Orifice H (0.785 in ²)	Orifice J (1.287 in ²)	Orifice K (1.838 in ²)	Orifice L (2.853 in ²)
3. Valve Specification Level (VSL)	VSL-1	VSL-1	VSL-1	VSL-1
4. Standard	API 520	API 520	API 520	API 520
5. Inlet/Outlet Size Range (NPS)	2" x 3"	3" x 4"	3" x 4"	4" x 6"
6. Inlet/Outlet end connection	ASME B16.5, RF x ASME B16.5, RF	ASME B16.5, RF x ASME B16.5, RF	ASME B16.5, RF x ASME B16.5, RF	ASME B16.5, RF x ASME B16.5, RF
7. Inlet/Outlet pressure class	600 x 150	600 x 150	600 x 150	600 x 150
8. Temperature	-46°C to 240°C	-46°C to 240°C	-46°C to 240°C	-46°C to 240°C
9. Material Class	Carbon Steel	Carbon Steel	Carbon Steel	Carbon Steel
10. Body and bonnet Material	ASTM A352 Gr LCB	ASTM A352 Gr LCB	ASTM A352 Gr LCB	ASTM A352 Gr LCB
11. Disc Material	AISI 316 + Stellite	AISI 316 + Stellite	AISI 316 + Stellite	AISI 316 + Stellite
12. Nozzle Material	AISI 316	AISI 316	AISI 316	AISI 316
13. Guide Material	AISI 316	AISI 316	AISI 316	AISI 316
14. Spindle Material	Martensitic SS 400 Series	Martensitic SS 400 Series	Martensitic SS 400 Series	Martensitic SS 400 Series
15. Spring Material	UNS N07750	UNS N07750	UNS N07750	UNS N07750
16. Bellow Material	UNS N06625	UNS N06625	UNS N06625	UNS N06625
17. Valve Testing	API 527	API 527	API 527	API 527
18. Notes	Not Applicable	Not Applicable	Not Applicable	Not Applicable

Valve Code	PSV-EB-1-C21M	PSV-EB-1-C21N	PSV-EB-1-C21P	PSV-EB-1-C21Q
Specs	E6 E9 E10 E19	E6 E9 E10 E19	E6 E9 E10 E19	E6 E9 E10 E19
1. Valve Type	Balanced	Balanced	Balanced	Balanced
2. Orifice Size	Orifice M (3.60 in ²)	Orifice N (4.34 in ²)	Orifice P (6.38 in ²)	Orifice Q (11.05 in ²)
3. Valve Specification Level (VSL)	VSL-1	VSL-1	VSL-1	VSL-1
4. Standard	API 520	API 520	API 520	API 520
5. Inlet/Outlet Size Range (NPS)	4" x 6"	4" x 6"	4" x 6"	6" x 8"
6. Inlet/Outlet end connection	ASME B16.5, RF x ASME B16.5, RF	ASME B16.5, RF x ASME B16.5, RF	ASME B16.5, RF x ASME B16.5, RF	ASME B16.5, RF x ASME B16.5, RF
7. Inlet/Outlet pressure class	600 x 150	600 x 150	600 x 150	600 x 150
8. Temperature	-46°C to 240°C	-46°C to 240°C	-46°C to 240°C	-46°C to 240°C
9. Material Class	Carbon Steel	Carbon Steel	Carbon Steel	Carbon Steel
10. Body and bonnet Material	ASTM A352 Gr LCB	ASTM A352 Gr LCB	ASTM A352 Gr LCB	ASTM A352 Gr LCB
11. Disc Material	AISI 316 + Stellite	AISI 316 + Stellite	AISI 316 + Stellite	AISI 316 + Stellite
12. Nozzle Material	AISI 316	AISI 316	AISI 316	AISI 316
13. Guide Material	AISI 316	AISI 316	AISI 316	AISI 316
14. Spindle Material	Martensitic SS 400 Series	Martensitic SS 400 Series	Martensitic SS 400 Series	Martensitic SS 400 Series
15. Spring Material	UNS N07750	UNS N07750	UNS N07750	UNS N07750
16. Bellow Material	UNS N06625	UNS N06625	UNS N06625	UNS N06625
17. Valve Testing	API 527	API 527	API 527	API 527
18. Notes	Not Applicable	Not Applicable	Not Applicable	Not Applicable

Valve Code	PSV-EB-1-C21R	PSV-EB-1-C21T	PSV-EB-1-D21D	PSV-EB-1-D21E
Specs	E6 E9 E10 E19	E6 E9 E10 E19	E16	E16
1. Valve Type	Balanced	Balanced	Balanced	Balanced
2. Orifice Size	Orifice R (16.00 in ²)	Orifice T (26.00 in ²)	Orifice D (A=0.110 in ²)	Orifice E (0.196 in ²)
3. Valve Specification Level (VSL)	VSL-1	VSL-1	VSL-1	VSL-1
4. Standard	API 520	API 520	API 520	API 520
5. Inlet/Outlet Size Range (NPS)	6" x 10"	8" x 10"	1" x 2"	1" x 2"
6. Inlet/Outlet end connection	ASME B16.5, RF x ASME B16.5, RF	ASME B16.5, RF x ASME B16.5, RF	ASME B16.5, RF x ASME B16.5, RF	ASME B16.5, RF x ASME B16.5, RF
7. Inlet/Outlet pressure class	600 x 150	600 x 150	600 x 150	600 x 150
8. Temperature	-46°C to 240°C	-46°C to 240°C	-50°C to 100°C	-50°C to 100°C
9. Material Class	Carbon Steel	Carbon Steel	Duplex Steel	Duplex Steel
10. Body and bonnet Material	ASTM A352 Gr LCB	ASTM A352 Gr LCB	ASTM A995 Gr 4a	ASTM A995 Gr 4a
11. Disc Material	AISI 316 + Stellite	AISI 316 + Stellite	ASTM A479 (UNS S31803)	ASTM A479 (UNS S31803)
12. Nozzle Material	AISI 316	AISI 316	ASTM A479 (UNS S31803)	ASTM A479 (UNS S31803)
13. Guide Material	AISI 316	AISI 316	AISI 316	AISI 316
14. Spindle Material	Martensitic SS 400 Series	Martensitic SS 400 Series	Martensitic SS 400 Series	Martensitic SS 400 Series
15. Spring Material	UNS N07750	UNS N07750	UNS N07750	UNS N07750
16. Bellow Material	UNS N06625	UNS N06625	UNS N06625	UNS N06625
17. Valve Testing	API 527	API 527	API 527	API 527
18. Notes	Not Applicable	Not Applicable	Not Applicable	Not Applicable

Valve Code	PSV-EB-1-D21F	PSV-EB-1-D21G	PSV-EB-1-D21H	PSV-EB-1-D21J
Specs	E16	E16	E16	E16
1. Valve Type	Balanced	Balanced	Balanced	Balanced
2. Orifice Size	Orifice F (0.307 in ²)	Orifice G (0.503 in ²)	Orifice H (0.785 in ²)	Orifice J (1.287 in ²)
3. Valve Specification Level (VSL)	VSL-1	VSL-1	VSL-1	VSL-1
4. Standard	API 520	API 520	API 520	API 520
5. Inlet/Outlet Size Range (NPS)	1 ½" x 2"	1 ½" x 3"	2" x 3"	3" x 4"
6. Inlet/Outlet end connection	ASME B16.5, RF x ASME B16.5, RF	ASME B16.5, RF x ASME B16.5, RF	ASME B16.5, RF x ASME B16.5, RF	ASME B16.5, RF x ASME B16.5, RF
7. Inlet/Outlet pressure class	600 x 150	600 x 150	600 x 150	600 x 150
8. Temperature	-50°C to 100°C	-50°C to 100°C	-50°C to 100°C	-50°C to 100°C
9. Material Class	Duplex Steel	Duplex Steel	Duplex Steel	Duplex Steel
10. Body and bonnet Material	ASTM A995 Gr 4a	ASTM A995 Gr 4a	ASTM A995 Gr 4a	ASTM A995 Gr 4a
11. Disc Material	ASTM A479 (UNS S31803)	ASTM A479 (UNS S31803)	ASTM A479 (UNS S31803)	ASTM A479 (UNS S31803)
12. Nozzle Material	ASTM A479 (UNS S31803)	ASTM A479 (UNS S31803)	ASTM A479 (UNS S31803)	ASTM A479 (UNS S31803)
13. Guide Material	AISI 316	AISI 316	AISI 316	AISI 316
14. Spindle Material	Martensitic SS 400 Series	Martensitic SS 400 Series	Martensitic SS 400 Series	Martensitic SS 400 Series
15. Spring Material	UNS N07750	UNS N07750	UNS N07750	UNS N07750
16. Bellow Material	UNS N06625	UNS N06625	UNS N06625	UNS N06625
17. Valve Testing	API 527	API 527	API 527	API 527
18. Notes	Not Applicable	Not Applicable	Not Applicable	Not Applicable

Valve Code	PSV-EB-1-D21K	PSV-EB-1-D21L	PSV-EB-1-D21M	PSV-EB-1-D21N
Specs	E16	E16	E16	E16
1. Valve Type	Balanced	Balanced	Balanced	Balanced
2. Orifice Size	Orifice K (1.838 in ²)	Orifice L (2.853 in ²)	Orifice M (3.60 in ²)	Orifice N (4.34 in ²)
3. Valve Specification Level (VSL)	VSL-1	VSL-1	VSL-1	VSL-1
4. Standard	API 520	API 520	API 520	API 520
5. Inlet/Outlet Size Range (NPS)	3" x 4"	4" x 6"	4" x 6"	4" x 6"
6. Inlet/Outlet end connection	ASME B16.5, RF x ASME B16.5, RF	ASME B16.5, RF x ASME B16.5, RF	ASME B16.5, RF x ASME B16.5, RF	ASME B16.5, RF x ASME B16.5, RF
7. Inlet/Outlet pressure class	600 x 150	600 x 150	600 x 150	600 x 150
8. Temperature	-50°C to 100°C	-50°C to 100°C	-50°C to 100°C	-50°C to 100°C
9. Material Class	Duplex Steel	Duplex Steel	Duplex Steel	Duplex Steel
10. Body and bonnet Material	ASTM A995 Gr 4a	ASTM A995 Gr 4a	ASTM A995 Gr 4a	ASTM A995 Gr 4a
11. Disc Material	ASTM A479 (UNS S31803)	ASTM A479 (UNS S31803)	ASTM A479 (UNS S31803)	ASTM A479 (UNS S31803)
12. Nozzle Material	ASTM A479 (UNS S31803)	ASTM A479 (UNS S31803)	ASTM A479 (UNS S31803)	ASTM A479 (UNS S31803)
13. Guide Material	AISI 316	AISI 316	AISI 316	AISI 316
14. Spindle Material	Martensitic SS 400 Series	Martensitic SS 400 Series	Martensitic SS 400 Series	Martensitic SS 400 Series
15. Spring Material	UNS N07750	UNS N07750	UNS N07750	UNS N07750
16. Bellow Material	UNS N06625	UNS N06625	UNS N06625	UNS N06625
17. Valve Testing	API 527	API 527	API 527	API 527
18. Notes	Not Applicable	Not Applicable	Not Applicable	Not Applicable

Valve Code	PSV-EB-1-D21P	PSV-EB-1-D21Q	PSV-EB-1-D21R	PSV-EB-1-D21T
Specs	E16	E16	E16	E16
1. Valve Type	Balanced	Balanced	Balanced	Balanced
2. Orifice Size	Orifice P (6.38 in ²)	Orifice Q (11.05 in ²)	Orifice R (16.00 in ²)	Orifice T (26.00 in ²)
3. Valve Specification Level (VSL)	VSL-1	VSL-1	VSL-1	VSL-1
4. Standard	API 520	API 520	API 520	API 520
5. Inlet/Outlet Size Range (NPS)	4" x 6"	6" x 8"	6" x 10"	8" x 10"
6. Inlet/Outlet end connection	ASME B16.5, RF x ASME B16.5, RF	ASME B16.5, RF x ASME B16.5, RF	ASME B16.5, RF x ASME B16.5, RF	ASME B16.5, RF x ASME B16.5, RF
7. Inlet/Outlet pressure class	600 x 150	600 x 150	600 x 150	600 x 150
8. Temperature	-50°C to 100°C	-50°C to 100°C	-50°C to 100°C	-50°C to 100°C
9. Material Class	Duplex Steel	Duplex Steel	Duplex Steel	Duplex Steel
10. Body and bonnet Material	ASTM A995 Gr 4a	ASTM A995 Gr 4a	ASTM A995 Gr 4a	ASTM A995 Gr 4a
11. Disc Material	ASTM A479 (UNS S31803)	ASTM A479 (UNS S31803)	ASTM A479 (UNS S31803)	ASTM A479 (UNS S31803)
12. Nozzle Material	ASTM A479 (UNS S31803)	ASTM A479 (UNS S31803)	ASTM A479 (UNS S31803)	ASTM A479 (UNS S31803)
13. Guide Material	AISI 316	AISI 316	AISI 316	AISI 316
14. Spindle Material	Martensitic SS 400 Series	Martensitic SS 400 Series	Martensitic SS 400 Series	Martensitic SS 400 Series
15. Spring Material	UNS N07750	UNS N07750	UNS N07750	UNS N07750
16. Bellow Material	UNS N06625	UNS N06625	UNS N06625	UNS N06625
17. Valve Testing	API 527	API 527	API 527	API 527
18. Notes	Not Applicable	Not Applicable	Not Applicable	Not Applicable

Valve Code	PSV-EB-1-N11D	PSV-EB-1-N11E	PSV-EB-1-N11F	PSV-EB-1-N11G
Specs	E30	E30	E30	E30
1. Valve Type	Balanced	Balanced	Balanced	Balanced
2. Orifice Size	Orifice D (A=0.110 in ²)	Orifice E (0.196 in ²)	Orifice F (0.307 in ²)	Orifice G (0.503 in ²)
3. Valve Specification Level (VSL)	VSL-1	VSL-1	VSL-1	VSL-1
4. Standard	API 520	API 520	API 520	API 520
5. Inlet/Outlet Size Range (NPS)	1" x 2"	1" x 2"	1 ½" x 2"	1 ½" x 3"
6. Inlet/Outlet end connection	ASME B16.5, RF x ASME B16.5, RF	ASME B16.5, RF x ASME B16.5, RF	ASME B16.5, RF x ASME B16.5, RF	ASME B16.5, RF x ASME B16.5, RF
7. Inlet/Outlet pressure class	600 x 150	600 x 150	600 x 150	600 x 150
8. Temperature	-100°C to 155°C	-100°C to 155°C	-100°C to 155°C	-100°C to 155°C
9. Material Class	Nickel Alloys	Nickel Alloys	Nickel Alloys	Nickel Alloys
10. Body and bonnet Material	UNS N06625	UNS N06625	UNS N06625	UNS N06625
11. Disc Material	UNS N06625	UNS N06625	UNS N06625	UNS N06625
12. Nozzle Material	ASTM B564 (UNS N06625)	ASTM B564 (UNS N06625)	ASTM B564 (UNS N06625)	ASTM B564 (UNS N06625)
13. Guide Material	AISI 316	AISI 316	AISI 316	AISI 316
14. Spindle Material	Martensitic SS 400 Series	Martensitic SS 400 Series	Martensitic SS 400 Series	Martensitic SS 400 Series
15. Spring Material	UNS N07750	UNS N07750	UNS N07750	UNS N07750
16. Bellow Material	UNS N06625	UNS N06625	UNS N06625	UNS N06625
17. Valve Testing	API 527	API 527	API 527	API 527
18. Notes	Not Applicable	Not Applicable	Not Applicable	Not Applicable

Valve Code	PSV-EB-1-N11H	PSV-EB-1-N11J	PSV-EB-1-N11K	PSV-EB-1-N11L
Specs	E30	E30	E30	E30
1. Valve Type	Balanced	Balanced	Balanced	Balanced
2. Orifice Size	Orifice H (0.785 in ²)	Orifice J (1.287 in ²)	Orifice K (1.838 in ²)	Orifice L (2.853 in ²)
3. Valve Specification Level (VSL)	VSL-1	VSL-1	VSL-1	VSL-1
4. Standard	API 520	API 520	API 520	API 520
5. Inlet/Outlet Size Range (NPS)	2" x 3"	3" x 4"	3" x 4"	4" x 6"
6. Inlet/Outlet end connection	ASME B16.5, RF x ASME B16.5, RF	ASME B16.5, RF x ASME B16.5, RF	ASME B16.5, RF x ASME B16.5, RF	ASME B16.5, RF x ASME B16.5, RF
7. Inlet/Outlet pressure class	600 x 150	600 x 150	600 x 150	600 x 150
8. Temperature	-100°C to 155°C	-100°C to 155°C	-100°C to 155°C	-100°C to 155°C
9. Material Class	Nickel Alloys	Nickel Alloys	Nickel Alloys	Nickel Alloys
10. Body and bonnet Material	UNS N06625	UNS N06625	UNS N06625	UNS N06625
11. Disc Material	UNS N06625	UNS N06625	UNS N06625	UNS N06625
12. Nozzle Material	ASTM B564 (UNS N06625)	ASTM B564 (UNS N06625)	ASTM B564 (UNS N06625)	ASTM B564 (UNS N06625)
13. Guide Material	AISI 316	AISI 316	AISI 316	AISI 316
14. Spindle Material	Martensitic SS 400 Series	Martensitic SS 400 Series	Martensitic SS 400 Series	Martensitic SS 400 Series
15. Spring Material	UNS N07750	UNS N07750	UNS N07750	UNS N07750
16. Bellow Material	UNS N06625	UNS N06625	UNS N06625	UNS N06625
17. Valve Testing	API 527	API 527	API 527	API 527
18. Notes	Not Applicable	Not Applicable	Not Applicable	Not Applicable

Valve Code	PSV-EB-1-N11M	PSV-EB-1-N11N	PSV-EB-1-N11P	PSV-EB-1-N11Q
Specs	E30	E30	E30	E30
1. Valve Type	Balanced	Balanced	Balanced	Balanced
2. Orifice Size	Orifice M (3.60 in ²)	Orifice N (4.34 in ²)	Orifice P (6.38 in ²)	Orifice Q (11.05 in ²)
3. Valve Specification Level (VSL)	VSL-1	VSL-1	VSL-1	VSL-1
4. Standard	API 520	API 520	API 520	API 520
5. Inlet/Outlet Size Range (NPS)	4" x 6"	4" x 6"	4" x 6"	6" x 8"
6. Inlet/Outlet end connection	ASME B16.5, RF x ASME B16.5, RF	ASME B16.5, RF x ASME B16.5, RF	ASME B16.5, RF x ASME B16.5, RF	ASME B16.5, RF x ASME B16.5, RF
7. Inlet/Outlet pressure class	600 x 150	600 x 150	600 x 150	600 x 150
8. Temperature	-100°C to 155°C	-100°C to 155°C	-100°C to 155°C	-100°C to 155°C
9. Material Class	Nickel Alloys	Nickel Alloys	Nickel Alloys	Nickel Alloys
10. Body and bonnet Material	UNS N06625	UNS N06625	UNS N06625	UNS N06625
11. Disc Material	UNS N06625	UNS N06625	UNS N06625	UNS N06625
12. Nozzle Material	ASTM B564 (UNS N06625)	ASTM B564 (UNS N06625)	ASTM B564 (UNS N06625)	ASTM B564 (UNS N06625)
13. Guide Material	AISI 316	AISI 316	AISI 316	AISI 316
14. Spindle Material	Martensitic SS 400 Series	Martensitic SS 400 Series	Martensitic SS 400 Series	Martensitic SS 400 Series
15. Spring Material	UNS N07750	UNS N07750	UNS N07750	UNS N07750
16. Bellow Material	UNS N06625	UNS N06625	UNS N06625	UNS N06625
17. Valve Testing	API 527	API 527	API 527	API 527
18. Notes	Not Applicable	Not Applicable	Not Applicable	Not Applicable

Valve Code	PSV-EB-1-N11R	PSV-EB-1-N11T	PSV-EB-1-S21D	PSV-EB-1-S21E
Specs	E30	E30	E3 E6 E9 E10 E19	E3 E6 E9 E10 E19
1. Valve Type	Balanced	Balanced	Balanced	Balanced
2. Orifice Size	Orifice R (16.00 in ²)	Orifice T (26.00 in ²)	Orifice D (A=0.110 in ²)	Orifice E (0.196 in ²)
3. Valve Specification Level (VSL)	VSL-1	VSL-1	VSL-1	VSL-1
4. Standard	API 520	API 520	API 520	API 520
5. Inlet/Outlet Size Range (NPS)	6" x 10"	8" x 10"	1" x 2"	1" x 2"
6. Inlet/Outlet end connection	ASME B16.5, RF x ASME B16.5, RF	ASME B16.5, RF x ASME B16.5, RF	ASME B16.5, RF x ASME B16.5, RF	ASME B16.5, RF x ASME B16.5, RF
7. Inlet/Outlet pressure class	600 x 150	600 x 150	600 x 150	600 x 150
8. Temperature	-100°C to 155°C	-100°C to 155°C	-100°C to 260°C	-100°C to 260°C
9. Material Class	Nickel Alloys	Nickel Alloys	Stainless Steel	Stainless Steel
10. Body and bonnet Material	UNS N06625	UNS N06625	ASTM A182 Gr CF8M	ASTM A182 Gr CF8M
11. Disc Material	UNS N06625	UNS N06625	AISI 316 + Stellite	AISI 316 + Stellite
12. Nozzle Material	ASTM B564 (UNS N06625)	ASTM B564 (UNS N06625)	AISI 316	AISI 316
13. Guide Material	AISI 316	AISI 316	AISI 316	AISI 316
14. Spindle Material	Martensitic SS 400 Series	Martensitic SS 400 Series	Martensitic SS 400 Series	Martensitic SS 400 Series
15. Spring Material	UNS N07750	UNS N07750	UNS N07750	UNS N07750
16. Bellow Material	UNS N06625	UNS N06625	UNS N06625	UNS N06625
17. Valve Testing	API 527	API 527	API 527	API 527
18. Notes	Not Applicable	Not Applicable	Not Applicable	Not Applicable

Valve Code	PSV-EB-1-S21F	PSV-EB-1-S21G	PSV-EB-1-S21H	PSV-EB-1-S21J
Specs	E3 E6 E9 E10 E19	E3 E6 E9 E10 E19	E3 E6 E9 E10 E19	E3 E6 E9 E10 E19
1. Valve Type	Balanced	Balanced	Balanced	Balanced
2. Orifice Size	Orifice F (0.307 in ²)	Orifice G (0.503 in ²)	Orifice H (0.785 in ²)	Orifice J (1.287 in ²)
3. Valve Specification Level (VSL)	VSL-1	VSL-1	VSL-1	VSL-1
4. Standard	API 520	API 520	API 520	API 520
5. Inlet/Outlet Size Range (NPS)	1 ½" x 2"	1 ½" x 3"	2" x 3"	3" x 4"
6. Inlet/Outlet end connection	ASME B16.5, RF x ASME B16.5, RF	ASME B16.5, RF x ASME B16.5, RF	ASME B16.5, RF x ASME B16.5, RF	ASME B16.5, RF x ASME B16.5, RF
7. Inlet/Outlet pressure class	600 x 150	600 x 150	600 x 150	600 x 150
8. Temperature	-100°C to 260°C	-100°C to 260°C	-100°C to 260°C	-100°C to 260°C
9. Material Class	Stainless Steel	Stainless Steel	Stainless Steel	Stainless Steel
10. Body and bonnet Material	ASTM A182 Gr CF8M	ASTM A182 Gr CF8M	ASTM A182 Gr CF8M	ASTM A182 Gr CF8M
11. Disc Material	AISI 316 + Stellite	AISI 316 + Stellite	AISI 316 + Stellite	AISI 316 + Stellite
12. Nozzle Material	AISI 316	AISI 316	AISI 316	AISI 316
13. Guide Material	AISI 316	AISI 316	AISI 316	AISI 316
14. Spindle Material	Martensitic SS 400 Series	Martensitic SS 400 Series	Martensitic SS 400 Series	Martensitic SS 400 Series
15. Spring Material	UNS N07750	UNS N07750	UNS N07750	UNS N07750
16. Bellow Material	UNS N06625	UNS N06625	UNS N06625	UNS N06625
17. Valve Testing	API 527	API 527	API 527	API 527
18. Notes	Not Applicable	Not Applicable	Not Applicable	Not Applicable

Valve Code	PSV-EB-1-S21K	PSV-EB-1-S21L	PSV-EB-1-S21M	PSV-EB-1-S21N
Specs	E3 E6 E9 E10 E19	E3 E6 E9 E10 E19	E3 E6 E9 E10 E19	E3 E6 E9 E10 E19
1. Valve Type	Balanced	Balanced	Balanced	Balanced
2. Orifice Size	Orifice K (1.838 in ²)	Orifice L (2.853 in ²)	Orifice M (3.60 in ²)	Orifice N (4.34 in ²)
3. Valve Specification Level (VSL)	VSL-1	VSL-1	VSL-1	VSL-1
4. Standard	API 520	API 520	API 520	API 520
5. Inlet/Outlet Size Range (NPS)	3" x 4"	4" x 6"	4" x 6"	4" x 6"
6. Inlet/Outlet end connection	ASME B16.5, RF x ASME B16.5, RF	ASME B16.5, RF x ASME B16.5, RF	ASME B16.5, RF x ASME B16.5, RF	ASME B16.5, RF x ASME B16.5, RF
7. Inlet/Outlet pressure class	600 x 150	600 x 150	600 x 150	600 x 150
8. Temperature	-100°C to 260°C	-100°C to 260°C	-100°C to 260°C	-100°C to 260°C
9. Material Class	Stainless Steel	Stainless Steel	Stainless Steel	Stainless Steel
10. Body and bonnet Material	ASTM A182 Gr CF8M	ASTM A182 Gr CF8M	ASTM A182 Gr CF8M	ASTM A182 Gr CF8M
11. Disc Material	AISI 316 + Stellite	AISI 316 + Stellite	AISI 316 + Stellite	AISI 316 + Stellite
12. Nozzle Material	AISI 316	AISI 316	AISI 316	AISI 316
13. Guide Material	AISI 316	AISI 316	AISI 316	AISI 316
14. Spindle Material	Martensitic SS 400 Series	Martensitic SS 400 Series	Martensitic SS 400 Series	Martensitic SS 400 Series
15. Spring Material	UNS N07750	UNS N07750	UNS N07750	UNS N07750
16. Bellow Material	UNS N06625	UNS N06625	UNS N06625	UNS N06625
17. Valve Testing	API 527	API 527	API 527	API 527
18. Notes	Not Applicable	Not Applicable	Not Applicable	Not Applicable

Valve Code	PSV-EB-1-S21P	PSV-EB-1-S21Q	PSV-EB-1-S21R	PSV-EB-1-S21T
Specs	E3 E6 E9 E10 E19	E3 E6 E9 E10 E19	E3 E6 E9 E10 E19	E3 E6 E9 E10 E19
1. Valve Type	Balanced	Balanced	Balanced	Balanced
2. Orifice Size	Orifice P (6.38 in ²)	Orifice Q (11.05 in ²)	Orifice R (16.00 in ²)	Orifice T (26.00 in ²)
3. Valve Specification Level (VSL)	VSL-1	VSL-1	VSL-1	VSL-1
4. Standard	API 520	API 520	API 520	API 520
5. Inlet/Outlet Size Range (NPS)	4" x 6"	6" x 8"	6" x 10"	8" x 10"
6. Inlet/Outlet end connection	ASME B16.5, RF x ASME B16.5, RF	ASME B16.5, RF x ASME B16.5, RF	ASME B16.5, RF x ASME B16.5, RF	ASME B16.5, RF x ASME B16.5, RF
7. Inlet/Outlet pressure class	600 x 150	600 x 150	600 x 150	600 x 150
8. Temperature	-100°C to 260°C	-100°C to 260°C	-100°C to 260°C	-100°C to 260°C
9. Material Class	Stainless Steel	Stainless Steel	Stainless Steel	Stainless Steel
10. Body and bonnet Material	ASTM A182 Gr CF8M	ASTM A182 Gr CF8M	ASTM A182 Gr CF8M	ASTM A182 Gr CF8M
11. Disc Material	AISI 316 + Stellite	AISI 316 + Stellite	AISI 316 + Stellite	AISI 316 + Stellite
12. Nozzle Material	AISI 316	AISI 316	AISI 316	AISI 316
13. Guide Material	AISI 316	AISI 316	AISI 316	AISI 316
14. Spindle Material	Martensitic SS 400 Series	Martensitic SS 400 Series	Martensitic SS 400 Series	Martensitic SS 400 Series
15. Spring Material	UNS N07750	UNS N07750	UNS N07750	UNS N07750
16. Bellow Material	UNS N06625	UNS N06625	UNS N06625	UNS N06625
17. Valve Testing	API 527	API 527	API 527	API 527
18. Notes	Not Applicable	Not Applicable	Not Applicable	Not Applicable

Valve Code	PSV-EB-2-C10D	PSV-EB-2-C10E	PSV-EB-2-C10F	PSV-EB-2-C10G
Specs	E9 E10	E9 E10	E9 E10	E9 E10
1. Valve Type	Conventional	Conventional	Conventional	Conventional
2. Orifice Size	Orifice D (A=0.110 in ²)	Orifice E (0.196 in ²)	Orifice F (0.307 in ²)	Orifice G (0.503 in ²)
3. Valve Specification Level (VSL)	VSL-2	VSL-2	VSL-2	VSL-2
4. Standard	API 520	API 520	API 520	API 520
5. Inlet/Outlet Size Range (NPS)	1" x 2"	1" x 2"	1 ½" x 2"	1 ½" x 3"
6. Inlet/Outlet end connection	ASME B16.5, RF x ASME B16.5, RF	ASME B16.5, RF x ASME B16.5, RF	ASME B16.5, RF x ASME B16.5, RF	ASME B16.5, RF x ASME B16.5, RF
7. Inlet/Outlet pressure class	600 x 150	600 x 150	600 x 150	600 x 150
8. Temperature	0°C to 240°C	0°C to 240°C	0°C to 240°C	0°C to 240°C
9. Material Class	Carbon Steel	Carbon Steel	Carbon Steel	Carbon Steel
10. Body and bonnet Material	ASTM A216 Gr WCB	ASTM A216 Gr WCB	ASTM A216 Gr WCB	ASTM A216 Gr WCB
11. Disc Material	Martensitic SS 400 Series	Martensitic SS 400 Series	Martensitic SS 400 Series	Martensitic SS 400 Series
12. Nozzle Material	AISI 316	AISI 316	AISI 316	AISI 316
13. Guide Material	AISI 316	AISI 316	AISI 316	AISI 316
14. Spindle Material	Martensitic SS 400 Series	Martensitic SS 400 Series	Martensitic SS 400 Series	Martensitic SS 400 Series
15. Spring Material	UNS N07750	UNS N07750	UNS N07750	UNS N07750
16. Bellow Material	Not applicable	Not applicable	Not applicable	Not applicable
17. Valve Testing	API 527	API 527	API 527	API 527
18. Notes	Not Applicable	Not Applicable	Not Applicable	Not Applicable

Valve Code	PSV-EB-2-C10H	PSV-EB-2-C10J	PSV-EB-2-C10K	PSV-EB-2-C10L
Specs	E9 E10	E9 E10	E9 E10	E9 E10
1. Valve Type	Conventional	Conventional	Conventional	Conventional
2. Orifice Size	Orifice H (0.785 in ²)	Orifice J (1.287 in ²)	Orifice K (1.838 in ²)	Orifice L (2.853 in ²)
3. Valve Specification Level (VSL)	VSL-2	VSL-2	VSL-2	VSL-2
4. Standard	API 520	API 520	API 520	API 520
5. Inlet/Outlet Size Range (NPS)	2" x 3"	3" x 4"	3" x 4"	4" x 6"
6. Inlet/Outlet end connection	ASME B16.5, RF x ASME B16.5, RF	ASME B16.5, RF x ASME B16.5, RF	ASME B16.5, RF x ASME B16.5, RF	ASME B16.5, RF x ASME B16.5, RF
7. Inlet/Outlet pressure class	600 x 150	600 x 150	600 x 150	600 x 150
8. Temperature	0°C to 240°C	0°C to 240°C	0°C to 240°C	0°C to 240°C
9. Material Class	Carbon Steel	Carbon Steel	Carbon Steel	Carbon Steel
10. Body and bonnet Material	ASTM A216 Gr WCB	ASTM A216 Gr WCB	ASTM A216 Gr WCB	ASTM A216 Gr WCB
11. Disc Material	Martensitic SS 400 Series	Martensitic SS 400 Series	Martensitic SS 400 Series	Martensitic SS 400 Series
12. Nozzle Material	AISI 316	AISI 316	AISI 316	AISI 316
13. Guide Material	AISI 316	AISI 316	AISI 316	AISI 316
14. Spindle Material	Martensitic SS 400 Series	Martensitic SS 400 Series	Martensitic SS 400 Series	Martensitic SS 400 Series
15. Spring Material	UNS N07750	UNS N07750	UNS N07750	UNS N07750
16. Bellow Material	Not applicable	Not applicable	Not applicable	Not applicable
17. Valve Testing	API 527	API 527	API 527	API 527
18. Notes	Not Applicable	Not Applicable	Not Applicable	Not Applicable

Valve Code	PSV-EB-2-C10M	PSV-EB-2-C10N	PSV-EB-2-C10P	PSV-EB-2-C10Q
Specs	E9 E10	E9 E10	E9 E10	E9 E10
1. Valve Type	Conventional	Conventional	Conventional	Conventional
2. Orifice Size	Orifice M (3.60 in ²)	Orifice N (4.34 in ²)	Orifice P (6.38 in ²)	Orifice Q (11.05 in ²)
3. Valve Specification Level (VSL)	VSL-2	VSL-2	VSL-2	VSL-2
4. Standard	API 520	API 520	API 520	API 520
5. Inlet/Outlet Size Range (NPS)	4" x 6"	4" x 6"	4" x 6"	6" x 8"
6. Inlet/Outlet end connection	ASME B16.5, RF x ASME B16.5, RF	ASME B16.5, RF x ASME B16.5, RF	ASME B16.5, RF x ASME B16.5, RF	ASME B16.5, RF x ASME B16.5, RF
7. Inlet/Outlet pressure class	600 x 150	600 x 150	600 x 150	600 x 150
8. Temperature	0°C to 240°C	0°C to 240°C	0°C to 240°C	0°C to 240°C
9. Material Class	Carbon Steel	Carbon Steel	Carbon Steel	Carbon Steel
10. Body and bonnet Material	ASTM A216 Gr WCB	ASTM A216 Gr WCB	ASTM A216 Gr WCB	ASTM A216 Gr WCB
11. Disc Material	Martensitic SS 400 Series	Martensitic SS 400 Series	Martensitic SS 400 Series	Martensitic SS 400 Series
12. Nozzle Material	AISI 316	AISI 316	AISI 316	AISI 316
13. Guide Material	AISI 316	AISI 316	AISI 316	AISI 316
14. Spindle Material	Martensitic SS 400 Series	Martensitic SS 400 Series	Martensitic SS 400 Series	Martensitic SS 400 Series
15. Spring Material	UNS N07750	UNS N07750	UNS N07750	UNS N07750
16. Bellow Material	Not applicable	Not applicable	Not applicable	Not applicable
17. Valve Testing	API 527	API 527	API 527	API 527
18. Notes	Not Applicable	Not Applicable	Not Applicable	Not Applicable

Valve Code	PSV-EB-2-C10R	PSV-EB-2-C10T	PSV-EB-2-C11D	PSV-EB-2-C11E
Specs	E9 E10	E9 E10	E9 E10	E9 E10
1. Valve Type	Conventional	Conventional	Balanced	Balanced
2. Orifice Size	Orifice R (16.00 in ²)	Orifice T (26.00 in ²)	Orifice D (A=0.110 in ²)	Orifice E (0.196 in ²)
3. Valve Specification Level (VSL)	VSL-2	VSL-2	VSL-2	VSL-2
4. Standard	API 520	API 520	API 520	API 520
5. Inlet/Outlet Size Range (NPS)	6" x 10"	8" x 10"	1" x 2"	1" x 2"
6. Inlet/Outlet end connection	ASME B16.5, RF x ASME B16.5, RF	ASME B16.5, RF x ASME B16.5, RF	ASME B16.5, RF x ASME B16.5, RF	ASME B16.5, RF x ASME B16.5, RF
7. Inlet/Outlet pressure class	600 x 150	600 x 150	600 x 150	600 x 150
8. Temperature	0°C to 240°C	0°C to 240°C	0°C to 240°C	0°C to 240°C
9. Material Class	Carbon Steel	Carbon Steel	Carbon Steel	Carbon Steel
10. Body and bonnet Material	ASTM A216 Gr WCB	ASTM A216 Gr WCB	ASTM A216 Gr WCB	ASTM A216 Gr WCB
11. Disc Material	Martensitic SS 400 Series	Martensitic SS 400 Series	Martensitic SS 400 Series	Martensitic SS 400 Series
12. Nozzle Material	AISI 316	AISI 316	AISI 316	AISI 316
13. Guide Material	AISI 316	AISI 316	AISI 316	AISI 316
14. Spindle Material	Martensitic SS 400 Series	Martensitic SS 400 Series	Martensitic SS 400 Series	Martensitic SS 400 Series
15. Spring Material	UNS N07750	UNS N07750	UNS N07750	UNS N07750
16. Bellow Material	Not applicable	Not applicable	UNS N06625	UNS N06625
17. Valve Testing	API 527	API 527	API 527	API 527
18. Notes	Not Applicable	Not Applicable	Not Applicable	Not Applicable

Valve Code	PSV-EB-2-C11F	PSV-EB-2-C11G	PSV-EB-2-C11H	PSV-EB-2-C11J
Specs	E9 E10	E9 E10	E9 E10	E9 E10
1. Valve Type	Balanced	Balanced	Balanced	Balanced
2. Orifice Size	Orifice F (0.307 in ²)	Orifice G (0.503 in ²)	Orifice H (0.785 in ²)	Orifice J (1.287 in ²)
3. Valve Specification Level (VSL)	VSL-2	VSL-2	VSL-2	VSL-2
4. Standard	API 520	API 520	API 520	API 520
5. Inlet/Outlet Size Range (NPS)	1 ½" x 2"	1 ½" x 3"	2" x 3"	3" x 4"
6. Inlet/Outlet end connection	ASME B16.5, RF x ASME B16.5, RF	ASME B16.5, RF x ASME B16.5, RF	ASME B16.5, RF x ASME B16.5, RF	ASME B16.5, RF x ASME B16.5, RF
7. Inlet/Outlet pressure class	600 x 150	600 x 150	600 x 150	600 x 150
8. Temperature	0°C to 240°C	0°C to 240°C	0°C to 240°C	0°C to 240°C
9. Material Class	Carbon Steel	Carbon Steel	Carbon Steel	Carbon Steel
10. Body and bonnet Material	ASTM A216 Gr WCB	ASTM A216 Gr WCB	ASTM A216 Gr WCB	ASTM A216 Gr WCB
11. Disc Material	Martensitic SS 400 Series	Martensitic SS 400 Series	Martensitic SS 400 Series	Martensitic SS 400 Series
12. Nozzle Material	AISI 316	AISI 316	AISI 316	AISI 316
13. Guide Material	AISI 316	AISI 316	AISI 316	AISI 316
14. Spindle Material	Martensitic SS 400 Series	Martensitic SS 400 Series	Martensitic SS 400 Series	Martensitic SS 400 Series
15. Spring Material	UNS N07750	UNS N07750	UNS N07750	UNS N07750
16. Bellow Material	UNS N06625	UNS N06625	UNS N06625	UNS N06625
17. Valve Testing	API 527	API 527	API 527	API 527
18. Notes	Not Applicable	Not Applicable	Not Applicable	Not Applicable

Valve Code	PSV-EB-2-C11K	PSV-EB-2-C11L	PSV-EB-2-C11M	PSV-EB-2-C11N
Specs	E9 E10	E9 E10	E9 E10	E9 E10
1. Valve Type	Balanced	Balanced	Balanced	Balanced
2. Orifice Size	Orifice K (1.838 in ²)	Orifice L (2.853 in ²)	Orifice M (3.60 in ²)	Orifice N (4.34 in ²)
3. Valve Specification Level (VSL)	VSL-2	VSL-2	VSL-2	VSL-2
4. Standard	API 520	API 520	API 520	API 520
5. Inlet/Outlet Size Range (NPS)	3" x 4"	4" x 6"	4" x 6"	4" x 6"
6. Inlet/Outlet end connection	ASME B16.5, RF x ASME B16.5, RF	ASME B16.5, RF x ASME B16.5, RF	ASME B16.5, RF x ASME B16.5, RF	ASME B16.5, RF x ASME B16.5, RF
7. Inlet/Outlet pressure class	600 x 150	600 x 150	600 x 150	600 x 150
8. Temperature	0°C to 240°C	0°C to 240°C	0°C to 240°C	0°C to 240°C
9. Material Class	Carbon Steel	Carbon Steel	Carbon Steel	Carbon Steel
10. Body and bonnet Material	ASTM A216 Gr WCB	ASTM A216 Gr WCB	ASTM A216 Gr WCB	ASTM A216 Gr WCB
11. Disc Material	Martensitic SS 400 Series	Martensitic SS 400 Series	Martensitic SS 400 Series	Martensitic SS 400 Series
12. Nozzle Material	AISI 316	AISI 316	AISI 316	AISI 316
13. Guide Material	AISI 316	AISI 316	AISI 316	AISI 316
14. Spindle Material	Martensitic SS 400 Series	Martensitic SS 400 Series	Martensitic SS 400 Series	Martensitic SS 400 Series
15. Spring Material	UNS N07750	UNS N07750	UNS N07750	UNS N07750
16. Bellow Material	UNS N06625	UNS N06625	UNS N06625	UNS N06625
17. Valve Testing	API 527	API 527	API 527	API 527
18. Notes	Not Applicable	Not Applicable	Not Applicable	Not Applicable

Valve Code	PSV-EB-2-C11P	PSV-EB-2-C11Q	PSV-EB-2-C11R	PSV-EB-2-C11T
Specs	E9 E10	E9 E10	E9 E10	E9 E10
1. Valve Type	Balanced	Balanced	Balanced	Balanced
2. Orifice Size	Orifice P (6.38 in ²)	Orifice Q (11.05 in ²)	Orifice R (16.00 in ²)	Orifice T (26.00 in ²)
3. Valve Specification Level (VSL)	VSL-2	VSL-2	VSL-2	VSL-2
4. Standard	API 520	API 520	API 520	API 520
5. Inlet/Outlet Size Range (NPS)	4" x 6"	6" x 8"	6" x 10"	8" x 10"
6. Inlet/Outlet end connection	ASME B16.5, RF x ASME B16.5, RF	ASME B16.5, RF x ASME B16.5, RF	ASME B16.5, RF x ASME B16.5, RF	ASME B16.5, RF x ASME B16.5, RF
7. Inlet/Outlet pressure class	600 x 150	600 x 150	600 x 150	600 x 150
8. Temperature	0°C to 240°C	0°C to 240°C	0°C to 240°C	0°C to 240°C
9. Material Class	Carbon Steel	Carbon Steel	Carbon Steel	Carbon Steel
10. Body and bonnet Material	ASTM A216 Gr WCB	ASTM A216 Gr WCB	ASTM A216 Gr WCB	ASTM A216 Gr WCB
11. Disc Material	Martensitic SS 400 Series	Martensitic SS 400 Series	Martensitic SS 400 Series	Martensitic SS 400 Series
12. Nozzle Material	AISI 316	AISI 316	AISI 316	AISI 316
13. Guide Material	AISI 316	AISI 316	AISI 316	AISI 316
14. Spindle Material	Martensitic SS 400 Series	Martensitic SS 400 Series	Martensitic SS 400 Series	Martensitic SS 400 Series
15. Spring Material	UNS N07750	UNS N07750	UNS N07750	UNS N07750
16. Bellow Material	UNS N06625	UNS N06625	UNS N06625	UNS N06625
17. Valve Testing	API 527	API 527	API 527	API 527
18. Notes	Not Applicable	Not Applicable	Not Applicable	Not Applicable

Valve Code	PSV-EB-2-C20D	PSV-EB-2-C20E	PSV-EB-2-C20F	PSV-EB-2-C20G
Specs	E6 E9 E10 E19	E6 E9 E10 E19	E6 E9 E10 E19	E6 E9 E10 E19
1. Valve Type	Conventional	Conventional	Conventional	Conventional
2. Orifice Size	Orifice D (A=0.110 in ²)	Orifice E (0.196 in ²)	Orifice F (0.307 in ²)	Orifice G (0.503 in ²)
3. Valve Specification Level (VSL)	VSL-2	VSL-2	VSL-2	VSL-2
4. Standard	API 520	API 520	API 520	API 520
5. Inlet/Outlet Size Range (NPS)	1" x 2"	1" x 2"	1 ½" x 2"	1 ½" x 3"
6. Inlet/Outlet end connection	ASME B16.5, RF x ASME B16.5, RF	ASME B16.5, RF x ASME B16.5, RF	ASME B16.5, RF x ASME B16.5, RF	ASME B16.5, RF x ASME B16.5, RF
7. Inlet/Outlet pressure class	600 x 150	600 x 150	600 x 150	600 x 150
8. Temperature	-46°C to 240°C	-46°C to 240°C	-46°C to 240°C	-46°C to 240°C
9. Material Class	Carbon Steel	Carbon Steel	Carbon Steel	Carbon Steel
10. Body and bonnet Material	ASTM A352 Gr LCB	ASTM A352 Gr LCB	ASTM A352 Gr LCB	ASTM A352 Gr LCB
11. Disc Material	AISI 316 + Stellite	AISI 316 + Stellite	AISI 316 + Stellite	AISI 316 + Stellite
12. Nozzle Material	AISI 316	AISI 316	AISI 316	AISI 316
13. Guide Material	AISI 316	AISI 316	AISI 316	AISI 316
14. Spindle Material	Martensitic SS 400 Series	Martensitic SS 400 Series	Martensitic SS 400 Series	Martensitic SS 400 Series
15. Spring Material	UNS N07750	UNS N07750	UNS N07750	UNS N07750
16. Bellow Material	Not applicable	Not applicable	Not applicable	Not applicable
17. Valve Testing	API 527	API 527	API 527	API 527
18. Notes	Not Applicable	Not Applicable	Not Applicable	Not Applicable

Valve Code	PSV-EB-2-C20H	PSV-EB-2-C20J	PSV-EB-2-C20K	PSV-EB-2-C20L
Specs	E6 E9 E10 E19	E6 E9 E10 E19	E6 E9 E10 E19	E6 E9 E10 E19
1. Valve Type	Conventional	Conventional	Conventional	Conventional
2. Orifice Size	Orifice H (0.785 in ²)	Orifice J (1.287 in ²)	Orifice K (1.838 in ²)	Orifice L (2.853 in ²)
3. Valve Specification Level (VSL)	VSL-2	VSL-2	VSL-2	VSL-2
4. Standard	API 520	API 520	API 520	API 520
5. Inlet/Outlet Size Range (NPS)	2" x 3"	3" x 4"	3" x 4"	4" x 6"
6. Inlet/Outlet end connection	ASME B16.5, RF x ASME B16.5, RF	ASME B16.5, RF x ASME B16.5, RF	ASME B16.5, RF x ASME B16.5, RF	ASME B16.5, RF x ASME B16.5, RF
7. Inlet/Outlet pressure class	600 x 150	600 x 150	600 x 150	600 x 150
8. Temperature	-46°C to 240°C	-46°C to 240°C	-46°C to 240°C	-46°C to 240°C
9. Material Class	Carbon Steel	Carbon Steel	Carbon Steel	Carbon Steel
10. Body and bonnet Material	ASTM A352 Gr LCB	ASTM A352 Gr LCB	ASTM A352 Gr LCB	ASTM A352 Gr LCB
11. Disc Material	AISI 316 + Stellite	AISI 316 + Stellite	AISI 316 + Stellite	AISI 316 + Stellite
12. Nozzle Material	AISI 316	AISI 316	AISI 316	AISI 316
13. Guide Material	AISI 316	AISI 316	AISI 316	AISI 316
14. Spindle Material	Martensitic SS 400 Series	Martensitic SS 400 Series	Martensitic SS 400 Series	Martensitic SS 400 Series
15. Spring Material	UNS N07750	UNS N07750	UNS N07750	UNS N07750
16. Bellow Material	Not applicable	Not applicable	Not applicable	Not applicable
17. Valve Testing	API 527	API 527	API 527	API 527
18. Notes	Not Applicable	Not Applicable	Not Applicable	Not Applicable

Valve Code	PSV-EB-2-C20M	PSV-EB-2-C20N	PSV-EB-2-C20P	PSV-EB-2-C20Q
Specs	E6 E9 E10 E19	E6 E9 E10 E19	E6 E9 E10 E19	E6 E9 E10 E19
1. Valve Type	Conventional	Conventional	Conventional	Conventional
2. Orifice Size	Orifice M (3.60 in ²)	Orifice N (4.34 in ²)	Orifice P (6.38 in ²)	Orifice Q (11.05 in ²)
3. Valve Specification Level (VSL)	VSL-2	VSL-2	VSL-2	VSL-2
4. Standard	API 520	API 520	API 520	API 520
5. Inlet/Outlet Size Range (NPS)	4" x 6"	4" x 6"	4" x 6"	6" x 8"
6. Inlet/Outlet end connection	ASME B16.5, RF x ASME B16.5, RF	ASME B16.5, RF x ASME B16.5, RF	ASME B16.5, RF x ASME B16.5, RF	ASME B16.5, RF x ASME B16.5, RF
7. Inlet/Outlet pressure class	600 x 150	600 x 150	600 x 150	600 x 150
8. Temperature	-46°C to 240°C	-46°C to 240°C	-46°C to 240°C	-46°C to 240°C
9. Material Class	Carbon Steel	Carbon Steel	Carbon Steel	Carbon Steel
10. Body and bonnet Material	ASTM A352 Gr LCB	ASTM A352 Gr LCB	ASTM A352 Gr LCB	ASTM A352 Gr LCB
11. Disc Material	AISI 316 + Stellite	AISI 316 + Stellite	AISI 316 + Stellite	AISI 316 + Stellite
12. Nozzle Material	AISI 316	AISI 316	AISI 316	AISI 316
13. Guide Material	AISI 316	AISI 316	AISI 316	AISI 316
14. Spindle Material	Martensitic SS 400 Series	Martensitic SS 400 Series	Martensitic SS 400 Series	Martensitic SS 400 Series
15. Spring Material	UNS N07750	UNS N07750	UNS N07750	UNS N07750
16. Bellow Material	Not applicable	Not applicable	Not applicable	Not applicable
17. Valve Testing	API 527	API 527	API 527	API 527
18. Notes	Not Applicable	Not Applicable	Not Applicable	Not Applicable

Valve Code	PSV-EB-2-C20R	PSV-EB-2-C20T	PSV-EB-2-C21D	PSV-EB-2-C21E
Specs	E6 E9 E10 E19	E6 E9 E10 E19	E6 E9 E10 E19	E6 E9 E10 E19
1. Valve Type	Conventional	Conventional	Balanced	Balanced
2. Orifice Size	Orifice R (16.00 in ²)	Orifice T (26.00 in ²)	Orifice D (A=0.110 in ²)	Orifice E (0.196 in ²)
3. Valve Specification Level (VSL)	VSL-2	VSL-2	VSL-2	VSL-2
4. Standard	API 520	API 520	API 520	API 520
5. Inlet/Outlet Size Range (NPS)	6" x 10"	8" x 10"	1" x 2"	1" x 2"
6. Inlet/Outlet end connection	ASME B16.5, RF x ASME B16.5, RF	ASME B16.5, RF x ASME B16.5, RF	ASME B16.5, RF x ASME B16.5, RF	ASME B16.5, RF x ASME B16.5, RF
7. Inlet/Outlet pressure class	600 x 150	600 x 150	600 x 150	600 x 150
8. Temperature	-46°C to 240°C	-46°C to 240°C	-46°C to 240°C	-46°C to 240°C
9. Material Class	Carbon Steel	Carbon Steel	Carbon Steel	Carbon Steel
10. Body and bonnet Material	ASTM A352 Gr LCB	ASTM A352 Gr LCB	ASTM A352 Gr LCB	ASTM A352 Gr LCB
11. Disc Material	AISI 316 + Stellite	AISI 316 + Stellite	AISI 316 + Stellite	AISI 316 + Stellite
12. Nozzle Material	AISI 316	AISI 316	AISI 316	AISI 316
13. Guide Material	AISI 316	AISI 316	AISI 316	AISI 316
14. Spindle Material	Martensitic SS 400 Series	Martensitic SS 400 Series	Martensitic SS 400 Series	Martensitic SS 400 Series
15. Spring Material	UNS N07750	UNS N07750	UNS N07750	UNS N07750
16. Bellow Material	Not applicable	Not applicable	UNS N06625	UNS N06625
17. Valve Testing	API 527	API 527	API 527	API 527
18. Notes	Not Applicable	Not Applicable	Not Applicable	Not Applicable

Valve Code	PSV-EB-2-C21F	PSV-EB-2-C21G	PSV-EB-2-C21H	PSV-EB-2-C21J
Specs	E6 E9 E10 E19	E6 E9 E10 E19	E6 E9 E10 E19	E6 E9 E10 E19
1. Valve Type	Balanced	Balanced	Balanced	Balanced
2. Orifice Size	Orifice F (0.307 in ²)	Orifice G (0.503 in ²)	Orifice H (0.785 in ²)	Orifice J (1.287 in ²)
3. Valve Specification Level (VSL)	VSL-2	VSL-2	VSL-2	VSL-2
4. Standard	API 520	API 520	API 520	API 520
5. Inlet/Outlet Size Range (NPS)	1 ½" x 2"	1 ½" x 3"	2" x 3"	3" x 4"
6. Inlet/Outlet end connection	ASME B16.5, RF x ASME B16.5, RF	ASME B16.5, RF x ASME B16.5, RF	ASME B16.5, RF x ASME B16.5, RF	ASME B16.5, RF x ASME B16.5, RF
7. Inlet/Outlet pressure class	600 x 150	600 x 150	600 x 150	600 x 150
8. Temperature	-46°C to 240°C	-46°C to 240°C	-46°C to 240°C	-46°C to 240°C
9. Material Class	Carbon Steel	Carbon Steel	Carbon Steel	Carbon Steel
10. Body and bonnet Material	ASTM A352 Gr LCB	ASTM A352 Gr LCB	ASTM A352 Gr LCB	ASTM A352 Gr LCB
11. Disc Material	AISI 316 + Stellite	AISI 316 + Stellite	AISI 316 + Stellite	AISI 316 + Stellite
12. Nozzle Material	AISI 316	AISI 316	AISI 316	AISI 316
13. Guide Material	AISI 316	AISI 316	AISI 316	AISI 316
14. Spindle Material	Martensitic SS 400 Series	Martensitic SS 400 Series	Martensitic SS 400 Series	Martensitic SS 400 Series
15. Spring Material	UNS N07750	UNS N07750	UNS N07750	UNS N07750
16. Bellow Material	UNS N06625	UNS N06625	UNS N06625	UNS N06625
17. Valve Testing	API 527	API 527	API 527	API 527
18. Notes	Not Applicable	Not Applicable	Not Applicable	Not Applicable

Valve Code	PSV-EB-2-C21K	PSV-EB-2-C21L	PSV-EB-2-C21M	PSV-EB-2-C21N
Specs	E6 E9 E10 E19	E6 E9 E10 E19	E6 E9 E10 E19	E6 E9 E10 E19
1. Valve Type	Balanced	Balanced	Balanced	Balanced
2. Orifice Size	Orifice K (1.838 in ²)	Orifice L (2.853 in ²)	Orifice M (3.60 in ²)	Orifice N (4.34 in ²)
3. Valve Specification Level (VSL)	VSL-2	VSL-2	VSL-2	VSL-2
4. Standard	API 520	API 520	API 520	API 520
5. Inlet/Outlet Size Range (NPS)	3" x 4"	4" x 6"	4" x 6"	4" x 6"
6. Inlet/Outlet end connection	ASME B16.5, RF x ASME B16.5, RF	ASME B16.5, RF x ASME B16.5, RF	ASME B16.5, RF x ASME B16.5, RF	ASME B16.5, RF x ASME B16.5, RF
7. Inlet/Outlet pressure class	600 x 150	600 x 150	600 x 150	600 x 150
8. Temperature	-46°C to 240°C	-46°C to 240°C	-46°C to 240°C	-46°C to 240°C
9. Material Class	Carbon Steel	Carbon Steel	Carbon Steel	Carbon Steel
10. Body and bonnet Material	ASTM A352 Gr LCB	ASTM A352 Gr LCB	ASTM A352 Gr LCB	ASTM A352 Gr LCB
11. Disc Material	AISI 316 + Stellite	AISI 316 + Stellite	AISI 316 + Stellite	AISI 316 + Stellite
12. Nozzle Material	AISI 316	AISI 316	AISI 316	AISI 316
13. Guide Material	AISI 316	AISI 316	AISI 316	AISI 316
14. Spindle Material	Martensitic SS 400 Series	Martensitic SS 400 Series	Martensitic SS 400 Series	Martensitic SS 400 Series
15. Spring Material	UNS N07750	UNS N07750	UNS N07750	UNS N07750
16. Bellow Material	UNS N06625	UNS N06625	UNS N06625	UNS N06625
17. Valve Testing	API 527	API 527	API 527	API 527
18. Notes	Not Applicable	Not Applicable	Not Applicable	Not Applicable

Valve Code	PSV-EB-2-C21P	PSV-EB-2-C21Q	PSV-EB-2-C21R	PSV-EB-2-C21T
Specs	E6 E9 E10 E19	E6 E9 E10 E19	E6 E9 E10 E19	E6 E9 E10 E19
1. Valve Type	Balanced	Balanced	Balanced	Balanced
2. Orifice Size	Orifice P (6.38 in ²)	Orifice Q (11.05 in ²)	Orifice R (16.00 in ²)	Orifice T (26.00 in ²)
3. Valve Specification Level (VSL)	VSL-2	VSL-2	VSL-2	VSL-2
4. Standard	API 520	API 520	API 520	API 520
5. Inlet/Outlet Size Range (NPS)	4" x 6"	6" x 8"	6" x 10"	8" x 10"
6. Inlet/Outlet end connection	ASME B16.5, RF x ASME B16.5, RF	ASME B16.5, RF x ASME B16.5, RF	ASME B16.5, RF x ASME B16.5, RF	ASME B16.5, RF x ASME B16.5, RF
7. Inlet/Outlet pressure class	600 x 150	600 x 150	600 x 150	600 x 150
8. Temperature	-46°C to 240°C	-46°C to 240°C	-46°C to 240°C	-46°C to 240°C
9. Material Class	Carbon Steel	Carbon Steel	Carbon Steel	Carbon Steel
10. Body and bonnet Material	ASTM A352 Gr LCB	ASTM A352 Gr LCB	ASTM A352 Gr LCB	ASTM A352 Gr LCB
11. Disc Material	AISI 316 + Stellite	AISI 316 + Stellite	AISI 316 + Stellite	AISI 316 + Stellite
12. Nozzle Material	AISI 316	AISI 316	AISI 316	AISI 316
13. Guide Material	AISI 316	AISI 316	AISI 316	AISI 316
14. Spindle Material	Martensitic SS 400 Series	Martensitic SS 400 Series	Martensitic SS 400 Series	Martensitic SS 400 Series
15. Spring Material	UNS N07750	UNS N07750	UNS N07750	UNS N07750
16. Bellow Material	UNS N06625	UNS N06625	UNS N06625	UNS N06625
17. Valve Testing	API 527	API 527	API 527	API 527
18. Notes	Not Applicable	Not Applicable	Not Applicable	Not Applicable

Valve Code	PSV-EB-2-D21D	PSV-EB-2-D21E	PSV-EB-2-D21F	PSV-EB-2-D21G
Specs	E16	E16	E16	E16
1. Valve Type	Balanced	Balanced	Balanced	Balanced
2. Orifice Size	Orifice D (A=0.110 in ²)	Orifice E (0.196 in ²)	Orifice F (0.307 in ²)	Orifice G (0.503 in ²)
3. Valve Specification Level (VSL)	VSL-2	VSL-2	VSL-2	VSL-2
4. Standard	API 520	API 520	API 520	API 520
5. Inlet/Outlet Size Range (NPS)	1" x 2"	1" x 2"	1 ½" x 2"	1 ½" x 3"
6. Inlet/Outlet end connection	ASME B16.5, RF x ASME B16.5, RF	ASME B16.5, RF x ASME B16.5, RF	ASME B16.5, RF x ASME B16.5, RF	ASME B16.5, RF x ASME B16.5, RF
7. Inlet/Outlet pressure class	600 x 150	600 x 150	600 x 150	600 x 150
8. Temperature	-50°C to 100°C	-50°C to 100°C	-50°C to 100°C	-50°C to 100°C
9. Material Class	Duplex Steel	Duplex Steel	Duplex Steel	Duplex Steel
10. Body and bonnet Material	ASTM A995 Gr 4a	ASTM A995 Gr 4a	ASTM A995 Gr 4a	ASTM A995 Gr 4a
11. Disc Material	ASTM A479 (UNS S31803)	ASTM A479 (UNS S31803)	ASTM A479 (UNS S31803)	ASTM A479 (UNS S31803)
12. Nozzle Material	ASTM A479 (UNS S31803)	ASTM A479 (UNS S31803)	ASTM A479 (UNS S31803)	ASTM A479 (UNS S31803)
13. Guide Material	AISI 316	AISI 316	AISI 316	AISI 316
14. Spindle Material	Martensitic SS 400 Series	Martensitic SS 400 Series	Martensitic SS 400 Series	Martensitic SS 400 Series
15. Spring Material	UNS N07750	UNS N07750	UNS N07750	UNS N07750
16. Bellow Material	UNS N06625	UNS N06625	UNS N06625	UNS N06625
17. Valve Testing	API 527	API 527	API 527	API 527
18. Notes	Not Applicable	Not Applicable	Not Applicable	Not Applicable

Valve Code	PSV-EB-2-D21H	PSV-EB-2-D21J	PSV-EB-2-D21K	PSV-EB-2-D21L
Specs	E16	E16	E16	E16
1. Valve Type	Balanced	Balanced	Balanced	Balanced
2. Orifice Size	Orifice H (0.785 in ²)	Orifice J (1.287 in ²)	Orifice K (1.838 in ²)	Orifice L (2.853 in ²)
3. Valve Specification Level (VSL)	VSL-2	VSL-2	VSL-2	VSL-2
4. Standard	API 520	API 520	API 520	API 520
5. Inlet/Outlet Size Range (NPS)	2" x 3"	3" x 4"	3" x 4"	4" x 6"
6. Inlet/Outlet end connection	ASME B16.5, RF x ASME B16.5, RF	ASME B16.5, RF x ASME B16.5, RF	ASME B16.5, RF x ASME B16.5, RF	ASME B16.5, RF x ASME B16.5, RF
7. Inlet/Outlet pressure class	600 x 150	600 x 150	600 x 150	600 x 150
8. Temperature	-50°C to 100°C	-50°C to 100°C	-50°C to 100°C	-50°C to 100°C
9. Material Class	Duplex Steel	Duplex Steel	Duplex Steel	Duplex Steel
10. Body and bonnet Material	ASTM A995 Gr 4a	ASTM A995 Gr 4a	ASTM A995 Gr 4a	ASTM A995 Gr 4a
11. Disc Material	ASTM A479 (UNS S31803)	ASTM A479 (UNS S31803)	ASTM A479 (UNS S31803)	ASTM A479 (UNS S31803)
12. Nozzle Material	ASTM A479 (UNS S31803)	ASTM A479 (UNS S31803)	ASTM A479 (UNS S31803)	ASTM A479 (UNS S31803)
13. Guide Material	AISI 316	AISI 316	AISI 316	AISI 316
14. Spindle Material	Martensitic SS 400 Series	Martensitic SS 400 Series	Martensitic SS 400 Series	Martensitic SS 400 Series
15. Spring Material	UNS N07750	UNS N07750	UNS N07750	UNS N07750
16. Bellow Material	UNS N06625	UNS N06625	UNS N06625	UNS N06625
17. Valve Testing	API 527	API 527	API 527	API 527
18. Notes	Not Applicable	Not Applicable	Not Applicable	Not Applicable

Valve Code	PSV-EB-2-D21M	PSV-EB-2-D21N	PSV-EB-2-D21P	PSV-EB-2-D21Q
Specs	E16	E16	E16	E16
1. Valve Type	Balanced	Balanced	Balanced	Balanced
2. Orifice Size	Orifice M (3.60 in ²)	Orifice N (4.34 in ²)	Orifice P (6.38 in ²)	Orifice Q (11.05 in ²)
3. Valve Specification Level (VSL)	VSL-2	VSL-2	VSL-2	VSL-2
4. Standard	API 520	API 520	API 520	API 520
5. Inlet/Outlet Size Range (NPS)	4" x 6"	4" x 6"	4" x 6"	6" x 8"
6. Inlet/Outlet end connection	ASME B16.5, RF x ASME B16.5, RF	ASME B16.5, RF x ASME B16.5, RF	ASME B16.5, RF x ASME B16.5, RF	ASME B16.5, RF x ASME B16.5, RF
7. Inlet/Outlet pressure class	600 x 150	600 x 150	600 x 150	600 x 150
8. Temperature	-50°C to 100°C	-50°C to 100°C	-50°C to 100°C	-50°C to 100°C
9. Material Class	Duplex Steel	Duplex Steel	Duplex Steel	Duplex Steel
10. Body and bonnet Material	ASTM A995 Gr 4a	ASTM A995 Gr 4a	ASTM A995 Gr 4a	ASTM A995 Gr 4a
11. Disc Material	ASTM A479 (UNS S31803)	ASTM A479 (UNS S31803)	ASTM A479 (UNS S31803)	ASTM A479 (UNS S31803)
12. Nozzle Material	ASTM A479 (UNS S31803)	ASTM A479 (UNS S31803)	ASTM A479 (UNS S31803)	ASTM A479 (UNS S31803)
13. Guide Material	AISI 316	AISI 316	AISI 316	AISI 316
14. Spindle Material	Martensitic SS 400 Series	Martensitic SS 400 Series	Martensitic SS 400 Series	Martensitic SS 400 Series
15. Spring Material	UNS N07750	UNS N07750	UNS N07750	UNS N07750
16. Bellow Material	UNS N06625	UNS N06625	UNS N06625	UNS N06625
17. Valve Testing	API 527	API 527	API 527	API 527
18. Notes	Not Applicable	Not Applicable	Not Applicable	Not Applicable

Valve Code	PSV-EB-2-D21R	PSV-EB-2-D21T	PSV-EB-2-N11D	PSV-EB-2-N11E
Specs	E16	E16	E30	E30
1. Valve Type	Balanced	Balanced	Balanced	Balanced
2. Orifice Size	Orifice R (16.00 in ²)	Orifice T (26.00 in ²)	Orifice D (A=0.110 in ²)	Orifice E (0.196 in ²)
3. Valve Specification Level (VSL)	VSL-2	VSL-2	VSL-2	VSL-2
4. Standard	API 520	API 520	API 520	API 520
5. Inlet/Outlet Size Range (NPS)	6" x 10"	8" x 10"	1" x 2"	1" x 2"
6. Inlet/Outlet end connection	ASME B16.5, RF x ASME B16.5, RF	ASME B16.5, RF x ASME B16.5, RF	ASME B16.5, RF x ASME B16.5, RF	ASME B16.5, RF x ASME B16.5, RF
7. Inlet/Outlet pressure class	600 x 150	600 x 150	600 x 150	600 x 150
8. Temperature	-50°C to 100°C	-50°C to 100°C	-100°C to 155°C	-100°C to 155°C
9. Material Class	Duplex Steel	Duplex Steel	Nickel Alloys	Nickel Alloys
10. Body and bonnet Material	ASTM A995 Gr 4a	ASTM A995 Gr 4a	UNS N06625	UNS N06625
11. Disc Material	ASTM A479 (UNS S31803)	ASTM A479 (UNS S31803)	UNS N06625	UNS N06625
12. Nozzle Material	ASTM A479 (UNS S31803)	ASTM A479 (UNS S31803)	ASTM B564 (UNS N06625)	ASTM B564 (UNS N06625)
13. Guide Material	AISI 316	AISI 316	AISI 316	AISI 316
14. Spindle Material	Martensitic SS 400 Series	Martensitic SS 400 Series	Martensitic SS 400 Series	Martensitic SS 400 Series
15. Spring Material	UNS N07750	UNS N07750	UNS N07750	UNS N07750
16. Bellow Material	UNS N06625	UNS N06625	UNS N06625	UNS N06625
17. Valve Testing	API 527	API 527	API 527	API 527
18. Notes	Not Applicable	Not Applicable	Not Applicable	Not Applicable

Valve Code	PSV-EB-2-N11F	PSV-EB-2-N11G	PSV-EB-2-N11H	PSV-EB-2-N11J
Specs	E30	E30	E30	E30
1. Valve Type	Balanced	Balanced	Balanced	Balanced
2. Orifice Size	Orifice F (0.307 in ²)	Orifice G (0.503 in ²)	Orifice H (0.785 in ²)	Orifice J (1.287 in ²)
3. Valve Specification Level (VSL)	VSL-2	VSL-2	VSL-2	VSL-2
4. Standard	API 520	API 520	API 520	API 520
5. Inlet/Outlet Size Range (NPS)	1 ½" x 2"	1 ½" x 3"	2" x 3"	3" x 4"
6. Inlet/Outlet end connection	ASME B16.5, RF x ASME B16.5, RF	ASME B16.5, RF x ASME B16.5, RF	ASME B16.5, RF x ASME B16.5, RF	ASME B16.5, RF x ASME B16.5, RF
7. Inlet/Outlet pressure class	600 x 150	600 x 150	600 x 150	600 x 150
8. Temperature	-100°C to 155°C	-100°C to 155°C	-100°C to 155°C	-100°C to 155°C
9. Material Class	Nickel Alloys	Nickel Alloys	Nickel Alloys	Nickel Alloys
10. Body and bonnet Material	UNS N06625	UNS N06625	UNS N06625	UNS N06625
11. Disc Material	UNS N06625	UNS N06625	UNS N06625	UNS N06625
12. Nozzle Material	ASTM B564 (UNS N06625)	ASTM B564 (UNS N06625)	ASTM B564 (UNS N06625)	ASTM B564 (UNS N06625)
13. Guide Material	AISI 316	AISI 316	AISI 316	AISI 316
14. Spindle Material	Martensitic SS 400 Series	Martensitic SS 400 Series	Martensitic SS 400 Series	Martensitic SS 400 Series
15. Spring Material	UNS N07750	UNS N07750	UNS N07750	UNS N07750
16. Bellow Material	UNS N06625	UNS N06625	UNS N06625	UNS N06625
17. Valve Testing	API 527	API 527	API 527	API 527
18. Notes	Not Applicable	Not Applicable	Not Applicable	Not Applicable

Valve Code	PSV-EB-2-N11K	PSV-EB-2-N11L	PSV-EB-2-N11M	PSV-EB-2-N11N
Specs	E30	E30	E30	E30
1. Valve Type	Balanced	Balanced	Balanced	Balanced
2. Orifice Size	Orifice K (1.838 in ²)	Orifice L (2.853 in ²)	Orifice M (3.60 in ²)	Orifice N (4.34 in ²)
3. Valve Specification Level (VSL)	VSL-2	VSL-2	VSL-2	VSL-2
4. Standard	API 520	API 520	API 520	API 520
5. Inlet/Outlet Size Range (NPS)	3" x 4"	4" x 6"	4" x 6"	4" x 6"
6. Inlet/Outlet end connection	ASME B16.5, RF x ASME B16.5, RF	ASME B16.5, RF x ASME B16.5, RF	ASME B16.5, RF x ASME B16.5, RF	ASME B16.5, RF x ASME B16.5, RF
7. Inlet/Outlet pressure class	600 x 150	600 x 150	600 x 150	600 x 150
8. Temperature	-100°C to 155°C	-100°C to 155°C	-100°C to 155°C	-100°C to 155°C
9. Material Class	Nickel Alloys	Nickel Alloys	Nickel Alloys	Nickel Alloys
10. Body and bonnet Material	UNS N06625	UNS N06625	UNS N06625	UNS N06625
11. Disc Material	UNS N06625	UNS N06625	UNS N06625	UNS N06625
12. Nozzle Material	ASTM B564 (UNS N06625)	ASTM B564 (UNS N06625)	ASTM B564 (UNS N06625)	ASTM B564 (UNS N06625)
13. Guide Material	AISI 316	AISI 316	AISI 316	AISI 316
14. Spindle Material	Martensitic SS 400 Series	Martensitic SS 400 Series	Martensitic SS 400 Series	Martensitic SS 400 Series
15. Spring Material	UNS N07750	UNS N07750	UNS N07750	UNS N07750
16. Bellow Material	UNS N06625	UNS N06625	UNS N06625	UNS N06625
17. Valve Testing	API 527	API 527	API 527	API 527
18. Notes	Not Applicable	Not Applicable	Not Applicable	Not Applicable

Valve Code	PSV-EB-2-N11P	PSV-EB-2-N11Q	PSV-EB-2-N11R	PSV-EB-2-N11T
Specs	E30	E30	E30	E30
1. Valve Type	Balanced	Balanced	Balanced	Balanced
2. Orifice Size	Orifice P (6.38 in ²)	Orifice Q (11.05 in ²)	Orifice R (16.00 in ²)	Orifice T (26.00 in ²)
3. Valve Specification Level (VSL)	VSL-2	VSL-2	VSL-2	VSL-2
4. Standard	API 520	API 520	API 520	API 520
5. Inlet/Outlet Size Range (NPS)	4" x 6"	6" x 8"	6" x 10"	8" x 10"
6. Inlet/Outlet end connection	ASME B16.5, RF x ASME B16.5, RF	ASME B16.5, RF x ASME B16.5, RF	ASME B16.5, RF x ASME B16.5, RF	ASME B16.5, RF x ASME B16.5, RF
7. Inlet/Outlet pressure class	600 x 150	600 x 150	600 x 150	600 x 150
8. Temperature	-100°C to 155°C	-100°C to 155°C	-100°C to 155°C	-100°C to 155°C
9. Material Class	Nickel Alloys	Nickel Alloys	Nickel Alloys	Nickel Alloys
10. Body and bonnet Material	UNS N06625	UNS N06625	UNS N06625	UNS N06625
11. Disc Material	UNS N06625	UNS N06625	UNS N06625	UNS N06625
12. Nozzle Material	ASTM B564 (UNS N06625)	ASTM B564 (UNS N06625)	ASTM B564 (UNS N06625)	ASTM B564 (UNS N06625)
13. Guide Material	AISI 316	AISI 316	AISI 316	AISI 316
14. Spindle Material	Martensitic SS 400 Series	Martensitic SS 400 Series	Martensitic SS 400 Series	Martensitic SS 400 Series
15. Spring Material	UNS N07750	UNS N07750	UNS N07750	UNS N07750
16. Bellow Material	UNS N06625	UNS N06625	UNS N06625	UNS N06625
17. Valve Testing	API 527	API 527	API 527	API 527
18. Notes	Not Applicable	Not Applicable	Not Applicable	Not Applicable

Valve Code	PSV-EB-2-S21D	PSV-EB-2-S21E	PSV-EB-2-S21F	PSV-EB-2-S21G
Specs	E3 E6 E9 E10 E19	E3 E6 E9 E10 E19	E3 E6 E9 E10 E19	E3 E6 E9 E10 E19
1. Valve Type	Balanced	Balanced	Balanced	Balanced
2. Orifice Size	Orifice D (A=0.110 in ²)	Orifice E (0.196 in ²)	Orifice F (0.307 in ²)	Orifice G (0.503 in ²)
3. Valve Specification Level (VSL)	VSL-2	VSL-2	VSL-2	VSL-2
4. Standard	API 520	API 520	API 520	API 520
5. Inlet/Outlet Size Range (NPS)	1" x 2"	1" x 2"	1 ½" x 2"	1 ½" x 3"
6. Inlet/Outlet end connection	ASME B16.5, RF x ASME B16.5, RF	ASME B16.5, RF x ASME B16.5, RF	ASME B16.5, RF x ASME B16.5, RF	ASME B16.5, RF x ASME B16.5, RF
7. Inlet/Outlet pressure class	600 x 150	600 x 150	600 x 150	600 x 150
8. Temperature	-100°C to 260°C	-100°C to 260°C	-100°C to 260°C	-100°C to 260°C
9. Material Class	Stainless Steel	Stainless Steel	Stainless Steel	Stainless Steel
10. Body and bonnet Material	ASTM A182 Gr CF8M	ASTM A182 Gr CF8M	ASTM A182 Gr CF8M	ASTM A182 Gr CF8M
11. Disc Material	AISI 316 + Stellite	AISI 316 + Stellite	AISI 316 + Stellite	AISI 316 + Stellite
12. Nozzle Material	AISI 316	AISI 316	AISI 316	AISI 316
13. Guide Material	AISI 316	AISI 316	AISI 316	AISI 316
14. Spindle Material	Martensitic SS 400 Series	Martensitic SS 400 Series	Martensitic SS 400 Series	Martensitic SS 400 Series
15. Spring Material	UNS N07750	UNS N07750	UNS N07750	UNS N07750
16. Bellow Material	UNS N06625	UNS N06625	UNS N06625	UNS N06625
17. Valve Testing	API 527	API 527	API 527	API 527
18. Notes	Not Applicable	Not Applicable	Not Applicable	Not Applicable

Valve Code	PSV-EB-2-S21H	PSV-EB-2-S21J	PSV-EB-2-S21K	PSV-EB-2-S21L
Specs	E3 E6 E9 E10 E19	E3 E6 E9 E10 E19	E3 E6 E9 E10 E19	E3 E6 E9 E10 E19
1. Valve Type	Balanced	Balanced	Balanced	Balanced
2. Orifice Size	Orifice H (0.785 in ²)	Orifice J (1.287 in ²)	Orifice K (1.838 in ²)	Orifice L (2.853 in ²)
3. Valve Specification Level (VSL)	VSL-2	VSL-2	VSL-2	VSL-2
4. Standard	API 520	API 520	API 520	API 520
5. Inlet/Outlet Size Range (NPS)	2" x 3"	3" x 4"	3" x 4"	4" x 6"
6. Inlet/Outlet end connection	ASME B16.5, RF x ASME B16.5, RF	ASME B16.5, RF x ASME B16.5, RF	ASME B16.5, RF x ASME B16.5, RF	ASME B16.5, RF x ASME B16.5, RF
7. Inlet/Outlet pressure class	600 x 150	600 x 150	600 x 150	600 x 150
8. Temperature	-100°C to 260°C	-100°C to 260°C	-100°C to 260°C	-100°C to 260°C
9. Material Class	Stainless Steel	Stainless Steel	Stainless Steel	Stainless Steel
10. Body and bonnet Material	ASTM A182 Gr CF8M	ASTM A182 Gr CF8M	ASTM A182 Gr CF8M	ASTM A182 Gr CF8M
11. Disc Material	AISI 316 + Stellite	AISI 316 + Stellite	AISI 316 + Stellite	AISI 316 + Stellite
12. Nozzle Material	AISI 316	AISI 316	AISI 316	AISI 316
13. Guide Material	AISI 316	AISI 316	AISI 316	AISI 316
14. Spindle Material	Martensitic SS 400 Series	Martensitic SS 400 Series	Martensitic SS 400 Series	Martensitic SS 400 Series
15. Spring Material	UNS N07750	UNS N07750	UNS N07750	UNS N07750
16. Bellow Material	UNS N06625	UNS N06625	UNS N06625	UNS N06625
17. Valve Testing	API 527	API 527	API 527	API 527
18. Notes	Not Applicable	Not Applicable	Not Applicable	Not Applicable

Valve Code	PSV-EB-2-S21M	PSV-EB-2-S21N	PSV-EB-2-S21P	PSV-EB-2-S21Q
Specs	E3 E6 E9 E10 E19	E3 E6 E9 E10 E19	E3 E6 E9 E10 E19	E3 E6 E9 E10 E19
1. Valve Type	Balanced	Balanced	Balanced	Balanced
2. Orifice Size	Orifice M (3.60 in ²)	Orifice N (4.34 in ²)	Orifice P (6.38 in ²)	Orifice Q (11.05 in ²)
3. Valve Specification Level (VSL)	VSL-2	VSL-2	VSL-2	VSL-2
4. Standard	API 520	API 520	API 520	API 520
5. Inlet/Outlet Size Range (NPS)	4" x 6"	4" x 6"	4" x 6"	6" x 8"
6. Inlet/Outlet end connection	ASME B16.5, RF x ASME B16.5, RF	ASME B16.5, RF x ASME B16.5, RF	ASME B16.5, RF x ASME B16.5, RF	ASME B16.5, RF x ASME B16.5, RF
7. Inlet/Outlet pressure class	600 x 150	600 x 150	600 x 150	600 x 150
8. Temperature	-100°C to 260°C	-100°C to 260°C	-100°C to 260°C	-100°C to 260°C
9. Material Class	Stainless Steel	Stainless Steel	Stainless Steel	Stainless Steel
10. Body and bonnet Material	ASTM A182 Gr CF8M	ASTM A182 Gr CF8M	ASTM A182 Gr CF8M	ASTM A182 Gr CF8M
11. Disc Material	AISI 316 + Stellite	AISI 316 + Stellite	AISI 316 + Stellite	AISI 316 + Stellite
12. Nozzle Material	AISI 316	AISI 316	AISI 316	AISI 316
13. Guide Material	AISI 316	AISI 316	AISI 316	AISI 316
14. Spindle Material	Martensitic SS 400 Series	Martensitic SS 400 Series	Martensitic SS 400 Series	Martensitic SS 400 Series
15. Spring Material	UNS N07750	UNS N07750	UNS N07750	UNS N07750
16. Bellow Material	UNS N06625	UNS N06625	UNS N06625	UNS N06625
17. Valve Testing	API 527	API 527	API 527	API 527
18. Notes	Not Applicable	Not Applicable	Not Applicable	Not Applicable

Valve Code	PSV-EB-2-S21R	PSV-EB-2-S21T	PSV-FB-1-C10H	PSV-FB-1-C10J
Specs	E3 E6 E9 E10 E19	E3 E6 E9 E10 E19	F10	F10
1. Valve Type	Balanced	Balanced	Conventional	Conventional
2. Orifice Size	Orifice R (16.00 in ²)	Orifice T (26.00 in ²)	Orifice H (0.785 in ²)	Orifice J (1.287 in ²)
3. Valve Specification Level (VSL)	VSL-2	VSL-2	VSL-1	VSL-1
4. Standard	API 520	API 520	API 520	API 520
5. Inlet/Outlet Size Range (NPS)	6" x 10"	8" x 10"	2" x 3"	3" x 4"
6. Inlet/Outlet end connection	ASME B16.5, RF x ASME B16.5, RF	ASME B16.5, RF x ASME B16.5, RF	ASME B16.5, RTJ x ASME B16.5, RF	ASME B16.5, RTJ x ASME B16.5, RF
7. Inlet/Outlet pressure class	600 x 150	600 x 150	900 x 150	900 x 150
8. Temperature	-100°C to 260°C	-100°C to 260°C	0°C to 240°C	0°C to 240°C
9. Material Class	Stainless Steel	Stainless Steel	Carbon Steel	Carbon Steel
10. Body and bonnet Material	ASTM A182 Gr CF8M	ASTM A182 Gr CF8M	ASTM A216 Gr WCB	ASTM A216 Gr WCB
11. Disc Material	AISI 316 + Stellite	AISI 316 + Stellite	Martensitic SS 400 Series	Martensitic SS 400 Series
12. Nozzle Material	AISI 316	AISI 316	AISI 316	AISI 316
13. Guide Material	AISI 316	AISI 316	AISI 316	AISI 316
14. Spindle Material	Martensitic SS 400 Series	Martensitic SS 400 Series	Martensitic SS 400 Series	Martensitic SS 400 Series
15. Spring Material	UNS N07750	UNS N07750	UNS N07750	UNS N07750
16. Bellow Material	UNS N06625	UNS N06625	Not applicable	Not applicable
17. Valve Testing	API 527	API 527	API 527	API 527
18. Notes	Not Applicable	Not Applicable	Not Applicable	Not Applicable

Valve Code	PSV-FB-1-C10K	PSV-FB-1-C10L	PSV-FB-1-C10M	PSV-FB-1-C10N
Specs	F10	F10	F10	F10
1. Valve Type	Conventional	Conventional	Conventional	Conventional
2. Orifice Size	Orifice K (1.838 in ²)	Orifice L (2.853 in ²)	Orifice M (3.60 in ²)	Orifice N (4.34 in ²)
3. Valve Specification Level (VSL)	VSL-1	VSL-1	VSL-1	VSL-1
4. Standard	API 520	API 520	API 520	API 520
5. Inlet/Outlet Size Range (NPS)	3" x 6"	4" x 6"	4" x 6"	4" x 6"
6. Inlet/Outlet end connection	ASME B16.5, RTJ x ASME B16.5, RF	ASME B16.5, RTJ x ASME B16.5, RF	ASME B16.5, RTJ x ASME B16.5, RF	ASME B16.5, RTJ x ASME B16.5, RF
7. Inlet/Outlet pressure class	900 x 150	900 x 150	900 x 150	900 x 150
8. Temperature	0°C to 240°C	0°C to 240°C	0°C to 240°C	0°C to 240°C
9. Material Class	Carbon Steel	Carbon Steel	Carbon Steel	Carbon Steel
10. Body and bonnet Material	ASTM A216 Gr WCB	ASTM A216 Gr WCB	ASTM A216 Gr WCB	ASTM A216 Gr WCB
11. Disc Material	Martensitic SS 400 Series	Martensitic SS 400 Series	Martensitic SS 400 Series	Martensitic SS 400 Series
12. Nozzle Material	AISI 316	AISI 316	AISI 316	AISI 316
13. Guide Material	AISI 316	AISI 316	AISI 316	AISI 316
14. Spindle Material	Martensitic SS 400 Series	Martensitic SS 400 Series	Martensitic SS 400 Series	Martensitic SS 400 Series
15. Spring Material	UNS N07750	UNS N07750	UNS N07750	UNS N07750
16. Bellow Material	Not applicable	Not applicable	Not applicable	Not applicable
17. Valve Testing	API 527	API 527	API 527	API 527
18. Notes	Not Applicable	Not Applicable	Not Applicable	Not Applicable

Valve Code	PSV-FB-1-C10P	PSV-FB-1-C11H	PSV-FB-1-C11J	PSV-FB-1-C11K
Specs	F10	F10	F10	F10
1. Valve Type	Conventional	Balanced	Balanced	Balanced
2. Orifice Size	Orifice P (6.38 in ²)	Orifice H (0.785 in ²)	Orifice J (1.287 in ²)	Orifice K (1.838 in ²)
3. Valve Specification Level (VSL)	VSL-1	VSL-1	VSL-1	VSL-1
4. Standard	API 520	API 520	API 520	API 520
5. Inlet/Outlet Size Range (NPS)	4" x 6"	2" x 3"	3" x 4"	3" x 6"
6. Inlet/Outlet end connection	ASME B16.5, RTJ x ASME B16.5, RF	ASME B16.5, RTJ x ASME B16.5, RF	ASME B16.5, RTJ x ASME B16.5, RF	ASME B16.5, RTJ x ASME B16.5, RF
7. Inlet/Outlet pressure class	900 x 150	900 x 150	900 x 150	900 x 150
8. Temperature	0°C to 240°C	0°C to 240°C	0°C to 240°C	0°C to 240°C
9. Material Class	Carbon Steel	Carbon Steel	Carbon Steel	Carbon Steel
10. Body and bonnet Material	ASTM A216 Gr WCB	ASTM A216 Gr WCB	ASTM A216 Gr WCB	ASTM A216 Gr WCB
11. Disc Material	Martensitic SS 400 Series	Martensitic SS 400 Series	Martensitic SS 400 Series	Martensitic SS 400 Series
12. Nozzle Material	AISI 316	AISI 316	AISI 316	AISI 316
13. Guide Material	AISI 316	AISI 316	AISI 316	AISI 316
14. Spindle Material	Martensitic SS 400 Series	Martensitic SS 400 Series	Martensitic SS 400 Series	Martensitic SS 400 Series
15. Spring Material	UNS N07750	UNS N07750	UNS N07750	UNS N07750
16. Bellow Material	Not applicable	UNS N06625	UNS N06625	UNS N06625
17. Valve Testing	API 527	API 527	API 527	API 527
18. Notes	Not Applicable	Not Applicable	Not Applicable	Not Applicable

Valve Code	PSV-FB-1-C11L	PSV-FB-1-C11M	PSV-FB-1-C11N	PSV-FB-1-C11P
Specs	F10	F10	F10	F10
1. Valve Type	Balanced	Balanced	Balanced	Balanced
2. Orifice Size	Orifice L (2.853 in ²)	Orifice M (3.60 in ²)	Orifice N (4.34 in ²)	Orifice P (6.38 in ²)
3. Valve Specification Level (VSL)	VSL-1	VSL-1	VSL-1	VSL-1
4. Standard	API 520	API 520	API 520	API 520
5. Inlet/Outlet Size Range (NPS)	4" x 6"	4" x 6"	4" x 6"	4" x 6"
6. Inlet/Outlet end connection	ASME B16.5, RTJ x ASME B16.5, RF	ASME B16.5, RTJ x ASME B16.5, RF	ASME B16.5, RTJ x ASME B16.5, RF	ASME B16.5, RTJ x ASME B16.5, RF
7. Inlet/Outlet pressure class	900 x 150	900 x 150	900 x 150	900 x 150
8. Temperature	0°C to 240°C	0°C to 240°C	0°C to 240°C	0°C to 240°C
9. Material Class	Carbon Steel	Carbon Steel	Carbon Steel	Carbon Steel
10. Body and bonnet Material	ASTM A216 Gr WCB	ASTM A216 Gr WCB	ASTM A216 Gr WCB	ASTM A216 Gr WCB
11. Disc Material	Martensitic SS 400 Series	Martensitic SS 400 Series	Martensitic SS 400 Series	Martensitic SS 400 Series
12. Nozzle Material	AISI 316	AISI 316	AISI 316	AISI 316
13. Guide Material	AISI 316	AISI 316	AISI 316	AISI 316
14. Spindle Material	Martensitic SS 400 Series	Martensitic SS 400 Series	Martensitic SS 400 Series	Martensitic SS 400 Series
15. Spring Material	UNS N07750	UNS N07750	UNS N07750	UNS N07750
16. Bellow Material	UNS N06625	UNS N06625	UNS N06625	UNS N06625
17. Valve Testing	API 527	API 527	API 527	API 527
18. Notes	Not Applicable	Not Applicable	Not Applicable	Not Applicable

Valve Code	PSV-FB-1-C20H	PSV-FB-1-C20J	PSV-FB-1-C20K	PSV-FB-1-C20L
Specs	F6 F10	F6 F10	F6 F10	F6 F10
1. Valve Type	Conventional	Conventional	Conventional	Conventional
2. Orifice Size	Orifice H (0.785 in ²)	Orifice J (1.287 in ²)	Orifice K (1.838 in ²)	Orifice L (2.853 in ²)
3. Valve Specification Level (VSL)	VSL-1	VSL-1	VSL-1	VSL-1
4. Standard	API 520	API 520	API 520	API 520
5. Inlet/Outlet Size Range (NPS)	2" x 3"	3" x 4"	3" x 6"	4" x 6"
6. Inlet/Outlet end connection	ASME B16.5, RTJ x ASME B16.5, RF	ASME B16.5, RTJ x ASME B16.5, RF	ASME B16.5, RTJ x ASME B16.5, RF	ASME B16.5, RTJ x ASME B16.5, RF
7. Inlet/Outlet pressure class	900 x 150	900 x 150	900 x 150	900 x 150
8. Temperature	-46°C to 240°C	-46°C to 240°C	-46°C to 240°C	-46°C to 240°C
9. Material Class	Carbon Steel	Carbon Steel	Carbon Steel	Carbon Steel
10. Body and bonnet Material	ASTM A352 Gr LCB	ASTM A352 Gr LCB	ASTM A352 Gr LCB	ASTM A352 Gr LCB
11. Disc Material	AISI 316 + Stellite	AISI 316 + Stellite	AISI 316 + Stellite	AISI 316 + Stellite
12. Nozzle Material	AISI 316	AISI 316	AISI 316	AISI 316
13. Guide Material	AISI 316	AISI 316	AISI 316	AISI 316
14. Spindle Material	Martensitic SS 400 Series	Martensitic SS 400 Series	Martensitic SS 400 Series	Martensitic SS 400 Series
15. Spring Material	UNS N07750	UNS N07750	UNS N07750	UNS N07750
16. Bellow Material	Not applicable	Not applicable	Not applicable	Not applicable
17. Valve Testing	API 527	API 527	API 527	API 527
18. Notes	Not Applicable	Not Applicable	Not Applicable	Not Applicable

Valve Code	PSV-FB-1-C20M	PSV-FB-1-C20N	PSV-FB-1-C20P	PSV-FB-1-C21H
Specs	F6 F10	F6 F10	F6 F10	F6 F10
1. Valve Type	Conventional	Conventional	Conventional	Balanced
2. Orifice Size	Orifice M (3.60 in ²)	Orifice N (4.34 in ²)	Orifice P (6.38 in ²)	Orifice H (0.785 in ²)
3. Valve Specification Level (VSL)	VSL-1	VSL-1	VSL-1	VSL-1
4. Standard	API 520	API 520	API 520	API 520
5. Inlet/Outlet Size Range (NPS)	4" x 6"	4" x 6"	4" x 6"	2" x 3"
6. Inlet/Outlet end connection	ASME B16.5, RTJ x ASME B16.5, RF	ASME B16.5, RTJ x ASME B16.5, RF	ASME B16.5, RTJ x ASME B16.5, RF	ASME B16.5, RTJ x ASME B16.5, RF
7. Inlet/Outlet pressure class	900 x 150	900 x 150	900 x 150	900 x 150
8. Temperature	-46°C to 240°C	-46°C to 240°C	-46°C to 240°C	-46°C to 240°C
9. Material Class	Carbon Steel	Carbon Steel	Carbon Steel	Carbon Steel
10. Body and bonnet Material	ASTM A352 Gr LCB	ASTM A352 Gr LCB	ASTM A352 Gr LCB	ASTM A352 Gr LCB
11. Disc Material	AISI 316 + Stellite	AISI 316 + Stellite	AISI 316 + Stellite	AISI 316 + Stellite
12. Nozzle Material	AISI 316	AISI 316	AISI 316	AISI 316
13. Guide Material	AISI 316	AISI 316	AISI 316	AISI 316
14. Spindle Material	Martensitic SS 400 Series	Martensitic SS 400 Series	Martensitic SS 400 Series	Martensitic SS 400 Series
15. Spring Material	UNS N07750	UNS N07750	UNS N07750	UNS N07750
16. Bellow Material	Not applicable	Not applicable	Not applicable	UNS N06625
17. Valve Testing	API 527	API 527	API 527	API 527
18. Notes	Not Applicable	Not Applicable	Not Applicable	Not Applicable

Valve Code	PSV-FB-1-C21J	PSV-FB-1-C21K	PSV-FB-1-C21L	PSV-FB-1-C21M
Specs	F6 F10	F6 F10	F6 F10	F6 F10
1. Valve Type	Balanced	Balanced	Balanced	Balanced
2. Orifice Size	Orifice J (1.287 in ²)	Orifice K (1.838 in ²)	Orifice L (2.853 in ²)	Orifice M (3.60 in ²)
3. Valve Specification Level (VSL)	VSL-1	VSL-1	VSL-1	VSL-1
4. Standard	API 520	API 520	API 520	API 520
5. Inlet/Outlet Size Range (NPS)	3" x 4"	3" x 6"	4" x 6"	4" x 6"
6. Inlet/Outlet end connection	ASME B16.5, RTJ x ASME B16.5, RF	ASME B16.5, RTJ x ASME B16.5, RF	ASME B16.5, RTJ x ASME B16.5, RF	ASME B16.5, RTJ x ASME B16.5, RF
7. Inlet/Outlet pressure class	900 x 150	900 x 150	900 x 150	900 x 150
8. Temperature	-46°C to 240°C	-46°C to 240°C	-46°C to 240°C	-46°C to 240°C
9. Material Class	Carbon Steel	Carbon Steel	Carbon Steel	Carbon Steel
10. Body and bonnet Material	ASTM A352 Gr LCB	ASTM A352 Gr LCB	ASTM A352 Gr LCB	ASTM A352 Gr LCB
11. Disc Material	AISI 316 + Stellite	AISI 316 + Stellite	AISI 316 + Stellite	AISI 316 + Stellite
12. Nozzle Material	AISI 316	AISI 316	AISI 316	AISI 316
13. Guide Material	AISI 316	AISI 316	AISI 316	AISI 316
14. Spindle Material	Martensitic SS 400 Series	Martensitic SS 400 Series	Martensitic SS 400 Series	Martensitic SS 400 Series
15. Spring Material	UNS N07750	UNS N07750	UNS N07750	UNS N07750
16. Bellow Material	UNS N06625	UNS N06625	UNS N06625	UNS N06625
17. Valve Testing	API 527	API 527	API 527	API 527
18. Notes	Not Applicable	Not Applicable	Not Applicable	Not Applicable

Valve Code	PSV-FB-1-C21N	PSV-FB-1-C21P	PSV-FB-1-S21H	PSV-FB-1-S21J
Specs	F6 F10	F6 F10	F3 F6 F10	F3 F6 F10
1. Valve Type	Balanced	Balanced	Balanced	Balanced
2. Orifice Size	Orifice N (4.34 in ²)	Orifice P (6.38 in ²)	Orifice H (0.785 in ²)	Orifice J (1.287 in ²)
3. Valve Specification Level (VSL)	VSL-1	VSL-1	VSL-1	VSL-1
4. Standard	API 520	API 520	API 520	API 520
5. Inlet/Outlet Size Range (NPS)	4" x 6"	4" x 6"	2" x 3"	3" x 4"
6. Inlet/Outlet end connection	ASME B16.5, RTJ x ASME B16.5, RF	ASME B16.5, RTJ x ASME B16.5, RF	ASME B16.5, RTJ x ASME B16.5, RF	ASME B16.5, RTJ x ASME B16.5, RF
7. Inlet/Outlet pressure class	900 x 150	900 x 150	900 x 150	900 x 150
8. Temperature	-46°C to 240°C	-46°C to 240°C	-100°C to 260°C	-100°C to 260°C
9. Material Class	Carbon Steel	Carbon Steel	Stainless Steel	Stainless Steel
10. Body and bonnet Material	ASTM A352 Gr LCB	ASTM A352 Gr LCB	ASTM A182 Gr CF8M	ASTM A182 Gr CF8M
11. Disc Material	AISI 316 + Stellite	AISI 316 + Stellite	AISI 316 + Stellite	AISI 316 + Stellite
12. Nozzle Material	AISI 316	AISI 316	AISI 316	AISI 316
13. Guide Material	AISI 316	AISI 316	AISI 316	AISI 316
14. Spindle Material	Martensitic SS 400 Series	Martensitic SS 400 Series	Martensitic SS 400 Series	Martensitic SS 400 Series
15. Spring Material	UNS N07750	UNS N07750	UNS N07750	UNS N07750
16. Bellow Material	UNS N06625	UNS N06625	UNS N06625	UNS N06625
17. Valve Testing	API 527	API 527	API 527	API 527
18. Notes	Not Applicable	Not Applicable	Not Applicable	Not Applicable

Valve Code	PSV-FB-1-S21K	PSV-FB-1-S21L	PSV-FB-1-S21M	PSV-FB-1-S21N
Specs	F3 F6 F10	F3 F6 F10	F3 F6 F10	F3 F6 F10
1. Valve Type	Balanced	Balanced	Balanced	Balanced
2. Orifice Size	Orifice K (1.838 in ²)	Orifice L (2.853 in ²)	Orifice M (3.60 in ²)	Orifice N (4.34 in ²)
3. Valve Specification Level (VSL)	VSL-1	VSL-1	VSL-1	VSL-1
4. Standard	API 520	API 520	API 520	API 520
5. Inlet/Outlet Size Range (NPS)	3" x 6"	4" x 6"	4" x 6"	4" x 6"
6. Inlet/Outlet end connection	ASME B16.5, RTJ x ASME B16.5, RF	ASME B16.5, RTJ x ASME B16.5, RF	ASME B16.5, RTJ x ASME B16.5, RF	ASME B16.5, RTJ x ASME B16.5, RF
7. Inlet/Outlet pressure class	900 x 150	900 x 150	900 x 150	900 x 150
8. Temperature	-100°C to 260°C	-100°C to 260°C	-100°C to 260°C	-100°C to 260°C
9. Material Class	Stainless Steel	Stainless Steel	Stainless Steel	Stainless Steel
10. Body and bonnet Material	ASTM A182 Gr CF8M	ASTM A182 Gr CF8M	ASTM A182 Gr CF8M	ASTM A182 Gr CF8M
11. Disc Material	AISI 316 + Stellite	AISI 316 + Stellite	AISI 316 + Stellite	AISI 316 + Stellite
12. Nozzle Material	AISI 316	AISI 316	AISI 316	AISI 316
13. Guide Material	AISI 316	AISI 316	AISI 316	AISI 316
14. Spindle Material	Martensitic SS 400 Series	Martensitic SS 400 Series	Martensitic SS 400 Series	Martensitic SS 400 Series
15. Spring Material	UNS N07750	UNS N07750	UNS N07750	UNS N07750
16. Bellow Material	UNS N06625	UNS N06625	UNS N06625	UNS N06625
17. Valve Testing	API 527	API 527	API 527	API 527
18. Notes	Not Applicable	Not Applicable	Not Applicable	Not Applicable

Valve Code	PSV-FB-1-S21P	PSV-FB-2-C10H	PSV-FB-2-C10J	PSV-FB-2-C10K
Specs	F3 F6 F10	F10	F10	F10
1. Valve Type	Balanced	Conventional	Conventional	Conventional
2. Orifice Size	Orifice P (6.38 in ²)	Orifice H (0.785 in ²)	Orifice J (1.287 in ²)	Orifice K (1.838 in ²)
3. Valve Specification Level (VSL)	VSL-1	VSL-2	VSL-2	VSL-2
4. Standard	API 520	API 520	API 520	API 520
5. Inlet/Outlet Size Range (NPS)	4" x 6"	2" x 3"	3" x 4"	3" x 6"
6. Inlet/Outlet end connection	ASME B16.5, RTJ x ASME B16.5, RF	ASME B16.5, RTJ x ASME B16.5, RF	ASME B16.5, RTJ x ASME B16.5, RF	ASME B16.5, RTJ x ASME B16.5, RF
7. Inlet/Outlet pressure class	900 x 150	900 x 150	900 x 150	900 x 150
8. Temperature	-100°C to 260°C	0°C to 240°C	0°C to 240°C	0°C to 240°C
9. Material Class	Stainless Steel	Carbon Steel	Carbon Steel	Carbon Steel
10. Body and bonnet Material	ASTM A182 Gr CF8M	ASTM A216 Gr WCB	ASTM A216 Gr WCB	ASTM A216 Gr WCB
11. Disc Material	AISI 316 + Stellite	Martensitic SS 400 Series	Martensitic SS 400 Series	Martensitic SS 400 Series
12. Nozzle Material	AISI 316	AISI 316	AISI 316	AISI 316
13. Guide Material	AISI 316	AISI 316	AISI 316	AISI 316
14. Spindle Material	Martensitic SS 400 Series	Martensitic SS 400 Series	Martensitic SS 400 Series	Martensitic SS 400 Series
15. Spring Material	UNS N07750	UNS N07750	UNS N07750	UNS N07750
16. Bellow Material	UNS N06625	Not applicable	Not applicable	Not applicable
17. Valve Testing	API 527	API 527	API 527	API 527
18. Notes	Not Applicable	Not Applicable	Not Applicable	Not Applicable

Valve Code	PSV-FB-2-C10L	PSV-FB-2-C10M	PSV-FB-2-C10N	PSV-FB-2-C10P
Specs	F10	F10	F10	F10
1. Valve Type	Conventional	Conventional	Conventional	Conventional
2. Orifice Size	Orifice L (2.853 in ²)	Orifice M (3.60 in ²)	Orifice N (4.34 in ²)	Orifice P (6.38 in ²)
3. Valve Specification Level (VSL)	VSL-2	VSL-2	VSL-2	VSL-2
4. Standard	API 520	API 520	API 520	API 520
5. Inlet/Outlet Size Range (NPS)	4" x 6"	4" x 6"	4" x 6"	4" x 6"
6. Inlet/Outlet end connection	ASME B16.5, RTJ x ASME B16.5, RF	ASME B16.5, RTJ x ASME B16.5, RF	ASME B16.5, RTJ x ASME B16.5, RF	ASME B16.5, RTJ x ASME B16.5, RF
7. Inlet/Outlet pressure class	900 x 150	900 x 150	900 x 150	900 x 150
8. Temperature	0°C to 240°C	0°C to 240°C	0°C to 240°C	0°C to 240°C
9. Material Class	Carbon Steel	Carbon Steel	Carbon Steel	Carbon Steel
10. Body and bonnet Material	ASTM A216 Gr WCB	ASTM A216 Gr WCB	ASTM A216 Gr WCB	ASTM A216 Gr WCB
11. Disc Material	Martensitic SS 400 Series	Martensitic SS 400 Series	Martensitic SS 400 Series	Martensitic SS 400 Series
12. Nozzle Material	AISI 316	AISI 316	AISI 316	AISI 316
13. Guide Material	AISI 316	AISI 316	AISI 316	AISI 316
14. Spindle Material	Martensitic SS 400 Series	Martensitic SS 400 Series	Martensitic SS 400 Series	Martensitic SS 400 Series
15. Spring Material	UNS N07750	UNS N07750	UNS N07750	UNS N07750
16. Bellow Material	Not applicable	Not applicable	Not applicable	Not applicable
17. Valve Testing	API 527	API 527	API 527	API 527
18. Notes	Not Applicable	Not Applicable	Not Applicable	Not Applicable

Valve Code	PSV-FB-2-C11H	PSV-FB-2-C11J	PSV-FB-2-C11K	PSV-FB-2-C11L
Specs	F10	F10	F10	F10
1. Valve Type	Balanced	Balanced	Balanced	Balanced
2. Orifice Size	Orifice H (0.785 in ²)	Orifice J (1.287 in ²)	Orifice K (1.838 in ²)	Orifice L (2.853 in ²)
3. Valve Specification Level (VSL)	VSL-2	VSL-2	VSL-2	VSL-2
4. Standard	API 520	API 520	API 520	API 520
5. Inlet/Outlet Size Range (NPS)	2" x 3"	3" x 4"	3" x 6"	4" x 6"
6. Inlet/Outlet end connection	ASME B16.5, RTJ x ASME B16.5, RF	ASME B16.5, RTJ x ASME B16.5, RF	ASME B16.5, RTJ x ASME B16.5, RF	ASME B16.5, RTJ x ASME B16.5, RF
7. Inlet/Outlet pressure class	900 x 150	900 x 150	900 x 150	900 x 150
8. Temperature	0°C to 240°C	0°C to 240°C	0°C to 240°C	0°C to 240°C
9. Material Class	Carbon Steel	Carbon Steel	Carbon Steel	Carbon Steel
10. Body and bonnet Material	ASTM A216 Gr WCB	ASTM A216 Gr WCB	ASTM A216 Gr WCB	ASTM A216 Gr WCB
11. Disc Material	Martensitic SS 400 Series	Martensitic SS 400 Series	Martensitic SS 400 Series	Martensitic SS 400 Series
12. Nozzle Material	AISI 316	AISI 316	AISI 316	AISI 316
13. Guide Material	AISI 316	AISI 316	AISI 316	AISI 316
14. Spindle Material	Martensitic SS 400 Series	Martensitic SS 400 Series	Martensitic SS 400 Series	Martensitic SS 400 Series
15. Spring Material	UNS N07750	UNS N07750	UNS N07750	UNS N07750
16. Bellow Material	UNS N06625	UNS N06625	UNS N06625	UNS N06625
17. Valve Testing	API 527	API 527	API 527	API 527
18. Notes	Not Applicable	Not Applicable	Not Applicable	Not Applicable

Valve Code	PSV-FB-2-C11M	PSV-FB-2-C11N	PSV-FB-2-C11P	PSV-FB-2-C20H
Specs	F10	F10	F10	F6 F10
1. Valve Type	Balanced	Balanced	Balanced	Conventional
2. Orifice Size	Orifice M (3.60 in ²)	Orifice N (4.34 in ²)	Orifice P (6.38 in ²)	Orifice H (0.785 in ²)
3. Valve Specification Level (VSL)	VSL-2	VSL-2	VSL-2	VSL-2
4. Standard	API 520	API 520	API 520	API 520
5. Inlet/Outlet Size Range (NPS)	4" x 6"	4" x 6"	4" x 6"	2" x 3"
6. Inlet/Outlet end connection	ASME B16.5, RTJ x ASME B16.5, RF	ASME B16.5, RTJ x ASME B16.5, RF	ASME B16.5, RTJ x ASME B16.5, RF	ASME B16.5, RTJ x ASME B16.5, RF
7. Inlet/Outlet pressure class	900 x 150	900 x 150	900 x 150	900 x 150
8. Temperature	0°C to 240°C	0°C to 240°C	0°C to 240°C	-46°C to 240°C
9. Material Class	Carbon Steel	Carbon Steel	Carbon Steel	Carbon Steel
10. Body and bonnet Material	ASTM A216 Gr WCB	ASTM A216 Gr WCB	ASTM A216 Gr WCB	ASTM A352 Gr LCB
11. Disc Material	Martensitic SS 400 Series	Martensitic SS 400 Series	Martensitic SS 400 Series	AISI 316 + Stellite
12. Nozzle Material	AISI 316	AISI 316	AISI 316	AISI 316
13. Guide Material	AISI 316	AISI 316	AISI 316	AISI 316
14. Spindle Material	Martensitic SS 400 Series	Martensitic SS 400 Series	Martensitic SS 400 Series	Martensitic SS 400 Series
15. Spring Material	UNS N07750	UNS N07750	UNS N07750	UNS N07750
16. Bellow Material	UNS N06625	UNS N06625	UNS N06625	Not applicable
17. Valve Testing	API 527	API 527	API 527	API 527
18. Notes	Not Applicable	Not Applicable	Not Applicable	Not Applicable

Valve Code	PSV-FB-2-C20J	PSV-FB-2-C20K	PSV-FB-2-C20L	PSV-FB-2-C20M
Specs	F6 F10	F6 F10	F6 F10	F6 F10
1. Valve Type	Conventional	Conventional	Conventional	Conventional
2. Orifice Size	Orifice J (1.287 in ²)	Orifice K (1.838 in ²)	Orifice L (2.853 in ²)	Orifice M (3.60 in ²)
3. Valve Specification Level (VSL)	VSL-2	VSL-2	VSL-2	VSL-2
4. Standard	API 520	API 520	API 520	API 520
5. Inlet/Outlet Size Range (NPS)	3" x 4"	3" x 6"	4" x 6"	4" x 6"
6. Inlet/Outlet end connection	ASME B16.5, RTJ x ASME B16.5, RF	ASME B16.5, RTJ x ASME B16.5, RF	ASME B16.5, RTJ x ASME B16.5, RF	ASME B16.5, RTJ x ASME B16.5, RF
7. Inlet/Outlet pressure class	900 x 150	900 x 150	900 x 150	900 x 150
8. Temperature	-46°C to 240°C	-46°C to 240°C	-46°C to 240°C	-46°C to 240°C
9. Material Class	Carbon Steel	Carbon Steel	Carbon Steel	Carbon Steel
10. Body and bonnet Material	ASTM A352 Gr LCB	ASTM A352 Gr LCB	ASTM A352 Gr LCB	ASTM A352 Gr LCB
11. Disc Material	AISI 316 + Stellite	AISI 316 + Stellite	AISI 316 + Stellite	AISI 316 + Stellite
12. Nozzle Material	AISI 316	AISI 316	AISI 316	AISI 316
13. Guide Material	AISI 316	AISI 316	AISI 316	AISI 316
14. Spindle Material	Martensitic SS 400 Series	Martensitic SS 400 Series	Martensitic SS 400 Series	Martensitic SS 400 Series
15. Spring Material	UNS N07750	UNS N07750	UNS N07750	UNS N07750
16. Bellow Material	Not applicable	Not applicable	Not applicable	Not applicable
17. Valve Testing	API 527	API 527	API 527	API 527
18. Notes	Not Applicable	Not Applicable	Not Applicable	Not Applicable

Valve Code	PSV-FB-2-C20N	PSV-FB-2-C20P	PSV-FB-2-C21H	PSV-FB-2-C21J
Specs	F6 F10	F6 F10	F6 F10	F6 F10
1. Valve Type	Conventional	Conventional	Balanced	Balanced
2. Orifice Size	Orifice N (4.34 in ²)	Orifice P (6.38 in ²)	Orifice H (0.785 in ²)	Orifice J (1.287 in ²)
3. Valve Specification Level (VSL)	VSL-2	VSL-2	VSL-2	VSL-2
4. Standard	API 520	API 520	API 520	API 520
5. Inlet/Outlet Size Range (NPS)	4" x 6"	4" x 6"	2" x 3"	3" x 4"
6. Inlet/Outlet end connection	ASME B16.5, RTJ x ASME B16.5, RF	ASME B16.5, RTJ x ASME B16.5, RF	ASME B16.5, RTJ x ASME B16.5, RF	ASME B16.5, RTJ x ASME B16.5, RF
7. Inlet/Outlet pressure class	900 x 150	900 x 150	900 x 150	900 x 150
8. Temperature	-46°C to 240°C	-46°C to 240°C	-46°C to 240°C	-46°C to 240°C
9. Material Class	Carbon Steel	Carbon Steel	Carbon Steel	Carbon Steel
10. Body and bonnet Material	ASTM A352 Gr LCB	ASTM A352 Gr LCB	ASTM A352 Gr LCB	ASTM A352 Gr LCB
11. Disc Material	AISI 316 + Stellite	AISI 316 + Stellite	AISI 316 + Stellite	AISI 316 + Stellite
12. Nozzle Material	AISI 316	AISI 316	AISI 316	AISI 316
13. Guide Material	AISI 316	AISI 316	AISI 316	AISI 316
14. Spindle Material	Martensitic SS 400 Series	Martensitic SS 400 Series	Martensitic SS 400 Series	Martensitic SS 400 Series
15. Spring Material	UNS N07750	UNS N07750	UNS N07750	UNS N07750
16. Bellow Material	Not applicable	Not applicable	UNS N06625	UNS N06625
17. Valve Testing	API 527	API 527	API 527	API 527
18. Notes	Not Applicable	Not Applicable	Not Applicable	Not Applicable

Valve Code	PSV-FB-2-C21K	PSV-FB-2-C21L	PSV-FB-2-C21M	PSV-FB-2-C21N
Specs	F6 F10	F6 F10	F6 F10	F6 F10
1. Valve Type	Balanced	Balanced	Balanced	Balanced
2. Orifice Size	Orifice K (1.838 in ²)	Orifice L (2.853 in ²)	Orifice M (3.60 in ²)	Orifice N (4.34 in ²)
3. Valve Specification Level (VSL)	VSL-2	VSL-2	VSL-2	VSL-2
4. Standard	API 520	API 520	API 520	API 520
5. Inlet/Outlet Size Range (NPS)	3" x 6"	4" x 6"	4" x 6"	4" x 6"
6. Inlet/Outlet end connection	ASME B16.5, RTJ x ASME B16.5, RF	ASME B16.5, RTJ x ASME B16.5, RF	ASME B16.5, RTJ x ASME B16.5, RF	ASME B16.5, RTJ x ASME B16.5, RF
7. Inlet/Outlet pressure class	900 x 150	900 x 150	900 x 150	900 x 150
8. Temperature	-46°C to 240°C	-46°C to 240°C	-46°C to 240°C	-46°C to 240°C
9. Material Class	Carbon Steel	Carbon Steel	Carbon Steel	Carbon Steel
10. Body and bonnet Material	ASTM A352 Gr LCB	ASTM A352 Gr LCB	ASTM A352 Gr LCB	ASTM A352 Gr LCB
11. Disc Material	AISI 316 + Stellite	AISI 316 + Stellite	AISI 316 + Stellite	AISI 316 + Stellite
12. Nozzle Material	AISI 316	AISI 316	AISI 316	AISI 316
13. Guide Material	AISI 316	AISI 316	AISI 316	AISI 316
14. Spindle Material	Martensitic SS 400 Series	Martensitic SS 400 Series	Martensitic SS 400 Series	Martensitic SS 400 Series
15. Spring Material	UNS N07750	UNS N07750	UNS N07750	UNS N07750
16. Bellow Material	UNS N06625	UNS N06625	UNS N06625	UNS N06625
17. Valve Testing	API 527	API 527	API 527	API 527
18. Notes	Not Applicable	Not Applicable	Not Applicable	Not Applicable

Valve Code	PSV-FB-2-C21P	PSV-FB-2-S21H	PSV-FB-2-S21J	PSV-FB-2-S21K
Specs	F6 F10	F3 F6 F10	F3 F6 F10	F3 F6 F10
1. Valve Type	Balanced	Balanced	Balanced	Balanced
2. Orifice Size	Orifice P (6.38 in ²)	Orifice H (0.785 in ²)	Orifice J (1.287 in ²)	Orifice K (1.838 in ²)
3. Valve Specification Level (VSL)	VSL-2	VSL-2	VSL-2	VSL-2
4. Standard	API 520	API 520	API 520	API 520
5. Inlet/Outlet Size Range (NPS)	4" x 6"	2" x 3"	3" x 4"	3" x 6"
6. Inlet/Outlet end connection	ASME B16.5, RTJ x ASME B16.5, RF	ASME B16.5, RTJ x ASME B16.5, RF	ASME B16.5, RTJ x ASME B16.5, RF	ASME B16.5, RTJ x ASME B16.5, RF
7. Inlet/Outlet pressure class	900 x 150	900 x 150	900 x 150	900 x 150
8. Temperature	-46°C to 240°C	-100°C to 260°C	-100°C to 260°C	-100°C to 260°C
9. Material Class	Carbon Steel	Stainless Steel	Stainless Steel	Stainless Steel
10. Body and bonnet Material	ASTM A352 Gr LCB	ASTM A182 Gr CF8M	ASTM A182 Gr CF8M	ASTM A182 Gr CF8M
11. Disc Material	AISI 316 + Stellite	AISI 316 + Stellite	AISI 316 + Stellite	AISI 316 + Stellite
12. Nozzle Material	AISI 316	AISI 316	AISI 316	AISI 316
13. Guide Material	AISI 316	AISI 316	AISI 316	AISI 316
14. Spindle Material	Martensitic SS 400 Series	Martensitic SS 400 Series	Martensitic SS 400 Series	Martensitic SS 400 Series
15. Spring Material	UNS N07750	UNS N07750	UNS N07750	UNS N07750
16. Bellow Material	UNS N06625	UNS N06625	UNS N06625	UNS N06625
17. Valve Testing	API 527	API 527	API 527	API 527
18. Notes	Not Applicable	Not Applicable	Not Applicable	Not Applicable

Valve Code	PSV-FB-2-S21L	PSV-FB-2-S21M	PSV-FB-2-S21N	PSV-FB-2-S21P
Specs	F3 F6 F10	F3 F6 F10	F3 F6 F10	F3 F6 F10
1. Valve Type	Balanced	Balanced	Balanced	Balanced
2. Orifice Size	Orifice L (2.853 in ²)	Orifice M (3.60 in ²)	Orifice N (4.34 in ²)	Orifice P (6.38 in ²)
3. Valve Specification Level (VSL)	VSL-2	VSL-2	VSL-2	VSL-2
4. Standard	API 520	API 520	API 520	API 520
5. Inlet/Outlet Size Range (NPS)	4" x 6"	4" x 6"	4" x 6"	4" x 6"
6. Inlet/Outlet end connection	ASME B16.5, RTJ x ASME B16.5, RF	ASME B16.5, RTJ x ASME B16.5, RF	ASME B16.5, RTJ x ASME B16.5, RF	ASME B16.5, RTJ x ASME B16.5, RF
7. Inlet/Outlet pressure class	900 x 150	900 x 150	900 x 150	900 x 150
8. Temperature	-100°C to 260°C	-100°C to 260°C	-100°C to 260°C	-100°C to 260°C
9. Material Class	Stainless Steel	Stainless Steel	Stainless Steel	Stainless Steel
10. Body and bonnet Material	ASTM A182 Gr CF8M	ASTM A182 Gr CF8M	ASTM A182 Gr CF8M	ASTM A182 Gr CF8M
11. Disc Material	AISI 316 + Stellite	AISI 316 + Stellite	AISI 316 + Stellite	AISI 316 + Stellite
12. Nozzle Material	AISI 316	AISI 316	AISI 316	AISI 316
13. Guide Material	AISI 316	AISI 316	AISI 316	AISI 316
14. Spindle Material	Martensitic SS 400 Series	Martensitic SS 400 Series	Martensitic SS 400 Series	Martensitic SS 400 Series
15. Spring Material	UNS N07750	UNS N07750	UNS N07750	UNS N07750
16. Bellow Material	UNS N06625	UNS N06625	UNS N06625	UNS N06625
17. Valve Testing	API 527	API 527	API 527	API 527
18. Notes	Not Applicable	Not Applicable	Not Applicable	Not Applicable

Valve Code	PSV-FC-1-C20D	PSV-FC-1-C20E	PSV-FC-1-C20F	PSV-FC-1-C20G
Specs	F6 F10	F6 F10	F6 F10	F6 F10
1. Valve Type	Conventional	Conventional	Conventional	Conventional
2. Orifice Size	Orifice D (A=0.110 in ²)	Orifice E (0.196 in ²)	Orifice F (0.307 in ²)	Orifice G (0.503 in ²)
3. Valve Specification Level (VSL)	VSL-1	VSL-1	VSL-1	VSL-1
4. Standard	API 520	API 520	API 520	API 520
5. Inlet/Outlet Size Range (NPS)	1 ½" x 2"	1 ½" x 2"	1 ½" x 3"	1 ½" x 3"
6. Inlet/Outlet end connection	ASME B16.5, RTJ x ASME B16.5, RF	ASME B16.5, RTJ x ASME B16.5, RF	ASME B16.5, RTJ x ASME B16.5, RF	ASME B16.5, RTJ x ASME B16.5, RF
7. Inlet/Outlet pressure class	900 x 300	900 x 300	900 x 300	900 x 300
8. Temperature	-46°C to 240°C	-46°C to 240°C	-46°C to 240°C	-46°C to 240°C
9. Material Class	Carbon Steel	Carbon Steel	Carbon Steel	Carbon Steel
10. Body and bonnet Material	ASTM A352 Gr LCB	ASTM A352 Gr LCB	ASTM A352 Gr LCB	ASTM A352 Gr LCB
11. Disc Material	AISI 316 + Stellite	AISI 316 + Stellite	AISI 316 + Stellite	AISI 316 + Stellite
12. Nozzle Material	AISI 316	AISI 316	AISI 316	AISI 316
13. Guide Material	AISI 316	AISI 316	AISI 316	AISI 316
14. Spindle Material	Martensitic SS 400 Series	Martensitic SS 400 Series	Martensitic SS 400 Series	Martensitic SS 400 Series
15. Spring Material	UNS N07750	UNS N07750	UNS N07750	UNS N07750
16. Bellow Material	Not applicable	Not applicable	Not applicable	Not applicable
17. Valve Testing	API 527	API 527	API 527	API 527
18. Notes	Not Applicable	Not Applicable	Not Applicable	Not Applicable

Valve Code	PSV-FC-1-C21D	PSV-FC-1-C21E	PSV-FC-1-C21F	PSV-FC-1-C21G
Specs	F6 F10	F6 F10	F6 F10	F6 F10
1. Valve Type	Balanced	Balanced	Balanced	Balanced
2. Orifice Size	Orifice D (A=0.110 in ²)	Orifice E (0.196 in ²)	Orifice F (0.307 in ²)	Orifice G (0.503 in ²)
3. Valve Specification Level (VSL)	VSL-1	VSL-1	VSL-1	VSL-1
4. Standard	API 520	API 520	API 520	API 520
5. Inlet/Outlet Size Range (NPS)	1 ½" x 2"	1 ½" x 2"	1 ½" x 3"	1 ½" x 3"
6. Inlet/Outlet end connection	ASME B16.5, RTJ x ASME B16.5, RF	ASME B16.5, RTJ x ASME B16.5, RF	ASME B16.5, RTJ x ASME B16.5, RF	ASME B16.5, RTJ x ASME B16.5, RF
7. Inlet/Outlet pressure class	900 x 300	900 x 300	900 x 300	900 x 300
8. Temperature	-46°C to 240°C	-46°C to 240°C	-46°C to 240°C	-46°C to 240°C
9. Material Class	Carbon Steel	Carbon Steel	Carbon Steel	Carbon Steel
10. Body and bonnet Material	ASTM A352 Gr LCB	ASTM A352 Gr LCB	ASTM A352 Gr LCB	ASTM A352 Gr LCB
11. Disc Material	AISI 316 + Stellite	AISI 316 + Stellite	AISI 316 + Stellite	AISI 316 + Stellite
12. Nozzle Material	AISI 316	AISI 316	AISI 316	AISI 316
13. Guide Material	AISI 316	AISI 316	AISI 316	AISI 316
14. Spindle Material	Martensitic SS 400 Series	Martensitic SS 400 Series	Martensitic SS 400 Series	Martensitic SS 400 Series
15. Spring Material	UNS N07750	UNS N07750	UNS N07750	UNS N07750
16. Bellow Material	UNS N06625	UNS N06625	UNS N06625	UNS N06625
17. Valve Testing	API 527	API 527	API 527	API 527
18. Notes	Not Applicable	Not Applicable	Not Applicable	Not Applicable

Valve Code	PSV-FC-1-S21D	PSV-FC-1-S21E	PSV-FC-1-S21F	PSV-FC-1-S21G
Specs	F3 F6 F10	F3 F6 F10	F3 F6 F10	F3 F6 F10
1. Valve Type	Balanced	Balanced	Balanced	Balanced
2. Orifice Size	Orifice D (A=0.110 in ²)	Orifice E (0.196 in ²)	Orifice F (0.307 in ²)	Orifice G (0.503 in ²)
3. Valve Specification Level (VSL)	VSL-1	VSL-1	VSL-1	VSL-1
4. Standard	API 520	API 520	API 520	API 520
5. Inlet/Outlet Size Range (NPS)	1 ½" x 2"	1 ½" x 2"	1 ½" x 3"	1 ½" x 3"
6. Inlet/Outlet end connection	ASME B16.5, RTJ x ASME B16.5, RF	ASME B16.5, RTJ x ASME B16.5, RF	ASME B16.5, RTJ x ASME B16.5, RF	ASME B16.5, RTJ x ASME B16.5, RF
7. Inlet/Outlet pressure class	900 x 300	900 x 300	900 x 300	900 x 300
8. Temperature	-100°C to 260°C	-100°C to 260°C	-100°C to 260°C	-100°C to 260°C
9. Material Class	Stainless Steel	Stainless Steel	Stainless Steel	Stainless Steel
10. Body and bonnet Material	ASTM A182 Gr CF8M	ASTM A182 Gr CF8M	ASTM A182 Gr CF8M	ASTM A182 Gr CF8M
11. Disc Material	AISI 316 + Stellite	AISI 316 + Stellite	AISI 316 + Stellite	AISI 316 + Stellite
12. Nozzle Material	AISI 316	AISI 316	AISI 316	AISI 316
13. Guide Material	AISI 316	AISI 316	AISI 316	AISI 316
14. Spindle Material	Martensitic SS 400 Series	Martensitic SS 400 Series	Martensitic SS 400 Series	Martensitic SS 400 Series
15. Spring Material	UNS N07750	UNS N07750	UNS N07750	UNS N07750
16. Bellow Material	UNS N06625	UNS N06625	UNS N06625	UNS N06625
17. Valve Testing	API 527	API 527	API 527	API 527
18. Notes	Not Applicable	Not Applicable	Not Applicable	Not Applicable

Valve Code	PSV-FC-2-C20D	PSV-FC-2-C20E	PSV-FC-2-C20F	PSV-FC-2-C20G
Specs	F6 F10	F6 F10	F6 F10	F6 F10
1. Valve Type	Conventional	Conventional	Conventional	Conventional
2. Orifice Size	Orifice D (A=0.110 in ²)	Orifice E (0.196 in ²)	Orifice F (0.307 in ²)	Orifice G (0.503 in ²)
3. Valve Specification Level (VSL)	VSL-2	VSL-2	VSL-2	VSL-2
4. Standard	API 520	API 520	API 520	API 520
5. Inlet/Outlet Size Range (NPS)	1 ½" x 2"	1 ½" x 2"	1 ½" x 3"	1 ½" x 3"
6. Inlet/Outlet end connection	ASME B16.5, RTJ x ASME B16.5, RF	ASME B16.5, RTJ x ASME B16.5, RF	ASME B16.5, RTJ x ASME B16.5, RF	ASME B16.5, RTJ x ASME B16.5, RF
7. Inlet/Outlet pressure class	900 x 300	900 x 300	900 x 300	900 x 300
8. Temperature	-46°C to 240°C	-46°C to 240°C	-46°C to 240°C	-46°C to 240°C
9. Material Class	Carbon Steel	Carbon Steel	Carbon Steel	Carbon Steel
10. Body and bonnet Material	ASTM A352 Gr LCB	ASTM A352 Gr LCB	ASTM A352 Gr LCB	ASTM A352 Gr LCB
11. Disc Material	AISI 316 + Stellite	AISI 316 + Stellite	AISI 316 + Stellite	AISI 316 + Stellite
12. Nozzle Material	AISI 316	AISI 316	AISI 316	AISI 316
13. Guide Material	AISI 316	AISI 316	AISI 316	AISI 316
14. Spindle Material	Martensitic SS 400 Series	Martensitic SS 400 Series	Martensitic SS 400 Series	Martensitic SS 400 Series
15. Spring Material	UNS N07750	UNS N07750	UNS N07750	UNS N07750
16. Bellow Material	Not applicable	Not applicable	Not applicable	Not applicable
17. Valve Testing	API 527	API 527	API 527	API 527
18. Notes	Not Applicable	Not Applicable	Not Applicable	Not Applicable

Valve Code	PSV-FC-2-C21D	PSV-FC-2-C21E	PSV-FC-2-C21F	PSV-FC-2-C21G
Specs	F6 F10	F6 F10	F6 F10	F6 F10
1. Valve Type	Balanced	Balanced	Balanced	Balanced
2. Orifice Size	Orifice D (A=0.110 in ²)	Orifice E (0.196 in ²)	Orifice F (0.307 in ²)	Orifice G (0.503 in ²)
3. Valve Specification Level (VSL)	VSL-2	VSL-2	VSL-2	VSL-2
4. Standard	API 520	API 520	API 520	API 520
5. Inlet/Outlet Size Range (NPS)	1 ½" x 2"	1 ½" x 2"	1 ½" x 3"	1 ½" x 3"
6. Inlet/Outlet end connection	ASME B16.5, RTJ x ASME B16.5, RF	ASME B16.5, RTJ x ASME B16.5, RF	ASME B16.5, RTJ x ASME B16.5, RF	ASME B16.5, RTJ x ASME B16.5, RF
7. Inlet/Outlet pressure class	900 x 300	900 x 300	900 x 300	900 x 300
8. Temperature	-46°C to 240°C	-46°C to 240°C	-46°C to 240°C	-46°C to 240°C
9. Material Class	Carbon Steel	Carbon Steel	Carbon Steel	Carbon Steel
10. Body and bonnet Material	ASTM A352 Gr LCB	ASTM A352 Gr LCB	ASTM A352 Gr LCB	ASTM A352 Gr LCB
11. Disc Material	AISI 316 + Stellite	AISI 316 + Stellite	AISI 316 + Stellite	AISI 316 + Stellite
12. Nozzle Material	AISI 316	AISI 316	AISI 316	AISI 316
13. Guide Material	AISI 316	AISI 316	AISI 316	AISI 316
14. Spindle Material	Martensitic SS 400 Series	Martensitic SS 400 Series	Martensitic SS 400 Series	Martensitic SS 400 Series
15. Spring Material	UNS N07750	UNS N07750	UNS N07750	UNS N07750
16. Bellow Material	UNS N06625	UNS N06625	UNS N06625	UNS N06625
17. Valve Testing	API 527	API 527	API 527	API 527
18. Notes	Not Applicable	Not Applicable	Not Applicable	Not Applicable

Valve Code	PSV-FC-2-S21D	PSV-FC-2-S21E	PSV-FC-2-S21F	PSV-FC-2-S21G
Specs	F3 F6 F10	F3 F6 F10	F3 F6 F10	F3 F6 F10
1. Valve Type	Balanced	Balanced	Balanced	Balanced
2. Orifice Size	Orifice D (A=0.110 in ²)	Orifice E (0.196 in ²)	Orifice F (0.307 in ²)	Orifice G (0.503 in ²)
3. Valve Specification Level (VSL)	VSL-2	VSL-2	VSL-2	VSL-2
4. Standard	API 520	API 520	API 520	API 520
5. Inlet/Outlet Size Range (NPS)	1 ½" x 2"	1 ½" x 2"	1 ½" x 3"	1 ½" x 3"
6. Inlet/Outlet end connection	ASME B16.5, RTJ x ASME B16.5, RF	ASME B16.5, RTJ x ASME B16.5, RF	ASME B16.5, RTJ x ASME B16.5, RF	ASME B16.5, RTJ x ASME B16.5, RF
7. Inlet/Outlet pressure class	900 x 300	900 x 300	900 x 300	900 x 300
8. Temperature	-100°C to 260°C	-100°C to 260°C	-100°C to 260°C	-100°C to 260°C
9. Material Class	Stainless Steel	Stainless Steel	Stainless Steel	Stainless Steel
10. Body and bonnet Material	ASTM A182 Gr CF8M	ASTM A182 Gr CF8M	ASTM A182 Gr CF8M	ASTM A182 Gr CF8M
11. Disc Material	AISI 316 + Stellite	AISI 316 + Stellite	AISI 316 + Stellite	AISI 316 + Stellite
12. Nozzle Material	AISI 316	AISI 316	AISI 316	AISI 316
13. Guide Material	AISI 316	AISI 316	AISI 316	AISI 316
14. Spindle Material	Martensitic SS 400 Series	Martensitic SS 400 Series	Martensitic SS 400 Series	Martensitic SS 400 Series
15. Spring Material	UNS N07750	UNS N07750	UNS N07750	UNS N07750
16. Bellow Material	UNS N06625	UNS N06625	UNS N06625	UNS N06625
17. Valve Testing	API 527	API 527	API 527	API 527
18. Notes	Not Applicable	Not Applicable	Not Applicable	Not Applicable

Valve Code	PSV-GB-2-C10L	PSV-GB-2-C11L	PSV-GB-2-C20L	PSV-GB-2-C21L
Specs	G10P	G10P	G10P	G10P
1. Valve Type	Conventional	Balanced	Conventional	Balanced
2. Orifice Size	Orifice L (2.853 in ²)	Orifice L (2.853 in ²)	Orifice L (2.853 in ²)	Orifice L (2.853 in ²)
3. Valve Specification Level (VSL)	VSL-2	VSL-2	VSL-2	VSL-2
4. Standard	API 520	API 520	API 520	API 520
5. Inlet/Outlet Size Range (NPS)	4" x 6"	4" x 6"	4" x 6"	4" x 6"
6. Inlet/Outlet end connection	ASME B16.5, RTJ x ASME B16.5, RF	ASME B16.5, RTJ x ASME B16.5, RF	ASME B16.5, RTJ x ASME B16.5, RF	ASME B16.5, RTJ x ASME B16.5, RF
7. Inlet/Outlet pressure class	1500 x 150	1500 x 150	1500 x 150	1500 x 150
8. Temperature	0°C to 240°C	0°C to 240°C	-46°C to 240°C	-46°C to 240°C
9. Material Class	Carbon Steel	Carbon Steel	Carbon Steel	Carbon Steel
10. Body and bonnet Material	ASTM A216 Gr WCB	ASTM A216 Gr WCB	ASTM A352 Gr LCB	ASTM A352 Gr LCB
11. Disc Material	Martensitic SS 400 Series	Martensitic SS 400 Series	AISI 316 + Stellite	AISI 316 + Stellite
12. Nozzle Material	AISI 316	AISI 316	AISI 316	AISI 316
13. Guide Material	AISI 316	AISI 316	AISI 316	AISI 316
14. Spindle Material	Martensitic SS 400 Series	Martensitic SS 400 Series	Martensitic SS 400 Series	Martensitic SS 400 Series
15. Spring Material	UNS N07750	UNS N07750	UNS N07750	UNS N07750
16. Bellow Material	Not applicable	UNS N06625	Not applicable	UNS N06625
17. Valve Testing	API 527	API 527	API 527	API 527
18. Notes	Not Applicable	Not Applicable	Not Applicable	Not Applicable

Valve Code	PSV-GB-2-S21L	PSV-GC-2-C10E	PSV-GC-2-C10F	PSV-GC-2-C10G
Specs	G3 G10P	G10P	G10P	G10P
1. Valve Type	Balanced	Conventional	Conventional	Conventional
2. Orifice Size	Orifice L (2.853 in ²)	Orifice E (0.196 in ²)	Orifice F (0.307 in ²)	Orifice G (0.503 in ²)
3. Valve Specification Level (VSL)	VSL-2	VSL-2	VSL-2	VSL-2
4. Standard	API 520	API 520	API 520	API 520
5. Inlet/Outlet Size Range (NPS)	4" x 6"	1 ½" x 2"	1 ½" x 3"	2" x 3"
6. Inlet/Outlet end connection	ASME B16.5, RTJ x ASME B16.5, RF	ASME B16.5, RTJ x ASME B16.5, RF	ASME B16.5, RTJ x ASME B16.5, RF	ASME B16.5, RTJ x ASME B16.5, RF
7. Inlet/Outlet pressure class	1500 x 150	1500 x 300	1500 x 300	1500 x 300
8. Temperature	-100°C to 260°C	0°C to 240°C	0°C to 240°C	0°C to 240°C
9. Material Class	Stainless Steel	Carbon Steel	Carbon Steel	Carbon Steel
10. Body and bonnet Material	ASTM A182 Gr CF8M	ASTM A216 Gr WCB	ASTM A216 Gr WCB	ASTM A216 Gr WCB
11. Disc Material	AISI 316 + Stellite	Martensitic SS 400 Series	Martensitic SS 400 Series	Martensitic SS 400 Series
12. Nozzle Material	AISI 316	AISI 316	AISI 316	AISI 316
13. Guide Material	AISI 316	AISI 316	AISI 316	AISI 316
14. Spindle Material	Martensitic SS 400 Series	Martensitic SS 400 Series	Martensitic SS 400 Series	Martensitic SS 400 Series
15. Spring Material	UNS N07750	UNS N07750	UNS N07750	UNS N07750
16. Bellow Material	UNS N06625	Not applicable	Not applicable	Not applicable
17. Valve Testing	API 527	API 527	API 527	API 527
18. Notes	Not Applicable	Not Applicable	Not Applicable	Not Applicable

Valve Code	PSV-GC-2-C10H	PSV-GC-2-C10J	PSV-GC-2-C10K	PSV-GC-2-C11D
Specs	G10P	G10P	G10P	G10P
1. Valve Type	Conventional	Conventional	Conventional	Balanced
2. Orifice Size	Orifice H (0.785 in ²)	Orifice J (1.287 in ²)	Orifice K (1.838 in ²)	Orifice D (A=0.110 in ²)
3. Valve Specification Level (VSL)	VSL-2	VSL-2	VSL-2	VSL-2
4. Standard	API 520	API 520	API 520	API 520
5. Inlet/Outlet Size Range (NPS)	2" x 3"	3" x 4"	3" x 6"	1 ½" x 2"
6. Inlet/Outlet end connection	ASME B16.5, RTJ x ASME B16.5, RF	ASME B16.5, RTJ x ASME B16.5, RF	ASME B16.5, RTJ x ASME B16.5, RF	ASME B16.5, RTJ x ASME B16.5, RF
7. Inlet/Outlet pressure class	1500 x 300	1500 x 300	1500 x 300	1500 x 300
8. Temperature	0°C to 240°C	0°C to 240°C	0°C to 240°C	0°C to 240°C
9. Material Class	Carbon Steel	Carbon Steel	Carbon Steel	Carbon Steel
10. Body and bonnet Material	ASTM A216 Gr WCB	ASTM A216 Gr WCB	ASTM A216 Gr WCB	ASTM A216 Gr WCB
11. Disc Material	Martensitic SS 400 Series	Martensitic SS 400 Series	Martensitic SS 400 Series	Martensitic SS 400 Series
12. Nozzle Material	AISI 316	AISI 316	AISI 316	AISI 316
13. Guide Material	AISI 316	AISI 316	AISI 316	AISI 316
14. Spindle Material	Martensitic SS 400 Series	Martensitic SS 400 Series	Martensitic SS 400 Series	Martensitic SS 400 Series
15. Spring Material	UNS N07750	UNS N07750	UNS N07750	UNS N07750
16. Bellow Material	Not applicable	Not applicable	Not applicable	UNS N06625
17. Valve Testing	API 527	API 527	API 527	API 527
18. Notes	Not Applicable	Not Applicable	Not Applicable	Not Applicable

Valve Code	PSV-GC-2-C11E	PSV-GC-2-C11F	PSV-GC-2-C11G	PSV-GC-2-C11H
Specs	G10P	G10P	G10P	G10P
1. Valve Type	Balanced	Balanced	Balanced	Balanced
2. Orifice Size	Orifice E (0.196 in ²)	Orifice F (0.307 in ²)	Orifice G (0.503 in ²)	Orifice H (0.785 in ²)
3. Valve Specification Level (VSL)	VSL-2	VSL-2	VSL-2	VSL-2
4. Standard	API 520	API 520	API 520	API 520
5. Inlet/Outlet Size Range (NPS)	1 ½" x 2"	1 ½" x 3"	2" x 3"	2" x 3"
6. Inlet/Outlet end connection	ASME B16.5, RTJ x ASME B16.5, RF	ASME B16.5, RTJ x ASME B16.5, RF	ASME B16.5, RTJ x ASME B16.5, RF	ASME B16.5, RTJ x ASME B16.5, RF
7. Inlet/Outlet pressure class	1500 x 300	1500 x 300	1500 x 300	1500 x 300
8. Temperature	0°C to 240°C	0°C to 240°C	0°C to 240°C	0°C to 240°C
9. Material Class	Carbon Steel	Carbon Steel	Carbon Steel	Carbon Steel
10. Body and bonnet Material	ASTM A216 Gr WCB	ASTM A216 Gr WCB	ASTM A216 Gr WCB	ASTM A216 Gr WCB
11. Disc Material	Martensitic SS 400 Series	Martensitic SS 400 Series	Martensitic SS 400 Series	Martensitic SS 400 Series
12. Nozzle Material	AISI 316	AISI 316	AISI 316	AISI 316
13. Guide Material	AISI 316	AISI 316	AISI 316	AISI 316
14. Spindle Material	Martensitic SS 400 Series	Martensitic SS 400 Series	Martensitic SS 400 Series	Martensitic SS 400 Series
15. Spring Material	UNS N07750	UNS N07750	UNS N07750	UNS N07750
16. Bellow Material	UNS N06625	UNS N06625	UNS N06625	UNS N06625
17. Valve Testing	API 527	API 527	API 527	API 527
18. Notes	Not Applicable	Not Applicable	Not Applicable	Not Applicable

Valve Code	PSV-GC-2-C11J	PSV-GC-2-C11K	PSV-GC-2-C20D	PSV-GC-2-C20E
Specs	G10P	G10P	G10P	G10P
1. Valve Type	Balanced	Balanced	Conventional	Conventional
2. Orifice Size	Orifice J (1.287 in ²)	Orifice K (1.838 in ²)	Orifice D (A=0.110 in ²)	Orifice E (0.196 in ²)
3. Valve Specification Level (VSL)	VSL-2	VSL-2	VSL-2	VSL-2
4. Standard	API 520	API 520	API 520	API 520
5. Inlet/Outlet Size Range (NPS)	3" x 4"	3" x 6"	1 ½" x 2"	1 ½" x 2"
6. Inlet/Outlet end connection	ASME B16.5, RTJ x ASME B16.5, RF	ASME B16.5, RTJ x ASME B16.5, RF	ASME B16.5, RTJ x ASME B16.5, RF	ASME B16.5, RTJ x ASME B16.5, RF
7. Inlet/Outlet pressure class	1500 x 300	1500 x 300	1500 x 300	1500 x 300
8. Temperature	0°C to 240°C	0°C to 240°C	-46°C to 240°C	-46°C to 240°C
9. Material Class	Carbon Steel	Carbon Steel	Carbon Steel	Carbon Steel
10. Body and bonnet Material	ASTM A216 Gr WCB	ASTM A216 Gr WCB	ASTM A352 Gr LCB	ASTM A352 Gr LCB
11. Disc Material	Martensitic SS 400 Series	Martensitic SS 400 Series	AISI 316 + Stellite	AISI 316 + Stellite
12. Nozzle Material	AISI 316	AISI 316	AISI 316	AISI 316
13. Guide Material	AISI 316	AISI 316	AISI 316	AISI 316
14. Spindle Material	Martensitic SS 400 Series	Martensitic SS 400 Series	Martensitic SS 400 Series	Martensitic SS 400 Series
15. Spring Material	UNS N07750	UNS N07750	UNS N07750	UNS N07750
16. Bellow Material	UNS N06625	UNS N06625	Not applicable	Not applicable
17. Valve Testing	API 527	API 527	API 527	API 527
18. Notes	Not Applicable	Not Applicable	Not Applicable	Not Applicable

Valve Code	PSV-GC-2-C20F	PSV-GC-2-C20G	PSV-GC-2-C20H	PSV-GC-2-C20J
Specs	G10P	G10P	G10P	G10P
1. Valve Type	Conventional	Conventional	Conventional	Conventional
2. Orifice Size	Orifice F (0.307 in ²)	Orifice G (0.503 in ²)	Orifice H (0.785 in ²)	Orifice J (1.287 in ²)
3. Valve Specification Level (VSL)	VSL-2	VSL-2	VSL-2	VSL-2
4. Standard	API 520	API 520	API 520	API 520
5. Inlet/Outlet Size Range (NPS)	1 ½" x 3"	2" x 3"	2" x 3"	3" x 4"
6. Inlet/Outlet end connection	ASME B16.5, RTJ x ASME B16.5, RF	ASME B16.5, RTJ x ASME B16.5, RF	ASME B16.5, RTJ x ASME B16.5, RF	ASME B16.5, RTJ x ASME B16.5, RF
7. Inlet/Outlet pressure class	1500 x 300	1500 x 300	1500 x 300	1500 x 300
8. Temperature	-46°C to 240°C	-46°C to 240°C	-46°C to 240°C	-46°C to 240°C
9. Material Class	Carbon Steel	Carbon Steel	Carbon Steel	Carbon Steel
10. Body and bonnet Material	ASTM A352 Gr LCB	ASTM A352 Gr LCB	ASTM A352 Gr LCB	ASTM A352 Gr LCB
11. Disc Material	AISI 316 + Stellite	AISI 316 + Stellite	AISI 316 + Stellite	AISI 316 + Stellite
12. Nozzle Material	AISI 316	AISI 316	AISI 316	AISI 316
13. Guide Material	AISI 316	AISI 316	AISI 316	AISI 316
14. Spindle Material	Martensitic SS 400 Series	Martensitic SS 400 Series	Martensitic SS 400 Series	Martensitic SS 400 Series
15. Spring Material	UNS N07750	UNS N07750	UNS N07750	UNS N07750
16. Bellow Material	Not applicable	Not applicable	Not applicable	Not applicable
17. Valve Testing	API 527	API 527	API 527	API 527
18. Notes	Not Applicable	Not Applicable	Not Applicable	Not Applicable

Valve Code	PSV-GC-2-C20K	PSV-GC-2-C21D	PSV-GC-2-C21E	PSV-GC-2-C21F
Specs	G10P	G10P	G10P	G10P
1. Valve Type	Conventional	Balanced	Balanced	Balanced
2. Orifice Size	Orifice K (1.838 in ²)	Orifice D (A=0.110 in ²)	Orifice E (0.196 in ²)	Orifice F (0.307 in ²)
3. Valve Specification Level (VSL)	VSL-2	VSL-2	VSL-2	VSL-2
4. Standard	API 520	API 520	API 520	API 520
5. Inlet/Outlet Size Range (NPS)	3" x 6"	1 ½" x 2"	1 ½" x 2"	1 ½" x 3"
6. Inlet/Outlet end connection	ASME B16.5, RTJ x ASME B16.5, RF	ASME B16.5, RTJ x ASME B16.5, RF	ASME B16.5, RTJ x ASME B16.5, RF	ASME B16.5, RTJ x ASME B16.5, RF
7. Inlet/Outlet pressure class	1500 x 300	1500 x 300	1500 x 300	1500 x 300
8. Temperature	-46°C to 240°C	-46°C to 240°C	-46°C to 240°C	-46°C to 240°C
9. Material Class	Carbon Steel	Carbon Steel	Carbon Steel	Carbon Steel
10. Body and bonnet Material	ASTM A352 Gr LCB	ASTM A352 Gr LCB	ASTM A352 Gr LCB	ASTM A352 Gr LCB
11. Disc Material	AISI 316 + Stellite	AISI 316 + Stellite	AISI 316 + Stellite	AISI 316 + Stellite
12. Nozzle Material	AISI 316	AISI 316	AISI 316	AISI 316
13. Guide Material	AISI 316	AISI 316	AISI 316	AISI 316
14. Spindle Material	Martensitic SS 400 Series	Martensitic SS 400 Series	Martensitic SS 400 Series	Martensitic SS 400 Series
15. Spring Material	UNS N07750	UNS N07750	UNS N07750	UNS N07750
16. Bellow Material	Not applicable	UNS N06625	UNS N06625	UNS N06625
17. Valve Testing	API 527	API 527	API 527	API 527
18. Notes	Not Applicable	Not Applicable	Not Applicable	Not Applicable

Valve Code	PSV-GC-2-C21G	PSV-GC-2-C21H	PSV-GC-2-C21J	PSV-GC-2-C21K
Specs	G10P	G10P	G10P	G10P
1. Valve Type	Balanced	Balanced	Balanced	Balanced
2. Orifice Size	Orifice G (0.503 in ²)	Orifice H (0.785 in ²)	Orifice J (1.287 in ²)	Orifice K (1.838 in ²)
3. Valve Specification Level (VSL)	VSL-2	VSL-2	VSL-2	VSL-2
4. Standard	API 520	API 520	API 520	API 520
5. Inlet/Outlet Size Range (NPS)	2" x 3"	2" x 3"	3" x 4"	3" x 6"
6. Inlet/Outlet end connection	ASME B16.5, RTJ x ASME B16.5, RF	ASME B16.5, RTJ x ASME B16.5, RF	ASME B16.5, RTJ x ASME B16.5, RF	ASME B16.5, RTJ x ASME B16.5, RF
7. Inlet/Outlet pressure class	1500 x 300	1500 x 300	1500 x 300	1500 x 300
8. Temperature	-46°C to 240°C	-46°C to 240°C	-46°C to 240°C	-46°C to 240°C
9. Material Class	Carbon Steel	Carbon Steel	Carbon Steel	Carbon Steel
10. Body and bonnet Material	ASTM A352 Gr LCB	ASTM A352 Gr LCB	ASTM A352 Gr LCB	ASTM A352 Gr LCB
11. Disc Material	AISI 316 + Stellite	AISI 316 + Stellite	AISI 316 + Stellite	AISI 316 + Stellite
12. Nozzle Material	AISI 316	AISI 316	AISI 316	AISI 316
13. Guide Material	AISI 316	AISI 316	AISI 316	AISI 316
14. Spindle Material	Martensitic SS 400 Series	Martensitic SS 400 Series	Martensitic SS 400 Series	Martensitic SS 400 Series
15. Spring Material	UNS N07750	UNS N07750	UNS N07750	UNS N07750
16. Bellow Material	UNS N06625	UNS N06625	UNS N06625	UNS N06625
17. Valve Testing	API 527	API 527	API 527	API 527
18. Notes	Not Applicable	Not Applicable	Not Applicable	Not Applicable

Valve Code	PSV-GC-2-S21D	PSV-GC-2-S21E	PSV-GC-2-S21F	PSV-GC-2-S21G
Specs	G3 G10P	G3 G10P	G3 G10P	G3 G10P
1. Valve Type	Balanced	Balanced	Balanced	Balanced
2. Orifice Size	Orifice D (A=0.110 in ²)	Orifice E (0.196 in ²)	Orifice F (0.307 in ²)	Orifice G (0.503 in ²)
3. Valve Specification Level (VSL)	VSL-2	VSL-2	VSL-2	VSL-2
4. Standard	API 520	API 520	API 520	API 520
5. Inlet/Outlet Size Range (NPS)	1 ½" x 2"	1 ½" x 2"	1 ½" x 3"	2" x 3"
6. Inlet/Outlet end connection	ASME B16.5, RTJ x ASME B16.5, RF	ASME B16.5, RTJ x ASME B16.5, RF	ASME B16.5, RTJ x ASME B16.5, RF	ASME B16.5, RTJ x ASME B16.5, RF
7. Inlet/Outlet pressure class	1500 x 300	1500 x 300	1500 x 300	1500 x 300
8. Temperature	-100°C to 260°C	-100°C to 260°C	-100°C to 260°C	-100°C to 260°C
9. Material Class	Stainless Steel	Stainless Steel	Stainless Steel	Stainless Steel
10. Body and bonnet Material	ASTM A182 Gr CF8M	ASTM A182 Gr CF8M	ASTM A182 Gr CF8M	ASTM A182 Gr CF8M
11. Disc Material	AISI 316 + Stellite	AISI 316 + Stellite	AISI 316 + Stellite	AISI 316 + Stellite
12. Nozzle Material	AISI 316	AISI 316	AISI 316	AISI 316
13. Guide Material	AISI 316	AISI 316	AISI 316	AISI 316
14. Spindle Material	Martensitic SS 400 Series	Martensitic SS 400 Series	Martensitic SS 400 Series	Martensitic SS 400 Series
15. Spring Material	UNS N07750	UNS N07750	UNS N07750	UNS N07750
16. Bellow Material	UNS N06625	UNS N06625	UNS N06625	UNS N06625
17. Valve Testing	API 527	API 527	API 527	API 527
18. Notes	Not Applicable	Not Applicable	Not Applicable	Not Applicable

Valve Code	PSV-GC-2-S21H	PSV-GC-2-S21J	PSV-GC-2-S21K	PSV-HC-2-C10D
Specs	G3 G10P	G3 G10P	G3 G10P	H10
1. Valve Type	Balanced	Balanced	Balanced	Conventional
2. Orifice Size	Orifice H (0.785 in ²)	Orifice J (1.287 in ²)	Orifice K (1.838 in ²)	Orifice D (A=0.110 in ²)
3. Valve Specification Level (VSL)	VSL-2	VSL-2	VSL-2	VSL-2
4. Standard	API 520	API 520	API 520	API 520
5. Inlet/Outlet Size Range (NPS)	2" x 3"	3" x 4"	3" x 6"	1 ½" x 3"
6. Inlet/Outlet end connection	ASME B16.5, RTJ x ASME B16.5, RF	ASME B16.5, RTJ x ASME B16.5, RF	ASME B16.5, RTJ x ASME B16.5, RF	ASME B16.5, RTJ x ASME B16.5, RF
7. Inlet/Outlet pressure class	1500 x 300	1500 x 300	1500 x 300	2500 x 300
8. Temperature	-100°C to 260°C	-100°C to 260°C	-100°C to 260°C	0°C to 240°C
9. Material Class	Stainless Steel	Stainless Steel	Stainless Steel	Carbon Steel
10. Body and bonnet Material	ASTM A182 Gr CF8M	ASTM A182 Gr CF8M	ASTM A182 Gr CF8M	ASTM A216 Gr WCB
11. Disc Material	AISI 316 + Stellite	AISI 316 + Stellite	AISI 316 + Stellite	Martensitic SS 400 Series
12. Nozzle Material	AISI 316	AISI 316	AISI 316	AISI 316
13. Guide Material	AISI 316	AISI 316	AISI 316	AISI 316
14. Spindle Material	Martensitic SS 400 Series	Martensitic SS 400 Series	Martensitic SS 400 Series	Martensitic SS 400 Series
15. Spring Material	UNS N07750	UNS N07750	UNS N07750	UNS N07750
16. Bellow Material	UNS N06625	UNS N06625	UNS N06625	Not applicable
17. Valve Testing	API 527	API 527	API 527	API 527
18. Notes	Not Applicable	Not Applicable	Not Applicable	Not Applicable

Valve Code	PSV-HC-2-C10E	PSV-HC-2-C10F	PSV-HC-2-C10G	PSV-HC-2-C11D
Specs	H10	H10	H10	H10
1. Valve Type	Conventional	Conventional	Conventional	Balanced
2. Orifice Size	Orifice E (0.196 in ²)	Orifice F (0.307 in ²)	Orifice G (0.503 in ²)	Orifice D (A=0.110 in ²)
3. Valve Specification Level (VSL)	VSL-2	VSL-2	VSL-2	VSL-2
4. Standard	API 520	API 520	API 520	API 520
5. Inlet/Outlet Size Range (NPS)	1 ½" x 3"	1 ½" x 3"	2" x 3"	1 ½" x 3"
6. Inlet/Outlet end connection	ASME B16.5, RTJ x ASME B16.5, RF	ASME B16.5, RTJ x ASME B16.5, RF	ASME B16.5, RTJ x ASME B16.5, RF	ASME B16.5, RTJ x ASME B16.5, RF
7. Inlet/Outlet pressure class	2500 x 300	2500 x 300	2500 x 300	2500 x 300
8. Temperature	0°C to 240°C	0°C to 240°C	0°C to 240°C	0°C to 240°C
9. Material Class	Carbon Steel	Carbon Steel	Carbon Steel	Carbon Steel
10. Body and bonnet Material	ASTM A216 Gr WCB	ASTM A216 Gr WCB	ASTM A216 Gr WCB	ASTM A216 Gr WCB
11. Disc Material	Martensitic SS 400 Series	Martensitic SS 400 Series	Martensitic SS 400 Series	Martensitic SS 400 Series
12. Nozzle Material	AISI 316	AISI 316	AISI 316	AISI 316
13. Guide Material	AISI 316	AISI 316	AISI 316	AISI 316
14. Spindle Material	Martensitic SS 400 Series	Martensitic SS 400 Series	Martensitic SS 400 Series	Martensitic SS 400 Series
15. Spring Material	UNS N07750	UNS N07750	UNS N07750	UNS N07750
16. Bellow Material	Not applicable	Not applicable	Not applicable	UNS N06625
17. Valve Testing	API 527	API 527	API 527	API 527
18. Notes	Not Applicable	Not Applicable	Not Applicable	Not Applicable

Valve Code	PSV-HC-2-C11E	PSV-HC-2-C11F	PSV-HC-2-C11G	PSV-HC-2-C20D
Specs	H10	H10	H10	H6 H10
1. Valve Type	Balanced	Balanced	Balanced	Conventional
2. Orifice Size	Orifice E (0.196 in ²)	Orifice F (0.307 in ²)	Orifice G (0.503 in ²)	Orifice D (A=0.110 in ²)
3. Valve Specification Level (VSL)	VSL-2	VSL-2	VSL-2	VSL-2
4. Standard	API 520	API 520	API 520	API 520
5. Inlet/Outlet Size Range (NPS)	1 ½" x 3"	1 ½" x 3"	2" x 3"	1 ½" x 3"
6. Inlet/Outlet end connection	ASME B16.5, RTJ x ASME B16.5, RF	ASME B16.5, RTJ x ASME B16.5, RF	ASME B16.5, RTJ x ASME B16.5, RF	ASME B16.5, RTJ x ASME B16.5, RF
7. Inlet/Outlet pressure class	2500 x 300	2500 x 300	2500 x 300	2500 x 300
8. Temperature	0°C to 240°C	0°C to 240°C	0°C to 240°C	-46°C to 240°C
9. Material Class	Carbon Steel	Carbon Steel	Carbon Steel	Carbon Steel
10. Body and bonnet Material	ASTM A216 Gr WCB	ASTM A216 Gr WCB	ASTM A216 Gr WCB	ASTM A352 Gr LCB
11. Disc Material	Martensitic SS 400 Series	Martensitic SS 400 Series	Martensitic SS 400 Series	AISI 316 + Stellite
12. Nozzle Material	AISI 316	AISI 316	AISI 316	AISI 316
13. Guide Material	AISI 316	AISI 316	AISI 316	AISI 316
14. Spindle Material	Martensitic SS 400 Series	Martensitic SS 400 Series	Martensitic SS 400 Series	Martensitic SS 400 Series
15. Spring Material	UNS N07750	UNS N07750	UNS N07750	UNS N07750
16. Bellow Material	UNS N06625	UNS N06625	UNS N06625	Not applicable
17. Valve Testing	API 527	API 527	API 527	API 527
18. Notes	Not Applicable	Not Applicable	Not Applicable	Not Applicable

Valve Code	PSV-HC-2-C20E	PSV-HC-2-C20F	PSV-HC-2-C20G	PSV-HC-2-C21D
Specs	H6 H10	H6 H10	H6 H10	H6 H10
1. Valve Type	Conventional	Conventional	Conventional	Balanced
2. Orifice Size	Orifice E (0.196 in ²)	Orifice F (0.307 in ²)	Orifice G (0.503 in ²)	Orifice D (A=0.110 in ²)
3. Valve Specification Level (VSL)	VSL-2	VSL-2	VSL-2	VSL-2
4. Standard	API 520	API 520	API 520	API 520
5. Inlet/Outlet Size Range (NPS)	1 ½" x 3"	1 ½" x 3"	2" x 3"	1 ½" x 3"
6. Inlet/Outlet end connection	ASME B16.5, RTJ x ASME B16.5, RF	ASME B16.5, RTJ x ASME B16.5, RF	ASME B16.5, RTJ x ASME B16.5, RF	ASME B16.5, RTJ x ASME B16.5, RF
7. Inlet/Outlet pressure class	2500 x 300	2500 x 300	2500 x 300	2500 x 300
8. Temperature	-46°C to 240°C	-46°C to 240°C	-46°C to 240°C	-46°C to 240°C
9. Material Class	Carbon Steel	Carbon Steel	Carbon Steel	Carbon Steel
10. Body and bonnet Material	ASTM A352 Gr LCB	ASTM A352 Gr LCB	ASTM A352 Gr LCB	ASTM A352 Gr LCB
11. Disc Material	AISI 316 + Stellite	AISI 316 + Stellite	AISI 316 + Stellite	AISI 316 + Stellite
12. Nozzle Material	AISI 316	AISI 316	AISI 316	AISI 316
13. Guide Material	AISI 316	AISI 316	AISI 316	AISI 316
14. Spindle Material	Martensitic SS 400 Series	Martensitic SS 400 Series	Martensitic SS 400 Series	Martensitic SS 400 Series
15. Spring Material	UNS N07750	UNS N07750	UNS N07750	UNS N07750
16. Bellow Material	Not applicable	Not applicable	Not applicable	UNS N06625
17. Valve Testing	API 527	API 527	API 527	API 527
18. Notes	Not Applicable	Not Applicable	Not Applicable	Not Applicable

Valve Code	PSV-HC-2-C21E	PSV-HC-2-C21F	PSV-HC-2-C21G	PSV-HC-2-D21D
Specs	H6 H10	H6 H10	H6 H10	H16
1. Valve Type	Balanced	Balanced	Balanced	Balanced
2. Orifice Size	Orifice E (0.196 in ²)	Orifice F (0.307 in ²)	Orifice G (0.503 in ²)	Orifice D (A=0.110 in ²)
3. Valve Specification Level (VSL)	VSL-2	VSL-2	VSL-2	VSL-2
4. Standard	API 520	API 520	API 520	API 520
5. Inlet/Outlet Size Range (NPS)	1 ½" x 3"	1 ½" x 3"	2" x 3"	1 ½" x 3"
6. Inlet/Outlet end connection	ASME B16.5, RTJ x ASME B16.5, RF	ASME B16.5, RTJ x ASME B16.5, RF	ASME B16.5, RTJ x ASME B16.5, RF	ASME B16.5, RTJ x ASME B16.5, RF
7. Inlet/Outlet pressure class	2500 x 300	2500 x 300	2500 x 300	2500 x 300
8. Temperature	-46°C to 240°C	-46°C to 240°C	-46°C to 240°C	-50°C to 100°C
9. Material Class	Carbon Steel	Carbon Steel	Carbon Steel	Duplex Steel
10. Body and bonnet Material	ASTM A352 Gr LCB	ASTM A352 Gr LCB	ASTM A352 Gr LCB	ASTM A995 Gr 4a
11. Disc Material	AISI 316 + Stellite	AISI 316 + Stellite	AISI 316 + Stellite	ASTM A479 (UNS S31803)
12. Nozzle Material	AISI 316	AISI 316	AISI 316	ASTM A479 (UNS S31803)
13. Guide Material	AISI 316	AISI 316	AISI 316	AISI 316
14. Spindle Material	Martensitic SS 400 Series	Martensitic SS 400 Series	Martensitic SS 400 Series	Martensitic SS 400 Series
15. Spring Material	UNS N07750	UNS N07750	UNS N07750	UNS N07750
16. Bellow Material	UNS N06625	UNS N06625	UNS N06625	UNS N06625
17. Valve Testing	API 527	API 527	API 527	API 527
18. Notes	Not Applicable	Not Applicable	Not Applicable	Not Applicable

Valve Code	PSV-HC-2-D21E	PSV-HC-2-D21F	PSV-HC-2-D21G	PSV-HC-2-D31D
Specs	H16	H16	H16	H12P H12
1. Valve Type	Balanced	Balanced	Balanced	Balanced
2. Orifice Size	Orifice E (0.196 in ²)	Orifice F (0.307 in ²)	Orifice G (0.503 in ²)	Orifice D (A=0.110 in ²)
3. Valve Specification Level (VSL)	VSL-2	VSL-2	VSL-2	VSL-2
4. Standard	API 520	API 520	API 520	API 520
5. Inlet/Outlet Size Range (NPS)	1 ½" x 3"	1 ½" x 3"	2" x 3"	1 ½" x 3"
6. Inlet/Outlet end connection	ASME B16.5, RTJ x ASME B16.5, RF	ASME B16.5, RTJ x ASME B16.5, RF	ASME B16.5, RTJ x ASME B16.5, RF	ASME B16.5, RTJ x ASME B16.5, RF
7. Inlet/Outlet pressure class	2500 x 300	2500 x 300	2500 x 300	2500 x 300
8. Temperature	-50°C to 100°C	-50°C to 100°C	-50°C to 100°C	-50°C to 110°C
9. Material Class	Duplex Steel	Duplex Steel	Duplex Steel	Duplex Steel
10. Body and bonnet Material	ASTM A995 Gr 4a	ASTM A995 Gr 4a	ASTM A995 Gr 4a	ASTM A995 Gr 6a
11. Disc Material	ASTM A479 (UNS S31803)	ASTM A479 (UNS S31803)	ASTM A479 (UNS S31803)	ASTM A479 (UNS S32760)
12. Nozzle Material	ASTM A479 (UNS S31803)	ASTM A479 (UNS S31803)	ASTM A479 (UNS S31803)	ASTM A479 (UNS S32760)
13. Guide Material	AISI 316	AISI 316	AISI 316	AISI 316
14. Spindle Material	Martensitic SS 400 Series	Martensitic SS 400 Series	Martensitic SS 400 Series	Martensitic SS 400 Series
15. Spring Material	UNS N07750	UNS N07750	UNS N07750	UNS N07750
16. Bellow Material	UNS N06625	UNS N06625	UNS N06625	UNS N06625
17. Valve Testing	API 527	API 527	API 527	API 527
18. Notes	Not Applicable	Not Applicable	Not Applicable	Not Applicable

Valve Code	PSV-HC-2-D31E	PSV-HC-2-D31F	PSV-HC-2-D31G	PSV-HC-2-N11D
Specs	H12P H12	H12P H12	H12P H12	H30
1. Valve Type	Balanced	Balanced	Balanced	Balanced
2. Orifice Size	Orifice E (0.196 in ²)	Orifice F (0.307 in ²)	Orifice G (0.503 in ²)	Orifice D (A=0.110 in ²)
3. Valve Specification Level (VSL)	VSL-2	VSL-2	VSL-2	VSL-2
4. Standard	API 520	API 520	API 520	API 520
5. Inlet/Outlet Size Range (NPS)	1 ½" x 3"	1 ½" x 3"	2" x 3"	1 ½" x 3"
6. Inlet/Outlet end connection	ASME B16.5, RTJ x ASME B16.5, RF	ASME B16.5, RTJ x ASME B16.5, RF	ASME B16.5, RTJ x ASME B16.5, RF	ASME B16.5, RTJ x ASME B16.5, RF
7. Inlet/Outlet pressure class	2500 x 300	2500 x 300	2500 x 300	2500 x 300
8. Temperature	-50°C to 110°C	-50°C to 110°C	-50°C to 110°C	-100°C to 155°C
9. Material Class	Duplex Steel	Duplex Steel	Duplex Steel	Nickel Alloys
10. Body and bonnet Material	ASTM A995 Gr 6a	ASTM A995 Gr 6a	ASTM A995 Gr 6a	UNS N06625
11. Disc Material	ASTM A479 (UNS S32760)	ASTM A479 (UNS S32760)	ASTM A479 (UNS S32760)	UNS N06625
12. Nozzle Material	ASTM A479 (UNS S32760)	ASTM A479 (UNS S32760)	ASTM A479 (UNS S32760)	ASTM B564 (UNS N06625)
13. Guide Material	AISI 316	AISI 316	AISI 316	AISI 316
14. Spindle Material	Martensitic SS 400 Series	Martensitic SS 400 Series	Martensitic SS 400 Series	Martensitic SS 400 Series
15. Spring Material	UNS N07750	UNS N07750	UNS N07750	UNS N07750
16. Bellow Material	UNS N06625	UNS N06625	UNS N06625	UNS N06625
17. Valve Testing	API 527	API 527	API 527	API 527
18. Notes	Not Applicable	Not Applicable	Not Applicable	Not Applicable

Valve Code	PSV-HC-2-N11E	PSV-HC-2-N11F	PSV-HC-2-N11G	PSV-HC-2-S21D
Specs	H30	H30	H30	H3 H6 H10
1. Valve Type	Balanced	Balanced	Balanced	Balanced
2. Orifice Size	Orifice E (0.196 in ²)	Orifice F (0.307 in ²)	Orifice G (0.503 in ²)	Orifice D (A=0.110 in ²)
3. Valve Specification Level (VSL)	VSL-2	VSL-2	VSL-2	VSL-2
4. Standard	API 520	API 520	API 520	API 520
5. Inlet/Outlet Size Range (NPS)	1 ½" x 3"	1 ½" x 3"	2" x 3"	1 ½" x 3"
6. Inlet/Outlet end connection	ASME B16.5, RTJ x ASME B16.5, RF	ASME B16.5, RTJ x ASME B16.5, RF	ASME B16.5, RTJ x ASME B16.5, RF	ASME B16.5, RTJ x ASME B16.5, RF
7. Inlet/Outlet pressure class	2500 x 300	2500 x 300	2500 x 300	2500 x 300
8. Temperature	-100°C to 155°C	-100°C to 155°C	-100°C to 155°C	-100°C to 260°C
9. Material Class	Nickel Alloys	Nickel Alloys	Nickel Alloys	Stainless Steel
10. Body and bonnet Material	UNS N06625	UNS N06625	UNS N06625	ASTM A182 Gr CF8M
11. Disc Material	UNS N06625	UNS N06625	UNS N06625	AISI 316 + Stellite
12. Nozzle Material	ASTM B564 (UNS N06625)	ASTM B564 (UNS N06625)	ASTM B564 (UNS N06625)	AISI 316
13. Guide Material	AISI 316	AISI 316	AISI 316	AISI 316
14. Spindle Material	Martensitic SS 400 Series	Martensitic SS 400 Series	Martensitic SS 400 Series	Martensitic SS 400 Series
15. Spring Material	UNS N07750	UNS N07750	UNS N07750	UNS N07750
16. Bellow Material	UNS N06625	UNS N06625	UNS N06625	UNS N06625
17. Valve Testing	API 527	API 527	API 527	API 527
18. Notes	Not Applicable	Not Applicable	Not Applicable	Not Applicable

Valve Code	PSV-HC-2-S21E	PSV-HC-2-S21F	PSV-HC-2-S21G
Specs	H3 H6 H10	H3 H6 H10	H3 H6 H10
1. Valve Type	Balanced	Balanced	Balanced
2. Orifice Size	Orifice E (0.196 in ²)	Orifice F (0.307 in ²)	Orifice G (0.503 in ²)
3. Valve Specification Level (VSL)	VSL-2	VSL-2	VSL-2
4. Standard	API 520	API 520	API 520
5. Inlet/Outlet Size Range (NPS)	1 ½" x 3"	1 ½" x 3"	2" x 3"
6. Inlet/Outlet end connection	ASME B16.5, RTJ x ASME B16.5, RF	ASME B16.5, RTJ x ASME B16.5, RF	ASME B16.5, RTJ x ASME B16.5, RF
7. Inlet/Outlet pressure class	2500 x 300	2500 x 300	2500 x 300
8. Temperature	-100°C to 260°C	-100°C to 260°C	-100°C to 260°C
9. Material Class	Stainless Steel	Stainless Steel	Stainless Steel
10. Body and bonnet Material	ASTM A182 Gr CF8M	ASTM A182 Gr CF8M	ASTM A182 Gr CF8M
11. Disc Material	AISI 316 + Stellite	AISI 316 + Stellite	AISI 316 + Stellite
12. Nozzle Material	AISI 316	AISI 316	AISI 316
13. Guide Material	AISI 316	AISI 316	AISI 316
14. Spindle Material	Martensitic SS 400 Series	Martensitic SS 400 Series	Martensitic SS 400 Series
15. Spring Material	UNS N07750	UNS N07750	UNS N07750
16. Bellow Material	UNS N06625	UNS N06625	UNS N06625
17. Valve Testing	API 527	API 527	API 527
18. Notes	Not Applicable	Not Applicable	Not Applicable