	TECHNICAL SPECIFICATION		Nº: I-ET-3010.2D-1200-800-P4X-005
	CLIENT: AGUP		SHEET: 1 of 48
	JOB: HIGH CAPACITY FPSO - GAS EXPORTATION ALL ELECTRIC		
	AREA: ATAPU 2 AND SÉPIA 2		
SRGE	TITLE: FIELD INSTRUMENTATION		INTERNAL
			ESUP

MICROSOFT WORD / V. 365 / I-ET-3010.2D-1200-800-P4X-005_C.DOC

INDEX OF REVISIONS

REV.	DESCRIPTION AND/OR REVISED SHEETS
0	ORIGINAL
A	REVISED WHERE INDICATED
B	REVISED WHERE INDICATED ACCORDING TO CONSISTENCY ANALYSIS
C	REVISED WHERE INDICATED

	REV. 0	REV. A	REV. B	REV. C	REV. D	REV. E	REV. F	REV. G	REV. H
DATE	JUL/27/22	OCT/21/22	DEC/02/22	DEC/16/22					
DESIGN	EEI	EEI	EEI	EEI					
EXECUTION	U361	C27N	U44D	U361					
CHECK	U44D	U361	U361	U44D					
APPROVAL	U5D6	U5D6	U5D6	U5D6					

INFORMATION IN THIS DOCUMENT IS PROPERTY OF PETROBRAS, BEING PROHIBITED OUTSIDE OF THEIR PURPOSE

FORM OWNED TO PETROBRAS N-0381 REV. L



TECHNICAL SPECIFICATION	Nº I-ET-3010.2D-1200-800-P4X-005	REV. C
AREA:	ATAPU 2 AND SÉPIA 2	SHEET 2 of 48
TITLE:	FIELD INSTRUMENTATION	INTERNAL
		ESUP

SUMMARY

1 INTRODUCTION.....	4
1.1 Object.....	4
1.2 Definitions	4
1.3 Abbreviations, Acronyms and Initialisms	4
2 REFERENCE DOCUMENTS, CODES AND STANDARDS	5
2.1 External References	5
2.2 Internal References	10
3 ENVIRONMENTAL AND OPERATION CONDITIONS.....	11
3.1 General	11
4 GENERAL REQUIREMENTS FOR THE INSTRUMENTATION SPECIFICATION.....	11
4.1 Requirements	11
4.2 Identification.....	12
5 REQUIREMENTS FOR SPECIFICATION OF PRESSURE INSTRUMENTS.....	13
5.1 General	13
5.2 Manometers (Pressure Gauges)	13
5.3 Pressure Transmitters	13
5.4 Differential Pressure Transmitters	13
5.5 Diaphragm Seals	13
6 REQUIREMENTS FOR SPECIFICATION OF TEMPERATURE INSTRUMENTS.....	14
6.1 General	14
7 REQUIREMENTS FOR SPECIFICATION OF LEVEL INSTRUMENTS.....	14
7.1 General	14
7.2 Energy Absorption Level Transmitter	15
7.3 Nucleonic Profiler Level Transmitter.....	16
7.4 Electrical Conductivity Profiler Level Transmitter	17
7.5 Level Gauge Indicators.....	17
7.6 Guided Wave Radar Level Transmitter	18
8 REQUIREMENTS FOR SPECIFICATION OF FLOW INSTRUMENTS.....	19
8.1 General	19
8.2 Orifice Plate Measurements	19
8.3 Positive Displacement Flow Meters.....	20
8.4 Mass (Coriolis) Flow Meters	20
8.5 Magnetic Flow Meters.....	21
8.6 Ultrasonic Meters.....	21
8.7 Cone Meters	21
9 CONTROL VALVES	21
9.1 General Requirements.....	21
9.2 Actuator.....	22
9.3 Positioners	23
9.4 Limit switches	23
9.5 Control Valves for Severe Service.....	23
10 CHOKE VALVES.....	23
10.1 General Requirements.....	23
11 ON-OFF VALVES	24

	TECHNICAL SPECIFICATION	Nº I-ET-3010.2D-1200-800-P4X-005	REV. C
	AREA:	ATAPU 2 AND SÉPIA 2	
	TITLE:	FIELD INSTRUMENTATION	SHEET 3 of 48
			INTERNAL
			ESUP

11.1 General Requirements.....	24
11.2 Shutdown Valves (SDV)	25
11.3 Blowdown Valves (BDV).....	25
11.4 Automatic Deluge Valves (ADV).....	26
12 SAFETY RELIEF VALVES (PSV)	27
12.1 General Requirements.....	27
13 ANALYZERS	28
13.1 General Requirements.....	28
13.2 Water in Oil Analyzers (BS&W)	29
13.3 Oil-in-Water Analyzers (TOG)	29
13.4 Oxygen Analyzer	31
13.5 Oxygen Analyzer for corrosion monitoring	32
13.6 Salinity Analyzer	32
13.7 Moisture Analyzer	32
13.8 Dew point Analyzer.....	33
13.9 CO ₂ Analyzer	34
13.10 H ₂ S Analyzer.....	34
13.11 Chlorine Analyzer	34
13.12 Gas Chromatograph	35
13.13 PH Analyzer.....	37
13.14 Density meters.....	37
14 REQUIREMENTS FOR SPECIFICATION OF SAFETY INSTRUMENTS	37
14.1 Gas Detectors.....	37
14.2 Flame Detectors	40
15 FLAME ARRESTERS.....	41
15.1 General Requirements.....	41
16 FUSIBLE PLUG	42
16.1 General Requirements.....	42
17 INSTALLATION MATERIALS.....	43
17.1 Junction Boxes (JB).....	43
17.2 Cable Glands	44
17.3 Cable Trays and Cables	45
17.4 Pushbuttons.....	45
17.5 Miscellaneous	46
18 INSTRUMENT ASSEMBLY MATERIAL.....	46
18.1 Material Selection Requirements.....	46
18.2 Electrical Hook-up.....	47
18.3 Heat Tracing	47

	TECHNICAL SPECIFICATION	Nº I-ET-3010.2D-1200-800-P4X-005	REV. C
	AREA:	ATAPU 2 AND SÉPIA 2	SHEET 4 of 48
	TITLE:	FIELD INSTRUMENTATION	INTERNAL
			ESUP

1 INTRODUCTION

1.1 Object

- 1.1.1 This technical specification, along with I-ET-3010.00-1200-800-P4X-013 – GENERAL CRITERIA FOR INSTRUMENTATION PROJECTS, defines the minimum requirements for the field instrumentation to be used in offshore units.
- 1.1.2 For equipment and instruments related to *flow metering system*, requirements of I-ET-3010.00-1200-813-P4X-001 - GENERAL CRITERIA FOR FLOW METERING SYSTEMS and I-ET-3010.2D-1200-800-P4X-003 - FLOW METERING SYSTEM (FMS) are also mandatory.
- 1.1.3 The use of instrument types not covered herein shall be submitted to Buyer for approval.

1.2 Definitions

- 1.2.1 Refer to I-ET-3010.00-1200-940-P4X-002 – GENERAL TECHNICAL TERMS.

1.3 Abbreviations, Acronyms and Initialisms

ADV	Automatic Deluge Valve
AEPR	Automation & Electrical Panels Room
AFDS	Addressable Fire Detection System
ALARM	Alarm Management System
BDV	Blowdown Valve
BS&W	Basic Sediments & Water
CCR	Central Control Room (located in the Hull Accommodation)
CSS	Control and Safety System
EMC	Electromagnetic Compatibility
FAT	Factory Acceptance Test
FGS	Fire and Gas System
FMS	Flow Metering System
FO	Restriction Orifice
HART	Highway Addressable Remote Transducer
HMI	Human-Machine Interface
IP	Ingress Protection Ratings
IR	Infrared
LEL	Lower Explosive Limit
OD	Outside Diameter
PCS	Process Control System
P&ID	Piping and Instrument Diagram
PSD	Process Shutdown System
PSV	Safety Relief Valve
SDV	Shutdown Valve
SOS	Supervision and Operation System
TOG	Total Oil and Grease
UV	Ultraviolet
UV-Vis	Ultraviolet-Visible

	TECHNICAL SPECIFICATION	Nº I-ET-3010.2D-1200-800-P4X-005	REV. C
	AREA:	ATAPU 2 AND SÉPIA 2	
	TITLE:	FIELD INSTRUMENTATION	SHEET 5 of 48 INTERNAL ESUP

XV ON-OFF Valve

2 REFERENCE DOCUMENTS, CODES AND STANDARDS

2.1 External References

2.1.1 International Codes, Recommended Practices and Standards.

API - AMERICAN PETROLEUM INSTITUTE

API	MPMS	MANUAL OF PETROLEUM MEASUREMENT STANDARDS - ALL PARTS
API	STD 6FA	STANDARD FIRE TEST FOR VALVES
API	RP 14C	ANALYSIS, DESIGN, INSTALLATION AND TESTING OF SAFETY SYSTEMS FOR OFFSHORE PRODUCTION FACILITIES
API	STD 520-PT I	SIZING, SELECTION AND INSTALLATION OF PRESSURE-RELIEVING DEVICES - PART I - SIZING AND SELECTION
API	STD 520- PT II	SIZING, SELECTION, AND INSTALLATION OF PRESSURE - RELIEVING DEVICES - PART II - INSTALLATION
API	RP 551	PROCESS MEASUREMENT
API	RP 552	TRANSMISSION SYSTEMS
API	RP 554	PROCESS CONTROL SYSTEMS - ALL PARTS
API	RP 555	PROCESS ANALYZERS
API	STD 526	FLANGED STEEL PRESSURE RELIEF VALVES
API	STD 527	SEAT TIGHTNESS OF PRESSURE RELIEF VALVES
API	STD 598	VALVE INSPECTION AND TESTING

ASME - AMERICAN SOCIETY OF MECHANICAL ENGINEERS

ASME PTC 19.3 TW THERMOWELLS PERFORMANCE TEST CODES

ASTM – AMERICAN SOCIETY FOR TESTING AND MATERIALS

ASTM F1273 STANDARD SPECIFICATION FOR TANK VENT FLAME ARRESTERS

	TECHNICAL SPECIFICATION	Nº I-ET-3010.2D-1200-800-P4X-005	REV. C
	AREA:	ATAPU 2 AND SÉPIA 2	SHEET 6 of 48
	TITLE:	FIELD INSTRUMENTATION	INTERNAL ESUP

ANSI – American National Standards Institute

ANSI FCI 70-2 CONTROL VALVE SEAT LEAKAGE

IEC - INTERNATIONAL ELECTROTECHNICAL COMMISSION

IEC 60068 ENVIRONMENTAL TESTING

IEC 60079 EXPLOSIVE ATMOSPHERES

IEC 60092-350 ELECTRICAL INSTALLATIONS IN SHIPS – PART 350 - GENERAL CONSTRUCTION AND TEST METHODS OF POWER, CONTROL AND INSTRUMENTATION CABLES FOR SHIPBOARD AND OFFSHORE APPLICATIONS

IEC 60092-376 ELECTRICAL INSTALLATIONS IN SHIPS – PART 376 - CABLES FOR CONTROL AND INSTRUMENTATION CIRCUITS 150/250 V (300 V)

IEC 60092-504 ELECTRICAL INSTALLATIONS IN SHIPS - PART 504: AUTOMATION, CONTROL AND INSTRUMENTATION

IEC 60331 TESTS FOR ELECTRIC CABLES UNDER FIRE CONDITIONS - CIRCUIT INTEGRITY

IEC 60529 DEGREES OF PROTECTION PROVIDED BY ENCLOSURES (IP CODE)

IEC 60533 ELECTRICAL AND ELECTRONIC INSTALLATIONS IN SHIPS - ELECTROMAGNETIC COMPATIBILITY (EMC) – SHIPS WITH METALLIC HULL

IEC 60534-8-3 INDUSTRIAL PROCESS CONTROL VALVES – PART 8-3: NOISE CONSIDERATIONS – CONTROL VALVE AERODYNAMIC NOISE PREDICTION METHOD

IEC 60534-8-4 INDUSTRIAL PROCESS CONTROL VALVES – PART 8-4: NOISE CONSIDERATIONS – PREDICTION OF NOISE GENERATED BY HYDRODYNAMIC FLOW

IEC 60945 MARITIME NAVIGATION AND RADIOCOMMUNICATION EQUIPMENT AND SYSTEMS – GENERAL REQUIREMENTS – METHODS OF TESTING AND REQUIRED TEST RESULTS

IEC 61000 ELECTROMAGNETIC COMPATIBILITY (EMC)

IEC 61892-6 MOBILE AND FIXED OFFSHORE UNITS - ELECTRICAL INSTALLATIONS - PART 6: INSTALLATION

IEC 61892-7 MOBILE AND FIXED OFFSHORE UNITS - ELECTRICAL INSTALLATIONS - PART 7: HAZARDOUS AREAS

IEC 62337 COMMISSIONING OF ELECTRICAL, INSTRUMENTATION AND CONTROL SYSTEMS IN THE PROCESS INDUSTRY – SPECIFIC PHASES AND MILESTONES

IEC 62381 AUTOMATION SYSTEMS IN THE PROCESS INDUSTRY- FACTORY ACCEPTANCE TEST (FAT), SITE ACCEPTANCE TEST (SAT) AND SITE INTEGRATION TEST (SIT)

	TECHNICAL SPECIFICATION	Nº I-ET-3010.2D-1200-800-P4X-005	REV. C
	AREA:	ATAPU 2 AND SÉPIA 2	SHEET 7 of 48
	TITLE:	FIELD INSTRUMENTATION	INTERNAL
			ESUP
IEC	62382	CONTROL SYSTEMS IN THE PROCESS INDUSTRY – ELECTRICAL AND INSTRUMENTATION LOOP CHECK	
ISA - INTERNATIONAL SOCIETY OF AUTOMATION			
ISA	RP 42.00.01	NOMENCLATURE FOR INSTRUMENT TUBE FITTINGS	
ISA	TR 20.00.01	SPECIFICATION FORMS FOR PROCESS MEASUREMENT AND CONTROL INSTRUMENTS - PART 1: GENERAL CONSIDERATIONS	
ISA	18.1	ANNUNCIATOR SEQUENCES AND SPECIFICATIONS	
ISA	20	SPECIFICATION FORMS FOR PROCESS MEASUREMENT AND CONTROL INSTRUMENTS, PRIMARY ELEMENTS, AND CONTROL VALVES	
ISA	51.1	PROCESS INSTRUMENTATION TERMINOLOGY	
ISA	75.01.01	INDUSTRIAL PROCESS CONTROL VALVES – PART 2-1: FLOW CAPACITY – SIZING EQUATIONS FOR FLUID FLOW UNDER INSTALLED CONDITIONS	
ISA	75.05.01	CONTROL VALVE TERMINOLOGY	
ISA	92.00.01	PERFORMANCE REQUIREMENTS FOR TOXIC GAS DETECTORS	
ISA	92.00.02	INSTALLATION, OPERATION, AND MAINTENANCE OF TOXIC GAS-DETECTION INSTRUMENTS	

	TECHNICAL SPECIFICATION	Nº I-ET-3010.2D-1200-800-P4X-005	REV. C
	AREA:	ATAPU 2 AND SÉPIA 2	SHEET 8 of 48
	TITLE:	FIELD INSTRUMENTATION	INTERNAL ESUP

ISO - INTERNATIONAL ORGANIZATION FOR STANDARDIZATION

- ISO 5167-1 MEASUREMENT OF FLUID FLOW BY MEANS OF PRESSURE DIFFERENTIAL DEVICES INSERTED IN CIRCULAR CROSS-SECTION CONDUITS RUNNING FULL - PART 1: GENERAL PRINCIPLES AND REQUIREMENTS
- ISO 5167-2 MEASUREMENT OF FLUID FLOW BY MEANS OF PRESSURE DIFFERENTIAL DEVICES INSERTED IN CIRCULAR CROSS-SECTION CONDUITS RUNNING FULL - PART 2: ORIFICE PLATES
- ISO 5167-5 MEASUREMENT OF FLUID FLOW BY MEANS OF PRESSURE DIFFERENTIAL DEVICES INSERTED IN CIRCULAR CROSS-SECTION CONDUITS RUNNING FULL - PART 5: CONE METERS
- ISO 10497 TESTING OF VALVES - FIRE TYPE-TESTING REQUIREMENTS
- ISO 12490 PETROLEUM AND NATURAL GAS INDUSTRIES — MECHANICAL INTEGRITY AND SIZING OF ACTUATORS AND MOUNTING KITS FOR PIPELINE VALVES
- ISO 13702 PETROLEUM AND NATURAL GAS INDUSTRIES – CONTROL AND MITIGATION OF FIRES AND EXPLOSIONS ON OFFSHORE PRODUCTION INSTALLATIONS - REQUIREMENTS AND GUIDELINES
- ISO 15848 INDUSTRIAL VALVES – MEASUREMENT TEST AND QUALIFICATION PROCEDURES FOR FUGITIVE EMISSIONS – ALL PARTS
- ISO 16852 FLAME ARRESTERS – PERFORMANCE REQUIREMENTS, TEST METHODS AND LIMITS FOR USE.
- ISO 18453 NATURAL GAS CORRELATION BETWEEN WATER CONTENT AND WATER DEW POINT
- ISO 23251 PETROLEUM, PETROCHEMICAL AND NATURAL GAS INDUSTRIES - PRESSURE-RELIEVING AND DEPRESSURING SYSTEMS
- ISO 20456 MEASUREMENT OF FLUID FLOW IN CLOSED CONDUITS - GUIDANCE FOR THE USE OF ELECTROMAGNETIC FLOWMETERS FOR CONDUCTIVE LIQUIDS.

	TECHNICAL SPECIFICATION	Nº I-ET-3010.2D-1200-800-P4X-005	REV. C
	AREA:	ATAPU 2 AND SÉPIA 2	SHEET 9 of 48
	TITLE:	FIELD INSTRUMENTATION	INTERNAL ESUP

NACE - THE NATIONAL ASSOCIATION OF CORROSION ENGINEERS

NACE MR0175 / ISO PETROLEUM AND NATURAL GAS INDUSTRIES –
15156 CIR 1 MATERIALS FOR USE IN H₂S – CONTAINING
TO PT 3 ENVIRONMENTS IN OIL AND GAS PRODUCTION –
PART 3: CRACKING-RESISTANT CRAS (CORROSION-
RESISTANT ALLOYS) AND OTHER ALLOYS
TECHNICAL CIRCULAR 1 TO PART 3

NFPA - NATIONAL FIRE PROTECTION ASSOCIATION

NFPA 15 STANDARD FOR WATER SPRAY FIXED SYSTEMS FOR
FIRE PROTECTION
NFPA 72 NATIONAL FIRE ALARM AND SIGNALLING CODE
NFPA 496 STANDARD FOR PURGED AND PRESSURIZED
ENCLOSURES FOR ELECTRICAL EQUIPMENT

OIML – ORGANISATION INTERNATIONALE DE MÉTROLOGIE LÉGALE

OIML R117 DYNAMIC MEASURING SYSTEMS FOR LIQUIDS
OTHER THAN WATER

**ANP - AGÊNCIA NACIONAL DO PETRÓLEO, GÁS NATURAL E
BIOCOMBUSTÍVEIS**

RESOLUÇÃO CONJUNTA ANP-INMETRO Nº 1”,
ISSUED ON JUNE, 10th, 2013.
ANP/INMETRO NOTE: INCLUDES THE API, ISO, AGA, OIML ETC.
Nº1 STANDARDS MENTIONED IN THAT DOCUMENT.
(10/JUNHO/2013)

**INMETRO - INSTITUTO NACIONAL DE METROLOGIA, NORMALIZAÇÃO E
QUALIDADE INDUSTRIAL**

PORTARIA Nº 115 REQUISITOS DE AVALIAÇÃO DA CONFORMIDADE
(21/MARÇO/2022) PARA EQUIPAMENTOS ELÉTRICOS PARA
ATMOSFERAS EXPLOSIVAS - CONSOLIDADO.

2.1.2 All SIT – Secretaria de Inspeção do Trabalho Regulatory Standards (NRs) shall be followed.

2.1.3 Classification Society

2.1.3.1 The detailed design shall be submitted to approval by Classification Society. The design and installation shall take into account their requirements and comments.

	TECHNICAL SPECIFICATION	Nº I-ET-3010.2D-1200-800-P4X-005	REV. C
	AREA:	ATAPU 2 AND SÉPIA 2	
	TITLE:	FIELD INSTRUMENTATION	SHEET 10 of 48
			INTERNAL
			ESUP

2.2 Internal References

2.2.1 PETROBRAS General Specifications

DR-ENGP-M-I-1.3	SAFETY ENGINEERING
DR-ENGP-I-1.15	COLOR CODING
I-ET-3000.00-1200-940-P4X-001	TAGGING PROCEDURE FOR PRODUCTION UNITS DESIGN
I-ET-3010.00-1200-940-P4X-002	GENERAL TECHNICAL TERMS
I-ET-3010.00-1200-800-P4X-013	GENERAL CRITERIA FOR INSTRUMENTATION PROJECTS
I-ET-3010.00-1200-813-P4X-001	GENERAL CRITERIA FOR FLOW METERING SYSTEMS
I-ET-3010.00-5520-888-P4X-001	AUTOMATION PANELS
I-ET-3010.00-5520-800-P4X-001	SUPERVISION AND OPERATION SYSTEM (SOS) SCREENS
I-ET-3010.00-5140-700-P4X-002	SPECIFICATION FOR ELECTRICAL MATERIAL FOR OFFSHORE UNITS
I-ET-3010.00-5140-700-P4X-001	SPECIFICATION FOR ELECTRICAL DESIGN FOR OFFSHORE UNITS
I-ET-3010.00-5140-700-P4X-003	ELECTRICAL REQUIREMENTS FOR PACKAGES FOR OFFSHORE UNITS
I-ET-3010.00-1200-956-P4X-002	GENERAL PAINTING
I-DE-3010.2D-1200-944-P4X-001	GENERAL NOTES
I-ET-3010.2D-1200-200-P4X-001	PIPING SPECIFICATION FOR TOPSIDES
I-ET-3010.2E-1200-200-P4X-001	PIPING SPECIFICATION FOR HULL
I-ET-3010.2D-1200-800-P4X-001	INSTRUMENTATION ADDITIONAL TECHNICAL REQUIREMENTS
I-ET-3010.2D-1200-800-P4X-003	FLOW METERING SYSTEM (FMS)
I-FD-3010.2D-5400-947-P4X-001	SAFETY DATA SHEET - TOPSIDE
I-FD-3010.2E-5400-947-P4X-001	SAFETY DATA SHEET - HULL
I-MD-3010.2D-1200-940-P4X-011	DESCRIPTIVE MEMORANDUM - AUTOMATION & CONTROL.

NOTE: All P&IDs listed in I-LD-3010.2D-1200-940-P4X-002 – DOCUMENT LIST and in I-LD-3010.2E-1200-940-P4X-002 - DOCUMENT LIST HULL shall be considered as reference.

	TECHNICAL SPECIFICATION	Nº I-ET-3010.2D-1200-800-P4X-005	REV. C
	AREA:	ATAPU 2 AND SÉPIA 2	
	TITLE:	FIELD INSTRUMENTATION	SHEET 11 of 48 INTERNAL ESUP

3 ENVIRONMENTAL AND OPERATION CONDITIONS

3.1 General

- 3.1.1 For operating and environmental conditions refer to I-ET-3010.2D-1200-800-P4X-001 – INSTRUMENTATION ADDITIONAL TECHNICAL REQUIREMENTS.
- 3.1.2 All material used shall be non-hygroscopic, flame retardant and resistant to corrosion caused by marine environmental and hydrocarbon continuous contact.

4 GENERAL REQUIREMENTS FOR THE INSTRUMENTATION SPECIFICATION

4.1 Requirements

- 4.1.1 All instruments shall fully comply with I-ET-3010.00-1200-800-P4X-013 - GENERAL CRITERIA FOR INSTRUMENTATION PROJECTS requirements, as well as with the requirements listed in this specification.
- 4.1.2 Instruments of the same type and function shall be of the same manufacturer.
- 4.1.3 Instrument air-supply regulator filters shall be of coalescent type.
- 4.1.4 Solenoid valves shall not be used for diameter greater than 1”.
- 4.1.5 For air consumption calculation, in addition to requirements of I-ET-3010.00-1200-800-P4X-013 – GENERAL CRITERIA FOR INSTRUMENTATION PROJECTS, gastight dampers can be considered as intermittent consumers and, thus, do not need to be taken into account for air consumption calculation.
- 4.1.6 The instruments, valves, devices accessories shall be specified with suitable materials for services with H₂S content as indicated by process data to prevent sulfide stress cracking and corrosion. The following standards, in the latest revisions, shall be reference for material specification in such cases:
- NACE STANDARD MR0175/ISO 15156 CIR 1 TO PT 3 – PETROLEUM AND NATURAL GAS INDUSTRIES – MATERIALS FOR USE IN H₂S – CONTAINING ENVIRONMENTS IN OIL AND GAS PRODUCTION - PART 3:CRACKING-RESISTANT CRAS(CORROSION-RESISTANT ALLOYS) AND OTHER ALLOYS TECHNICAL CIRCULAR 1 TO PART 3;
 - API RP 551 – PROCESS MEASUREMENT INSTRUMENTATION.
- 4.1.7 Process connection shall not be used for supporting heavier instruments, including manifolds, diaphragm seals etc. In these cases, other means for supporting shall be in accordance with API RP 551.
- 4.1.8 All Ex-p equipment shall send to CSS a “ready to start” signal conditioned to the occurrence of purge after a shutdown. This absence of the confirmation from this signal shall prevent the respective equipment from starting.

	TECHNICAL SPECIFICATION	Nº I-ET-3010.2D-1200-800-P4X-005	REV. C
	AREA:	ATAPU 2 AND SÉPIA 2	SHEET 12 of 48
	TITLE:	FIELD INSTRUMENTATION	INTERNAL
			ESUP

4.1.9 All instruments that need a power supply higher than 24VDC shall be fed according to I-ET-3010.00-5140-700-P4X-003 – ELECTRICAL REQUIREMENTS FOR PACKAGES FOR OFFSHORE UNITS. Remote I/O panels are only able to supply 24VDC. For further details, refer to I-ET-3010.00-5520-888-P4X-001 - AUTOMATION PANELS.

4.1.10 All instruments shall be stored in a room with controlled temperature and humidity while not hooked up to their final position. Some instruments, such as analyzers, shall be stored powered on; others may have a preservation heater that shall remain powered on for as long as the equipment is not operational. Preservation shall be according to manufacturer requirements.

4.1.11 Instruments installed in high elevation that need support shall be provided with extra safeguarding to prevent them from falling down. It shall not be used glue in supports.

4.1.12 Temperature, pressure and level gauges shall be positioned so that scale visibility in ergonomic fashion is guaranteed. If proper positioning is not feasible, fixed platforms for Operator's access shall be foreseen. For further details, refer to I-ET-3010.00-1200-800-P4X-013 – GENERAL CRITERIA FOR INSTRUMENTATION PROJECTS.

4.1.13 It shall be foreseen facilities / available space for removal and maintenance of all instruments installed in tanks/vessels during operation phase.

4.1.14 Differential pressure transmitters shall have both high and low pressure taps ("H" and "L" respectively) clearly and visibly indicated on their bodies despite of being used as level, flow or differential pressure sensors.

4.2 Identification

4.2.1 Identification of instruments shall follow I-ET-3010.00-1200-800-P4X-013 – GENERAL CRITERIA FOR INSTRUMENTATION PROJECTS.

	TECHNICAL SPECIFICATION	Nº I-ET-3010.2D-1200-800-P4X-005	REV. C
	AREA: ATAPU 2 AND SÉPIA 2	SHEET 13 of 48	
	TITLE: FIELD INSTRUMENTATION	INTERNAL	
		ESUP	

5 REQUIREMENTS FOR SPECIFICATION OF PRESSURE INSTRUMENTS

5.1 General

5.1.1 For connection of pressure instruments, see I-ET-3010.00-1200-800-P4X-013 – GENERAL CRITERIA FOR INSTRUMENTATION PROJECTS.

5.2 Manometers (Pressure Gauges)

5.2.1 Pressure gauges on steam service shall be provided with a siphon coil (pig tail type) connection. Pressure gauges on pulsating service measurements (such as discharge of reciprocating compressors, pumps etc.) shall be provided with a pulsation damper.

5.2.2 2-way manifold (1 blocking and 1 drain) shall be provided for impulse line installation or alternately, close-coupled AISI 316 stainless steel 2-valve manifold according to API 551.

5.3 Pressure Transmitters

5.3.1 Pressure instruments in hot condensable gas, vapors and steam service shall be protected from process media by siphons coils or condensate seals.

5.3.2 2-way manifold (1 blocking and 1 drain) shall be provided for impulse line installation or alternately, close-coupled AISI 316 stainless steel 2-valve manifold according to API 551.

5.4 Differential Pressure Transmitters

5.4.1 Differential pressure transmitters shall be provided with close-coupled AISI 316 stainless steel 5-valve manifold.

5.5 Diaphragm Seals

5.5.1 The filling liquid chosen shall be compatible with the maximum process temperature.

5.5.2 Diaphragm seals shall be provided with a flushing ring between the process and the instrument connection to facilitate flushing with liquid from an external source, as per I-ET-3010.00-1200-800-P4X-013 – GENERAL CRITERIA FOR INSTRUMENTATION PROJECTS. There shall have 2 (two) flushing connections ½" NPT(F) located on opposite sides of the ring and provided with vent and drain valves.

5.5.3 The type of capillary extension or sealing system legs (filling fluid, diameter etc.) shall minimize the influence of process and ambient temperature changes on the measurement. Response time of sealing systems shall be 5 s maximum.

	TECHNICAL SPECIFICATION	Nº I-ET-3010.2D-1200-800-P4X-005	REV. C
	AREA: ATAPU 2 AND SÉPIA 2	SHEET 14 of 48	
	TITLE: FIELD INSTRUMENTATION	INTERNAL ESUP	

5.5.4 Diaphragm seals shall be of integral design. Where capillary extensions shall be used, the extension shall be AISI 316 stainless steel with AISI 316 stainless steel armoring and PVC covering. Capillary extensions shall be welded on both diaphragm seal and instrument sides. If required, provision shall be made to heat tracing the capillary extensions.

5.5.5 Care shall be taken in routing the capillary or sealing system legs to avoid effects of ambient temperature on the thermal expansion of the filling liquid. The capillary extension, if required, shall be provided with thermal insulation. Capillary system shall be accommodated and firmly attached in covered trays, capillary free running shall not exceed 2.5 meter. Capillary shall be fixed by metallic tape with polymeric material. Minimum curve radii shall be informed and used as base for routing.

5.5.6 Diaphragm seals shall not be used on vacuum services.

5.5.7 Diaphragm seals shall be installed in a position avoiding deposit of dirt or debris on the seal surface.

6 REQUIREMENTS FOR SPECIFICATION OF TEMPERATURE INSTRUMENTS

6.1 General

6.1.1 For Temperature elements', gauges' and transmitters', as well as thermowells' requirements refer to I-ET-3010.00-1200-800-P4X-013 – GENERAL CRITERIA FOR INSTRUMENTATION PROJECTS.

6.1.2 Accuracy of temperature transmitters shall be ± 0.5 °C.

6.1.3 Where high vibration is expected, such as in dynamic equipment discharge line, temperature sensor shall be specified as vibration resistant type.

7 REQUIREMENTS FOR SPECIFICATION OF LEVEL INSTRUMENTS

7.1 General

7.1.1 For level gauges and level transmitters requirements, as well as level measurement technologies selection and installation guidelines, refer to I-ET-3010.00-1200-800-P4X-013 – GENERAL CRITERIA FOR INSTRUMENTATION PROJECTS. In addition, the following general and specific requirements are mandatory.

7.1.2 The installation of level instruments shall not be susceptible to the accumulation of dirt on the surroundings of the meter/sensor.

7.1.3 The use of perforated stilling well is mandatory for top mounted internal level measurement. Design, fabrication and installation of stilling wells shall be so as to avoid dirt built-up on its inside and surroundings.

	TECHNICAL SPECIFICATION	Nº I-ET-3010.2D-1200-800-P4X-005	REV. C
	AREA:	ATAPU 2 AND SÉPIA 2	
	TITLE:	FIELD INSTRUMENTATION	
		SHEET 15 of 48 INTERNAL ESUP	

- 7.1.4 Level instruments' process connections shall be hooked up to taps on the sides of the monitored vessels, never to taps on their bottom.
- 7.1.5 The use of monoflange wafer valves is not allowed.
- 7.1.6 For services in the presence of gas and applications with potential loss of production, all level instruments shall have double block and bleed valves (DBB) for process connections.
- 7.1.7 Should electric heat tracing be necessary, see item 18.3 for details.
- 7.1.8 Whenever the level transmitter uses a capillary with a remote seal and the response time is critical or the installation requires a complex routing of the capillary, it shall be considered, as an alternative, the use of a level measurement technology consisting of two absolute pressure sensors, both with diaphragm seal in integral mount, wired to each other, calculating the differential pressure and one of them performing the function of level transmitter, instead of only one D/P cell. For this type of instrument shall be presented, for buyer approval, the maximum level measurement error due to static pressure.
- 7.1.9 A document describing a Vessel/Tank sketch of all level instruments connections shall be issued, during Detailed Engineering Design. The Level Sketch document shall be issued according to the following template:



I-DE-3010.XX-XXXXX
_LEVEL_SKETCH.xlsx

- 7.1.10 For Radar Level Transmitter, 3D modeling shall consider a cylinder between the bottom of the instrument to the bottom of the tank/vessel in order to avoid any interference of piping or structures in the level measurement.

7.2 Energy Absorption Level Transmitter

- 7.2.1 Energy absorption transmitter shall be used for oil-water interface level measurement in:
- Oil Dehydrators (TO-1223001 A/B and TO-1223002 A/B): interlocking purposes
 - Water Separators (SG-1223001A/B and SG-1223002): interlocking purposes;
 - Water tanks (TQ-5331501P and TQ-5331501S): interlocking purposes.
- 7.2.2 There shall be 3 (three) transmitters to be wired to PSD in each of the 9 (nine) aforementioned vessels (TO-1223001A/B, TO-1223002A/B, SG-1223001A/B, SG-1223002, TQ-5331501P and TQ-5331501S): one dedicated to generate a high-high level interlock (LSHH), one dedicated to generate a low-low level interlock (LSLL) and one dedicated to a level indication (LI).
- 7.2.3 These transmitters shall be installed by the side of the vessel. Their communication protocol shall be 4-20 mA + HART.

	TECHNICAL SPECIFICATION	Nº I-ET-3010.2D-1200-800-P4X-005	REV. C
	AREA:	ATAPU 2 AND SÉPIA 2	SHEET 16 of 48
	TITLE:	FIELD INSTRUMENTATION	INTERNAL
			ESUP

7.2.4 Seal housing devices shall be available for maintenance and range adjustment of the transmitters without need to stop the process. Design and sizing shall be according to manufacturer. Special tools for removal and maintenance shall also be supplied.

7.2.5 For energy absorption level transmitters, the probes process hook up shall be approved by Buyer before installation.

7.3 Nucleonic Profiler Level Transmitter

7.3.1 This type of level transmitter shall be used for interface measurement in Water Separators (SG-1223001A/B and SG-1223002) for control only.

7.3.2 There shall be one transmitter for each of the 3 (three) aforementioned vessels (SG-1223001A/B and SG-1223002), mounted at their top.

7.3.3 Each one of these transmitters shall have 2 (two) probes for reception.

7.3.4 Each transmitter is connected to a panel; being those panels located at AEPR. Each panel houses a PLC dedicated to performing software actions in the level measurement, such as filter oscillations in the readings. These panels shall communicate through 4-20 mA signal with CSS.

7.3.5 Each one of these panels shall send 5 (five) 4-20 mA signals to CSS, each one dedicated to:

- Sand-water interface
- Water-emulsion interface (NOTE)
- Emulsion-oil Interface
- Oil-foam interface
- Foam-gas interface

NOTE: This signal shall be used to control the Water Level Control Valve.

7.3.6 Each one of these transmitters shall communicate with CSS through Modbus link to provide information related to signal strength and diagnostics to each detector of the 2 (two) probes.

7.3.7 Each one of these transmitters shall have a dedicated screen configured in SOS according to manufacturer standards. For further details, refer to I-ET-3010.00-5520-800-P4X-001 – SUPERVISION AND OPERATION SYSTEM (SOS) SCREENS.

7.3.8 Nucleonic profiler level transmitters that need isolated area surrounding the vessel are not accepted.

	TECHNICAL SPECIFICATION	Nº I-ET-3010.2D-1200-800-P4X-005	REV. C
	AREA:	ATAPU 2 AND SÉPIA 2	
	TITLE:	FIELD INSTRUMENTATION	SHEET 17 of 48
			INTERNAL
			ESUP

7.3.9 For all radioactive materials and equipment supplied with the UNIT, SELLER shall comply with applicable CNEN (Comissão Nacional de Energia Nuclear, part of Ministry of Science, Technology and Innovation) requirements and is responsible for the collection, management, handling, temporary storage and final disposal of any contaminated waste, including radioactive sources until UNIT handover.

7.4 Electrical Conductivity Profiler Level Transmitter

7.4.1 This type of level transmitter shall be used for interface measurement control in Oil Dehydrators (TO-1223001A/B and TO-1223002A/B).

7.4.2 Those transmitters shall be mounted at the top of the aforementioned vessels, in a 6" flange. It is recommended to install this instrument so that the flow passes through the rings (rings orthogonal to the flow).

7.4.3 Maintenance space for removal of this instrument during operation phase shall be foreseen. All other provisions necessary for the operation of this transmitter (such as nitrogen supply for pressurization), shall also be foreseen.

7.5 Level Gauge Indicators

7.5.1 Level gauges shall have drain and vent connections with valves and caps included in the instrument.

7.5.2 Level gauges shall have adequate heating when operating with viscous product subject to solidification at environment temperature. See section 18.3 for other requirements.

7.5.3 Each level gauge shall have its visible range greater than the range of the correspondent level transmitter. Along with the level gauge, a graduated scale shall be supplied, both in percentage and mm, indicating:

- Tag of the correspondent LIT;
- Control set-points (LSL and LSH);
- Interlocking set points (LSLL and LSHH);
- Expected maximum level discrepancy to LIT reading, due to density variations.

7.5.4 Whenever more than one level gauge is installed in the same vessel, there shall be an overlap between two adjacent gauges (i.e., the top process connection of the lower level gauge shall be above the bottom process connection of the upper level gauge) of at least 50 mm of visible range.

7.5.5 For condensates and applications with viscous and dirty fluids with the possibility of fouling, magnetic type level gauge with sealed buoy shall be used. Means shall be provided to prevent the collapse of the buoy.

	TECHNICAL SPECIFICATION	Nº I-ET-3010.2D-1200-800-P4X-005	REV. C
	AREA: ATAPU 2 AND SÉPIA 2	SHEET 18 of 48	
	TITLE:	FIELD INSTRUMENTATION	
		INTERNAL	
		ESUP	

- 7.5.5.1 For oil and gas applications, Slop Vessel – V-5336501, Safety Gas K.O Drum - V-1231001, Main Gas Compressor Suction Scrubber - V-UC-1231001A/C-01, High/Low Pressure Flare KO. Drums - V-5412001 and V-5412002, Deaerators (for example UT-1251003 and D-UT-1251003) and Sodium Hydroxide Tank – TQ-UQ-1261001-05 magnetic level gauges shall be of eccentric type, in order to avoid buoy jamming. Buoy coating for slip assistance shall be considered. The buoy shall be sealed. The body of the level gauge shall be 3 inches.
- 7.5.6 Reflex type level gauges process connections shall be TOP-BOTTOM; Magnetic type level gauges process connections shall be SIDE-SIDE. Level gauges shall allow adjustment of the visual field by turning the display.
- 7.5.7 Gauges shall be positioned so that scale visibility in ergonomic fashion is guaranteed. If proper positioning is not feasible, fixed platforms for Operator’s access shall be foreseen.
- 7.5.8 Measuring range of magnetic type level gauges shall be aligned with the flanges according to following drawing:

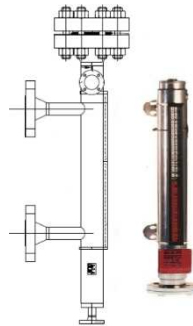



Figure 1 - Magnetic type gauge alignment

7.6 Guided Wave Radar Level Transmitter

- 7.6.1 The probes of guided wave radar level transmitters shall be rigid type.
- 7.6.2 The probes of guided wave radar level transmitters shall not touch any metallic surfaces.
- 7.6.3 The Waveguide fixing method shall be evaluated during the detailing phase to avoid pendulum movement caused by process flow or hull sway.

	TECHNICAL SPECIFICATION	Nº I-ET-3010.2D-1200-800-P4X-005	REV. C
	AREA:	ATAPU 2 AND SÉPIA 2	SHEET 19 of 48
	TITLE:	FIELD INSTRUMENTATION	INTERNAL
			ESUP

8 REQUIREMENTS FOR SPECIFICATION OF FLOW INSTRUMENTS

8.1 General

8.1.1 Refer to I-ET-3010.00-1200-800-P4X-013 – GENERAL CRITERIA FOR INSTRUMENTATION PROJECTS and I-ET-3010.00-1200-813-P4X-001 - GENERAL CRITERIA FOR FLOW METERING SYSTEMS for mandatory technical requirements on flow meters. Elements, transmitters and accessories shall also comply with all requirements under the following items.

8.1.2 Minimum straight upstream/downstream pipe runs length shall comply with, whichever is larger among: manufacturer's recommendation, or:

- ISO 5167-1 and ISO 5167-2 – for metering by orifice plate;
- ISO 5167-5 – for metering by V-cone meter;
- AGA-9 – for gas metering by ultrasonic flow meter;
- API MPMS 5.6 – for oil metering by Coriolis flow meter;
- API MPMS 5.8 – for oil metering by ultrasonic flow meter;
- ISO 20456 – for magnetic flow meter.

8.2 Orifice Plate Measurements

8.2.1 Smart transmitters with 4 – 20 mA + HART output shall be used.

8.2.2 Multivariable sensors transmitters may be used as an alternative to 3 (three) smart transmitters.

8.2.3 Orifice plate calculations shall be performed according to ISO 5167 requirements.

8.2.4 The orifice plates shall be flange pressure measurement – flange taps.

8.2.5 Drain hole shall not be used on the orifice plates. The separation of the undesired fluid shall be done online or with a drain in the plate support device.

8.2.6 β factor shall comply with I-ET-3010.00-1200-813-P4X-001 - GENERAL CRITERIA FOR FLOW METERING SYSTEMS. In case of divergence, Buyer shall be consulted.

8.2.7 Senior orifice fitting device shall be provided where indicated on P&IDs. Maintenance area and access shall be foreseen by detailed design and used as base for pipe design.

8.2.8 Orifice plates, both spare and the initial plates shall not be assembled in line until the conclusion of pipe cleaning. Until such time, these plates shall be stored in a proper room with controlled temperature and humidity.

8.2.9 Meter Tubes (Straight Pipe Runs)

	TECHNICAL SPECIFICATION	Nº I-ET-3010.2D-1200-800-P4X-005	REV. C
	AREA:	ATAPU 2 AND SÉPIA 2	SHEET 20 of 48
	TITLE:	FIELD INSTRUMENTATION	INTERNAL
			ESUP

8.2.9.1 Meter tubes shall be mounted between flanges (spools), and tags shall be FX and FY, according to I-ET-3000.00-1200-940-P4X-001 – TAGGING PROCEDURE FOR PRODUCTION UNITS DESIGN.

8.2.9.2 Meter tubes mechanical characteristics such as line schedule, etc. shall comply with the requirements of appropriate pressure class even after the finishing process of machining and polishing to adjust internal roughness. Test certificates in compliance with ISO standard (internal roughness, etc.) shall be issued and handed over upon delivery in order to allow complete tracking.

8.2.9.3 Upstream and downstream straight pipe runs that are part of a metering point shall have external identification with serial number.

8.2.10 A *zanker* flow conditioner shall be used in order to reduce requirements to the minimum straight length of the meter tube. Flow conditioner shall only be installed after conclusion of pipe cleaning.

8.3 Positive Displacement Flow Meters

8.3.1 Oval Gears Positive Displacement flow meter can be used for liquids of high and low viscosity. The instrument selection shall take into account manufacturer's recommendation for maximum flow rate for continuous service and viscosity rate class. Its construction with special gears teeth profiles and special materials shall be suitable for viscous fluids containing hard solid impurities (sand, etc) up to 2 % and Ø1 mm.

8.3.2 Positive Displacement flow meters shall be configured for 4-20 mA + HART signal output.

8.3.3 The Positive Displacement meter can be installed horizontally or vertically; when mounted vertically, flow shall be ascendant.

8.4 Mass (Coriolis) Flow Meters

8.4.1 Coriolis meters shall be configured for pulse signal output.

8.4.2 Coriolis meters may be installed either horizontally or vertically. The preferred installation is vertical with the flow up through the sensor and with the sensor at lowest point of the ascending pipe.

8.4.2.1 Coriolis meter shall be installed so that full drainage of tubes is feasible by means of gravity.

8.4.3 Coriolis meters shall not be used on liquid services where cavitation or flashing may occur.

8.4.4 Mass flow meters can also be used to provide density measurement from an additional output, but it shall be noted that this is not the primary function of the instrument and should be avoided.

	TECHNICAL SPECIFICATION	Nº I-ET-3010.2D-1200-800-P4X-005	REV. C
	AREA: ATAPU 2 AND SÉPIA 2	SHEET 21 of 48	
	TITLE: FIELD INSTRUMENTATION	INTERNAL ESUP	

8.5 Magnetic Flow Meters

- 8.5.1 Magnetic flow meters may be used for water applications and for corrosive or low pressure drop services.
- 8.5.2 To avoid any risk of damage to meter lining by vacuum, Magnetic flow meters shall not be installed on reciprocating pump suction lines.
- 8.5.3 Magnetic flow meters shall comply with ISO 20456 – MEASUREMENT OF FLUID FLOW IN CLOSED CONDUITS - GUIDANCE FOR THE USE OF ELECTROMAGNETIC FLOWMETERS FOR CONDUCTIVE LIQUIDS.

8.6 Ultrasonic Meters

- 8.6.1 Ultrasonic meters for liquid hydrocarbon applications shall take into account the maximum allowable viscosity and gas content in the liquid, as well as the fluid velocity
- 8.6.2 Ultrasonic meters for gas application shall be installed in such way that their sensors avoid contact with possible carried liquid/condensate.
- 8.6.3 Ultrasonic flow meters interconnected to CSS shall have 4-20 mA + HART output. Refer to I-ET-3010.00-1200-813-P4X-001 - GENERAL CRITERIA FOR FLOW METERING SYSTEMS for output requirements for flare gas measurement.

8.7 Cone Meters

- 8.7.1 The pressure taps shall be placed on the upper horizontal section of the pipe, between the 3 (three) or the 9 (nine) o'clock positions.

9 CONTROL VALVES

9.1 General Requirements

- 9.1.1 Sizing, body type, end to end dimensions, construction and actuators for all control valves to be installed at the FPSO shall comply with the requirements of I-ET-3010.2D-1200-200-P4X-001 – PIPING SPECIFICATION FOR TOPSIDES, I-ET-3010.2E-1200-200-P4X-001 – PIPING SPECIFICATION FOR HULL, and I-ET-3010.00-1200-800-P4X-013 – GENERAL CRITERIA FOR INSTRUMENTATION PROJECTS.
- 9.1.2 Control Valve (including self-actuated valves) material shall comply with I-ET-3010.2D-1200-200-P4X-001 – PIPING SPECIFICATION FOR TOPSIDES, Annex A and I-ET-3010.2E-1200-200-P4X-001 – PIPING SPECIFICATION FOR HULL, Annex A. In case a cage is necessary, solid tungsten carbide shall be used.

	TECHNICAL SPECIFICATION	Nº I-ET-3010.2D-1200-800-P4X-005	REV. C
	AREA:	ATAPU 2 AND SÉPIA 2	SHEET 22 of 48
	TITLE:	FIELD INSTRUMENTATION	INTERNAL
			ESUP
<p>9.1.3 Control Valve data sheets shall inform, for each valve, normal, minimum and maximum flowrates. Also, for each flowrate, it shall inform pressure, temperature and all other fluid data required for valve calculations (density, viscosity, molecular weight, specific heat ratio (Cp/Cv), compressibility factor etc).</p> <p>9.1.4 Control Valve manufacturers shall provide calculations sheets for each valve for all process conditions (normal, minimum and maximum), including actuator sizing, noise and flow velocity at the valves.</p> <p>9.1.5 Control valves that share both interlocking and control functions (i.e., control valves for utilities, with a solenoid and a position transmitter) shall have leakage class VI, according to ANSI FCI 70-2. Control valves directly connected to a line that discharges to flare shall have leakage class V, according to ANSI FCI 70-2 and shall be inspected and tested according to API STD 598. All other control valves shall have leakage class IV, according to ANSI FCI 70-2.</p> <p>9.1.6 Control valves shall be built and tested to prevent fugitive emissions according to ISO 15848 – INDUSTRIAL VALVES – MEASUREMENT TEST AND QUALIFICATION PROCEDURES FOR FUGITIVE EMISSIONS’ definitions: BH Tightness class and CC1 endurance class. For a list of control valves with such requirements, refer to I-MD-3010.2D-1200-940-P4X-011 - DESCRIPTIVE MEMORANDUM - AUTOMATION & CONTROL.</p> <p>9.2 Actuator</p> <p>9.2.1 The actuator housing material shall be painted carbon steel or stainless steel and shall be adequate to marine environment.</p> <p>9.2.2 The recommended valve actuator mounting position is vertical to the flow direction.</p> <p>9.2.3 Actuator sizing shall take into account the maximum differential pressure to which the valve is submitted.</p> <p>9.2.4 Actuators shall be sized so that normal throttling control is guaranteed under the minimum air supply pressure condition and that specified air failure position is achieved considering stated shut-off differential pressure. Electrical or piston driven actuators may be considered for special conditions and upon Buyer’s approval.</p> <p>9.2.5 A mechanical pointer and scale type travel indicator, directly coupled to the actuator, shall be provided for local indication of valve travel. Permanent marks for full open and full closed positions shall be provided at the travel limits.</p> <p>9.2.6 Actuator’s design shall be such that its bearing requires low lubrication and low intervention under marine atmosphere, such that the actuator output torque is capable of moving the valve throughout its whole travel.</p>			

	TECHNICAL SPECIFICATION	Nº I-ET-3010.2D-1200-800-P4X-005	REV. C
	AREA:	ATAPU 2 AND SÉPIA 2	SHEET 23 of 48
	TITLE:	FIELD INSTRUMENTATION	INTERNAL
			ESUP

9.3 Positioners

- 9.3.1 Positioners shall be electro-pneumatic, smart type, with 4 – 20 mA + HART (2 wires, 24 VDC) electronic signal. They shall be sized according to the volume of the actuator they are connected to.
- 9.3.2 All positioners shall feature 4-20mA position feedback output.
- 9.3.3 Positioners shall be calculated to assure a stroke time of 2 seconds per inch of the control valve or faster. Use of booster for fast action control loops can be considered and applied upon Buyer's approval.

9.4 Limit switches

- 9.4.1 When required, limit switches shall be of magnetic type (no moving parts).
- 9.4.2 Enclosures shall be hermetically sealed.
- 9.4.3 In-place no spark setpoint tuning shall be possible, without disassembling form valve body.
- 9.4.4 Limit switches shall withstand operation under 1A – 24 VDC condition.

9.5 Control Valves for Severe Service

- 9.5.1 Control valves for severe service shall be used according to the criteria described in I-ET-3010.00-1200-800-P4X-013 – GENERAL CRITERIA FOR INSTRUMENTATION PROJECTS.

10 CHOKE VALVES

10.1 General Requirements

- 10.1.1 Refer to I-ET-3010.00-1200-800-P4X-013 – GENERAL CRITERIA FOR INSTRUMENTATION PROJECTS for choke valves mandatory requirements. Also, the following aspects shall be complied with.
- 10.1.2 Choke valves installed at main production lines, between production risers and production/test manifolds, at water injection lines and at gas injection lines shall be pneumatic actuated with position transmitter. The actuation shall be done from the Topsides SOS HMIs through virtual hand switches.
- 10.1.2.1 Other choke valves installed at the platform shall be field operated, without any indication at Topsides SOS HMIs.
- 10.1.3 Choke valves shall be able to receive different cages in order to have different possible CVs in the same valve. These CVs shall be determined for all process conditions, so that in no case the choke needs to be positioned less than 20% of its travel.

	TECHNICAL SPECIFICATION	Nº I-ET-3010.2D-1200-800-P4X-005	REV. C
	AREA:	ATAPU 2 AND SÉPIA 2	SHEET 24 of 48
	TITLE:	FIELD INSTRUMENTATION	INTERNAL
			ESUP

- 10.1.4 Chokes' opening rate shall be programmed so as it never opens faster than a pre-established value, in order to avoid damage to the reservoir. For the definition of such value, PETROBRAS shall be consulted during Detailing Engineering Design.
- 10.1.5 Chokes shall be suitable to perform slug control.
- 10.1.6 For further details, see instrumentation diagram in the I-DE-3010.2D-1200-944-P4X-001 – GENERAL NOTES.
- 10.1.7 Choke Valves Actuator's design shall be such that its bearing requires low lubrication and low intervention under marine atmosphere, such that the actuator output torque is capable of moving the valve throughout its whole travel.

11 ON-OFF VALVES

11.1 General Requirements

- 11.1.1 Valve sizing, body type, valve construction, actuator sizing, actuation fluid, necessary accessories, installation requirements, interface with CSS and other features for all on-off valves (SDV, BDV, XV and ADV) to be installed at UNIT shall comply with I-ET-3010.2D-1200-200-P4X-001– PIPING SPECIFICATION FOR TOPSIDES, I-ET-3010.2E-1200-200-P4X-001 – PIPING SPECIFICATION FOR HULL, and I-ET-3010.00-1200-800-P4X-013 – GENERAL CRITERIA FOR INSTRUMENTATION PROJECTS.
- 11.1.2 Solenoid valve for on-off valve actuation shall be made of AISI 316 stainless steel and the power consumption shall be limited to 5W per valve for the solenoids connected to CSS I/O cards. Refer to I-ET-3010.00-1200-800-P4X-013 – GENERAL CRITERIA FOR INSTRUMENTATION PROJECTS other solenoid valves' requirements.
- 11.1.3 All on-off valve actuators (SDV, BDV, ADV and XV) shall be adequate to marine environment, made of painted carbon steel or stainless steel and their design shall be such that their bearing require low lubrication and low intervention under marine atmosphere, such that the actuator output torque is capable of moving the valve throughout its whole travel.
- 11.1.4 SDVs and XVs actuators shall preferably be pneumatically driven. For BDV, see item 11.3.2. Special cases shall be defined by detailed design documents. All actuators shall comply with ISO 12490.
- 11.1.5 For all non-piggable 600# (or greater) rated and with body size 10" (or greater), triple eccentric butterfly valve can be considered, provided that the pressure drop does not affect other process equipment.

	TECHNICAL SPECIFICATION	Nº I-ET-3010.2D-1200-800-P4X-005	REV. C
	AREA: ATAPU 2 AND SÉPIA 2	SHEET 25 of 48	
	TITLE: FIELD INSTRUMENTATION	INTERNAL	
		ESUP	

11.2 Shutdown Valves (SDV)

11.2.1 SDV data sheets shall clearly inform the required actuation time. SDV manufacturer shall inform the actual closing time for each valve, at operation conditions. Deviations of actual closing time from required closing time shall be submitted to PETROBRAS for approval.

11.2.2 All platform-limit SDVs (production, gas injection and water injection SDVs) shall have a Partial-Stroke Testing (PST) device.

11.2.2.1 PST shall be triggered by an additional solenoid.

11.2.2.2 PST duration shall be controllable by a local device, such as an inline needle valve at the pneumatic circuit.

11.3 Blowdown Valves (BDV)

11.3.1 Each BDV valve shall have 2 (two) check valves in series to keep the BDV closed in case of failure of air supply and 1 (one) air reservoir complying with NR-13 to ensure 1 (one) valve operation. For information on how this reservoir shall be sized, refer to I-ET-3010.00-1200-800-P4X-013 - GENERAL CRITERIA FOR INSTRUMENTATION PROJECTS.

11.3.2 BDVs shall be pneumatic-driven. Hydraulic-driven BDVs are not accepted.

11.3.3 BDV data sheet shall clearly inform the differential pressure to be considered at the valve to allow proper restriction orifice dimensioning, whenever required.

11.3.4 Mechanical temporization.

11.3.4.1 To avoid all BDVs to open simultaneously due to blackout scenario/common cause electric failure, each BDV classified in I-RL-3010.2D-1200-940-P4X-005 – RELIEF AND BLOWDOWN REPORT shall be supplied with a mechanical “Temporization Skid for Delaying BDV Opening” (TSDBO). This works as a backup for logic actuation, in order to determine a fixed period of time that BDV must still be kept closed, allowing it to open only when Flare would have capacity for BDV initial gas flow.

11.3.4.2 The mechanical temporization shall be based solely on pneumatic energy by using a volume to be depressurized from a controlled 4.9 barg to 2 barg, when the final pressure will actuate a pilot valve, depressurizing BDV’s actuator and opening the BDV.

11.3.4.3 The mechanical temporization skid shall be designed to receive three discrete electric signals. Two for open/close signal from CSS logic (BDY-1 and BDY-2). Other signal is a PLC/remote watchdog (KSY) this signal shall be kept active (24 Vdc) while the FGS system and remote I/O are running, if remote or FGS are down or off-line, (like all redundant CPU are stopped, or without power supply or full network failure on remote I/O, etc.) this signal shall be deactivated.

	TECHNICAL SPECIFICATION	Nº I-ET-3010.2D-1200-800-P4X-005	REV. C
	AREA:	ATAPU 2 AND SÉPIA 2	
	TITLE:	FIELD INSTRUMENTATION	SHEET 26 of 48
			INTERNAL
			ESUP

11.3.4.4 3-way solenoid valves are to be used in the TSDBO, two for the BDV itself (BDY-1 and BDY-2) and another to activate the temporization (KSY). Solenoid BDY-1 shall be energized to close BDV and solenoid KSY must be energized when temporization is not required. When only BDY-1 is de-energized, BDV shall be commanded to open immediately. When both BDY-1 and KSY are de-energized, BDV opening shall be delayed by mechanical temporization skid. If KSY is de-energized and BDY-1 remains energized, this indicated a logic error. In such case, the respective BDV shall remain closed and the situation shall be alarmed at SOS HMIs.

11.3.4.5 A set of pneumatic accumulators shall be used to retain a volume at 4.9 barg. When a blackout occurs, KSY is activated and the accumulated air will be vented through a calibrated orifice of a metering valve adjusted to make the accumulator pressure to drop from 4.9 barg to 2 barg in the period of time specified for the BDV to open. When pressure reaches 2 barg a piloted valve is commanded, aligning BDV actuator to atmosphere, which starts BDV opening. A schematic of the effect of each valve in BDV state is shown in Figure 2.

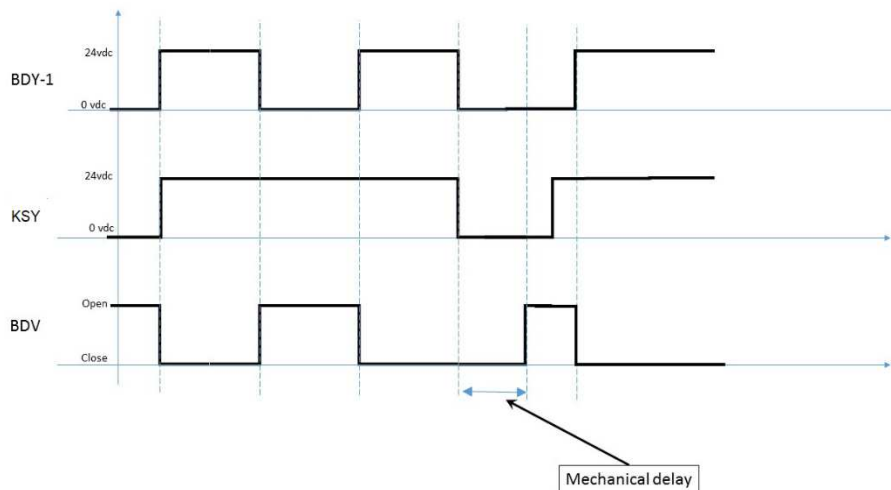

Figure 2 - Solenoids effect on BDV

11.3.4.6 The second solenoid, BDY-2, shall also be provided, in order to allow the actuation of the BDV in case of failure of the KSY, avoiding, in that case, the mechanical temporization. Its failure mode shall be the opposite of BDY-1, i.e., to open the BDV through BDY-2, BDY-2 shall be energized.

11.3.4.7 For further details, refer to I-DE-3010.2D-1200-944-P4X-001 – GENERAL NOTES and I-ET-3010.00-1200-800-P4X-013 – GENERAL CRITERIA FOR INSTRUMENTATION PROJECTS.

11.4 Automatic Deluge Valves (ADV)

11.4.1 All ADVs shall be supplied in individual skids, each skid comprised of the following items:

- 1 (one) ADV with actuator, with 2 (two) position limit switches for ADV status monitoring and 1 (one) quick exhaust device to minimize actuator venting time (this quick exhaust shall be supplied along with ADV actuator):

	TECHNICAL SPECIFICATION	Nº I-ET-3010.2D-1200-800-P4X-005	REV. C
	AREA:	ATAPU 2 AND SÉPIA 2	SHEET 27 of 48
	TITLE:	FIELD INSTRUMENTATION	INTERNAL
			ESUP

- 1 (one) by-pass valve;
- 1 (one) valve for drain and flushing connection.

NOTE 1: Remote Manual / Automatic Operation

The manual/automatic opening of deluge valves through/by Topsides SOS HMIs shall be through “energize to open” type signal. Refer to DR-ENGP-M-I-1.3– SAFETY ENGINEERING for other requirements for ADVs’ remote manual/automatic operation

NOTE 2: Each Automatic Deluge Valve (ADV) for water system or foam system shall be provided with a dedicated ADV local panel, installed as close as possible to ADV skid. Each ADV local panel and its associated instrumentation accessories shall be hardwired connected to CSS Topsides Remote I/O Panel installed at AEPR on Module M-17, by means of fire-resistant cables.

For further details, see item 16 below, I-DE-3010.2D-1200-944-P4X-001 – GENERAL NOTES and I-ET-3010.00-1200-800-P4X-013 – GENERAL CRITERIA FOR INSTRUMENTATION PROJECTS.

- 11.4.2 ADVs, when actuated by depressurization of fusible plugs’ network, shall be fully opened within 45s from fusible plug melting (refer to DR-ENGP-M-I-1.3– SAFETY ENGINEERING).
- 11.4.3 After local or remote actuation, the ADV shall remain open until closing is locally commanded by operator.
- 11.4.4 These valves shall be certified and approved by recognized institutions for offshore application.
- 11.4.5 Additional requirements (such as fire testing) for ADVs and their accessories shall be evaluated during detailed design phase, considering Classification Society requirements and safety studies.

12 SAFETY RELIEF VALVES (PSV)

12.1 General Requirements

- 12.1.1 Refer to I-ET-3010.00-1200-800-P4X-013 – GENERAL CRITERIA FOR INSTRUMENTATION PROJECTS for sizing, installation and material selection guidelines. Also, the following requirements shall be complied with.
- 12.1.2 Balanced bellows valve design shall be considered for variable backpressures or when backpressure exceeds 10 % of the set pressure. Also, by recommended practice, balanced bellows shall be applied when PSV operates in services with toxic or corrosive fluids.

	TECHNICAL SPECIFICATION	Nº I-ET-3010.2D-1200-800-P4X-005	REV. C
	AREA:	ATAPU 2 AND SÉPIA 2	SHEET 28 of 48
	TITLE:	FIELD INSTRUMENTATION	INTERNAL
			ESUP

12.1.3 Pilot operated valves may be considered for high pressures, when backpressure exceeds 50% of the set pressure or where operating pressures are close to the set pressure or narrow blow down is required. Design shall ensure that the main valve will continue to operate and relieve the required capacity even if the pilot valve fails. The use of pilot-operated valves requires PETROBRAS formal approval.

12.1.4 Selected PSVs shall be flexible so as to allow replacement of parts on site in order to:

- replace a standard trim to balanced bellows type and vice-versa;
- replace original nozzle type to a different orifice for a given body size.

12.1.5 All PSVs shall be foreseen with a threaded stem with sufficient stem length in order to allow for the online testing of the PSV. The PSVs placement in the 3D model shall have enough space above the valve in order to allow for the online testing equipment to be inserted.

13 ANALYZERS

13.1 General Requirements

13.1.1 Analyzers with sensing probes mounted into the process shall be provided with isolation and bypass valves for ease of maintenance. Casings or enclosures shall be ASTM A351 GR CF8M stainless steel made (AISI-316). Deviations shall be submitted to Buyer for approval.

13.1.2 Where required, suitable upstream sample conditioning and sample transportation system shall be designed and installed to provide sample to analyzer specifications. Sample conditioning and transportation system shall be installed on a self-standing panel (AISI 316L stainless steel). Samples shall be returned to the process as far as possible instead of venting or draining. When used, block valves shall be double block and bleed type. Sample systems shall avoid dead legs.

13.1.3 Panels installed in open areas (outdoors) shall be designed for IP-56 protection degree according to IEC-60529, shall be purged and pressurized according to NFPA 496 and IEC 60079-2 ("Z" pressurization type) and shall comply with the area classification requirements.

13.1.4 Analyzer units shall be smart microprocessor type. 4-20 mA analogue output signal shall be provided for sending the analyzed variable data to CSS (PCS system).

13.1.4.1 Analyzers shall feature self-diagnostics tools. Digital output signals (voltage-free contact) shall be used for remote indication of analyzer malfunction and emergency stop.

	TECHNICAL SPECIFICATION	Nº I-ET-3010.2D-1200-800-P4X-005	REV. C
	AREA:	ATAPU 2 AND SÉPIA 2	SHEET 29 of 48
	TITLE:	FIELD INSTRUMENTATION	INTERNAL
			ESUP

13.1.4.2 HART protocol is required for detailed diagnostics and remote configuration. Other digital protocols such as Modbus RTU can be used, as long the 4-20mA is still available and connected to CSS.

13.1.4.3 Local alphanumeric display showing the instant measured value is required.

13.1.5 When applicable, the sampling system and all required accessories (such as, but not limited to: sampler pumps, fast loops, thermal insulation, filters, pressure regulator valves, air dryers) shall be supplied totally mounted and tested. All internal materials shall be, at least, AISI 316 stainless steel. Material for Tubings and Fittings used in sampling system shall also comply with I-ET-3010.00-1200-800-P4X-015 - REQUIREMENTS FOR TUBING AND FITTING (ALIGNED TO IOGP-JIP33 S-716)

13.1.6 If the analyzer has a probe, detailed design shall grant the necessary clearance and access to perform probe extraction and reinsertion. These methods shall thoroughly be detailed in the documentation.

13.1.7 Power supply shall comply with I-ET-3010.00-5140-700-P4X-003 – ELECTRICAL REQUIREMENTS FOR PACKAGES FOR OFFSHORE UNITS.

13.1.8 It shall be foreseen available space and access for maintenance/calibration around analyzer according to Manufacturer requirement/recommendation during operation phase.

13.1.9 Analyzers that need to discard any fluid during its operation, Seller shall foresee manners to direct this fluid to the correct drain system.

13.1.10 Analyzers shall be designed and supplied with all the resources needed for onboard calibration and commissioning.

13.1.11 Manufacturers shall have technical support infrastructure in Brazil.

13.2 Water in Oil Analyzers (BS&W)

13.2.1 The selection of technology to be used shall take into account the water in oil range required as well fluid characteristics, according to I-ET-3010.00-1200-813-P4X-001 - GENERAL CRITERIA FOR FLOW METERING SYSTEMS.

13.3 Oil-in-Water Analyzers (TOG)

13.3.1 Oil-in-Water rates shall be automatically and continuously monitored by means of ultraviolet (UV) fluorescence technology analyzers, which shall have automatic self-cleaning capability by means of ultrasonic (acoustic) method.

13.3.1.1 In the only case that oil phase of the water to be monitored is exclusively gas condensate, light scatter technology can be used.

13.3.2 TOG for discharge water applications shall comply with Classification Society requirements.

	TECHNICAL SPECIFICATION	Nº I-ET-3010.2D-1200-800-P4X-005	REV. C
	AREA:	ATAPU 2 AND SÉPIA 2	SHEET 30 of 48
	TITLE:	FIELD INSTRUMENTATION	INTERNAL
			ESUP

- 13.3.3 Automatic cleaning system shall be able to operate over the full operating range of the process; when the process is subject to sudden drops in pressure and flow, which may result in extended wear of the windows, an input of these process parameters shall be available to switch off the cleaning process while these conditions are present.
- 13.3.4 All sample wetted parts shall be corrosion resistant in accordance with fluid process conditions.
- 13.3.5 The sampling point shall preferably be in an ascending flow pipe run in order to avoid possible interference from the phase stratification, commonly observed in horizontal multi-phase flows, and more than one point can be monitored from a single analyzer. The intrusive point shall be installed in the center of the pipe, in a 90 degree orientation against the flow.
- 13.3.6 If sampling is carried out by in line probe, proper maintenance and calibration clearance shall be granted by design, observing the ergonomics required by these activities.
- 13.3.7 Manual sampler shall be provided for each TOG analysis point at the process line.
- 13.3.8 If sample conditioning is necessary for proper operation, all necessary accessories to provide pressure, temperature, flow rate and phase adjustments in order to make the sample compatible with the analyzer shall be designed and supplied.
- 13.3.8.1 Samples shall be representative, continuous and shall comply with the following requirements:
- Sample shall not contain solids: suspended solid content < 20 mg/l;
 - Sample shall not contain free gas;
 - Should total iron content be greater than 2.0 mg/l, an acid cleaning system shall be provided;
 - Flow rate, pressure and temperature of the sample shall also be adjusted for the equipment's operating limits.
- 13.3.8.2 If Process conditions require a pump to guarantee adequate flow rate during sampling, this pump shall also be supplied. Technical specifications for this pump shall be submitted to PETROBRAS for approval.
- 13.3.8.3 If probe is installed in a tank, the pump shall be installed on the main deck. Seller shall install a check valve on the suction line of the pump and verify the appropriate position of the check valve, in accordance with the maximum suction lift of the pump.
- 13.3.9 By-pass arrangement shall only be used in cases where high variation on types of oils and grease at the process line is expected and upon PETROBRAS approval.

	TECHNICAL SPECIFICATION	Nº	I-ET-3010.2D-1200-800-P4X-005	REV.	C	
	AREA:	ATAPU 2 AND SÉPIA 2			SHEET	31 of 48
	TITLE:	FIELD INSTRUMENTATION			INTERNAL	
					ESUP	

13.3.10 Whenever the sample need to be returned to a closed drain, then system counter-pressure shall be considered in order to avoid damaging the analyzer pressurizing system.

13.3.11 Monitor/analyzer maintenance shall be possible of being carried out onboard.

13.3.12 If it is required to install TOG analyzer at a disposal point at the outlet of vessel tanks where open drainage water is present (i.e. slop discharge system), the analyzer shall comply with IMO MEPC 107(49) and 108.

13.3.13 TOG analyzer shall have a local screen capable of indicating the variables measured in engineering units, viewing, and entering configuration and calibration parameters and showing alarm and fault history.

13.3.14 TOG analyzer shall be supplied with all the resources needed for calibration.

13.3.15 TOG analyzer shall have a local “on/off” pushbutton.

13.3.16 TOG analyzer shall be of the smart microprocessor type, with analogue signal 4-20 mA + HART for output.

13.3.17 Side-stream mounted TOG analyzers shall have an automatic shut-off valve on analyzer’s inlet.

13.3.18 In an ESD-2 condition, all analyzers shall be turned off, but kept with fluid inside them.

13.3.19 Spare instruments shall be foreseen to the following oil in water analyzers:

- Analyzer between Gas Flotation Unit and Produced Water Tanks
- Analyzer between Produced Water Pumps and Produced Water Filters

13.3.20 All infrastructure required by the spare analyzers, including, but not limited to, sampling conditioning, probes, cables, junction boxes and I/O points interconnection on Remote Panel shall be furnished and assembled. The spare analyzers, however, shall be furnished and kept dismantled in a warehouse.

13.4 Oxygen Analyzer

13.4.1 Oxygen analyzer shall be TDLAS type in gas measurement. The use of advanced thermoparamagnetic type for gas measurement may be considered upon Buyer’s approval. For liquid measurement shall be applied amperometric sensor type. Instrument accuracy shall be better than $\pm 1\%$ of full scale and repeatability of $\pm 0.2\%$ of span. Oxygen concentration shall be continuously and automatically monitored.

13.4.2 Analyzers sample system shall be provided with all necessary accessories for local flow indications (rotameter, needle valves, pressure gauges, etc).

	TECHNICAL SPECIFICATION	Nº	I-ET-3010.2D-1200-800-P4X-005	REV.	C	
	AREA:	ATAPU 2 AND SÉPIA 2			SHEET	32 of 48
	TITLE:	FIELD INSTRUMENTATION			INTERNAL	
					ESUP	

- 13.4.3 Instruments shall be supplied with all necessary accessories for operation and maintenance (block valves, pressure regulating valves, sensors, vent, drain, etc).
- 13.4.4 Maximum response time shall be 20 seconds for control/monitoring applications and 10 seconds for interlocking purposes.
- 13.4.5 When nitrogen purge is required by the manufacturer, the TDLAS analyzer shall have its purging N₂ unit connected to the main nitrogen distribution system. The analyzer shall function correctly with the nitrogen content provide (N₂ > 95% purity).

13.5 Oxygen Analyzer for corrosion monitoring

- 13.5.1 Due to the presence of HC Blanketing System in the FPSO, some residual O₂ may be recirculated in the process plant. In order to detect the presence of this residual O₂, and to monitor the corrosion that the lines are subjected to, Oxygen Analyzers for corrosion monitoring shall be foreseen in the plant. Oxygen concentration shall be continuously and automatically monitored.
- 13.5.2 The monitoring point shall be as established at P&IDs.
- 13.5.3 Oxygen analyzer shall be preferably of TDLAS type. This oxygen analyzer shall be able to have a sensitivity as low as 1ppm. Exceptionally, optical quench luminescence technology may be used.
- 13.5.4 Analyzers sample system shall be provided with all necessary accessories for local flow indications (rotameter, needle valves, pressure gauges, etc).
- 13.5.5 Instruments shall be supplied with all necessary accessories for operation and maintenance (block valves, pressure regulating valves, sensors, vent, drain, etc).
- 13.5.6 When nitrogen purge is required by the manufacturer, the TDLAS analyzer shall have its purging N₂ unit connected to the main nitrogen distribution system. The analyzer shall function correctly with the nitrogen content provide (N₂ > 95% purity).

13.6 Salinity Analyzer

- 13.6.1 Salinity analyzer shall be microwave absorption cell type. Instrument accuracy shall be better than 2% of the span.
- 13.6.2 Instruments shall be supplied with all necessary accessories for operation as: block valves, pressure regulating valves, sensors, vent, drain, etc.

13.7 Moisture Analyzer

- 13.7.1 Moisture analyzer shall be quartz crystal type or Tunable diode laser absorption spectroscopy (TDLAS). The probe shall incorporate moisture, temperature and pressure sensing elements. The electronic module shall transmit these signals to the analyzer transmitter unit.

	TECHNICAL SPECIFICATION	Nº I-ET-3010.2D-1200-800-P4X-005	REV. C
	AREA:	ATAPU 2 AND SÉPIA 2	SHEET 33 of 48
	TITLE:	FIELD INSTRUMENTATION	INTERNAL
			ESUP

- 13.7.2 The analyzer/transmitter shall continuously self-check and also check the probe, and signal transmission. Temperature and pressure influence in the moisture measurement shall be continuously compensated.
- 13.7.3 Sample collecting point shall comply with API MPMS 14.1 standard. Gas sample shall be discharged to the venting system.
- 13.7.4 Analyzer sample system shall be provided with all necessary accessories including heat tracing in order to avoid sample freezing.
- 13.7.5 Instrument uncertainty shall be less than 5 % of span.
- 13.7.6 Analyzer shall be supplied with calibrating kit with certified N2 cylinder (super dry) with known dew point. The use of correction factor and its specification shall be according to ASTM 1142/95 standard.
- 13.7.7 Instruments shall be supplied with all necessary accessories for operation/installation as: block valves, pressure regulating valves, interconnecting cables, adapters, sensors fixing brackets and supports, etc.

13.8 Dew point Analyzer

- 13.8.1 Dew point analyzer shall be of high capacitive type with ultra-thin aluminum oxide sensor material and ceramic based.
- 13.8.2 Analyzer sample system shall be provided with all necessary accessories including heat tracing in order to avoid sample freezing.
- 13.8.3 The analyzer/transmitter shall continuously self-check and also check the probe, and signal transmission. Temperature and pressure influence in the moisture measurement shall be continuously compensated.
- 13.8.4 The analyzer shall have self-diagnostic capability.
- 13.8.5 Analyzer shall be certified at vibration interferences according to IEC 60068-2-64 test Fh and IEC 60068-2-27 Test Ea.
- 13.8.6 Analyzer shall withstand operation measurement pressure at least of 206 barg.
- 13.8.7 All gas-wetted parts shall be in stainless steel (AISI 316L grade) with viton soft parts.
- 13.8.8 The gas sampling shall be discharged to UNIT's venting system.
- 13.8.9 Instrument accuracy shall be less than +/-2 % of the span.
- 13.8.10 Instruments shall be supplied with all necessary accessories for operation/installation (block valves, pressure regulating valves, interconnecting cables, adapters, sensors fixing brackets and supports, etc).

	TECHNICAL SPECIFICATION	Nº I-ET-3010.2D-1200-800-P4X-005	REV. C
	AREA:	ATAPU 2 AND SÉPIA 2	
	TITLE:	FIELD INSTRUMENTATION	SHEET 34 of 48
			INTERNAL
			ESUP

13.8.11 The sample system shall have glycol absorption cartridge filter, used on natural gas systems only.

13.8.12 The analyzer shall be provided with temperature control in order to reduce the effects of diurnal (day-night) swings in temperature and prevent measurement errors during periods of temperature change.

13.8.13 Sample system shall be provided with gas purge system. Sample system shall be de-pressurized for maintenance.

13.8.14 Analyzer shall feature natural gas moisture content calculations based on either ISO 18453 or IGT Research Bulletin nº 8.

13.9 CO₂ Analyzer

13.9.1 CO₂ analyzer shall be Tunable Diode Laser (TDL) or Non-dispersive Infrared (NDIR). Other detection method without moving parts, nor consumables are also accepted.

13.9.2 CO₂ analyzer shall be mounted directly onto measurement cells or DN50/ANSI 2" flanges.

13.9.3 Measurements shall be performed in real-time.

13.10 H₂S Analyzer

13.10.1 H₂S analyzer shall be ultraviolet-visible (UV-Vis) or Tunable Diode Laser (TDL) type. Instrument sensitivity shall be better than 1% full scale. Response time shall be 90% in less than 30 seconds. H₂S concentration shall be continuously and automatically monitored.

13.10.2 Analyzers sample system shall be provided with all necessary accessories to provide pressure, temperature, flow rate and phase adjustments in order to make the sample compatible with the analyzer.

13.10.3 Instruments shall be supplied with all necessary accessories for operation, maintenance and proper cleaning/flushing of the entire system.

13.11 Chlorine Analyzer

13.11.1 Chlorine analyzer shall be amperometric membrane using electrodes to provide a continuous online measurement of residual chlorine concentration.

13.11.2 Chlorine analyzer accuracy shall be better than +/- 0,1 ppm, repeatability better than 2% full scale and response time better than 2 minutes per sample.

13.11.3 Chlorine analyzer power supply shall be 24 VDC.

	TECHNICAL SPECIFICATION	Nº I-ET-3010.2D-1200-800-P4X-005	REV. C
	AREA:	ATAPU 2 AND SÉPIA 2	
	TITLE:	FIELD INSTRUMENTATION	
		SHEET 35 of 48 INTERNAL ESUP	

13.12 Gas Chromatograph

13.12.1 Gas chromatograph system shall comprise: sampling system, sample conditioning system, auxiliary equipment, and accessories, as required to monitor the process stream and to provide the necessary data for the proper process operation. All the related services as technical and engineering, assembly, commissioning, start-up, pre-operation, and training shall be included. The analyzer shall be mounted in the field in a stainless steel cabinet to protect the analyzer, as near as possible of the sampling system.

13.12.2 The sampling system shall be installed in a dedicated AISI 316L panel. Sampling systems inside the analyzer panel shall not be acceptable.

13.12.3 Gas chromatograph shall quantify the concentrations of the main components in the gas composition for the purpose of gas accounting, calculation of calorific value and reference density in fiscal applications. The gas composition shall also be used for check of gas quality conformity with ANP gas quality specifications and as base for calculation of the operating density. Gas chromatograph shall be provided in accordance with the fluid composition, and fluid contaminants. Fluid composition shall be defined by SELLER during Detailed Engineering Design phase and shall be sent along with chromatograph's Material Requisition.

13.12.4 Gas chromatograph type shall be Thermal Conductivity Detector.

13.12.5 Analyzer shall comply with the following requirements.

- The analysis section enclosure shall be separated of the electronic unit enclosure;
- The analysis section shall have 2 (two) columns of the micro packaged type;
- Column material shall be in stainless steel with minimum 6 (six) months life duration under normal operation;
- If column switching is required, 2 (two) detectors shall be supplied;
- Analyzer shall have the capability of storing chromatograms in memory for future call up and reference.

13.12.6 Chromatograph controller shall control all the sampling system operation. All program data tables shall locally and remotely (at CCR) configurable.

13.12.7 The chromatograph software and license shall be foreseen to perform the calibration, operation and maintenance through engineering workstation.

13.12.8 Standard calibration gas and carrier gas cylinders shall be supplied, including all regulator valves and standard connector as well.

13.12.8.1 Cylinders shall be supplied in quantity necessary for commissioning, Plant Acceptance Test and Performance Test (Availability, Validation and Stability). The due date of the cylinders shall respect the dates for each of these tests.

13.12.8.2 Cylinders shall be supplied so as to allow 1 (one) calibration per week during 4 (four) months after acceptance. At least 2 (two) cylinders per standard shall be supplied.

	TECHNICAL SPECIFICATION	Nº I-ET-3010.2D-1200-800-P4X-005	REV. C
	AREA: ATAPU 2 AND SÉPIA 2	SHEET 36 of 48	
	TITLE: FIELD INSTRUMENTATION	INTERNAL	
		ESUP	

13.12.8.3 All calibration standards shall be valid for at least 6 (six) months after the plant start-up.

13.12.8.4 Helium gas purity shall be at least 99.999%.

13.12.9 The analysis time of each stream shall be shorter than 10 minutes. Response time of each stream (fast loop + analyzer cycle time) shall be short as soon as possible. Response time for each stream is the period between 2 (two) consecutive analyzer results.

13.12.10 The communication protocol shall be Modbus TCP.

13.12.10.1 All chromatographs shall be interconnected to Package Unit LAN. Any media and protocol converters (UTP to fiber and vice versa) shall be supplied and installed at the field (inside the chromatograph's panel) and at EOCP panels. Chromatographs shall be available for maintenance and calibration using the engineering workstation. The chromatograph's software shall also be installed at the engineering workstation.

13.12.11 Chromatographs shall provide the following information:

- Analyzer identification;
- Stream identification;
- Component identification;
- Concentration;
- Date (dd/mm/yy);
- Time (hh:mm:ss);
- All active alarms;
- Analysis validation (if available): Good / Not Good;
- Diagnostic: Initialization / Online;
- Calibration: Auto / Manual;
- Maintenance: On / Off
- Service: In / Out;
- End of Analysis: Normal / Abnormal
- Stream ID: Tag

13.12.12 Self-Diagnostics

13.12.12.1 Analyzer shall provide quality information on measured values, such as "good / not good" (on-line and off-line diagnostics).

13.12.12.2 Automatic diagnostics routine shall be executed on initialization, checking: CPU, memory, A/D module, clock, communication interfaces and controller boards.

13.12.12.3 The manual diagnostic function shall be activated by operator for: CPU, memory, A/D module, communication interfaces and force outputs to specific value.

	TECHNICAL SPECIFICATION	Nº I-ET-3010.2D-1200-800-P4X-005	REV. C
	AREA:	ATAPU 2 AND SÉPIA 2	
	TITLE:	FIELD INSTRUMENTATION	
		SHEET 37 of 48 INTERNAL ESUP	

13.12.13 Power supply shall be according to I-ET-3010.00-5140-700-P4X-003 - ELECTRICAL REQUIREMENTS FOR PACKAGES FOR OFFSHORE UNITS.

13.12.14 Gas Chromatographs supplied shall comply with all legal requirements and ANP standards.

13.13 PH Analyzer

13.13.1 PH analyzer shall be electromechanical type with electrode sensor.

13.13.2 Analyzer sample system shall be provided with all necessary accessories for operation, maintenance and cleaning of the entire system such as: transmitter, sensors, block valves, needle valves, rotameter, pressure regulating valves, interconnecting cables, adapters, connectors, drain system, fixing brackets and supports, flushing devices and others.

13.13.3 Instrument accuracy shall be better than $\pm 1\%$ of full scale.

13.13.4 PH analyzer shall be supplied with temperature compensation and calibration functionality.

13.13.5 If required, the sample conditioning shall be provided with all necessary accessories to provide pressure, temperature, flow rate and phase adjustments to make the sample compatible with the analyzer.

13.14 Density meters

13.14.1 Density elements shall be based on resonant principle.

13.14.2 Density transmitters output shall be 4 - 20 mA + HART.

14 REQUIREMENTS FOR SPECIFICATION OF SAFETY INSTRUMENTS

14.1 Gas Detectors

14.1.1 General Requirements

14.1.1.1 Gas detectors shall be type approved and installed according to DR-ENGP-M-I-1.3 – SAFETY ENGINEERING and Safety Studies requirements.

14.1.1.2 Gas detectors shall comply with all general and specific requirements listed in I-ET-3010.00-1200-800-P4X-013 - GENERAL CRITERIA FOR INSTRUMENTATION PROJECTS.

14.1.1.3 All Gas Detectors, except those integrating AFDS, shall be linked to CSS – FGS (Topsides Detectors) or CSS-HFGS (Hull Detectors), where voting logics and diagnosis shall be carried out.

	TECHNICAL SPECIFICATION	Nº I-ET-3010.2D-1200-800-P4X-005	REV. C
	AREA:	ATAPU 2 AND SÉPIA 2	SHEET 38 of 48
	TITLE:	FIELD INSTRUMENTATION	INTERNAL
			ESUP

14.1.1.4 The instrument output shall be 4-20 mA + HART. HART shall be the main remote faults and warnings' diagnostics and configuration protocol. 0 to 4 mA range can also be used for faults and warnings' indication, as long as every detector has functional HART communication and diagnostic current levels are different from those indicating general fault or absent instrument.

14.1.1.5 All gas detectors of the same type shall be of the same manufacturer.

14.1.1.6 Each gas detector shall be provided with resources to allow calibration without opening its enclosure and shall have protection against outside elements such as rain, dust, water spray etc. Proper accessories shall be provided, including the ones for gas detectors mounting/installation. Gas calibration kits shall be provided in a sufficient quantity for testing each gas detector during commissioning and pre-operation phases.

14.1.1.7 All detectors shall be marine approved and approved by Classification Society.

14.1.1.8 All material and hook-up associated to the installation of gas detectors (O₂ gas detectors, hydrogen gas detectors, CO₂ gas detectors, open path combustible gas detectors and point combustible gas detectors, open path toxic gas detectors and point toxic gas detectors) such as cables, ladders, supports, among others, shall be provided.

14.1.1.9 Open Path detectors location and hook-up shall comply with the following requirements.

- shall not be hooked up to structures subjected to high vibration nor water droplets;
- shall be hooked up to a flat plate, to be welded or bolted directly to the structure; 'U' type clamps shall not be used;
- shall not have the beam crossing permanently congested areas, such as piping, equipment, structures etc;
- 3D modeling shall consider a cylinder between Transmitter (Tx) and Receiver (Rx) so that no clash happens between the beam and other structures/piping.
- shall be installed so that the vertical clearance between the beam and any areas subjected to people's circulation is no less than 2,5 meters; hooking up over areas subjected to circulation of people, such as escape routes, shall be avoided;
- shall be installed so that parallel beams among two or more Transmitter (Tx) and Receiver (Rx) pairs do not interfere with each other, observing at least the following strategies: (1) parallel beams shall be at least 1m distant from each other; (2) Tx and Rx locations shall be alternated so that Tx from one pair cannot interfere with Rx of the closest parallel pair (anti-parallel assembly);
- shall be installed so that the distance between Tx and Rx does not exceed 90% of the maximum recommended distance according the manufacturer for the selected model, or does not exceed 40 meters, whichever is the least.

	TECHNICAL SPECIFICATION	Nº I-ET-3010.2D-1200-800-P4X-005	REV. C
	AREA:	ATAPU 2 AND SÉPIA 2	SHEET 39 of 48
	TITLE:	FIELD INSTRUMENTATION	INTERNAL
			ESUP

- shall have the presence of the beam properly signaled by: (1) a line painted on the floor right below, mimicking the projection of the beam; (2) a rope (or the like) linking Tx and Rx hook up supports and (3) a sign fixed in a visible position close to the beam.

14.1.1.10 All detectors shall be supplied with all necessary tools to installation, configuration and calibration.

14.1.1.11 Access for maintenance shall be foreseen during Detail design.

14.1.1.12 Contractor and gas detector manufacturer shall issue during Detailed Engineering Design phase the Parameters List for each type of detector including the setting of all parameters to guarantee the detector performance (detection / diagnostic) and comply with the requirements described on Safety studies and others design documents.

14.1.2 Combustible, O₂ and CO₂ Gas Detectors

14.1.2.1 Combustible gas detectors (point or open path), O₂ gas detectors and CO₂ gas detectors technology and applications shall comply with DR-ENGP-M-I-1.3 – SAFETY ENGINEERING definitions.

14.1.2.2 Combustible, O₂ and CO₂ gas detectors shall be suitable for operation in “Zone 2, Group IIA, T3” hazardous areas, as a minimum. CO₂ gas detectors shall be withstand temperatures as low as – 20°C.

14.1.2.3 The main characteristics of the IR point flammable gas detectors are:

- Detection principle: Infra-red absorption by hydrocarbon gases;
- Range of detection: 0 to 100 % LEL;
- Accuracy: +/- 5% FULL SCALE (@ 25°C);
- Analogue signal 4-20 mA + HART to include 0 – 100 %LEL signal and faults;
- Temperature range shall be –55°C to +75°C;
- Ingress protection IP56;
- Performance certificate and type approval certificate by international agency body, both for sensor and transmitter;
- Equipped with automatic self-testing features of electronics and optical integrity.

14.1.2.4 The main characteristics of the open path IR flammable gas detectors are:

- Detection principle: Infra-red absorption by hydrocarbon gases;
- Each detector includes an IR Source and a Receiver (detector with mirror is not acceptable);
- Range of detection: 0 to 5 LEL.m;
- Path length: 5 to 120 meters;
- Analogue signal 4-20 mA + HART to include 0 – 5 LEL.m signal and faults;
- Temperature range shall be –40°C to +60°C;
- Ingress protection IP56;
- Performance certificate and type approval certificate by international agency body, both for sensor and transmitter.

	TECHNICAL SPECIFICATION	Nº I-ET-3010.2D-1200-800-P4X-005	REV. C
	AREA:	ATAPU 2 AND SÉPIA 2	SHEET 40 of 48
	TITLE:	FIELD INSTRUMENTATION	INTERNAL
			ESUP

14.1.3 Toxic Gas Detectors

14.1.3.1 Toxic gas detectors technology and applications shall comply with DR-ENGP-M-I-1.3 – SAFETY ENGINEERING definitions. These detectors shall be suitable for operation in “Zone 1, Group IIB + H2, T1” hazardous areas.

14.1.4 Hydrogen Gas Detectors

14.1.4.1 Hydrogen gas detectors technology and applications shall comply with DR-ENGP-M-I-1.3 – SAFETY ENGINEERING definitions. These detectors shall be suitable for operation in “Zone 1, Group IIB + H2, T1” hazardous areas.

14.2 Flame Detectors

14.2.1 Flame detectors shall be type approved and in full compliance with DR-ENGP-M-I-1.3 – SAFETY ENGINEERING and Safety Studies’ requirements.

14.2.2 Flame detectors shall comply with all general and specific requirements listed in I-ET-3010.00-1200-800-P4X-013 - GENERAL CRITERIA FOR INSTRUMENTATION PROJECTS.

14.2.3 The instrument output shall be 4-20 mA + HART. HART shall be the main remote faults and warnings’ diagnostics and configuration protocol. 0 to 4 mA range can also be used for faults and warnings’ indication, as long as every detector has functional HART communication and diagnostic current levels are different from those indicating general fault or absent instrument.

14.2.4 Easy access to clean up the lenses shall be provided. 2 (two) test devices, from the same manufacturer of the detectors, shall be supplied.

14.2.5 Flame detectors shall have effective algorithms to prevent false alarms induced by welding, lightning, x-rays, sparks, lightning, lamps (sodium vapor, fluorescent, LED etc) and sunlight. Protection accessories against rain and excessive heat shall be provided to flame detectors installed in open areas.

14.2.6 Flame detectors’ allocation and hook up:

14.2.6.1 Allocation of flame detectors shall strictly comply with DR-ENGP-M-I-1.3 – SAFETY ENGINEERING and Safety Studies’ requirements.

14.2.6.2 In case optical flame detectors are allocated at top decks of the modules and other areas with straight field of view of flare stack or subject to sensitizing by reflections, special care shall be taken when design and executing detectors’ hook up and orientation. Positioning Flame detectors shall take into account flare position to minimize detections of flare, either directly or by reflection.

14.2.6.3 Protection accessories against sunlight and high flame flare shall be provided to the flame detectors installed in areas subjected to direct or reflected IR radiation. Painting of reflective surfaces can be considered as a means to mitigate reflections.

	TECHNICAL SPECIFICATION	Nº I-ET-3010.2D-1200-800-P4X-005	REV. C
	AREA: ATAPU 2 AND SÉPIA 2	SHEET 41 of 48	
	TITLE: FIELD INSTRUMENTATION	INTERNAL ESUP	

- 14.2.7 Proper installation accessories, such as mounting bracket/support and similar, shall be provided. Mounting brackets/Supports shall have vertical and horizontal orientation indication for assembly reference. Assembly on spots subject to high vibration shall be avoided.
- 14.2.8 All material and hook-up associated to the installation of flame detectors such as cables, ladders, supports, among others shall be provided.
- 14.2.9 All detectors shall be supplied with all necessary tools to installation, configuration and calibration.
- 14.2.10 All detectors shall inform the maximum power consumption in the worst condition (typically actuated with the heating resistance on).
- 14.2.11 Performance certificates and Classification Societies' approval for each detector model shall be presented for PETROBRAS appraisal.
- 14.2.12 All flame detectors shall be from the same manufacturer.
- 14.2.13 Contractor and Flame detector manufacturer shall issue during Detailed Engineering Design phase the Parameters List for each type of detector including the setting of all parameters to guarantee the detector performance (detection / diagnostic) and comply with the requirements described on Safety studies and others design documents.

15 FLAME ARRESTERS

15.1 General Requirements

- 15.1.1 Design shall be in accordance with the following standards:
- ASTM F 1273 – STANDARD SPECIFICATION FOR TANK VENT FLAME ARRESTER;
 - ISO-16852 – FLAME ARRESTERS - PERFORMANCE REQUIREMENTS, TEST METHODS AND LIMITS FOR USE.
- 15.1.2 Dimensioning conditions and type shall be clearly indicated at the data sheets. Flame arresters shall be suitable for service with IIA gas group.
- 15.1.3 Material of construction for the entire arrester shall be AISI 316 stainless steel as a minimum, or more noble materials compatible with piping spec.
- 15.1.4 The construction shall assure easy access to the arrester bank for inspecting its internals as well as its replacement. Flame arresters shall operate in vertical position.
- 15.1.5 Flame Arrester shall be detonation type supplied with Type K thermocouple. In case of flame detection, flame arrester system shall automatically trip, and signal alarm at CCR.

	TECHNICAL SPECIFICATION	Nº I-ET-3010.2D-1200-800-P4X-005	REV. C
	AREA:	ATAPU 2 AND SÉPIA 2	SHEET 42 of 48
	TITLE:	FIELD INSTRUMENTATION	INTERNAL
			ESUP

16 FUSIBLE PLUG

16.1 General Requirements

16.1.1 Refer to I-ET-3010.00-1200-800-P4X-013 - GENERAL CRITERIA FOR INSTRUMENTATION PROJECTS and I-ET-3010.00-1200-800-P4X-015 - REQUIREMENTS FOR TUBING AND FITTING (ALIGNED TO IOGP-JIP33 S-716) for constructive characteristics, features and performance requirements of Fusible Plugs and Fusible Plugs' Networks.

16.1.2 Active and passive resources for protection against fire shall comply with the requirements defined in DR-ENGP-M-I-1.3 – SAFETY ENGINEERING, including fusible plug detectors quantity and location requirements.

16.1.3 Refer to item 11.4 for ADV features and performance requirements.

16.1.4 The following instrument/equipment shall make part of each fusible plug network:

- Air supply tubing;
- Air reservoir to guarantee air supply for at least 2 (two) acting cycles of the ADV in case of air supply failure;
- Pressure gauge to monitor air supply line, suitable for pressure detection from 0 – 1200 kPa;
- Pressure reducing valve (regulator) to provide 500 kPa (fusible plug network) air pressure to the ADV actuators as indicated in the operational conditions of the ADV data sheets;
- Restriction orifice (FO) with 0.4mm diameter to guarantee the recovery of air pressure in case of spurious leakages in the network;
- By-pass valve, spring push-button type. Needle valve shall not be used for this service;
- For modules with fire detection made by fusible plugs and flame detectors, in the lower elevations, 2 (two) pressure transmitters with local indication in a 1oo2 voting scheme to monitor the inlet pressure of the ADV actuators and interlocking in case of low pressure shall be used, with a virtual switch set at 450 kPa (signal to FGS/HFGS Logic in order to open the ADV, to carry out actions according to I-FD-3010.2D-5400-947-P4X-001 – SAFETY DATA SHEET – TOPSIDE and I-FD-3010.2E-5400-947-P4X-001 - SAFETY DATA SHEET - HULL). In the upper elevations, 3 (three) PITs in a 2oo3 voting scheme shall be used, commanding the ADV directly (without flame detectors voting).

NOTE: areas protected only by fusible plugs network, 3 (three) PITs in a 2oo3 voting scheme shall be considered.

- Pressure gauges to monitor the inlet pressure of the piloted valve, suitable for pressure detection from 0 – 600 kPa;
- Pressure gauges to monitor the inlet pressure of the ADV actuator, suitable for pressure detection from 0 – 600 kPa;
- Piloted valves directly actuated by the fusible plug network with manual reset;

	TECHNICAL SPECIFICATION	Nº	I-ET-3010.2D-1200-800-P4X-005	REV.	C	
	AREA:	ATAPU 2 AND SÉPIA 2			SHEET	43 of 48
	TITLE:	FIELD INSTRUMENTATION			INTERNAL	
					ESUP	

- Manual three-way ball valves for the manual depressurization of the ADV actuator;
- Ball valve with plug;
- ADV (See item 11.4);
- For further details and quantities of the items mentioned above, see instrumentation diagram in the I-DE-3010.2D-1200-944-P4X-001 – GENERAL NOTES.

16.1.5 Certifying requirements for the fire-fighting equipment and materials shall comply with the Classification Society requirements.

16.1.6 Tubing to be used in the fusible plug networks shall be seamless with at 3/8" OD diameter and the connections fittings shall necessarily use the technology of double ferrules 3/8" OD.

17 INSTALLATION MATERIALS

17.1 Junction Boxes (JB)

17.1.1 JB tags shall be according to I-ET-3000.00-1200-940-P4X-001 – TAGGING PROCEDURE FOR PRODUCTION UNITS DESIGN.

17.1.2 Refer to I-ET-3010.00-1200-800-P4X-013 - GENERAL CRITERIA FOR INSTRUMENTATION PROJECTS for JB features and requirements.

17.1.3 JBs shall be ample sized, with minimum of 20% spare (Terminals, cable entries).

17.1.4 Mounting brackets, bolts and nuts shall also be of stainless steel material (AISI 316L). Supports shall be in carbon steel and painted according to I-ET-3010.00-1200-956-P4X-002 - GENERAL PAINTING.

17.1.5 All terminals shall be with non-sparking terminations, capable of withstanding vibration and environmental conditions. Number of terminals per instrument junction box shall be standardized. All terminals shall be standardized among the UNIT.

17.1.6 Signals to CSS related to PSD/HSD and FGS/HFGS sub-systems shall be segregated in different terminal strips and multicables (where applicable), when installed inside the same junction box.

17.1.7 Where required, the JBs shall have 1 (one) ground bar for grounding the armoring of cables. This bar shall be internally wired to the ground terminal of the box and it shall be provided with sufficient screws for terminating armor grounding wires. Each gland or gland plate shall be electrically bonded to its relevant equipment ground bar or terminal /junction box grounding stud. For further details on grounding of instrumentation circuits, refer to I-ET-3010.00-1200-800-P4X-013 - GENERAL CRITERIA FOR INSTRUMENTATION PROJECTS.

	TECHNICAL SPECIFICATION	Nº I-ET-3010.2D-1200-800-P4X-005	REV. C
	AREA:	ATAPU 2 AND SÉPIA 2	SHEET 44 of 48
	TITLE:	FIELD INSTRUMENTATION	INTERNAL
			ESUP

- 17.1.8 For discrete instrument's cables, shield drain wires from instruments shall be interconnected in the junction box and shall only be grounded on a dedicated ground bar for shield drain wires in the control panel.
- 17.1.9 For Analogic instrument's cable shield drain wires shall be connected to its respective multicable pair/triad/quad individual shield drain wire and then connected to a dedicated grounding bar shield drain wires on the control panel. Shield drain shall be electrically continuous from the instruments until the control panel.
- 17.1.10 The overall shield drain wire on multicables shall be connected to a dedicated grounding bar shield drain in the control panel and shall be left unconnected at junction box according to IEC-60079-14.
- 17.1.11 Each outdoor junction box shall have a ground bolt at the outside for bonding to the skid structure. This bolt shall terminate at the inside to provide a grounding means inside the junction box to the safety ground bar.
- 17.1.12 Instruments installed within the module that should be connected to its respective control panel at AEPR (M-17) or CCR-EA (Hull) shall have their cables routed through a junction box at the battery limit of the Module or Hull area. Routing and connections internal to module shall comply with this specification and I-ET-3010.00-1200-800-P4X-013 - GENERAL CRITERIA FOR INSTRUMENTATION PROJECTS.
- 17.1.13 Instrumentation cables conveying actuation and position feedback signals to/from ADVs and BDVs, as well as signals from fire and gas detectors throughout the UNIT, shall be routed to CSS-FGS at AEPR (Module M-17) or to CSS-HFGS at CCR-EA through JBs to be located at the battery limits of the Modules. The criteria for quantifying and locating these junction boxes shall maximize availability of loops; at least one JB per Module level shall be foreseen.
- NOTE:** Since those JBs are part of Safety System (FGS/HFGS), proper location and integrity protection shall be applied in order to withstand fire conditions.

17.2 Cable Glands

- 17.2.1 For instruments: As per I-ET-3010.00-1200-800-P4X-013 – GENERAL CRITERIA FOR INSTRUMENTATION PROJECTS, electric connections shall be ½" NPT (F).
- 17.2.2 For Instrumentation Junction Boxes:
- Cable glands for steel sheet enclosures shall have cylindrical thread with locknut.
 - For all other cases, the threaded joints shall be taper type, NPT with standardized tolerances, according to ASME B 1.20.1.

	TECHNICAL SPECIFICATION	Nº I-ET-3010.2D-1200-800-P4X-005	REV. C
	AREA:	ATAPU 2 AND SÉPIA 2	SHEET 45 of 48
	TITLE:	FIELD INSTRUMENTATION	INTERNAL
			ESUP

17.2.3 Cable glands connected to equipment installed in hazardous areas or with any type of Ex classification shall comply with IEC-60079-14, especially item 10 - Cable entry systems and blanking elements and its subitems; threads shall comply with IEC-60079-0.

17.2.4 Cable glands sealed with setting compound is not acceptable.

17.3 Cable Trays and Cables

17.3.1 Refer to I-ET-3010.00-1200-800-P4X-013 - GENERAL CRITERIA FOR INSTRUMENTATION PROJECTS for Cable Trays features and requirements.

17.3.2 Cables/cable trays up to battery limit Junction Box shall be supplied mounted and tested. A calculation memory of the cable trays' occupation, consistent with 3D model and cable tray list, shall be supplied, respecting the occupation requirement defined in I-ET-3010.00-1200-800-P4X-013 – GENERAL CRITERIA FOR INSTRUMENTATION PROJECTS.

17.3.3 All cables shall be clearly identified for both outdoor and indoor installations.

17.3.3.1 For cables in outdoor installation:

- The nameplate shall be made of stainless steel;
- The nameplate shall be fixed with stainless steel or rubber clamps on the outer sheath and in both ends;
- The nameplate size shall be suitable to the cable diameter;
- The wires inside panels or junction boxes shall be identified with plastic or rubberized labels.

17.3.3.2 For cables in indoor installation:

- The nameplate shall be made of plastic or rubber;
- The nameplate shall be fixed with plastic or rubber clamps on the outer sheaths and in both ends;
- The nameplate size shall be suitable to the cable diameter;
- The wires inside panels or junction boxes shall be identified with plastic or rubberized labels.

17.3.4 For criteria related to modeling, sizing and documentation relative to cable trays, except occupation criteria, refer to I-ET-3010.00-5140-700-P4X-001 – SPECIFICATION FOR ELECTRICAL DESIGN FOR OFFSHORE UNITS and I-ET-3010.00-1200-800-P4X-013 - GENERAL CRITERIA FOR INSTRUMENTATION PROJECTS.

17.4 Pushbuttons

17.4.1 Electrical loads pushbuttons shall be in accordance with I-ET-3010.00-5140-700-P4X-002 - SPECIFICATION FOR ELECTRICAL MATERIAL FOR OFFSHORE UNITS.

	TECHNICAL SPECIFICATION	Nº	I-ET-3010.2D-1200-800-P4X-005	REV.	C	
	AREA:	ATAPU 2 AND SÉPIA 2			SHEET	46 of 48
	TITLE:	FIELD INSTRUMENTATION			INTERNAL	
					ESUP	

17.5 Miscellaneous

17.5.1 All electrical/electronic components subjected to direct sun incidence shall have a cover, in order to minimize damage caused to excessive heating of the component's enclosure.

18 INSTRUMENT ASSEMBLY MATERIAL

18.1 Material Selection Requirements

18.1.1 All instruments and installation material shall be mounted and installed according to PETROBRAS standards and piping specifications I-ET-3010.2D-1200-200-P4X-001 – PIPING SPECIFICATION FOR TOPSIDES, I-ET-3010.2E-1200-200-P4X-001 – PIPING SPECIFICATION FOR HULL and typical hook-up drawings.

18.1.2 All material shall have high quality regarding dielectric rigidity, mechanical, thermal and chemical resistance, following in a strictly manner the standards used for its fabrication.

18.1.3 All material employed shall be non-hygroscopic, flame retardant and resistant to corrosion caused by a saline atmosphere environment with the presence of moisture and contact with hydrocarbons.

18.1.4 All screws, nuts and washers shall be made of bichromatized steel or AISI-316 stainless steel.

18.1.5 In order to avoid electrolytic corrosion, contacts between different metallic materials shall be prevented. Galvanic isolation shall be implemented where contact between different metallic materials is necessary.

18.1.6 Manufacturers shall keep uniformity of components for the same supply. The same model for plugs, junction boxes and all bulk material shall be used in all UNIT modules.

18.1.7 For parts of the assembly not specifically detailed by PETROBRAS, the following requirements shall be taken into account:

- Galvanized bolts and nuts shall not be used.
- Ductile iron shall not be used without the prior formal approval of PETROBRAS.
- All proposed plastic components shall be as a minimum flame retardant UV resistant, and non-degradable.
- All spindles, bushings, bolting, screws, etc. shall be manufactured from a suitable grade of stainless steel or other corrosion proof material.
- All molded polyester parts shall be in an anti-static version for hazardous area locations.
- The use of asbestos in any form is prohibited.
- The use of aluminum and cast iron is prohibited.

- Whenever there is a need to use different materials in contact, one with another one, which may favor galvanic corrosion, protection procedures shall be foreseen, such as insulation, besides the use of anti-oxidant products.

18.1.8 It is not allowed to install cables, cable trays, conduits, tubing or piping at void spaces.

18.2 Electrical Hook-up

18.2.1 For electrical hook-up, special attention shall be given to electrical connections inside electrical terminal compartment of the instruments in order to connect the signal cables properly, do the right insulation for shield drain wire and also to protect the cables against any risks of short circuit (see Figure 3). For more details see I-ET-3010.00-1200-800-P4X-013 - GENERAL CRITERIA FOR INSTRUMENTATION PROJECTS.

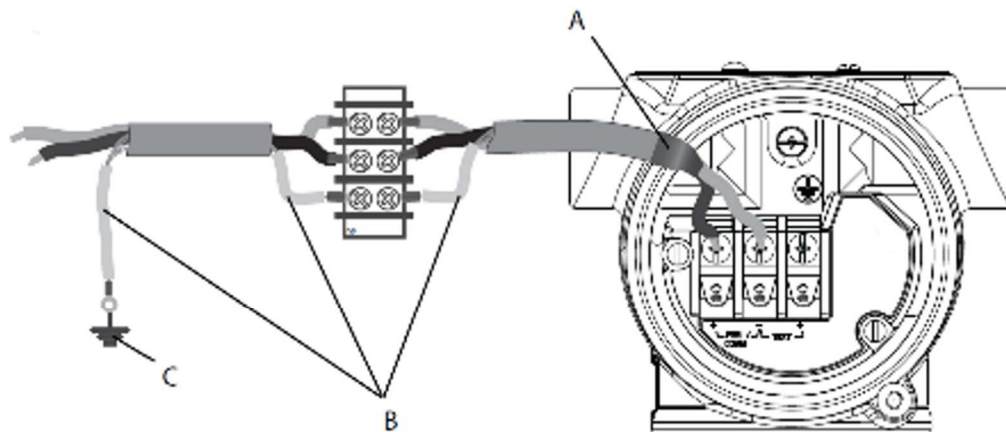

A - Insulate shield drain wire and cables and proper cables protection

B - Insulate exposed shield drain wire

C - Terminate cable shield drain wire to earth ground

Figure 3 - Electrical Hook-up – Instruments

18.3 Heat Tracing

18.3.1 Heat tracing system shall be of electric type.

18.3.2 Thermostats to limit the temperature shall be included in the design.

18.3.3 Heat tracing devices shall be properly assembled, by certified personnel, following the manufacturer instructions and drawings, in order to distribute the heat homogenously through the whole process connection, standpipe (when applicable) and the instrument.

	TECHNICAL SPECIFICATION	Nº I-ET-3010.2D-1200-800-P4X-005	REV. C
	AREA:	ATAPU 2 AND SÉPIA 2	SHEET 48 of 48
	TITLE:	FIELD INSTRUMENTATION	INTERNAL
			ESUP

18.3.4 Heat tracing system design shall comprise:

- Calculation of heat loss, heater power output, developed power ratio, required heater length, determination of heater pitch according to pipe size.
- Self-regulating heat output in response to changes in temperature.
- Use of heating metallic over shielded cables approved for use in hazardous areas;
- Use of ground fault protective devices.