	TECHNICAL SPECIFICATION	No. I-ET-3010.00-5262-700-P4X-001
	CLIENT:	SHEET: 1 of 54
	JOB:	
	AREA:	
SRGE	TITLE: AUXILIARY GENERATOR PACKAGE FOR OFFSHORE UNITS	INTERNAL
		ESUP

MICROSOFT WORD / V. 365 / I-ET-3010.00-5262-700-P4X-001_H.DOCX

INDEX OF REVISIONS

REV.	DESCRIPTION AND/OR REVISED SHEETS
0	ORIGINAL ISSUE
A	REVISED WHERE INDICATED
B	REVISED WHERE INDICATED
C	REVISED WHERE INDICATED
D	REVISED WHERE INDICATED DUE TO CONSISTENCY ANALYSIS
E	REVISED WHERE INDICATED
F	REVISED WHERE INDICATED
G	REVISED WHERE INDICATED
H	REVISED WHERE INDICATED

	REV. 0	REV. A	REV. B	REV. C	REV. D	REV. E	REV. F	REV. G	REV. H
DATE	OCT/02/18	NOV/28/19	MAR/30/20	JUN/24/20	JUL/22/20	FEB/23/21	NOV/12/21	SEP/30/22	DEC/13/22
DESIGN	ESUP	ESUP	ESUP	ESUP	ESUP	EEI/ESES	EEI/ESES	EEI/ESES	EEI/ESES
EXECUTION	HEITORFAVO	MARCELO BP	THIAGOVINHA	THIAGOVINHA	THAYSE	KJK9	BD36	U4QR	UR7U
CHECK	PFERRAZ	FLAVIUS	CARLA	MARCELO BP	BAYO	BD36	KJK9	CTLX	CTLX
APPROVAL	BAYO	REGGIANI	REGGIANI	REGGIANI	REGGIANI	UQBE	UQBK	UQBE	UQBE

THE INFORMATION CONTAINED IN THIS DOCUMENT IS PETROBRAS PROPERTY AND MAY NOT BE USED FOR PURPOSES OTHER THAN THOSE SPECIFICALLY INDICATED HEREIN.

THIS FORM IS PART OF PETROBRAS N-381 REV. K.



AREA:

SHEET: 2 of 54

TITLE:

**AUXILIARY GENERATOR PACKAGE FOR OFFSHORE
UNITS**

INTERNAL

ESUP

TABLE OF CONTENTS

1.	OBJECTIVE.....	4
2.	DEFINITIONS.....	4
3.	REFERENCE STANDARDS AND DOCUMENTS.....	4
3.1.	STANDARDS AND RULES.....	4
3.2.	REFERENCE DOCUMENTS.....	6
4.	GENERAL CONDITIONS.....	7
4.1.	GENERAL.....	7
4.2.	ENVIRONMENTAL CONDITIONS.....	8
4.3.	INCLINATION REQUIREMENTS.....	8
4.4.	SITE VIBRATIONS AND ACCELERATIONS.....	8
5.	GENERATOR GROUP.....	9
5.1.	GENERAL.....	9
5.2.	SCOPE OF SUPPLY.....	9
5.3.	PAINTING.....	10
5.4.	NOISE CONTROL REQUIREMENTS.....	11
6.	DIESEL ENGINE.....	12
6.1.	GENERAL.....	12
6.2.	EXHAUST SYSTEM.....	13
6.3.	STARTING SYSTEM.....	13
6.4.	COMBUSTION AIR SYSTEM.....	15
6.5.	COOLING SYSTEM.....	15
6.6.	DIESEL OIL SYSTEM.....	16
6.7.	LUBRICATION SYSTEM.....	17
6.8.	COUPLING AND TURNING DEVICE.....	18
6.9.	VIBRATION LIMITS AND ISOLATION.....	18
6.10.	SUPPORT SKID.....	18
7.	ELECTRICAL GENERATOR.....	19
7.1.	GENERAL.....	19
7.2.	EXCITATION.....	20
7.3.	INSULATION.....	21
7.4.	BEARINGS.....	21
7.5.	COOLING SYSTEM.....	21
7.6.	TERMINALS.....	22
7.7.	TERMINAL BOXES.....	22
7.8.	TEMPERATURE DETECTORS.....	23
7.9.	SPACE HEATERS.....	23
7.10.	WIRING.....	24
7.11.	GROUNDING SYSTEM.....	24
7.12.	NAMEPLATES.....	24
8.	CHARACTERISTICS OF ELECTRICAL PANELS AND EQUIPMENT.....	25
8.1.	GENERAL CHARACTERISTICS.....	25
8.2.	AUXILIARY SWITCHGEAR.....	26
8.3.	AUXILIARY GENERATOR POWER AND CONTROL PANEL (AGCP) (PN-UG-5262501-01).....	26
8.4.	AUTOMATIC VOLTAGE REGULATOR (AVR).....	27
8.5.	AUXILIARY GENERATOR CONTROLLER (AGC).....	28
8.6.	AUXILIARY GENERATOR ENGINE LOCAL CONTROL PANEL (PN-UG-5262501-02).....	31
8.7.	STARTING AND INTERLOCKING.....	31
8.8.	BATTERY AND BATTERY-CHARGERS.....	32
9.	PROTECTION.....	32
9.1.	PROTECTIVE RELAYS.....	32
9.2.	PROTECTION.....	33
9.3.	CURRENT TRANSFORMERS (CTs) AND VOLTAGE TRANSFORMERS (VTs).....	34
10.	SYNCHRONIZATION CRITERIA.....	34
10.1.	GENERAL REQUIREMENTS.....	34
11.	INSPECTION AND TESTING.....	36
11.1.	GENERAL REQUIREMENTS.....	36
11.2.	LIST OF MINIMUM TESTS.....	37
12.	TECHNICAL DOCUMENTATION.....	42
13.	ADDITIONAL REQUIREMENTS FOR GENERIC GENERATOR PACKAGES.....	46
13.1.	APPLICATION.....	46
13.2.	ADDITIONAL SCOPE OF SUPPLY.....	47
13.3.	GENERAL.....	47



TECHNICAL SPECIFICATION

No. I-ET-3010.00-5262-700-P4X-001

REV. H

AREA:

SHEET: 3 of 54

TITLE: **AUXILIARY GENERATOR PACKAGE FOR OFFSHORE UNITS**

INTERNAL

ESUP

13.4. MECHANICAL AND PIPING..... 47
13.5. PACKAGE LOCATION AND AREA CLASSIFICATION..... 49
13.6. HVAC SYSTEM 49
13.7. SAFETY REQUIREMENTS..... 50
13.8. MATERIALS 50
13.9. ENCLOSURE..... 51
13.10. AUTOMATION, CONTROL AND INSTRUMENTATION SYSTEM..... 51
13.11. ENCLOSURE ELECTRICAL INSTALLATIONS 51
13.12. PERSONNEL PROTECTION AND THERMAL INSULATION 51
14. ABBREVIATIONS AND ACRONYMS 51
15. HOLD POINTS 52
16. ANNEX I – SUBMISSION NOISE DATA FORMS..... 53



1. OBJECTIVE

This Specification establishes the minimum requirements for design, manufacture and supply of the Auxiliary Generator Package for PETROBRAS Offshore Units.

Additional requirements for Auxiliaries Generators not directly connected to Essential or Auxiliary Switchgears, installed in container are provided in item 13. ADDITIONAL REQUIREMENTS FOR GENERIC GENERATOR.

2. DEFINITIONS

For information about general terminology meaning, see [18] .

3. REFERENCE STANDARDS AND DOCUMENTS

3.1. STANDARDS AND RULES

3.1.1. The Auxiliary Generator Package and its installations shall comply with all rules and regulations stated by Brazilian Authorities, Classification Society and International Standards, all in their last revisions. Following these mandatory requirements, the Auxiliary Generator Package shall comply with requirements of documents listed in 3.2 (second priority in case of conflict).

3.1.2. At the design development and for equipment specification International Standards (IEC) shall be used. When required and exceptionally, when it is clearly justified, ANSI, NEMA, IEEE and others foreign recognized standards may be used. Their use shall be restricted to specific cases and shall be previously approved by PETROBRAS.

3.1.3. IEC - INTERNATIONAL ELECTROTECHNICAL COMMISSION

IEC 60034	Rotating Electrical Machine - All Parts;
IEC 60092-301	Electrical Installations in Ships - Part: 301 - Equipment - Generators and Motors (where applicable);
IEC 60092-502	Electrical Installations in Ships - Part: 502 - Tankers - Special Features (where applicable);
IEC 60533	Electrical and Electronic Installations in Ships - Electromagnetic Compatibility (EMC) – Ships with a Metallic Hull;
IEC 61000-4-7	Electromagnetic Compatibility (EMC) – Part 4-7: Testing and Measurement Techniques – General Guide on Harmonics and Interharmonics Measurement and Instrumentation, for Power Supply Systems and Equipment Connected Thereto;
IEC 61260	Electroacoustic - Octave-band and Fractional-octave-band Filters – all parts;
IEC 61439	Low-Voltage Switchgear and Controlgear Assemblies – All Parts;
IEC 61672-1	Electroacoustics - Sound Level Meters - Part 1: Specifications;
IEC 61672-2	Electroacoustics - Sound Level Meters - Part 1: Pattern Evaluation Tests;

**TECHNICAL SPECIFICATION**

No. I-ET-3010.00-5262-700-P4X-001

REV. H

AREA:

SHEET: 5 of 54

TITLE:

**AUXILIARY GENERATOR PACKAGE FOR OFFSHORE
UNITS**

INTERNAL

ESUP

IEC 61850 Communication Networks and Systems for Power Utility Automation - All Parts;

IEC 61892 Mobile and Fixed Offshore Units - Electrical Installations - All Parts.

3.1.4. IEEE - INSTITUTE OF ELECTRICAL AND ELECTRONIC ENGINEERING

IEEE Std 43 Recommended Practice for Testing Insulation Resistance of Rotating Machinery;

IEEE 115 Guide for Test Procedures for Synchronous Machines – Part I / Part II;

3.1.5. IMO - INTERNATIONAL MARITIME ORGANIZATION

IMO EA811E Code for the Construction and Equipment of Mobile Offshore Drilling Units (MODU CODE);

IMO IB664E Marpol Annex VI - Regulation for the Prevention of Air Pollution from Ships and NOx Technical Code;

3.1.6. ISO - INTERNATIONAL ORGANIZATION FOR STANDARDIZATION

ISO 3046 Reciprocating Internal Combustion Engines;

ISO 8528 Reciprocating Internal Combustion Engine Driven Alternating Current Generating Sets.

3.1.7. ASME - AMERICAN SOCIETY OF MECHANICAL ENGINEERS

ASME B16.5 Pipe Flanges and Flanged Fittings NPS 1/2 Through NPS 24 Metric/Inch Standard;

ASME B31.3 Process Piping;

ASME PTC 17 Reciprocating Internal-Combustion Engines.

3.1.8. BRAZILIAN LABOUR AND EMPLOYMENT MINISTRY

NR-10 Segurança em Instalações e Serviços em Eletricidade;

NR-12 Segurança no Trabalho em Máquinas e Equipamentos;

NR-13 Caldeiras, Vasos de Pressão e Tubulações em Tanques Metálicos de Armazenamento (where applicable);

NR-17 Ergonomia;

NR-26 Sinalização de Segurança;

NR-30 Segurança e Saúde no Trabalho Aquaviário - Anexo II - Plataformas e Instalações de Apoio;

NR-37 Segurança e Saúde em Plataformas de Petróleo.

3.1.9. API - AMERICAN PETROLEUM INSTITUTE

API 7B-11C Specification for Internal-Combustion Reciprocating Engines for Oil-Field Service;

**TECHNICAL SPECIFICATION**

No. I-ET-3010.00-5262-700-P4X-001

REV. H

AREA:

SHEET: 6 of 54

TITLE:

**AUXILIARY GENERATOR PACKAGE FOR OFFSHORE
UNITS**

INTERNAL

ESUP

API 546 Brushless Synchronous Machines - 500 kVA and Larger.

API RP 686 Recommended Practice for Machinery Installation and Installation Design

3.1.10. NFPA - NATIONAL FIRE PROTECTION ASSOCIATION

NFPA 110 Standard for Emergency and Standby Power Systems.

3.1.11. AWS - AMERICAN WELDING SOCIETY

AWS D1.1 Structural Welding Code - Steel.

3.1.12. CLASSIFICATION SOCIETY

CS Rules and Regulations of the Classification Society.

3.1.1 CLASSIFICATION SOCIETY

AP 42 Compilation of Air Pollutant Emission Factors, Volume 1: Stationary Point and Area Sources.

3.2. REFERENCE DOCUMENTS

- [1] PROJECT ONE-LINE DIAGRAM
- [2] I-DE-3010.00-5140-797-P4X-001 - ELECTRICAL SYSTEM AUTOMATION ARCHITECTURE DIAGRAM
- [3] I-ET-3010.00-5140-797-P4X-001 - ELECTRICAL SYSTEM AUTOMATION ARCHITECTURE
- [4] I-ET-3010.00-5140-700-P4X-001 - SPECIFICATION FOR ELECTRICAL DESIGN FOR OFFSHORE UNITS
- [5] I-ET-3010.00-5140-700-P4X-002 - SPECIFICATION FOR ELECTRICAL MATERIAL FOR OFFSHORE UNITS
- [6] I-ET-3010.00-5140-700-P4X-003 - ELECTRICAL REQUIREMENTS FOR PACKAGES FOR OFFSHORE UNITS
- [7] I-ET-3010.00-5140-700-P4X-005 - REQUIREMENTS FOR HUMAN ENGINEERING DESIGN FOR ELECTRICAL SYSTEMS OF OFFSHORE UNITS
- [8] I-ET-3010.00-5140-741-P4X-004 - SPECIFICATION FOR LOW-VOLTAGE GENERIC ELECTRICAL PANELS FOR OFFSHORE UNITS
- [9] I-ET-3010.00-5140-714-P4X-001 - SPECIFICATION FOR ELECTRICAL BATTERIES FOR OFFSHORE UNITS
- [10] I-ET-3010.00-5140-773-P4X-002 - SPECIFICATION FOR GENERIC D.C. UPS FOR OFFSHORE UNITS
- [11] I-ET-3010.00-1200-956-P4X-002 - GENERAL PAINTING
- [12] I-ET-3010.00-5143-700-P4X-001 - ELECTRICAL SYSTEM PROTECTION CRITERIA

	TECHNICAL SPECIFICATION	No. I-ET-3010.00-5262-700-P4X-001	REV. H
	AREA:	SHEET: 7 of 54	
	TITLE: AUXILIARY GENERATOR PACKAGE FOR OFFSHORE UNITS	INTERNAL	
			ESUP
[13]	I-LI-3010.00-5140-700-P4X-001 - ELECTRICAL EQUIPMENT DATA-SHEET MODELS		
[14]	I-LI-3010.00-5140-797-P4X-001 - ELECTRICAL SYSTEM AUTOMATION INTERFACE SIGNALS LIST		
[15]	I-ET-3010.00-1200-300-P4X-001 - NOISE AND VIBRATION CONTROL REQUIREMENTS		
[16]	DR-ENGP-M-I-1.3 - SAFETY ENGINEERING		
[17]	I-DE-3010.00-5140-700-P4X-003 - GROUNDING INSTALLATION TYPICAL DETAILS		
[18]	I-ET-3010.00-1200-940-P4X-002 - GENERAL TECHNICAL TERMS		
[19]	HVAC PROJECT DOCUMENTATION		
[20]	I-DE-3010.00-1400-140-P4X-004 - GENERAL NOTES FOR TOPSIDES STRUCTURES		
[21]	PROJECT STRUCTURAL REQUIREMENTS SPECIFICATION		
[22]	I-ET-3010.00-1200-251-P4X-001 - REQUIREMENTS FOR BOLTING MATERIALS		
[23]	I-ET-3010.00-1200-540-P4X-001 - REQUIREMENTS FOR PRESSURE VESSELS DESIGN		
[24]	I-ET-3010.00-1200-955-P4X-001 - WELDING		
[25]	CANCELLED		
[26]	PROJECT MOTION ANALYSIS REPORT		
[27]	PROJECT MODULE LAYOUT PLAN		
[28]	PROJECT AREA CLASSIFICATION		
[29]	AUTOMATION INTERFACE OF PACKAGE UNITS SPECIFICATION		
[30]	I-ET-3010.00-1200-800-P4X-002 - AUTOMATION, CONTROL AND INSTRUMENTATION ON PACKAGE UNITS		
[31]	I-ET-3010.00-1200-800-P4X-013 - GENERAL CRITERIA FOR INSTRUMENTATION PROJECTS		
[32]	I-ET-3010.00-1200-431-P4X-001 - THERMAL INSULATION FOR MARITIME INSTALLATIONS		
	<p>Note: Documents without code in the list are documents with variations according to project characteristics. Verify in project documentation list the reference for codes of these documents.</p>		
	<h4>4. GENERAL CONDITIONS</h4>		
	<h5>4.1. GENERAL</h5>		
	<p>4.1.1. Unless otherwise specified in the project documentation, the generator and its auxiliary system shall be designed and manufactured taking into account a minimum life period of 30 years.</p>		



AREA:

SHEET: 8 of 54

TITLE:

**AUXILIARY GENERATOR PACKAGE FOR OFFSHORE
UNITS**

INTERNAL

ESUP

- 4.1.2. The supplier of the generator group (hereafter stated as PACKAGER) shall fill in the Data Sheet, for proposal, the hatched items and the items corresponding to the list of standards applicable to design, manufacture and testing of equipment and accessories. The other items shall be filled in after eventual purchase order.
- 4.1.3. All the requirements for the Auxiliary Generator Package shall be according to items below.
- 4.1.4. Auxiliary Generator Group shall be sized according to Project Documentation.
- 4.1.5. All equipment, materials, accessories and installations within the Auxiliary Generator Package shall be certified by Classification Society.
- 4.1.6. Electrical equipment installed in external areas, that shall be kept operating during emergency shutdown ESD-3P or ESD-3T shall be certified with the type of protection and EPL Gc, suitable for installation in hazardous areas Zone 2 Group IIA temperature T3, unless they are automatically de-energized in case of confirmed gas in equipment area, according to IEC 61892-1.
- 4.1.7. Electrical equipment internal to Package shall be sized according to requirements of I-ET-3010.00-5140-700-P4X-001 - SPECIFICATION FOR ELECTRICAL DESIGN FOR OFFSHORE UNITS.
- 4.1.8. Electrical installations inside the Package shall comply with requirements of I-ET-3010.00-5140-700-P4X-001 - SPECIFICATION FOR ELECTRICAL DESIGN FOR OFFSHORE UNITS.
- 4.1.9. PACKAGER shall provide all equipment in Auxiliary Generator room prepared to Water Mist fire-fighting method and IP-54 (minimum) when defined water mist method in project documentation.
- 4.1.10. It shall not be acceptable out of date or obsolete equipment or components. Technical support and supply of replacement parts shall be guaranteed for ten (10) years.
- 4.1.11. PETROBRAS shall have full access to the whole documentation and data related to the Package, including (but not limited to) diagrams, source codes of software, licenses, passwords, configurations, parameterizations, controls, alarms, events registers, etc.

4.2. ENVIRONMENTAL CONDITIONS

- 4.2.1. It shall be considered design ambient temperature 45°C. All components of the Generator Package shall be suitable to be installed in a marine environment. For details about location, see Project Documentation.

4.3. INCLINATION REQUIREMENTS

- 4.3.1. The entire generator group, including accessories, shall be suitable to operate under inclination variations (static and dynamic) specified by IMO EA811E (MODU CODE) and Classification Society.

4.4. SITE VIBRATIONS AND ACCELERATIONS

- 4.4.1. Machine and its auxiliaries shall be constructed to withstand vibration and shock likely to arise under normal service, without malfunctioning, or electrical connections loosening, complying with the requirements of Classification Society rules and IEC 61892-1.

- 4.4.2. Enclosing cases for electrical equipment shall not be affected by distortion, vibrations and movements of the unit construction, or by risk of damage, complying with the requirements of IEC 61892-1.

5. GENERATOR GROUP

5.1. GENERAL

- 5.1.1. The PACKAGER shall be responsible to the lay-out of the equipment, accessories and piping around the skid, taking into account the space required for operation, maintenance and considering that the spaces and weights shall be the least possible.
- 5.1.2. The Generator Group shall be capable to operate depending only on its fuel system and its start-up system. No other external equipment or system shall be necessary for proper operation of the Generator Group.
- 5.1.3. The generator group shall withstand for 1 hour a current value equivalent to at least 110% of the rated value, according to Classification Society Rules (not applicable to Generic Generators).

5.2. SCOPE OF SUPPLY

- 5.2.1. At least the following systems and items shall be provided by PACKAGER:
- a) Complete engine with all necessary auxiliary equipment and devices;
 - b) Complete AC generator with excitation system and all necessary auxiliary equipment and devices;
 - c) Complete skid assembly with resilient mounting for engine, generator and auxiliaries installed on a common bed plate;
 - d) Flexible coupling between engine and generator;
 - e) Vibration isolation with elastic suspension;
 - f) Engine local panel for control, protection and metering;
 - g) Software license, for controllers and electronic devices;
 - h) Generator local power and control panel for control, protection, metering, synchronization, power distribution and auxiliary equipment control (AGCP);
 - i) Engine speed governor;
 - j) Generator Automatic Voltage Regulator (AVR);
 - k) Exhaust system with silencer, expansion joints, transition piece and spark arrester, built of AISI 316L;
 - l) Complete dual engine starting system;
 - m) Complete combustion air system, including air intake filter and accessories;
 - n) Complete air cooling system for engine, including skid mounted radiator and shaft mounted fan;
 - o) All piping, fuel oil system, combustion air and exhaust gas with the diesel up to the edge of the skid;

**TECHNICAL SPECIFICATION**

No. I-ET-3010.00-5262-700-P4X-001

REV. H

AREA:

SHEET: 10 of 54

TITLE:

**AUXILIARY GENERATOR PACKAGE FOR OFFSHORE
UNITS**

INTERNAL

ESUP

- p) Complete lubrication system, including main lubrication pump, pre-lubrication pump, pre-lubrication hand pump and fine filter;
- q) Turning device and guard;
- r) Engine pre-heating system by resistors;
- s) Erosion/corrosion protection;
- t) Unusual tools for assembly, disassembly, installation, commissioning, operation and maintenance;
- u) Battery-chargers and associated battery banks;
- v) Spare parts for start-up, commissioning and others as recommended by Classification Society;
- w) Calculation Reports;
- x) Factory and Onboard Acceptance Tests;
- y) Data book with material and tests certificates;
- z) Training;
- aa) Supervision for start-up and commissioning.

5.2.2. The following systems and items shall be supplied by HULL CONTRACTOR:

- a) Start-up air compressor unit, start-up air vessel and air piping;
- b) Complete fuel (diesel oil) system, including fuel daily tank, compensation tank whenever necessary, diesel shut-off valve, pumps and filters;
- c) All necessary interconnecting pipes and valves;
- d) Exhaust duct built of AISI 316L stainless steel;
- e) Protection against penetration of water in the exhaust duct, with valve and drain trap to prevent condensation from returning to the engine;
- f) Exhaust duct isolation according to item 6.2.2;
- g) Generator Room ventilation dampers.

Note: Equipment design shall consider duct pressure loss due to room layout.

5.3. PAINTING

5.3.1. Painting shall be proper for offshore installations, and shall comply with the requirements of I-ET-3010.00-5140-741-P4X-004 - SPECIFICATION FOR LOW-VOLTAGE GENERIC ELECTRICAL PANELS FOR OFFSHORE UNITS

[33] I-ET-3010.00-5140-714-P4X-001 - SPECIFICATION FOR ELECTRICAL BATTERIES FOR OFFSHORE UNITS

[34] I-ET-3010.00-5140-773-P4X-002 – SPECIFICATION FOR GENERIC D.C. UPS FOR OFFSHORE UNITS

5.3.2. I-ET-3010.00-1200-956-P4X-002 - GENERAL PAINTING. The last coat colour shall be Light Green Munsell 5G8/4.



5.4. NOISE CONTROL REQUIREMENTS

- 5.4.1. Noise control analysis is a mandatory item to be carried out. Noise limits shall comply with I-ET-3010.00-1200-300-P4X-001 - NOISE AND VIBRATION CONTROL REQUIREMENTS and with the following requirements, prevailing the most restrictive requirement.
- 5.4.2. The maximum acceptable noise pressure level inside diesel engine rooms is 105dB(A). If more than one diesel engine is installed inside this room, the maximum acceptable level is 108dB(A).
- 5.4.3. The noise limits shall not be exceeded by more than 2dB(A) in any situation.
- 5.4.4. All limits refer to broad band noise without any distinct tonal characteristics. In case of tonal characteristics, the noise level limit shall be set 5dB lower.
- 5.4.5. The Generator Group (engine and generator) shall be installed with resilient mounts, helical springs with the minimum vibration isolation efficiency of 95%. Exhaust duct shall be installed with flexible joints as well as flexible hangers and stabilizers. Engine shall be installed with high performance, reactive, all metallic, double walled silencer for exhaust duct and protected with an acoustic hood, if necessary.
- 5.4.6. HULL CONTRACTOR shall analyse the PACKAGER acoustic data, verifying if all aspects of noise control, such as silencers, hoods, pipeline wrapping and silencers, were incorporated in the Package design and proposal.
- 5.4.7. Maximum noise level of diesel engines shall comply with table below.

Table 1 - Noise Control for Equipment

NOISE CONTROL SYSTEM TO BE USED ⁽¹⁾	MAXIMUM NOISE LEVEL dB(A) @ 1.0m ⁽²⁾	
EXHAUST SILENCER VIBRATION ISOLATION	ENGINE CASING	105
	ENGINE EXHAUST	90
	RADIATOR	83

Notes: 1 - Proposed noise control method;
2 - Maximum acceptable noise level with the proposed noise control method.

- 5.4.8. Discharge of diesel generators engine driven sets should be oriented as far as possible from living quarters or from embarkation station.
- 5.4.9. In case noise limits are higher than allowable, the equipment must be furnished with some noise control reduction measure. PACKAGER may consider the best solution, which may include the supply of an acoustic and thermal hood, with its ventilation system and safety requirements. The use of a different device to comply with noise requirement shall be proved to be efficient and submitted to PETROBRAS approval.
- 5.4.10. PACKAGER shall present noise data regarding the items included in its scope of supply.
- 5.4.11. Noise data are required by PETROBRAS with the Proposal and after the Factory Tests, even if limits of airborne noise emission is not specified by PETROBRAS.
- 5.4.12. All noise data shall be always presented as a continuous equivalent level, Leq, for 60 seconds sampling time, and shall include:
 - Value in dB(A);

- Linear values, not weighted, in the octave bands between 63Hz and 8,000Hz.
- 5.4.13. PACKAGER shall be the sole responsible for the guaranteed airborne sound emission data of the equipment within its scope of supply. These data shall be verified during the Factory Test Phase and a maximum deviation of 2 dB will be allowed, both for the A scale weighted value and for the octave bands between 63Hz and 8,000Hz.
- 5.4.14. For all equipment installed inside acoustic hoods, the following data are required during Proposal Phase:
- Sound power level of the equipment without the acoustic hood;
 - Sound pressure level, in each of the four main directions and in one point of the top, for the equipment plus hood;
 - Acoustical data of the hood and silencers.
- 5.4.15. For all equipment installed without acoustic hood, the following data are required:
- Sound power level of the equipment;
 - Sound pressure level, in each of the four main directions and in one point of the top.
- 5.4.16. If the values measured and reported during the Factory Tests Phase are outside the limits submitted by the PACKAGER with the proposal, and approved by PETROBRAS, the PACKAGER shall provide the means for sound attenuation to the agreed limit. PETROBRAS reserves the right to witness the tests.
- 5.4.17. The procedures for sound measurement assume a condition of free field over reflecting floor. This implies that the tests will be preferably performed in an outside area, with a smooth floor made of concrete, asphalt, etc. If this condition is not satisfied, then the correction for measurements in rooms shall be applied.
- 5.4.18. The sound pressure meter shall be type I, according to IEC 61672-1/2. The characteristics of the octave filter shall be in accordance with IEC 61260.
- 5.4.19. The sound pressure reading shall be made as equivalent continuous level, L_{eq} , for 60s sampling time. The recorded values shall be corrected to the nearest entire value within 1dB.
- 5.4.20. If the difference between the background noise level and the sound level of the equipment plus the background is less than 10dB, the measurements shall be corrected.
- 5.4.21. If the normal operating condition of the machine cannot be reached in the test stand, the PACKAGER shall perform the measurements in the possible conditions, agreeing with PETROBRAS the operational conditions of the test.

6. DIESEL ENGINE

6.1. GENERAL

- 6.1.1. Diesel Engine shall be designed for heavy duty, in continuous operation, with closed fresh water cooling circuit with radiator, four-stroke cycle, direct injection and turbocharger. The engine shall be capable of starting up cold or hot under load, with no dependency on external electric energy supply.

**TECHNICAL SPECIFICATION**

No. I-ET-3010.00-5262-700-P4X-001

REV. H

AREA:

SHEET: 13 of 54

TITLE:

**AUXILIARY GENERATOR PACKAGE FOR OFFSHORE
UNITS**

INTERNAL

ESUP

- 6.1.2. The diesel engine shall comply with IMO I664E MARPOL, annex VI;
- 6.1.3. The engine shall be rated considering "Continuous Power (COP)", as defined in ISO 8528-1.
- 6.1.4. The engine shall be designed, fabricated, installed, tested and operated in accordance with API 7B-11C, ISO 3046, ASME PTC 17 and Classification Society requirements.
- 6.1.5. The speed governor shall be PACKAGER standard.
- 6.1.6. The diesel engine rated speed shall be up to 1800rpm.
- 6.1.7. The diesel engine shall be equipped with shaft-driven alternator for battery-charger.
- 6.1.8. All connections between the engine and the skid (water, lubricating oil, diesel, air, etc.) shall be achieved through flexible metal-lined (such as stainless steel braid) hoses.

6.2. EXHAUST SYSTEM

- 6.2.1. Exhaust system shall be sized to avoid engine performance being jeopardized by backpressure. The exhaust system shall be complete.
- 6.2.2. Engine exhaust manifold shall be effectively insulated, so that the maximum external temperature, with ambient temperature 45°C shall not exceed:
 - a) 60°C in parts with access by personnel;
 - b) 200°C, for parts in contact with atmosphere and without access by personnel.
- 6.2.3. Insulation shall be done in a way to permit easy disassemble and reassemble after inspection/maintenance.
- 6.2.4. A silencer with integrated spark arrester shall be installed at discharge of diesel engine duct.
- 6.2.5. The exhaust shall be ducted out from the Unit by HULL CONTRACTOR including the whole system and all necessary accessories and additional components.
- 6.2.6. Exhaust system of engines with rated power equal to or above 600hp shall have sampling points to allow exhaust gases analysis.

6.3. STARTING SYSTEM

- 6.3.1. Two independent engine starting systems shall be included, being one electrical and other pneumatic, complying with starting cycle (cranking cycle) of NFPA 110.
- 6.3.2. The primary system shall be a 24VDC system as per 6.3.7. The back-up system shall be a pneumatic system as per 6.3.8. It shall be possible to select the starting system at AGCP (Auxiliary Generator Power and Control Panel) by means of a key-protected switch.
- 6.3.3. The 24VDC starting system shall be sized to allow at least 6 (six) consecutive starts. The pneumatic starting system shall be sized for at least 3 (three) consecutive starts. It shall be considered ambient temperature of 10°C, according to NFPA 110, to size the starting systems.

**TECHNICAL SPECIFICATION**

No. I-ET-3010.00-5262-700-P4X-001

REV. H

AREA:

SHEET: 14 of 54

TITLE:

**AUXILIARY GENERATOR PACKAGE FOR OFFSHORE
UNITS**

INTERNAL

ESUP

- 6.3.4. In case of failure after 3 (three) consecutive starting trials, AGCP shall sent an alarm signal to A&C, through Electrical System Automation and shall stop the automatic starting trials. In this situation operator shall look for problems and proceed with manual starts.
- 6.3.5. Auxiliary generator group shall be capable of being readily started in their cold condition. A fault or alarm in the marginal systems (pre-lube system, low start-up air pressure, and so on) shall not block motor automatic start.
- 6.3.6. Transmission of rotation from crankshaft to camshaft shall be effected through gearing.
- 6.3.7. Requirements for 24VDC starting systems (see also item 8.7.5):
- 6.3.7.1. This system shall comprise but not limited to the following items, supplied by PACKAGER:
- Auxiliary Generator Starting Battery-charger (CB-UG-5262501-02);
 - Auxiliary Generator Starting Battery (BT-UG-5262501-02) - 24VDC;
 - 24VDC starter motor;
 - Starter control circuitry located in AGCP.
- 6.3.8. Requirements for pneumatic starting systems:
- 6.3.8.1. This system shall comprise but not limited to, supplied by PACKAGER:
- Pressure control valve;
 - Pneumatic starting motor;
 - Start-up solenoid valve with manual by-pass;
 - Air filter;
 - Lubrication unit;
 - Breakdown and a blow down manual valves, installed in the start-up air line for depressurizing the line, right before the pneumatic starting motors, in the diesel motor skid, to prevent any accidental start of the motor during maintenance work.
- 6.3.8.2. The following parts of the system shall be supplied by HULL CONTRACTOR and shall comprise but not limited to:
- Air vessel (V-5138501) fitted with a manometer, two safety valves, inlet and outlet nozzles, vent, drain with purge unit, stop and by-pass valves, pneumatic pressure switch with low air pressure warning device (to AGCP) and port for inspection and cleaning;
 - Start-up Air Compressor Unit;
 - AISI 316L stainless steel starting pipes.
- 6.3.8.3. The air vessel of the Auxiliary Generator shall be supplied by the Start-up Air Compressor Unit of platform

	TECHNICAL SPECIFICATION	No. I-ET-3010.00-5262-700-P4X-001	REV. H
	AREA:	SHEET: 15 of 54	
	TITLE: AUXILIARY GENERATOR PACKAGE FOR OFFSHORE UNITS	INTERNAL	
ESUP			
<p>6.3.8.4. The Start-up Air Compressor Unit shall be capable of supplying compressed air for three consecutive start attempts of Auxiliary Generator, each one with 10 seconds long, in thirty minutes.</p> <p>6.3.8.5. The Start-up Air Compressor Unit shall be capable of supplying compressed air to other consumers if defined in Project Documentation.</p> <p>6.3.8.6. The pneumatic starting systems for motor-generators shall have the capacity to operate at a minimum pressure of 10 bar. Hull Contractor shall be responsible to select the final start-up air system pressure, according to requirements of Emergency Generator Unit, Auxiliary Generator Unit, and any other equipment supplied by this start-up air system, according to Project.</p> <p>6.4. COMBUSTION AIR SYSTEM</p> <p>6.4.1. Combustion air system shall be complete and shall contain at least the following accessories:</p> <ul style="list-style-type: none"> a) Charger air cooler; b) Inlet manifold; c) Dry type inlet air filters; d) Ducting and flexible connections, made of AISI 316L (fire-proofing); e) Suitably supported ducting and piping; f) Turbocharger, if necessary, with external bearings cooled by oil and with oil level sight-glass. If bearings are roller type, manufacturer shall indicate average guaranteed life, which shall exceed 20,000 hours; g) Air inlet shut-off valve for overspeed, with manual reset (diesel standard). <p>6.4.2. The air inlet of diesel engine shall be inside the room, but shall not take hot air exhausted from electrical generator cooler.</p> <p>6.5. COOLING SYSTEM</p> <p>6.5.1. Diesel engine shall be supplied with complete closed engine cooling water circuit including at least the following items of equipment:</p> <ul style="list-style-type: none"> a) Radiator, mounted at the generator skid. Radiator shall be inserted in Auxiliary Generator Room external bulkhead by HULL CONTRACTOR so that, with the generator in operation, no electrical fan is necessary for ventilation of the room and for package combustion and cooling system; b) Radiator fan, driven by the engine and sized large enough to maintain at a satisfactory level the engine operating temperature and to remove the whole of the heat dissipated at the maximum power level of the diesel engine; c) Centrifugal pump driven mechanically by the diesel engine for cooling water circulating in the closed circuit for engine. Belt driven pump shall not be accepted. d) System for pre-heating including electric resistor, if necessary; e) Thermostatic and three-way valves; 			

- f) Expansion tank for hot water and make-up water, complete with level gauge and flange for connection with piping for make-up water mounted on radiator;
- g) All piping, valves, filters, flexible connections and other accessories for interconnection of all equipment of cooling system;
- h) All instruments required for control and proper operation of diesel engine.
- 6.5.2. Emergency air intake and emergency air discharge dampers actuation shall be in accordance with HVAC PROJECT DOCUMENTATION.
- 6.5.3. The fail-safe condition for all dampers in Auxiliary Generator Room shall be fail-close.
- 6.5.4. HULL CONTRACTOR shall provide means to open the room dampers manually when the engine takes the emergency air inside the room.
- 6.5.5. PACKAGER shall inform the make-up consumption of water for cooling system.
- 6.5.6. Radiator fins and pipes shall be suitable for marine environment.
- 6.5.7. Radiator fan and dampers construction and installation (as well as all other devices) shall avoid entrance of external water (eg.: green water, rain, etc.) inside the room.
- 6.5.8. Equipment design shall take into account duct pressure loss due to room layout. Special attention to the required static pressure of radiator fan shall be given.

6.6. DIESEL OIL SYSTEM

- 6.6.1. Diesel Oil System shall comply with at least the following:
- a) Positive displacement mechanical injection pump, driven by diesel engine shaft, with injection nozzles for the various cylinders; oil main gears pump driven by engine shaft;
 - b) Manual priming pump for emergency use;
 - c) Flexible connection with fire-protection, built of AISI 316L stainless steel;
 - d) Dual filter with throwaway elements, with valves for reversing flow, continuous flow type;
 - e) Duplex type fuel filters, with insert replaceable without interrupting the fuel supply to the engine;
 - f) Water/oil separator filter;
 - g) Diesel oil daily tank (TQ-UG-5262501-01) containing at least the following accessories:
 - Port for inspection and cleaning;
 - Glass with heat resistant reflex type glass;
 - Breather with flame smothering device;
 - Drain with self-closing valve and device for collecting sample;
 - Nozzles for inlet, outlet and, if necessary, return of diesel oil;
 - Nozzle for overflow unit;
 - Low oil level pneumatic switch with warning unit on local panel;

- Level control valve;
 - Diesel oil feed blocking valve;
 - Support for nameplate;
 - Sounding pipe with stop valve and cap.
- h) All piping, valves, flexible connections and other accessories for interconnection of all equipment of diesel system.
- 6.6.2. The inner surface of the daily tank shall be cleaned to remove oxides and any residues prior the operation. The surface preparation shall be done using abrasive blast cleaning or chemical cleaning. The cleanness shall be maintained by using inhibitors or protective coatings. In any case the protective coating or inhibitor shall be compatible with diesel oil.
- 6.6.3. Tank capacity shall be designed for holding at least 18 hours of consumption at full load.
- 6.6.4. Diesel oil shut-off valve between daily tank and engine shall be fail-open type. A manual fuel valve between daily tank and engine shall be provided. It shall be possible to close this manual valve, outside the Auxiliary Generator room, in case of fire inside. This actuation shall be possible and not-dependant of any other system. The operation manoeuvre of this manual valve shall be located close to fire fighting push-button of the room.

6.7. LUBRICATION SYSTEM

- 6.7.1. Lubrication system shall be furnished and shall comply with, at least, the following:
- a) Gear-type main oil circulation pump driven by the engine shaft;
 - b) Hand-operated pre-lubrication auxiliary pump and oil pan drain;
 - c) Duplex lube oil filter of cartridge type with disposable elements. Filter cartridges shall be exchangeable without interrupting the oil supply to the engine;
 - d) All piping for interconnection, valves, drains and other auxiliaries inside the skid;
 - e) Filter on crankcase replenishment nozzle;
 - f) Pre-lubrication pump driven by AC electric motor, if the device is foreseen for the diesel engine model, and fed from AGCP;
 - g) Thermostatic valve or similar control device;
 - h) All instruments required for control and proper operation of diesel engine.
- 6.7.2. Engine shall have a dedicated lubrication unit.
- 6.7.3. In case of engines whose power rating calls for special precautions, PACKAGER must analyse the situation and tender, if necessary, for the following items:
- a) Pre-lubrication pump driven by induction motor, and fed from AGCP;
 - b) Lubricant oil heater, heated by fresh water from the closed-circuit of the engine pre-heating circuit and lube oil heater in order to maintain the lube oil circulating at a temperature keeping the engine in a “ready-to-start” condition;
 - c) Centrifugal separating filter (cyclone).

6.7.4. Tender shall indicate the time required between oil changes and the oil consumption.

6.7.5. Oil pressure shall be higher than cooling water pressure.

6.8. COUPLING AND TURNING DEVICE

6.8.1. The coupling between the diesel engine and the generator is to be flexible type. The criterion of sizing of the couplings shall be indicated by PACKAGER.

6.8.2. Coupling guard shall be rigid enough to avoid contact with moving parts.

6.8.3. The engine shall be provided with safe turning device for purposes of inspection and maintenance (tool furnished loose).

6.9. VIBRATION LIMITS AND ISOLATION

6.9.1. Acceptable limits of vibration valour, at engine casing, in any direction, are:

- a) in the casing, in bearing: 11.0 mm/s RMS;
- b) in the casing, on the top of cylinders: 11.0 mm/s RMS.

6.9.2. Maximum vibrations levels allowed to be transmitted to the structure shall be according to limits of Category V defined in I-ET-3010.00-1200-300-P4X-001 - NOISE AND VIBRATION CONTROL REQUIREMENTS.

6.9.3. Isolation of vibration shall be part of noise control.

6.9.4. Skid shall be fixed to the structure by means of a resilient support, in order to limit the static deflection in 10mm, distributed symmetrically in relation to the engine gravity center.

6.9.5. Metallic isolators shall be installed, mesh type or not, with natural frequency between 3Hz and 9Hz and stabilizers of single or double effect, in exhaust duct.

6.9.6. PACKAGER shall inform the following data:

- a) Type of vibration isolator to be used;
- b) Static deflection of the isolator;
- c) Transmissibility of the isolator;
- d) Dynamic response analyses of assembly, with 6 degrees of freedom;
- e) Manufacturer, model and quantity of isolators to be installed.

6.9.7. Torsional vibration analysis shall be provided. Dynamic stresses transmitted to foundations shall be reduced to almost zero values. When forces or moments not taken into account in design occur in the engine, provision shall be made for a system for damping vibrations with elastic suspension suitable for reducing vibration to a minimum level in all speed ranges from the self-sustained level to 120% of operating speed. PACKAGER shall present a study containing selection of the type of suspension and maximum amplitudes of vibration of the skid, expected to occur during operation (values shall be guaranteed by PACKAGER).

6.10. SUPPORT SKID

6.10.1. One common skid base shall be provided by PACKAGER for both the diesel engine and the generator, with the diesel engine mounted on vibration pads.

- 6.10.2. A drip pan with a 2" drain connection shall be integrated in the support skid. The drain connection shall be combined with the day tank drip pan connection to one common drain to outside.
- 6.10.3. The skid shall be equipped with minimum two (2) M10 grounding stud bolt connectors welded at each corner (in recess) of the structure.
- 6.10.4. Package internal safety grounding system (equipment, accessories, piping and structure) shall comply with the requirements of IEC 61892-6, IEC 60092-502, I-ET-3010.00-5140-700-P4X-001 - SPECIFICATION FOR ELECTRICAL DESIGN FOR OFFSHORE UNITS, I-DE-3010.00-5140-700-P4X-003 - GROUNDING INSTALLATION TYPICAL DETAILS and applicable Classification Society rules.
- 6.10.5. The skid shall be equipped with approved lifting eyelets.
- 6.10.6. The skid shall be welded to the floor after installation in the generator room.

7. ELECTRICAL GENERATOR

7.1. GENERAL

- 7.1.1. The electrical generator shall be synchronous, with a brushless PMG exciter, and shall be constructed according to IEC 60034-1. Generator shall comply with IEC 61892-3 and applicable Classification Society rules.
- 7.1.2. Generator rated voltage shall be 480Vac or 690Vac in accordance with Project Documentation, 3 phases, 60Hz. Unless otherwise stated, the rated power factor shall be 0.8.
- 7.1.3. The generator shall be protected against the corrosion caused by the humidity, oil vapours, and marine atmosphere characteristic of the site of installation.
- 7.1.4. The generator, the exciter and the auxiliary systems shall be suitable for operating continuously at full load condition during the period of time compatible with that of the driving machine, and no lower than 10,000 hours.
- 7.1.5. The generator shall be capable of supplying their rated output at rated speed and at rated power factor at a voltage variation range between 95% and 105% of their rated voltage.
- 7.1.6. The generators shall be capable of operating continuously on an unbalanced system in such a way that, with none of the phase currents exceeding the rated current, the ratio of the negative-sequence current component to the rated current does not exceed the values stated in IEC 60034-1.
- 7.1.7. The generator shall be capable of supplying their rated output at rated speed and at rated power factor at a voltage variation range between 95% and 105% of their rated voltage.
- 7.1.8. When operating under rated load, generators shall be designed to comply with the total and individual voltage harmonic distortion limits required in IEC 61892-1.
- 7.1.9. When operating under rated load, generators shall be capable of withstanding currents having a harmonic current factor (HCF) of, at least, 5%, as required in IEC 60034-1.
- 7.1.10. The generator shall be designed with damper winding to permit parallel operation.
- 7.1.11. The generator shall be designed and manufactured in order to facilitate extraction of the rotor in the horizontal direction without removal of the stator.

- 7.1.12. The generator shall withstand for 30 seconds a current value equivalent to at least 150% of the rated value.
- 7.1.13. Generator with its exciter shall be capable of maintaining a short-circuit current of at least three times its rated value for at least 2 seconds.
- 7.1.14. Generators and their exciters shall be dynamically balanced and capable of withstanding an overspeed of 20% above the rated value for 2 minutes.
- 7.1.15. The Frequency Regulation limits, in continuous and transient conditions shall comply with:

- Steady-state $\pm 1,5\%$ ⁽³⁾ ⁽²⁾
- Transient $\pm 10\%$ ⁽¹⁾
- Transient recovery frequency $\pm 5\%$ ⁽¹⁾
- Transient maximum recovery time 3s ⁽¹⁾

Notes:

- 1) related to rated frequency (IEC 61892-3);
- 2) for all loads from zero to rated load at rated power factor;
- 3) related to rated frequency (ISO 8528-5).

- 7.1.16. The generator shall have IP54 protection degree.
- 7.1.17. Auxiliary Generator reactances shall be defined in order to keep the short-circuit current in Auxiliary Switchgear within the limits defined by I-ET-3010.00-5140-700-P4X-001 - SPECIFICATION FOR ELECTRICAL DESIGN FOR OFFSHORE UNITS when Auxiliary Generation is in parallel operation with Main Generation, when Auxiliary Generation is in parallel operation with Emergency Generation and when Auxiliary Generation is in parallel operation with Generic Generation, if any additional generic generator package is foreseen in Project Documentation.

7.2. EXCITATION

- 7.2.1. The thermal insulation class of the exciter shall be identical to the generator's insulation class.
- 7.2.2. The generator shall have a brushless type rotating exciter. The primary supply voltage for the excitation system shall be obtained from a permanent magnet generator (PMG).
- 7.2.3. The rotating rectifying unit shall be supervised by a system for detecting and alarm a fault in rectification (damaged or short-circuited diodes).
- 7.2.4. Excitation shall be disconnected if a fault remains after disconnection of generator's circuit-breaker.
- 7.2.5. The complete excitation system shall be sized to provide a positive ceiling voltage of exciter equal to or greater than 200% of the rated field voltage with the generator at full load for at least 2 seconds.
- 7.2.6. The complete excitation system shall be able to sustain and, therefore, withstand the following generator overcurrent conditions:
- 300% of stator rated current for 2 s under a three-phase short-circuit at the generator terminals;

- 150% of stator rated current, with rated power factor, for 30 s.

- 7.2.1. The manufacturer of generator shall supply both, voltage and current transformers, and they shall be part of the excitation system.
- 7.2.2. The exciter terminals shall be connected in an exclusive terminal box, not containing circuits for other purposes.
- 7.2.3. The exciter shall have inspection windows large enough for replacement of diodes.

7.3. INSULATION

- 7.3.1. The stator winding system, including connections, end windings and terminal lead extensions, shall be supported, wedged and braced to prevent insulation cracking. Bracing, blocking and wedging shall be suitably secured to withstand the vibration and forces during the required lifetime of the machine.
- 7.3.2. All generators windings shall have vacuum impregnated insulation, and shall be treated to resist moisture, marine atmosphere, and oil vapours.
- 7.3.3. The generators insulation thermal class shall be “F”, with maximum temperature rise corresponding to class “B”.
- 7.3.4. The internal insulation materials shall be flame retardant and non-hygroscopic. Cables for interconnection of stator with the outgoing terminals, if used, shall also have these characteristics, and shall be with double silicone insulation.
- 7.3.5. The generator windings shall withstand indefinitely, without restriction for its useful lifetime, the phase-to-phase rated voltage between any phase to ground.

7.4. BEARINGS

- 7.4.1. Lubrication shall be effective under all operating conditions, including inclination variations (static and dynamic) referred on item 4.3.
- 7.4.2. Bearings shall be fitted with sealing devices in order to prevent leakage of lubricant inner and outer side of the generator, and to prevent ingress of water or moisture.
- 7.4.3. Bearing shall be electrically insulated. A shorting device shall be provided in the bearing housing on the drive end. For double-end drivers, the coupling on one end also shall be electrically insulated and the bearing housing shorting device provided on the opposite end. Means shall be provided to avoid the circulation of currents between the shaft and the bearings (see IEC 60034-25 as reference).
- 7.4.4. Inlet piping for oil lubricated bearing shall have siphons before inlet points to avoid lube oil vapour ingress inside generator. The lube oil return to lube oil tank shall be soft, to avoid formation of bubbles and foam.

7.5. COOLING SYSTEM

- 7.5.1. The generator shall be self-ventilated, using air as cooling medium and not dependant on other systems (IC411, or IC511, or IC611, according to IEC 60034-6). The cooling air shall be impelled by fans mounted on the shaft of the generator rotor.

7.6. TERMINALS

- 7.6.1. The generator shall have six accessible power terminals, installed in order to facilitate the work of cables installation and maintenance.
- 7.6.2. All power terminals shall be insulated up to the connection point and the latter shall be silver coated. They shall be suitable for withstanding the thermal and dynamic effects imposed on them under any conditions of load or short-circuit and vibrations.
- 7.6.3. The terminals of control circuits shall be eyelet type, to avoid slackening with the vibration.
- 7.6.4. The generator shall be supplied with grounding terminals located outside the casing.

7.7. TERMINAL BOXES

7.7.1. General Requirements

- 7.7.1.1. The generator shall be fitted with independent terminal boxes sized for housing the terminals for power, neutral and control cables. The control cables shall be grouped together in terminal blocks and suitably identified. Power Terminal Box, Neutral Terminal Box and Auxiliary Boxes shall be integral part of the generator and independent from each other.
- 7.7.1.2. The connection boxes shall be fitted with removable plates for cables entries, made of the following materials:
- AISI 316L stainless steel for sheets intended for the running of single-phase power cables;
 - Epoxy painted galvanized steel sheet for other cases.
- 7.7.1.3. Terminal boxes shall have enough space for entry, bending and terminations of cables in cross section and quantity indicated on Data Sheet. Each box shall be capable to withstand the mechanical stresses due to cables weight, especially when there are a large number of cables.
- 7.7.1.4. All terminal boxes shall be sized so that in case of short-circuit or surge protection failure inside the unit there shall be no risk to people and equipment in the neighbourhood.
- 7.7.1.5. All terminal boxes shall be identified with an AISI 316L stainless steel nameplate with tag and function description.
- 7.7.1.6. Terminal boxes shall have minimum protection degree IP54W (where W means suitable for saline, corrosive, hot and damp environment).

7.7.2. Power Terminal Box

- 7.7.2.1. The Power Terminal Box shall have enough space for:
- lightning-arresters and capacitors for surge protection, according to PACKAGER standard;
 - metering and protection voltage transformers.
- 7.7.2.2. The Power Terminal Box shall be suitable for outdoor installation and under environmental conditions. The cables entries shall be at bottom side.



7.7.2.3. The Power Terminal Box shall permit access from the front side. It shall not be possible to open the box without the use of tools.

7.7.3. Neutral Terminal Box

7.7.3.1. The protection and control current transformers shall be installed inside the Neutral Terminal Box. See Figure 1.

7.7.3.2. The Neutral Terminal Box shall have the same construction and installation characteristics of the Power Terminal Box.

7.7.3.3. It is acceptable the use of a common Terminal Box for power and neutral terminals, since there is enough space for all internal components.

7.7.4. Auxiliary Terminal Boxes

7.7.4.1. All cables terminals for RTDs, space heaters, exciter, voltage transformers, current transformers and other auxiliary instruments shall be driven to specific auxiliary terminal boxes.

7.7.4.2. Except for the size, the auxiliary terminal boxes shall have the same construction and installation characteristics of the Power Terminal Box.

7.8. TEMPERATURE DETECTORS

7.8.1. Two (2) winding temperature detectors (platinum resistance RTDs, three-wire 100Ω at 0°C) per phase shall be supplied, for metering and alarm.

7.8.2. These detectors shall be suitably distributed between the stator slots so that the cooling air will not directly affect them.

7.8.3. Wiring for all temperature detectors shall be connected to an exclusive auxiliary terminal box.

7.8.4. Each bearing shall have two temperature detectors (platinum resistance RTDs, three-wire 100Ω at 0°C).

7.8.5. AGCP shall have a temperature indicator, with selector switch for RTD's of windings and bearing.

7.9. SPACE HEATERS

7.9.1. The space heaters of generator shall operate in such a manner that the internal environmental temperature is higher than the environmental design temperature, up to a maximum limit of 10°C above surrounding temperature.

7.9.2. The heating resistors shall be "shielded" type, with rated voltage of 220VAC, isolated, two phases and shall be protected by 2 pole circuit-breakers. A notice board shall be posted up in the vicinity of the connection box bearing the words "ATENÇÃO - AQUECEDOR LIGADO EM 220 VCA" (Attention - Heater connected in 220 VAC).

7.9.3. The resistors shall be fed by Auxiliary Switchgear incoming circuit-breaker functional unit. AGCP shall send a discrete signal to this functional unit, in order to turn off the generator heating resistors when the generator is running. The generator heating resistors shall remain energized while the generator is stopped, causing no damage to the windings and internal parts, and shall be automatically turned off when the generator is operating.

7.10. WIRING

- 7.10.1. Conductors connected to current transformers shall be linked up with terminals permitting short-circuit.
- 7.10.2. The wiring coming from voltage transformers and other normally energized sources shall be connected up to protected terminal blocks containing a notice that they may be energized ("ATENÇÃO - TERMINAIS ENERGIZADOS").

7.11. GROUNDING SYSTEM

- 7.11.1. For installation in FPSO and FSO, the Auxiliary Generator neutral point shall be isolated from ground.
- 7.11.2. For installation in semi-submersible and fixed Units, the Auxiliary Generator neutral shall be grounded by high resistance. See PROJECT ONE-LINE DIAGRAM.

7.12. NAMEPLATES

- 7.12.1. The Generator nameplate shall be in AISI-316L stainless steel, containing the following data:
- a) Petróleo Brasileiro S.A. - PETROBRAS;
 - b) Nome do fabricante (manufacturer's name);
 - c) Número de série, código de data (serial number, date code or other indication making it possible to recognize the type of manufacture);
 - d) Potência nominal (rated power);
 - e) Tensão nominal (rated voltage);
 - f) Corrente nominal (rated current);
 - g) Reatância transitória de eixo direto, não saturada (direct transient reactance, non saturated);
 - h) Reatância subtransitória de eixo direto, saturada (direct sub-transient reactance, saturated);
 - i) Frequência nominal (rated frequency);
 - j) Número de fases (number of phases);
 - k) Sequência de fases (phase sequence);
 - l) Rotação nominal (rated r.p.m.);
 - m) Classes de temperatura dos isolamentos ou limites de elevação de temperatura (para rotor e estator) (insulation temperature classes or temperature rise limits (for rotor and stator));
 - n) Conexão das bobinas (connections of windings, indicated by symbols);
 - o) Fator de potência nominal (rated power factor);
 - p) Grau de proteção (protection degree);
 - q) Temperatura ambiente de projeto (environmental temperature);

	TECHNICAL SPECIFICATION	No. I-ET-3010.00-5262-700-P4X-001	REV. H
	AREA:	SHEET: 25 of 54	
	TITLE: AUXILIARY GENERATOR PACKAGE FOR OFFSHORE UNITS	INTERNAL	
ESUP			
<p>r) Pesos de rotor, estator e trocador de calor (weight of rotor, stator and heat exchanger in kilograms).</p> <p>7.12.2. Diesel engine nameplate shall have the necessary data to calculation of fugitive emissions according to API 42.</p> <p>7.12.3. Nameplates made of material resistant to corrosion and humidity shall be applied for identification and location of all electric equipment, panels, relays, meters and terminal boxes.</p> <p>7.12.4. Nameplates shall have black lettering engraved in bas-relief against a white background, except those referring to alarm signals and hazards, which shall have white lettering on a red background.</p> <p>7.12.5. All rotary equipment shall be fitted with corrosion-resistant metallic plates attached with metallic rivets.</p> <p>7.12.6. Information indicated on nameplates shall be submitted to PETROBRAS for approval.</p> <p>7.12.7. All safety signalling and IHM controls shall be in Portuguese language as required by NR-12.</p> <p>8. CHARACTERISTICS OF ELECTRICAL PANELS AND EQUIPMENT</p> <p>8.1. GENERAL CHARACTERISTICS</p> <p>8.1.1. Panels shall have IP42W protection degree (W means suitable for corrosive, saline, hot and damp environment).</p> <p>8.1.2. All accessories and components shall be immune to and protected from electromagnetic and radio-frequency interference (EMI-RFI). The panels and all their components shall comply with requirement for emission immunity stated in IEC 60533, presenting performance criterion A.</p> <p>8.1.3. All metallic parts belonging to the panel and not intended to carry current shall be connected with the panels grounding busbar. The busbar shall be inside the panel and be fitted with suitable "non-welded" type connectors for gauge according to [4] at each end.</p> <p>8.1.4. The partitioning of panels shall use metallic barriers, at least in the 2a form of IEC 61439-1, separating the live power entry terminals and the circuit-breaker from the remainder de-energized parts after disconnection of circuit-breaker.</p> <p>8.1.5. In order to separate the risk zone (power circuits) and to avoid human contact with live parts, as stated in NR-10 rules, insulated and transparent polycarbonate barriers shall be installed. Totally screwed plates shall not be used. Alert indicating plates shall be provided, with the indication of risk and the rated voltage of circuits, as stated in NR-10.</p> <p>8.1.6. The panel shall be fitted with heating elements (one to each vertical section or compartment, where closed into itself), operating at 220VAC, isolated, two phases and shall be protected by 2 pole circuit-breakers with external energy supply. These heaters shall be automatically controlled by means of thermostats with graduation range up to a maximum of 60°C. The circuit of each heater shall have a circuit-breaker intended to protect the circuit.</p>			

- 8.1.7. The panel shall be provided with an external socket for energizing the heating circuits during the storage period. This socket shall have the following label:

**TERMINAIS PARA ENERGIZAÇÃO DAS
RESISTÊNCIAS DE AQUECIMENTO**

- 8.1.8. Panels shall be factory-mounted type and shall be equipped with hoisting devices at the top.
- 8.1.9. The maximum height, including the skid, shall not exceed 2400mm. Panel shall be self-supported. The steel sheet thickness shall be of at least 1.98mm (14 USG).
- 8.1.10. The panels shall be drilled with holes to permit its attachment to the additional steel base (skid).
- 8.1.11. The cables entrance shall be according to installation criteria defined for the room. See project documentation.
- 8.1.12. Panels and its interfaces shall be designed following the requirements stated on I-ET-3010.00-5140-700-P4X-005 - REQUIREMENTS FOR HUMAN ENGINEERING DESIGN FOR ELECTRICAL SYSTEMS OF OFFSHORE UNITS.

8.2. AUXILIARY SWITCHGEAR

- 8.2.1. The Auxiliary Switchgear shall be supplied by HULL CONTRACTOR. The generator protection shall actuate on the incoming generator circuit-breaker at this panel.
- 8.2.2. Undervoltage relays installed at Auxiliary Switchgear shall send discrete signals to automatically start the Auxiliary Generator.

8.3. AUXILIARY GENERATOR POWER AND CONTROL PANEL (AGCP) (PN-UG-5262501-01)

- 8.3.1. The Auxiliary Generator Power and Control Panel (AGCP) shall contain the Auxiliary Generator controller devices (manual start and stop commands, manual voltage and frequency adjustment commands, operation mode selection (automatic / manual / blocked), the protective relays, the synchronism board for manual operation (switches, lamps, metering, etc.) and the necessary starters for electrical auxiliary equipment (battery-chargers, cooling fans, lube pumps, HPUs, heating equipment, etc.).
- 8.3.2. The Auxiliary Generator Power and Control Panel (AGCP) (PN-UG-5262501-01) shall comply with requirements of I-ET-3010.00-5140-741-P4X-004 - SPECIFICATION FOR LOW-VOLTAGE GENERIC ELECTRICAL PANELS FOR OFFSHORE UNITS.
- 8.3.3. The control voltage shall be 24VDC. See 8.7.5.
- 8.3.4. The Auxiliary Generator Power and Control Panel (AGCP) shall be able to control ventilation and radiators dampers of Auxiliary Generator Room. The control shall be connected to 24Vcc local source.

8.4. AUTOMATIC VOLTAGE REGULATOR (AVR)

- 8.4.1. Automatic Voltage Regulator AVR shall be micro processed type, last PACKAGER generation, mounted on a steel chassis suitable for assembly inside AGCP.
- 8.4.2. The regulator shall be proper for offshore conditions and shall be capable of operating under all specified condition of steady state and transient load, including short-circuits.
- 8.4.3. The regulator shall be suitable for operation in parallel with other machines of different ratings.
- 8.4.4. The AVR shall provide means for manual and automatic adjustment of voltage through the manual-automatic switch, internal to AGCP.
- 8.4.5. The reactive load sharing (when generator is running in parallel with other machines) shall be done through the droop characteristics of the generator Automatic Voltage Regulator.
- 8.4.6. The voltage drop in the generator terminals shall not be higher than 15% on the start-up of the biggest motor. The motor data and initial load shall be specified on Data Sheet.
- 8.4.7. The AVR shall have at least the following functions:
- Under-excitation limiter;
 - Over-excitation limiter;
 - Field overcurrent limiter;
 - Field overvoltage limiter;
 - Rotating diodes monitoring;
 - Soft ramp-up, for gradual increase of generator voltage during start-up.
- 8.4.8. The AVR shall be provided with internal register of events, variables and protection functions.
- 8.4.9. The AVR shall have a HMI to allow reading of variables, events, registers and to allow configuration of parameters. The HMI shall have password access for changing in configuration parameters.
- 8.4.10. It shall be provided the configuration and parameters and registers reading software for the AVR (compatible with Microsoft Windows). The software shall be furnished in their most recent versions at purchase time, including licensing, installation media(s) and manuals, as well as with one year of technical support and maintenance. Demo versions and under development shall not be accepted.
- 8.4.11. The AVR shall be connected to Electrical System Automation only for supervision and remote configuration, according to I-DE-3010.00-5140-797-P4X-001 - ELECTRICAL SYSTEM AUTOMATION ARCHITECTURE DIAGRAM and I-ET-3010.00-5140-797-P4X-001 - ELECTRICAL SYSTEM AUTOMATION ARCHITECTURE. The access shall be controlled by password.
- 8.4.12. The AVR shall comply with interface signals defined in I-LI-3010.00-5140-797-P4X-001 - ELECTRICAL SYSTEM AUTOMATION INTERFACE SIGNALS LIST.
- 8.4.13. Auxiliary Generator shall comply with the following static and dynamic performance requirements.

8.4.14. The Voltage Regulation limits, in continuous and transitory conditions shall comply with:

- Steady-state $\pm 2.5\%$ ^{(1) (2)}
- Transient -15% to +20% ⁽¹⁾
- Transient recovered voltage $\pm 2.5\%$ ⁽¹⁾
- Maximum transient recovery time 1.5s ⁽¹⁾

Notes:

- 1) related to rated voltage (IEC 61892-3);
- 2) for all loads from zero to rated load at rated power factor (IEC 61892-3).

8.4.15. For details about step of loads for tests, see IEC 61892-3 and Classification Society rules.

8.5. AUXILIARY GENERATOR CONTROLLER (AGC)

8.5.1. The Auxiliary Generator Power and Control Panel (AGCP) shall be designed with a unique dedicated microprocessor-based device, hereafter called Auxiliary Generator Controller (AGC). AGC shall be a controller dedicated to Auxiliary Generator Package control, shall be certified for marine offshore use and shall be approved by PETROBRAS. AGC shall be a controller dedicated to moto-generator units, being necessary only parameterization of standard data for operation. It shall not be accepted use of PLC or customized controllers for AGC.

8.5.2. The AGC shall be installed in AGCP and shall be responsible for:

- a) Control generator and diesel engine.
- b) Automatic Synchronism and smooth load transfer;
- c) Reply engine status and protections coming from engine local control panel.

8.5.3. There shall be a selector switch to choose the active load control of Auxiliary Generator (Isochronous / Droop / Base Load).

8.5.4. In isolate operation the active power control mode shall be selected between Isochronous (following frequency set-point - 60Hz) or Droop (active power according to frequency x power droop characteristic of governor). There shall be internal interlock in AGCP to prevent selection of Base Load mode (despite of selector switch position) when Auxiliary Generator is operating isolated.

8.5.5. The AGC shall have internal clock synchronized with external signal according to I-DE-3010.00-5140-797-P4X-001 - ELECTRICAL SYSTEM AUTOMATION ARCHITECTURE DIAGRAM and I-ET-3010.00-5140-797-P4X-001 - ELECTRICAL SYSTEM AUTOMATION ARCHITECTURE.

8.5.6. The AGC shall comply with interface signals defined in I-LI-3010.00-5140-797-P4X-001 - ELECTRICAL SYSTEM AUTOMATION INTERFACE SIGNALS LIST.

8.5.7. The main interfaces between the AGCP and others devices are shown in Figure 1. Other interface signals exist, according to each interface equipment and according to project necessity. PACKAGER shall supply all necessary interface signals.

**TECHNICAL SPECIFICATION**

No. I-ET-3010.00-5262-700-P4X-001

REV. H

AREA:

SHEET: 29 of 54

TITLE:

**AUXILIARY GENERATOR PACKAGE FOR OFFSHORE
UNITS**

INTERNAL

ESUP

- 8.5.8. The AGCP shall receive an ESD (Emergency Shutdown) signal from A&C. This signal stop the Auxiliary Generator and shall carry all auxiliary loads for safe condition.
- 8.5.9. It shall be possible to start operation of the Auxiliary Generator group manually, totally independent from the AGC. In order to start the Auxiliary Generator set, without blocking from AGC protections and interlocks, a switch (AGC / MANUAL) to transfer the control from AGC to manual commands shall be provided. This switch shall override also the external ESD signal. In MANUAL position, only the protections of the diesel engine (installed at Engine Local Control Panel), the electrical protections (installed on protection relay external to AGC), and manual commands shall be able to stop the Auxiliary Generator set. There shall be label in this control switch with the following text “**Atenção! Na posição Manual o sinal de ESD e várias proteções são desativadas. Usar apenas para partidas controladas com avaliação dos riscos**”.
- 8.5.10. PACKAGER shall supply documents proving that the same model of AGC have been installed in offshore environment at least for two years in similar situations, without developing any kind of problem.

ISOLATED NEUTRAL SYTEM

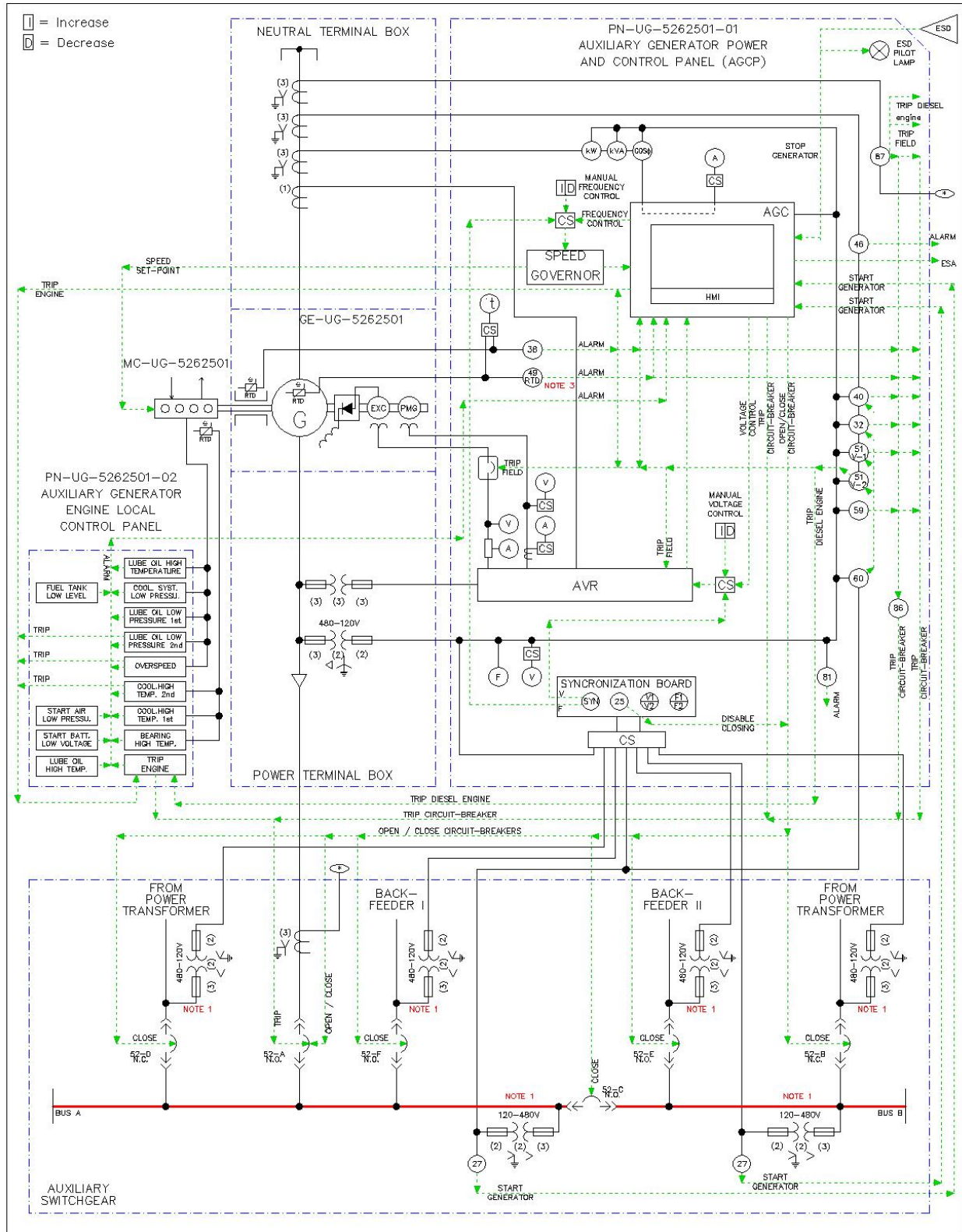

Figure 1 - Typical Protection and Communication Diagram – Isolated System

**TECHNICAL SPECIFICATION**

No. I-ET-3010.00-5262-700-P4X-001

REV. H

AREA:

SHEET: 31 of 54

TITLE:

**AUXILIARY GENERATOR PACKAGE FOR OFFSHORE
UNITS**

INTERNAL

ESUP

- Notes:
- 1 VTs shall be connected to the same phases, to allow synchronization control;
 - 2 This diagram does not show all details of these equipment;
 - 3 Auxiliary switchgear configuration may be different for each project. See PROJECT ONE-LINE DIAGRAM;
 - 4 If any additional Generic Generator Package is foreseen in Project Documentation and Generic Generator Switchgear is connected to Auxiliary Switchgear through back-feeder, AGCP shall be able to control back-feeder circuit-breakers in order to perform parallel operation between Auxiliary Generator and Generic Generator.
 - 5 GGCP shall be able to control Generic Generator circuit-breaker, input transformers circuit-breakers, tie circuit-breaker and back-feeders circuit-breakers connected to other generators switchgears in accordance with Project Documentation.
 - 6 For Generic Generator Switchgear information see Project Documentation

8.6. AUXILIARY GENERATOR ENGINE LOCAL CONTROL PANEL (PN-UG-5262501-02)

- 8.6.1. The diesel Auxiliary Generator Engine Local Control Panel shall include the engine protection and indication devices.
- 8.6.2. Communication between the Auxiliary Generator Engine Local Control Panel and AGCP, for transfer of monitoring signals, shall be provided, according to PACKAGER standard.
- 8.6.3. The control voltage shall be 24VDC. See 8.7.5.

8.7. STARTING AND INTERLOCKING

- 8.7.1. The AGCP shall receive the starting signal (“Loss of the Mains”) from the Auxiliary Switchgear undervoltage relays (27 function), but the Auxiliary Generator circuit-breaker in the switchgear shall be closed manually, by operator, after the starting sequence. See PROJECT ONE-LINE DIAGRAM for details (not applicable to Generic Generators).
- 8.7.2. The AGCP shall be interconnected to Auxiliary Switchgear to implementation of the foreseen interlocks. See PROJECT ONE-LINE DIAGRAM.
- 8.7.3. The automatic starting process shall not last more than 45s (not applicable to Generic Generators).
- 8.7.4. An emergency shutdown (ESD) discrete signal from the Fire & Gas System (FGS), in case of confirmed gas in Auxiliary Generator room emergency air intake (emergency air intake is different from normal air intake) or confirmed fire inside the room shall be sent to:
 - AGCP to inhibit the starting process of the generator when it is stopped. If the generator is running, this signal shall stop the generator set. A pilot lamp shall be provided at AGCP indicating the status of this signal.
 - HVAC system to close the ventilation damper (emergency air intake and emergency air discharge) of the room.
- 8.7.5. The fail-safe condition of the external ESD shall block (stop) operation of Auxiliary Generator.
- 8.7.6. Other signals are detailed in I-LI-3010.00-5140-797-P4X-001 - ELECTRICAL SYSTEM AUTOMATION INTERFACE SIGNALS LIST.

8.8. BATTERY AND BATTERY-CHARGERS

- 8.8.1. Separated sets of battery and battery-chargers for control voltage (CB-UG-5262501-01 - Auxiliary Generator Control Battery-charger and BT-UG-5262501-01 - Auxiliary Generator Control Battery, for AGCP supply) and starting system (see 6.3) shall be provided. Battery for control voltage shall also be charged by the shaft-driven alternator.
- 8.8.2. The autonomy of batteries for control voltage when not charging from its battery-charger or shaft-driven alternator shall be at least 30 min.
- 8.8.3. As an alternative to shaft-driven alternator, a 100% redundant battery set charger for control voltage will be acceptable.
- 8.8.4. Battery-chargers and batteries shall comply with I-ET-3010.00-5140-773-P4X-002 – SPECIFICATION FOR GENERIC D.C. UPS FOR OFFSHORE UNITS and I-ET-3010.00-5140-714-P4X-001 - SPECIFICATION FOR ELECTRICAL BATTERIES FOR OFFSHORE UNITS.
- 8.8.5. Battery-chargers shall be suitable for 480Vac or 690Vac according to Project Documentation, 3ph/60Hz power supply, unless otherwise stated in Project Documentation, complete with metering (charging current & voltage), mounted inside AGCP or in an IP42 minimum enclosure and fed from AGCP.
- 8.8.6. Battery-chargers shall provide one UAM alarm signal through voltage free contact (1A @ 24VDC) to be sent to A&C, by AGCP (included in AGCP UAM summary) through Electrical System Automation. This alarm signal shall include at least battery in discharge and low resistance isolation.
- 8.8.7. Batteries shall be located in a dedicated battery box. Sealed or VRLA type batteries shall not be used (based on IEC 61892-3).

9. PROTECTION

9.1. PROTECTIVE RELAYS

- 9.1.1. Protective and lockout relays shall comply with requirements of I-ET-3010.00-5140-700-P4X-002 - SPECIFICATION FOR ELECTRICAL MATERIAL FOR OFFSHORE UNITS.
- 9.1.2. Protective relay shall be connected to Electrical System Automation through fast Ethernet IEC 61850 network. See I-DE-3010.00-5140-797-P4X-001 - ELECTRICAL SYSTEM AUTOMATION ARCHITECTURE DIAGRAM and I-ET-3010.00-5140-797-P4X-001 - ELECTRICAL SYSTEM AUTOMATION ARCHITECTURE.
- 9.1.3. Auxiliary generator package shall transfer to ESA all oscillography records, data logger files, event records and alarms generated by the emergency generator package devices (AVR, IEDs, controllers, etc) and motor controllers. Data shall be available in the auxiliary generator memory map. Switches shall be supplied in order to provide communication according to the document I-DE-3010.00-5140-797-P4X-001 - ELECTRICAL SYSTEM AUTOMATION ARCHITECTURE DIAGRAM.
- 9.1.4. The electrical automation system shall be allowed to access and collect all the historical data mentioned in item 9.1.3

9.1.5. Controllers, AVRs and protective relay of Auxiliary Generator shall have its internal clock synchronized with Electrical System Automation Time Server through the time protocol according to I-ET-3010.00-5140-797-P4X-001 - ELECTRICAL SYSTEM AUTOMATION ARCHITECTURE. All devices with logging or communication capabilities internal to the Auxiliary Generator shall have its internal clock synchronized with Electrical System Automation. PACKAGER is responsible to provide means of synchronization among internal components which are not connected to Electrical System Automation networks. All other internal devices connected to Electrical System Automation networks shall be synchronized with the Electrical System Automation Time Server through the time protocol according to I-ET-3010.00-5140-797-P4X-001 - ELECTRICAL SYSTEM AUTOMATION ARCHITECTURE and I-DE-3010.00-5140-797-P4X-001 - ELECTRICAL SYSTEM AUTOMATION ARCHITECTURE DIAGRAM. All events and alarms shall be logged in the equipment with the time stamp synchronized with the internal clock, which shall be synchronized with the Electrical System Automation Time Server.

9.2. PROTECTION

- 9.2.1. The protection of Auxiliary Generator and the Diesel Engine shall comply with I-ET-3010.00-5143-700-P4X-001 - ELECTRICAL SYSTEM PROTECTION CRITERIA.
- 9.2.2. Detection of ground fault in power circuits in Auxiliary Generator Power and Control Panel (AGCP) circuits shall be executed using portable ground fault detector supplied by BIDDER.
- 9.2.3. Control voltage circuits shall have insulation monitoring device (IMD), sending ground fault alarm to A&C through Electrical System Automation.
- 9.2.4. All outgoing circuits shall be installed in a way to enable easy access to clamp them with the portable ground fault detector, with the circuits energized. The shields shall be installed according to detector.
- 9.2.5. Diesel Engine Protection shall comply with Classification Society and Table 2:

Table 2 - Diesel Engine Protections

Protection	Trip Diesel Engine	Alarm
Lubrication Oil Low Pressure (1 st stage)		X
Lubrication Oil Very Low Pressure (2 nd stage) (1)	X	X
Lubrication Oil High Temperature		X
Overspeed	X	X
Diesel Daily Tank Low Level		X
Cooling Water High Temperature (1 st stage)		X
Cooling Water Very High Temperature (2 nd stage) (1)	X	X
Cooling Water Low Pressure		X
Starting Air Low Pressure		X



AREA:

SHEET: 34 of 54

TITLE:

**AUXILIARY GENERATOR PACKAGE FOR OFFSHORE
UNITS**

INTERNAL

ESUP

Protection	Trip Diesel Engine	Alarm
Starting Batteries Low Voltage		X
Leakage from Pressure Pipes		X
Any Other Protection		X

Note 1: Trips of “Lubrication Oil Very Low Pressure” and “Cooling Water Very High Temperature” protections shall be confirmed by actuation of two (2) sensors in series.

9.3. CURRENT TRANSFORMERS (CTs) AND VOLTAGE TRANSFORMERS (VTs)

- 9.3.1. The generator manufacturer shall define and supply the CTs and VTs to allow the perfect operation of control, protection and excitation devices linked to the generator. Current transformers and voltage transformers shall comply with I-ET-3010.00-5140-700-P4X-002 - SPECIFICATION FOR ELECTRICAL MATERIAL FOR OFFSHORE UNITS.
- 9.3.2. CTs and VTs shall be dry type and shall be separated for excitation systems.
- 9.3.3. Terminal blocks connected to CT circuits shall be supplied with means for short-circuit them when necessary.
- 9.3.4. CTs for protection, measurement and control shall be installed inside Neutral Terminal Box of generator.
- 9.3.5. VTs for protection, measurement and control shall be installed inside Power Terminal Box of Generator.
- 9.3.6. Manufacturer shall provide two identical sets of three bus-type CT's for differential protection. One set shall be installed in generator neutral side and the other set shall be delivered to PETROBRAS to be installed in Auxiliary Switchgear.

10. SYNCHRONIZATION CRITERIA

10.1. GENERAL REQUIREMENTS

- 10.1.1. AGCP shall provide all necessary devices and interfaces to control the Auxiliary Generator in order to synchronize it and establish continuous parallel operation with Main Generation, with Emergency Generation and with additional Generic Generation.
- 10.1.2. AGCP shall have a selector switch to select the circuit-breaker to be closed in synchronization process and simultaneously select the adequate necessary voltage (and frequency) reference signals. AGCP shall be capable to establish parallel operation through closing of the following circuit-breakers in Auxiliary Switchgear (see PROJECT ONE-LINE DIAGRAM):
- Auxiliary Generator incoming circuit-breaker;
 - Tie circuit-breaker in Auxiliary Switchgear;
 - Incoming circuit-breaker(s) in Auxiliary Switchgear related to power transformer(s) connected to Main Generation or Hull Generation;
 - Back-feed circuit-breakers in Auxiliary Switchgear.

- 10.1.3. It shall be possible to control the synchronization conditions in AGCP manually through control switches to increase and decrease the voltage and frequency of Auxiliary Generator and through manual closing push-button for the selected circuit-breaker.
- 10.1.4. It shall be possible to control the synchronization conditions in AGCP automatically, through AGC internal control of voltage and frequency of Auxiliary Generator and automatically closing of the selected circuit-breaker.
- 10.1.5. The manual and automatic closing command of the selected circuit-breaker shall be inhibited by synchronization check relay, when necessary conditions are not fulfilled.
- 10.1.6. Remote control of synchronization process of Auxiliary Generator is not required.
- 10.1.7. AGCP shall be capable to automatically perform the following functions:
- a) Synchronism and closing the selected circuit-breaker;
 - b) Transference of loads to the Main (or Generic Generation, or Emergency) Generation system, performing the following steps:
 - b1) Synchronization and parallelism of the Auxiliary Generator with the Main (or Generic, or Emergency) Generation system through a selected circuit-breakers;
 - b2) Load transfer from the Auxiliary Generator to the Main (or Generic, or Emergency) Generation system;
 - b3) Opening of the Auxiliary Generator circuit-breaker after load transference, if wanted.
- 10.1.8. The automatic parallel operation with load transference shall last only the necessary time to transfer the loads from Auxiliary Generator to the Main (or Generic or Emergency) Generation System. Continuous parallel operation with Main Generation and/or Hull Generation shall be possible. Continuous parallel operation with Emergency Generator shall be possible only if approved by Classification Society.
- 10.1.9. For parallel operation of Auxiliary Generator with Emergency Generator, both generators shall commute automatically to Droop mode (regardless of selector switch position) after closing of synchronization circuit-breaker.
- 10.1.10. For parallel operation of Auxiliary Generator with Main Generation, Auxiliary Generator shall commute to Droop mode automatically (regardless of selector switch position) after closing of synchronization circuit-breaker.
- 10.1.11. For parallel operation of Auxiliary Generator with Generic Generation, Auxiliary Generator shall commute to Droop mode automatically (regardless of selector switch position) after closing of synchronization circuit-breaker.
- 10.1.12. The operator shall have the option to commute the Auxiliary Generator to Base Load mode in parallel operations at any time. Base load set point shall be defined by operator.
- 10.1.13. The synchronism board located at AGCP, to permit manual parallelism between Auxiliary Generation and Main (or Generic, or Emergency) Generation System, shall be provided with at least the following facilities:
- a) Double voltmeter;
 - b) Double frequency meter;

- c) Synchronoscope;
- d) Indicative lamp of permission for circuit-breaker closing, by relay (25);
- e) Circuit-breaker's selector switch for parallelism;
- f) Closing push-button for the selected circuit-breaker;
- g) Frequency control switch;
- h) Voltage control switch;
- i) Manual/Automatic Synchronization selector switch;
- j) Starting automatic synchronization process push-button;
- k) Synchronizing relays (function 25) independent for automatic and manual synchronization.

11. INSPECTION AND TESTING

11.1. GENERAL REQUIREMENTS

- 11.1.1. Unless otherwise specified in data-sheets, at least the tests listed in Table 3, Table 4, Table 5 and Table 6 shall be carried out. Engine tests shall be complemented. Tests required by Classification Society, if not listed, are mandatory and shall be included.
- 11.1.2. PACKAGER shall submit the inspection and testing plan (ITP), complying with the requirements of this specification and in data-sheets, to PETROBRAS approval. ITP shall include, at least:
 - a) Routine, type and special tests that will be carried out during manufacturing process (TDPF);
 - b) Routine, type and special tests to be carried out in factory (TAF);
 - c) Field acceptance tests (TAC).

Note: ITP shall indicate for each test, the applicable standards and the acceptance criteria for each measurement and test to be carried.
- 11.1.3. Certificate reports, approved by Classification Society shall be accepted by PETROBRAS for type tests of identical equipment. Certificates presented shall be with valid dates.
- 11.1.4. PACKAGER shall inform consumption of lubrication oil, cooling water and diesel for the tests.
- 11.1.5. Tests shall be witnessed by PETROBRAS surveyors or people appointed by the latter.
- 11.1.6. PACKAGER shall provide for PETROBRAS all results reports of inspections and tests.
- 11.1.7. Unless otherwise defined in data-sheet or in Project documentation, the tolerances defined by standards shall be applicable.
- 11.1.8. In the tests tables, "Project documents" refers to any specific documentation related to Package issued in the Project.

	TECHNICAL SPECIFICATION	No. I-ET-3010.00-5262-700-P4X-001	REV. H
	AREA:	SHEET: 37 of 54	
	TITLE: AUXILIARY GENERATOR PACKAGE FOR OFFSHORE UNITS	INTERNAL	
ESUP			

11.2. LIST OF MINIMUM TESTS

Table 3 – Minimum Tests During Manufacturing Process (TDPF)

(TDPF) Test List Description	RT	TT	ST	Procedure and Acceptance Criteria
Verification of the technical documentation	X			Project documents
Visual inspection	X			Project documents
Verification of the calibration certificates of the instruments used in the tests	X			ITP
Balancing	X			IEC 60034-14
Generator field windings polarity test	X			IEEE 115
Generator short-circuit check on the field winding coils	X			IEEE 115

Table 4 – Minimum Factory Acceptance Tests (TAF)

(TAF) Test List Description	RT	TT	ST	Procedure and Acceptance Criteria
Verification of the technical documentation	X			Project documents
Verification of the calibration certificates of the instruments used in the tests	X			ITP
Verification of the certificates of conformity of the sensors and instruments installed in the generator set	X			Project documents
Visual, dimensional inspection and verification of identification, data and safety plates	X			IEC 60034-1 and Project documents
Accessories check (e.g. heating resistance, CTs, VTs, RTDs, sensors, bearing grounding bush, etc.)	X			Project documents
Measurement of generator winding resistance (cold condition)	X			IEC 60034-1
Air gap and eccentricity measurement of generator	X			API 546, data-sheet and this specification
Checking and marking the direction of rotation of generator	X			Driver documents and data-sheet
Phase sequence verification and terminals marking of generator	X			IEC 60034-1, IEC 60034-8 and ISO 8528
Unbalanced phase check of generator	X			IEC 60034-22
Measurement and analysis of wave form and THD of generator (harmonic signature) at no-load and full load	X			IEC 60034-1, or IEC 61000-4-7

	TECHNICAL SPECIFICATION		No. I-ET-3010.00-5262-700-P4X-001	REV. H
	AREA:			SHEET: 38 of 54
	TITLE: AUXILIARY GENERATOR PACKAGE FOR OFFSHORE UNITS			INTERNAL ESUP
(TAF) Test List Description	RT	TT	ST	Procedure and Acceptance Criteria
Test and determination of the sustained short-circuit curve of generator (short-circuit characteristic)	X			IEC 60034-4-1 and CS
Test and determination of the no-load saturation curve of generator (open-circuit voltage characteristic)	X			IEC 60034-4-1
Generator efficiency measurement	X			IEC 60034-2-1
Checking the location of the magnetic centre of generator ⁽⁴⁾	X			API 546
Generator winding temperature rise		X		IEC 60034-1 and IEC 61892-3, or IEEE 115 Method 4 ⁽¹⁾
Cooling system check	X			This specification
Generator bearings inspection ⁽⁴⁾	X			API 546
Measurement of generator bearings insulation	X			API 546
Bearings temperature rise	X			IEC 60034-1
Generator vibration tests (run out ⁽⁴⁾ , vibration on the shaft, vibration on bearings and operation of the lubrication system)	X			IEC 60034-14
Generator overspeed test (20% in excess of rated rpm, for 2min)	X			IEC 60034-1
Voltage and current on shaft of generator	X			IEEE 115
Measurement of audible noise level of complete set	X			IEC 60034-9 and This specification
Withstand voltage test of generator	X			IEC 60034-1 ⁽²⁾
Measurement of insulation resistance of generator	X			IEEE 43
Measurement of polarization index of generator	X			IEEE 43
Generator occasional overcurrent test		X		IEC 60034-1 and items 7.1.12 and 7.1.13 of this specification.
Sudden three-phase short-circuit (parameter calculation) of generator		X		IEC 60034-4-1
Verification of generator protection degree (IP)		X		IEC 60034-5
Check of lubrication oil ingress inside the generator	X			Visual inspection
Measurement of generator excitation current at rated voltage, current and power factor	X			IEC 60034-4-1 and this specification

	TECHNICAL SPECIFICATION		No. I-ET-3010.00-5262-700-P4X-001	REV. H
	AREA:			SHEET: 39 of 54
	TITLE: AUXILIARY GENERATOR PACKAGE FOR OFFSHORE UNITS			INTERNAL
				ESUP
(TAF) Test List Description	RT	TT	ST	Procedure and Acceptance Criteria
Painting verification (colour, grip and thickness)	X			I-ET-3010.00-5140-741-P4X-004 - SPECIFICATION FOR LOW-VOLTAGE GENERIC ELECTRICAL PANELS FOR OFFSHORE UNITS [35] I-ET-3010.00-5140-714-P4X-001 - SPECIFICATION FOR ELECTRICAL BATTERIES FOR OFFSHORE UNITS [36] I-ET-3010.00-5140-773-P4X-002 - SPECIFICATION FOR GENERIC D.C. UPS FOR OFFSHORE UNITS I-ET-3010.00-1200-956-P4X-002 - GENERAL PAINTING
Functional and performance test of excitation system, including AVR	X			This specification
Notes 1) In case of use of IEEE 115 Method 4, consider all criteria for open-circuit and short-circuit loading: a) specified voltage with terminals open; b) specified armature current with the terminals short-circuited; c) zero excitation. 2) Withstand voltage test shall be carried out immediately after temperature rise. 3) The quantities corresponding to the saturated state of the machine shall be obtained from a test performed at rated armature voltage. If, due to limitation of testing facilities, it is not possible to attain rated armature voltage, sudden-short circuit tests shall be performed at three voltage levels, and the quantities determined for each test. The values thus obtained are then represented against their corresponding open-circuit voltage before short-circuiting and the approximate rated armature voltage quantity is found by extrapolation. 4) Applicable only to machines with sleeve bearings.				

	TECHNICAL SPECIFICATION	No. I-ET-3010.00-5262-700-P4X-001	REV. H
	AREA:	SHEET: 40 of 54	
	TITLE: AUXILIARY GENERATOR PACKAGE FOR OFFSHORE UNITS	INTERNAL	
ESUP			

Table 5 – Minimum String Tests

String Test Description	Procedure and Acceptance Criteria
Checking of technical documentation	Project documents
Verification of the calibration certificates of the instruments used in the tests	ITP
Measurement of insulation resistance and polarization index	IEEE 43
Measuring of voltage regulation during steady state and transient loading and unloading ⁽¹⁾	IEC 61892-3 and limits by 8.4.14 and 8.4.16 of this specification
Measuring of frequency regulation during steady state and transient loading and unloading ⁽¹⁾	ISO 8528-5 and limits by 8.4.15 and 8.4.16 of this specification
Measurement of voltage at engine bearings	Manufacturer limits
Visual inspection and verification of assembly and identification, data and safety plates	Project documents
Vibration tests (run out ⁽²⁾ , vibration on the shaft ⁽²⁾ , vibration on bearings and operation of the lubrication system)	Project documents
Continuous operation tests (including full load temperature rise)	Project documents
Functional test of alarms, measuring devices, control, signalling, keys and relays for the control panels.	Project documents
Checking the protection functions	Project documents
Short-Circuit Withstand Test	IEC 60034-1
User and access (local) profile check	Project Documents

Notes: 1) Transient voltage and frequency regulation limits shall be complied for the following steps:

- 0% → 25%;
- 25% → 50%
- 50% → 75%
- 75% → 100%
- 100% → 0%
- 75% → 0%
- 50% → 0%
- 25% → 0%
- 40% → 90%

2) Applicable only to machines with sleeve bearings.

Table 6 - Minimum Field Acceptance Tests (TAC)

(TAC) Description	Method and Acceptance Criteria
Checking of technical documentation	Project documents
Verification of the calibration certificates of the instruments used in the tests	ITP

	TECHNICAL SPECIFICATION	No. I-ET-3010.00-5262-700-P4X-001	REV. H
	AREA:	SHEET: 41 of 54	
	TITLE: AUXILIARY GENERATOR PACKAGE FOR OFFSHORE UNITS	INTERNAL ESUP	
(TAC) Description		Method and Acceptance Criteria	
Visual inspection and verification of assembly and identification, data and safety plates		Project documents	
Measurement of insulation resistance		IEEE Std 43	
Complete functional tests and control of equipment parameters on control panels		Project documents	
Measurement of start-up time for load equal to 50%, 75%, 100% and 110% of engine braking power		45s	
Measurement of power and speed for load equal to 50%, 75%, 100% and 110% of engine braking power		Project documents	
Measurement of consumption of lube oil, coolant water and fuel oil		Project documents	
Measurement of mechanical oscillation (vibration)		Project documents	
Measurement of noise level		Project documents	
Test of minimum number of starts		Project documents	
Crankshaft deflection measurement at cold and hot condition		Project documents	
Engine/Generator set overspeed protection test		IEC 60034-1	
Vibration tests (vibration on bearings and operation of lubrication system)		Project documents	
Parallel operation and load transference, voltage and frequency response for the biggest motor start up		Project documents	
Tests on alarms, protection, metering devices, controls, signalling, switches and relays, including spare parts		Project documents	
Continuous full rated load operation test (minimum 2h after temperature stabilization)		No failure or parameter out of range	
Synchronizing test		Project documents	
Check of protection functions		Project documents	
Check of lubrication oil ingress inside generator frame ⁽¹⁾		No ingress	
Measurement and analysis of wave form and THD of generator (harmonic signature) for load equal to 50%, 75%, 100% and 110% of engine braking power		IEC 60034-1, or IEC 61000-4-7	
User and access (local and remote) profile check		This specification	
Check of remote configuration and supervision software operability		This specification	
Check of time synchronization with Time Server		This specification	
Test of external ESD actuation, stopping Package		This specification	
Test of fail-safe condition (generator operation blocked) of external ESD		This specification	
Test of fail-safe condition of control voltage failure in Auxiliary Switchgear (generator operation allowed, starting process allowed, Auxiliary Generator circuit-breaker closure command blocked)		This specification	
Undervoltage at Auxiliary Switchgear test (generator start-up, Auxiliary Generator circuit-breaker kept open)		This specification	
Measuring of voltage regulation during steady and transient loading and unloading		8.4.14 and 8.4.15 of this specification	

	TECHNICAL SPECIFICATION	No. I-ET-3010.00-5262-700-P4X-001	REV. H
	AREA:	SHEET: 42 of 54	
	TITLE: AUXILIARY GENERATOR PACKAGE FOR OFFSHORE UNITS	INTERNAL	
		ESUP	
(TAC) Description		Method and Acceptance Criteria	
Measuring of frequency regulation during steady and transient loading and unloading		7.1.15 and 8.4.15 of this specification	
Note	1) Including check of proper installation of siphon in lube oil piping before generator bearing inlet points.		
<h2>12. TECHNICAL DOCUMENTATION</h2>			
12.1.	Data filled in data-sheet issued by PETROBRAS are mandatory. In case of divergence between the data-sheet issued by PETROBRAS and this specification, data-sheet data prevails.		
12.2.	If there is no generator data-sheet issued by PETROBRAS, the template of I-LI-3010.00-5140-700-P4X-001 - ELECTRICAL EQUIPMENT DATA-SHEET MODELS shall be used.		
12.3.	MANUFACTURER shall list, in the data-sheet, the technical standards applied to the manufacturing and testing of the equipment, which complement the ones presented in section 3.1.		
12.4.	The data-sheet fields, filled by the Manufacturer for BID may consider tolerances according to project requirements. As built data-sheet shall be filled in with final measured and tested data.		
12.5.	Manufacturer shall provide all certification required by Classification Society.		
12.6.	It shall be issued Brazilian Portuguese versions for all documents required by NR-12, besides the English version, including at least operation manual, maintenance manual and safety documents.		
12.7.	Documentation shall be send to PETROBRAS for approval.		
12.8.	A group of documents shall be supplied containing at least the following data:		
	a) Documents list;		
	b) List of standards applicable to the design, fabrication and tests;		
	c) Country of origin of the equipment;		
	d) List of similar previous supplies consistent with the specification requirements defined by PETROBRAS;		
	e) List of deviations from project documentation;		
	f) Utility consumption list;		
	g) List of all equipment, components, materials, parts, pieces, accessories and devices, with identification of manufacturer, part number and model;		
	h) Description service capabilities, price schedule and service support during testing, installation, commissioning, and maintenance;		
	i) Data sheets of all equipment duly filled out with technical data and all tests to be applied. Electrical auxiliary equipment and components shall have data-sheet issued, according to templates of I-LI-3010.00-5140-700-P4X-001 - ELECTRICAL EQUIPMENT DATA-SHEET MODELS;		

- j) Drawings of all equipment, showing lay-out of components, main dimensions, static and dynamic weights, center of gravity and minimum space for maintenance;
- k) Specification or description of generator set protections, including settings;
- l) Specification or description and diagrams of generator set lubrication system;
- m) Specification of excitation system, with modules architecture, protection, communication e performance data;
- n) Specification of painting system for generator and all accessories;
- o) Technical catalogues of all generator components containing all information and technical characteristics;
- p) List of sensors and instruments, with respective data;
- q) Lifting drawings;
- r) Drawings showing electrical, instruments and utilities end connections;
- s) Drawings showing details of attachments and couplings;
- t) Drawing showing the rotation direction;
- u) One-line, multi-line, functional, logical and block diagrams for generator, excitation system, control panels and auxiliary components;
- v) Power, control and instruments wiring and interconnection diagrams;
- w) Complete source codes of all software related to controllers and electronic devices, including tables with parameters adjustments;
- x) Mathematical models as indicated below:
- A detailed block diagram of the voltage regulator, including limiting actions and exciter blocks, to be used in dynamic performance studies of the system. Ranges for the settings and final setting of the voltage regulator shall be informed.
 - A detailed block diagram for diesel generator, diesel engine and its speed regulator, to be used in dynamic performance studies (load shedding and load rejection-generation dropping studies). Ranges for the settings and final setting of the speed regulator shall be informed.
 - A description of the coordinated combustion-speed regulation shall be furnished.
 - Generator's mathematical models, including all parameters.
- y) Generator characteristics curves:
- Capability curves for at least 80% of rated ambient temperature, 100% of rated ambient temperature and 120% of rated ambient temperature;
 - Capability curves for at least 95% of rated voltage, 100% of rated voltage and 105% of rated voltage;
 - Stator thermal limits (stator current x time);
 - Rotor thermal limits (field current x time);
 - Magnetic package damage curve due to ground fault (current through stator core lamination x time);

**TECHNICAL SPECIFICATION**

No. I-ET-3010.00-5262-700-P4X-001

REV. H

AREA:

SHEET: 44 of 54

TITLE:

**AUXILIARY GENERATOR PACKAGE FOR OFFSHORE
UNITS**

INTERNAL

ESUP

- Efficiency curves (efficiency x power) for at least power factors of 0.8, 0.85, 0.9 and 1.0;
 - Short-circuit characteristic curve (Stator current x Field current), for at least 95% of rated voltage, rated voltage and 105% of rated voltage;
 - Saturation curve (stator voltage x field current), for at least no load, rated load and zero power factor), at least 95% of rated voltage, rated voltage and 105% of rated voltage;
 - No load characteristic curve;
 - Exciter saturation curve (main rotor voltage x field current);
 - Efficiency curve (efficiency x ambient temperature);
 - Negative sequence curve (I_2 x time);
 - Overflux limit curve (V/Hz x time);
 - V curves at no load and at 25%, 50%, 75% and 100% of the machine rated load;
 - V curves for at least 95% of rated voltage, rated voltage and 105% of rated voltage;
 - Stator current decrement curves – field response (stator current x field current), including symmetrical three-phase short-circuit, DC component of three-phase short-circuit and field current;
 - Stator current decrement curves – field response (stator current x field current), including symmetrical three-phase short-circuit, DC component of three-phase short-circuit and constant field current;
 - Stator current decrement curves – field response (stator current x field current), including symmetrical line-line short-circuit, DC component of line-line short-circuit and field current;
 - Stator current decrement curves – field response (stator current x field current), including symmetrical line-line short-circuit, DC component of line-line short-circuit and constant field current;
 - Stator current decrement curves – field response (stator current x field current), including symmetrical line-ground short-circuit, DC component of line-ground short-circuit and field current;
 - Stator current decrement curves – field response (stator current x field current), including symmetrical line-ground short-circuit, DC component of line-ground short-circuit and constant field current;
 - Voltage and frequency variations as a function of time for sudden application of 30 %, 50 %, 80 % and 100 % of the generator's rated load;
 - Voltage and frequency variation limits curve, showing allowable zones;
 - Output power curve (output power x cooling water temperature), for at least temperature rise class B and temperature rise class F.
- z) Base forces and stress data;
- aa) Location of grounding terminal(s);

- bb) Detailed drawings of Power Terminal Box, Neutral Connection Box, as well as details of installation and location of auxiliary boxes for control terminals;
- cc) Lay-out of all holes for inlet of cables and/or conduit for all connecting boxes and panels, giving diameters of holes and characteristics of corresponding cables;
- dd) Saturation curves for current transformers;
- ee) Curves showing voltage and frequency variations in terms of time, for sudden application of 30%, 50%, 80% and 100% of the generator rated load;
- ff) Calculation reports of adjustments of protection relays;
- gg) Calculation reports of voltage drop on start of biggest motor;
- hh) Final "as built" characteristics of generator group;
- ii) Inspection and Tests Plan (ITP);
- jj) Classification Society Test Report;
- kk) Submission Noise Data presented in Forms I and II (Annex I).
- ll) Starting air system calculation reports, with at least:
 - Power required by compressor unit;
 - Rack (x) pinion reduction factor;
 - Rotation of starting motor;
 - Manufacturers/model of starting motor;
 - Working pressure of starting motor;
 - Consumption of compressed air, including three automatic starting cycles attempts;
 - Air vessel capacity;
 - Initial and final pressure in air vessel, considering three automatic starting cycles;
 - Volume of air required at specified pressure;
 - Requirements complying with NR-13.
- mm) Spare part list recommended for 2 (two) years of operation shall be provided with the proposal, including prices.
- nn) List of spare parts for commissioning and tests;
- oo) List of unusual tools required for maintenance of the generator set;
- pp) Calculation report of the diesel fuel consumption by engine at rated load;
- qq) Calculation report of the diesel oil tank volume, indicating:
 - tank volume required;
 - period of operation without replenishment (at least 18h).
- rr) Minimum height required for installing diesel tank so that oil may flow by gravity to the pump;
- ss) Diesel engine voltage and edge currents limits;

tt) Certificates of all equipment for hazardous areas, if any.

12.9. It shall be furnished Operation Manuals for the control panel and devices included in generation package (AGC, AVR, Speed Governor, etc.). These documents shall be presented in English and Brazilian Portuguese. The manual contents shall include a minimum of:

- a) Operation procedures;
- b) Complete detailed functional, control and protection diagrams;
- c) Detailed logical diagrams, showing functional sequence of the control circuits for each one the operational conditions;
- d) Panels interconnections diagrams;
- e) Troubleshooting, repair and maintenance (predictive, preventive and corrective) procedures;
- f) Assembly, disassembly and installation procedures;
- g) Attachment and coupling procedure manuals;
- h) Lifting procedures;
- i) Packing, storage and transportation procedures;
- j) Software and configurations procedures for controllers and electronic devices.
- k) List of components, including item, description, draw, unit, quantity and part number;
- l) Reports of all test and trials;
- m) List of standards considered for design, construction and test;
- n) Detailed description of the equipment, including all accessories;
- o) List of risks to personnel and environment related to the equipment, including pollutant emissions at rated capacity;
- p) List of risks related to changing or override of protections and safety devices;
- q) List of risks related to use of equipment out of design conditions;
- r) Procedures during emergency conditions;
- s) List of safety equipment and components, including expected life-time for each item.

13. ADDITIONAL REQUIREMENTS FOR GENERIC GENERATOR PACKAGES

13.1. APPLICATION

13.1.1. These additional requirements are applicable to low-voltage generic generators not directly connected to Essential or Auxiliary Switchgears and driven by diesel engine.

13.1.2. For Generic Generator Packages, unless otherwise defined, all requirements of this specification apply added of the following complementary requirements.

13.2. ADDITIONAL SCOPE OF SUPPLY

- 13.2.1. At least the following systems and items shall be provided by PACKAGER additionally to scope defined in item 5.2 (except for the item 5.2.2. a) Start-up air compressor unit, start-up air vessel and air piping;):
- a) Enclosure (container);
 - b) HVAC system;
 - c) Fire&Gas system;
 - d) 18 Hour Fuel Dedicated Tank, minimum;
 - e) Firefighting system;
 - f) Handling equipment;
 - g) Exhaust duct and support structure;
 - h) 3D model (step file);
 - i) Generic Generator local power and control panel for control, protection, metering, synchronization, power distribution and auxiliary equipment control (GGCP).
- 13.2.2. The Generic Generator Package shall be furnished complete with all components including instrumentations and control system for the intended operation in accordance with project requirements.
- 13.2.3. Unless specified, the PACKAGE scope of supply is per generator package based. Common use of auxiliaries for multiple generator packages are not approved.

13.3. GENERAL

- 13.3.1. Generator, auxiliary systems and all generic generator package equipment (generator power and control panel, diesel engine, pumps, etc.) identification (tag, name, description, etc.) shall be in accordance with Project Documentation.
- 13.3.2. Generator starting procedure shall be in accordance with Project Documentation.
- 13.3.3. Unless otherwise specified in the datasheet, the generator shall have minimum IP56W protection degree, including exciter, terminal boxes and accessories, when installed in an external environment of floating UNITS, according to IEC 60034-5. The suffix W is only applicable for terminal boxes.
- 13.3.4. Generic Generator reactances shall be defined in order to keep the short-circuit current in panel where its incoming circuit-breaker is connected within the limits defined by I-ET-3010.00-5140-700-P4X-001 - SPECIFICATION FOR ELECTRICAL DESIGN FOR OFFSHORE UNITS when:
- a) Generic Generator is in parallel operation with Main Generation
 - b) Generic Generator is in parallel operation with Auxiliary Generation.
 - c) Generic Generator is in parallel operation with Emergency Generation.

13.4. MECHANICAL AND PIPING

- 13.4.1. All interconnecting piping shall comply with the requirements of ASME B31.3.

**TECHNICAL SPECIFICATION**

No. I-ET-3010.00-5262-700-P4X-001

REV. H

AREA:

SHEET: 48 of 54

TITLE:

**AUXILIARY GENERATOR PACKAGE FOR OFFSHORE
UNITS**

INTERNAL

ESUP

- 13.4.2. All skid piping within the limits of supply shall be fabricated and terminated at the baseplate edge by means of valves and/or flanges and blind flanges according to ASME B16.5.
- 13.4.3. Maximum allowable pressure drop for pressure relief devices shall comply with API requirements.
- 13.4.4. Piping supports, instrument tappings, design pressures etc. shall be suitable for sustained operation under the pressure pulsations that occur if the bladders of pulsation dampeners fail.
- 13.4.5. Double block & bleed arrangements are required for isolation of equipment in piping classes of 300# and above.
- 13.4.6. All tie-ins shall be flanged and provided with valves to isolate the system.
- 13.4.7. Socket welding is only permitted on low-pressure (non-process) piping sizes equal or less than 1½ inch. All piping above 1 ½ inch shall be butt-welded.
- 13.4.8. The level gauges shall be installed in such position that the level indicated in receiver will be easily seen. All level gauges shall have flanged connections, which can be isolated, and be complete with vent and drain, valves and connection.
- 13.4.9. All valves shall be positioned with the stem pointing upwards. They shall be located in such a way that the handwheel or actuator will not obstruct walkways and be easily accessible for operation and maintenance. Where hand operated valves are not easily operable, gear operated valves shall be used.
- 13.4.10. Valves, instruments, etc. elevated above 1.75 m above the floor, shall have access ladders or platform provided.
- 13.4.11. Sampling point/facilities shall be provided complete with necessary fittings and valves, and the design shall reflect nature of the fluids being sampled.
- 13.4.12. Heat exchanger piping shall not be supported on the body of the exchanger (shell or plate frame) and shall not hamper the maintenance operations (removal of the tube bundle and shell /channel cover or of the plate bundle, if applicable). A removable pipe spool may be required.
- 13.4.13. Piping shall be routed to allow access for maintenance. Removal of replacement of equipment shall be possible with a minimum dismantling of piping.
- 13.4.14. Piping at pumps shall be sufficiently flexible and adequately supported to prevent the equipment nozzle from being subjected to any stress that could disturb the alignment and internal clearance.
- 13.4.15. Pump suction piping shall be arranged such that the flow is as smooth and uniform as possible. To achieve this end, a straight run shall be considered before suction nozzle, as per API RP 686.
- 13.4.16. Piping systems shall not extend the operating floor.
- 13.4.17. All other miscellaneous items and equipment which are required for the service and proper operation of the Generic Generator Package shall be included.
- 13.4.18. Studs, bolts, tightening bolts and nuts shall be according I-ET-3010.00-1200-251-P4X-001 - REQUIREMENTS FOR BOLTING MATERIALS.

**TECHNICAL SPECIFICATION**

No. I-ET-3010.00-5262-700-P4X-001

REV. H

AREA:

SHEET: 49 of 54

TITLE:

**AUXILIARY GENERATOR PACKAGE FOR OFFSHORE
UNITS**

INTERNAL

ESUP

13.4.19. All vessel internals (Packing, weirs, baffles, skimming device, etc) shall be fabricated in CRA (Certificate of Receipt of Application) and shall be compatible with fluid characteristics. The minimum requirement for CRA is SS316.

13.4.20. All pressure vessels and items shall be designed in accordance with I-ET-3010.00-1200-540-P4X-001 - REQUIREMENTS FOR PRESSURE VESSELS DESIGN and Brazilian National Regulation NR-13.

13.4.21. All equipment shall be provided with lifting lugs.

13.4.22. All welding shall meet the requirements of I-ET-3010.00-1200-955-P4X-001 - WELDING.

13.5. PACKAGE LOCATION AND AREA CLASSIFICATION

13.5.1. The Generic Generator Package shall be installed according to project documentation. The package dimensions shall be restricted to the available space in document PROJECT MODULE LAYOUT PLAN.

13.5.2. All equipment installed in hazardous area shall be certified according to area classification. Refer to PROJECT AREA CLASSIFICATION.

13.6. HVAC SYSTEM

13.6.1. HVAC Package System shall comply with HVAC PROJECT DOCUMENTATION and Classification Society rules.

13.6.2. Gas detectors, in a 2oo3 voting logic, shall be installed at all enclosure air intakes and connected a separate PLC for interlocking/F&G purposes in GGCP. In case of confirmed gas in generic generator enclosure emergency air intake (emergency air intake is different from normal air intake) or confirmed fire inside the enclosure, the following actions shall be performed:

- GGCP shall send a signal to F&G in order to indicate confirmed fire inside the enclosure.
- GGCP shall inhibit the starting process of the generator when it is stopped. If the generator is running, this signal shall inhibit the starting process of the generator and shall stop the generator set. A pilot lamp shall be provided at GGCP indicating the status of this signal.
- HVAC system to close the ventilation damper (emergency air intake and emergency air discharge) of the enclosure.

13.6.3. PACKAGER shall supply a complete HVAC system for the enclosure, include inlet/outlet filter and dampers, ducts and controls. At least two separate systems shall be provided as follows:

13.8.3.1. System for normal operation (engine in stand by)

- This system shall supply air to the enclosure at a minimum of 6 (six) air changes per hour and shall maintain the minimum positive pressure as required by Classification Society.
- Exhaust may be louvered pressure-relief outlets to atmosphere. Rates of ventilation shall take in account the residual heat dissipation immediately following the engine shutdown.

**TECHNICAL SPECIFICATION**

No. I-ET-3010.00-5262-700-P4X-001

REV. H

AREA:

SHEET: 50 of 54

TITLE:

**AUXILIARY GENERATOR PACKAGE FOR OFFSHORE
UNITS**

INTERNAL

ESUP

- Fire/gas damper logic shall be fully executed in GGCP, on a separate PLC for interlocking/F&G purposes.

13.8.3.2. System for generator operation (engine running)

- This system shall provide the cooling air and the required combustion air, and is to be powered from the generator set (independent from other platform electrical generation). Fire/gas dampers in this case shall be interlocked with engine operation.
- An air cooling unit may be included to keep the temperature inside the enclosure at an acceptable level for safe operation of the unit.
- An inlet for dedicated combustion air to the engine shall be provided.

13.6.4. Combustion air ducting shall be routed to the container roof or sidewall (observing interferences with adjacent modules) and fitted with low velocity two-stage coalescent filter and fire damper with shut-off device.

13.7. SAFETY REQUIREMENTS

13.9.1. Fire and gas detection system and fire suppression systems shall be provided, in accordance with DR-ENGP-M-I-1.3 - SAFETY ENGINEERING and Project Documentation.

13.9.2. For further details for signals interfaces with FPSO Automation refer to I-ET-3010.00-1200-800-P4X-002 - AUTOMATION, CONTROL AND INSTRUMENTATION ON PACKAGE UNITS and AUTOMATION INTERFACE OF PACKAGE UNITS SPECIFICATION.

13.8. MATERIALS

13.10.1. The PACKAGER is responsible for the materials specifications in accordance with process fluid and operational conditions.

13.10.2. All materials that are exposed to hydrocarbons containing hydrogen sulphide must follow the requirements of ISO 15156 for sour service.

13.10.3. When using austenitic SS, only materials that are not susceptible to sensitization shall be used (low C steels, types L and ELC or stabilized steels).

13.10.4. The corrosion allowance shall be defined during detailing by the PACKAGER, but shall be not less than 1.6mm.

13.10.5. The repair and defects in pressure-containing castings by peening or burning-in or by impregnation with other compounds is not allowed.

13.10.6. Repair by welding or by plugging shall be undertaken only when permitted by the material specification and shall only be applied with the procedures specified.

13.10.7. After weld repair, castings shall be heat treated, if specified in the material specification. A major weld repair shall always be followed by a suitable heat treatment.

13.10.8. Details of all major weld repairs and heat treatment shall be recorded and reported to PETROBRAS.

13.10.9. The use of asbestos or materials containing asbestos is prohibited.

**TECHNICAL SPECIFICATION**

No. I-ET-3010.00-5262-700-P4X-001

REV. H

AREA:

SHEET: 51 of 54

TITLE:

**AUXILIARY GENERATOR PACKAGE FOR OFFSHORE
UNITS**

INTERNAL

ESUP

13.10.10. In order to ensure that the materials of construction are in accordance with project documentation, all certificates shall contain the following information:

- Name of MANUFACTURER
- Purchase order number and issue date
- Identification number of certificate and issue date
- Material specification(s)
- Material charge, batch or heat number
- Mechanical properties recorded from test results
- Non-Destructive Examination method and results
- Heat treatment procedure

13.9. ENCLOSURE

13.11.1. Enclosure shall be furnished for entire equipment and accessories. Shall consist of walls, doors, roof and hatches. Material selection shall consider an offshore environment. It shall avoid ingress of water, wind and dust. Thermal and acoustic insulation shall be designed to accomplish HVAC and Acoustic requirements. Doors location, openings and internal layout shall consider handling study, safety studies and regulation.

13.10. AUTOMATION, CONTROL AND INSTRUMENTATION SYSTEM

13.12.1. Automation, control and instrumentation system shall comply with requirements of I-ET-3010.00-1200-800-P4X-013 - GENERAL CRITERIA FOR INSTRUMENTATION PROJECTS, I-ET-3010.00-1200-800-P4X-002 - AUTOMATION, CONTROL AND INSTRUMENTATION ON PACKAGE UNITS and AUTOMATION INTERFACE OF PACKAGE UNITS SPECIFICATION.

13.11. ENCLOSURE ELECTRICAL INSTALLATIONS

13.13.1. Package electrical installations shall comply with I-ET-3010.00-5140-700-P4X-003 - ELECTRICAL REQUIREMENTS FOR PACKAGES FOR OFFSHORE UNITS.

13.13.2. PACKAGER shall foresee space for installation of four (4) lighting panels in bulkhead. Final dimensions of these panels shall be available during Detailed Design.

13.12. PERSONNEL PROTECTION AND THERMAL INSULATION

13.14.1. Equipment and piping subjected to temperature of 60°C and above shall receive a personal protection system, by means of 316SS wire mesh / perforated plates. Alternatively, a thermally insulated system may be applied. Equipment and piping in which heat conservation is necessary shall be thermal insulated. The thermal insulation shall be according of I-ET-3010.00-1200-431-P4X-001 - THERMAL INSULATION FOR MARITIME INSTALLATIONS.

14. ABBREVIATIONS AND ACRONYMS

AGC	Auxiliary Generator Controller
AGCP	Auxiliary Generator Power and Control Panel

	TECHNICAL SPECIFICATION	No. I-ET-3010.00-5262-700-P4X-001	REV. H
	AREA:	SHEET: 52 of 54	
	TITLE: AUXILIARY GENERATOR PACKAGE FOR OFFSHORE UNITS	INTERNAL	
		ESUP	

AO	Analog Output
ASTM	American Society for Testing and Materials
AVR	Automatic Voltage Regulator
CSS	Control & Safety System
CS	Classification Society
CT	Current Transformer
DO	Digital Output
ESA	Electrical System Automation
ESD	Emergency Shutdown
F&G	Fire and Gas System
GGCP	Generic Generator Power and Control Panel
HMI	Human-Machine Interface (current designation for MMI)
IEC	International Electrotechnical Commission
ISO	International Organization for Standardization
PMG	Permanent Magnetic Generator
PLC	Programmable Logic Controllers
VT	Voltage Transformer

15. HOLD POINTS

- 15.1. Requirements for generators to be installed in bolted grounded neutral system.



AREA:

SHEET: 53 of 54

TITLE: **AUXILIARY GENERATOR PACKAGE FOR OFFSHORE UNITS**

INTERNAL

ESUP

16. ANNEX I – SUBMISSION NOISE DATA FORMS

FORM - I

GENERAL

Equipment: _____
 Code: _____
 Supplier: _____
 Proposal n°: _____ Date: _____
 Submit According To Standard: _____
 (If Calculated Values Enclose Worksheets)

OPERATING CONDITIONS (TEST)

Flow m³/h: _____ Pressure (Bar Abs): _____
 Rotation (rpm): _____ Load Condition: _____
 Temperature (°C): _____ Control Valve Position (% Open): _____

NOISE CONTROL DATA

Enclosure _____ Manuf.: _____ Model: _____
 Muffler: _____ Manuf.: _____ Model: _____
 Type: _____ Press. Drop _____ Face Velo _____
 Flexible _____ Manuf.: _____ Model: _____
 Blanket _____

ACOUSTICAL MEASUREMENT DATA

Sound Level Meter: _____ Manuf. _____
 Microphone _____ Manuf. _____ Serial: _____
 Filter Set: _____ Manuf. _____
 Fast _____ Slow _____ Impulse: _____ Leq: _____ Max. _____



TECHNICAL SPECIFICATION

No. I-ET-3010.00-5262-700-P4X-001

REV. H

AREA:

SHEET: 54 of 54

TITLE: **AUXILIARY GENERATOR PACKAGE FOR OFFSHORE UNITS**

INTERNAL

ESUP

FORM - II

SUPPLIER DATA		dBA	Octave band centre frequency							
Guaranteed noise levels (Note 1)			31.5	63	125	250	500	1000	2000	4000
Lw										
Lp (1)										
Lp (2)										
LP (3)										
Lp (4)										
ENCLOSE, I.L.										
ENCLOSURE (enclosure absorption coefficient)										
MUFFLER, D.I.L.										
Expected vibration levels (Note 2)										
Narrow band component, Yes / No Frequency / octave band Hz: _____										
Method / standard for noise level test: _____										
Description of implemented noise control measures / other information: _____										
AS BUILT NOISE DATA		dBA	Octave band centre frequency							
Measured noise level (Note 1)			31.5	63	125	250	500	1000	2000	4000
Lw										
Lp (1)										
Lp (2)										
LP (3)										
Lp (4)										
ENCLOSE, I.L.										
ENCLOSURE (enclosure absorption coefficient)										
MUFFLER, D.I.L.										
Special information: _____										
Note 1	SPL	Sound pressure level in dB (re. 20µPa) at 1m distance free field conditions.								
	SWL	Sound power level in dB (re. 1 pW).								
Note 2	VVL	Vibration velocity level in dB (re. 5x10 ⁻⁴ m/s) RMS on skid adjacent to support points.								