	<b>TECHNICAL SPECIFICATION</b>		Nr: <b>I-ET-3010.2E-1359-940-P4X-001</b>
	CLIENT: <b>SRGE</b>		SHEET: <b>1</b> of <b>34</b>
	JOB: <b>REFERENCE HULL 01</b>		
	AREA: <b>-</b>		
<b>SRGE</b>	<b>OFFLOADING SYSTEM</b>		<b>INTERNAL</b>
			<b>ESUP</b>

File No.: MICROSOFT WORD 2016 – I-ET-3010.2E-1359-940-P4X-001\_A.docx

### INDEX OF REVISIONS

REV.	DESCRIPTION AND/OR REVISED SHEETS
0	ORIGINAL ISSUE
A	REVISED WHERE INDICATED

	REV. 0	REV. A	REV. B	REV. C	REV. D	REV. E	REV. F	REV. G	REV. H
DATE	OUT/04/22	DEC/09/22							
PROJECT	ESUP/ENE	ESUP/ENE							
EXECUTION	CXZ0	CXZ0							
CHECK	CXW3	CXW3							
APPROVAL	UPDM	BYA6							

THE INFORMATION CONTAINED IN THIS DOCUMENT IS PETROBRAS PROPERTY AND MAY NOT BE USED FOR PURPOSES OTHER THAN SPECIFICALLY INDICATED HEREIN.

THIS FORM IS PART OF PETROBRAS N-381 REV.M ANNEX A – FIGURE A.1.



	TECHNICAL SPECIFICATION	Nr: I-ET-3010.2E-1359-940-P4X-001	REV. A
	-		SHEET: 2 of 34
	TITLE: OFFLOADING SYSTEM		INTERNAL

TABLE OF CONTENTS	PAGE
<b>1. INTRODUCTION .....</b>	<b>4</b>
1.1. OBJECTIVE.....	4
1.2. DEFINITIONS .....	4
1.3. ABBREVIATIONS .....	4
<b>2. NORMATIVE REFERENCES .....</b>	<b>5</b>
2.1. INTERNATIONAL CODES, RECOMMENDED PRACTICES AND STANDARDS .....	5
2.2. BRAZILIAN CODES AND STANDARDS.....	6
2.3. CLASS APPROVAL AND CERTIFICATION .....	6
<b>3. REFERENCE DOCUMENTS.....</b>	<b>6</b>
3.1. REFERENCE HULL 01 FPSO BASIC DESIGN .....	6
3.2. TYPICAL DOCUMENTS .....	6
3.3. SPECIFIC PROJECT DOCUMENTS .....	8
<b>4. DESIGN REQUIREMENTS .....</b>	<b>9</b>
4.1. DESIGN CONDITIONS.....	9
4.2. SAFETY REQUIREMENTS .....	9
4.3. NOISE AND VIBRATIONS.....	10
4.4. MOTIONS AND ACCELERATION .....	10
4.5. OFFLOADING OPERATION TOTAL TIME AND FREQUENCY .....	10
4.6. CRUDE OIL DATA.....	10
<b>5. MOORING EQUIPMENT .....</b>	<b>11</b>
5.1. SCOPE OF SUPPLY .....	11
5.2. GENERAL.....	11
5.3. MOORING HAWSER ASSEMBLY.....	12
5.4. MOORING HAWSER CHARACTERISTICS .....	13
5.5. HAWSER REEL (AFT) (GN-Z-1359502-02) AND HAWSER REEL (FWD) (GN-Z-1359506-02) .....	13
<b>6. OFFLOADING EQUIPMENT SPECIFICATION.....</b>	<b>15</b>
6.1. SCOPE OF SUPPLY .....	15
6.2. GENERAL SPECIFICATION.....	17
6.3. HOSE REEL .....	18
6.4. HOSE REEL SPOOLING DEVICE.....	21
6.5. OFFLOADING HYDRAULIC POWER UNITS (UH-1359506A/B) .....	21
6.6. CONTROL CONSOLES.....	22

 <b>PETROBRAS</b>	<b>TECHNICAL SPECIFICATION</b>	Nr: <b>I-ET-3010.2E-1359-940-P4X-001</b>	REV. <b>A</b>
	-		SHEET: 3 of 34
	TITLE: <b>OFFLOADING SYSTEM</b>		INTERNAL
<p>6.7. SPECIAL DEVICES AND MECHANISMS.....23</p> <p>6.8. OFFLOADING HOSE STRING .....23</p> <p>6.9. OUTBOARD HOSE TERMINATION PIECE (NORTH SEA VALVE) .....25</p> <p>6.10. DETACHABLE HOSE BRIDLE .....27</p> <p>6.11. EMERGENCY OFFLOADING STATION/WINCH (GN-Z-1359502-04 / GN-Z-1359506-04) AND EMERGENCY OFFLOADING STRING.....28</p> <p>6.12. AUXILIARY WINCH FOR HOSE MESSENGER / HAWSER MESSENGER (GN-Z-1359502-03 / Z-1359506-03) .....28</p> <p><b>7. GENERAL REQUIREMENTS.....29</b></p> <p>7.1. ELECTRICAL REQUIREMENTS .....29</p> <p>7.2. INSTRUMENTATION AND AUTOMATION REQUIREMENTS .....30</p> <p>7.3. PAINTING REQUIREMENTS .....30</p> <p>7.4. NAMEPLATES AND TAG NUMBERING.....30</p> <p><b>8. PACKAGE MANUFACTURING AND DELIVERY REQUIREMENTS.....30</b></p> <p>8.1. GENERAL.....30</p> <p>8.2. WELDING .....31</p> <p>8.3. DOCUMENTATION .....31</p> <p>8.4. SPARE PARTS.....32</p> <p>8.5. PRESERVATION, PACKING AND TRANSPORTATION.....32</p> <p><b>9. INSPECTION AND TESTS.....32</b></p> <p>9.2. PRESSURE TEST OF HOSES AND PIPING ON REEL .....32</p> <p><b>10. ANNEX I – OFFLOADING OPERATIONAL DATA AND REQUIREMENTS .....33</b></p> <p>10.1. OFFLOADING OPERATIONAL SECTOR.....33</p> <p>10.2. ABSOLUTE, RELATIVE POSITIONING REFERENCE AND TELEMETRY SYSTEM..34</p>			

 <b>PETROBRAS</b>	<b>TECHNICAL SPECIFICATION</b>	Nr: <b>I-ET-3010.2E-1359-940-P4X-001</b>	REV. <b>A</b>
	-		SHEET: 4 of 34
	TITLE: <b>OFFLOADING SYSTEM</b>		INTERNAL

## 1. INTRODUCTION

### 1.1. OBJECTIVE

The purpose of this technical specification is to describe the minimum requirements for the design, manufacturing, assembly, supply, installation and tests of OFFLOADING SYSTEM in conformance with relevant regulations and REFERENCE HULL 01 basic design documentation.

### 1.2. DEFINITIONS

**PACKAGE:** It is defined as an assembly of equipment supplied interconnected, tested and ready to operate, requiring only the available utilities from the Unit for the Package operation.

**PACKAGER:** It is defined as the responsible for project, assembly, construction, fabrication, testing and furnishing of the Package.

**OFFLOADING SYSTEM** the package name.

**OWNER:** PETROBRAS.

All definitions are found on I-ET-3010.00-1200-940-P4X-002 – GENERAL TECHNICAL TERMS

### 1.3. ABBREVIATIONS

BLS..... Bow Loading System

CS..... Classification Society

DPST..... Dynamic Positioning Shuttle Tanker

FAT..... Factory Acceptance Tests

FPSO..... Floating Production Storage and Offloading Unit

HMPE..... High Modulus Polyethylene

PRS..... Position Reference System

SOS..... Supervisory and Operation System

SOS-HMI..... Human Machine Interface of SOS

ST..... Shuttle Tanker

	TECHNICAL SPECIFICATION	Nr: I-ET-3010.2E-1359-940-P4X-001	REV. A
	-		SHEET: 5 of 34
	TITLE: OFFLOADING SYSTEM		INTERNAL
		ESUP	

## 2. NORMATIVE REFERENCES

### 2.1. INTERNATIONAL CODES, RECOMMENDED PRACTICES AND STANDARDS

The equipment will be designed and manufactured in accordance with the following codes and standards, if not mentioned otherwise.

- ABNT NBR 13545, Lifting purposes – shackles
- ABNT NBR 13715-2, Offshore structure – chain cable, part 2: Requirements and test methods
- AISC ASD latest edition (For shear, axial, bending strength, beam and column buckling of other than cylindrical members).
- API RP2A-WSD latest edition (For shear, axial, bending and buckling strength of cylindrical members and code checking of tubular joints. Also, for requirements for lifting analysis).
- ASME B16.5 – Pipe Flanges & Flanged Fittings
- ASME B31.3 – Process Piping
- AWS D1.1: 2000 Structural Welding Code – Steel
- Buoy Mooring Forum – SPM Hose System – Design Commentary, 1993 – OCIMF.
- Guide to Purchasing, Manufacturing and Testing of Loading and Discharge Hoses for Offshore Moorings, latest edition
- Guidelines for the Handling, Storage, Inspection and Testing of Hoses in the Field – OCIMF.
- Guidelines for the purchasing and testing of SPM hawsers - OCIMF, latest edition
- IMO MSC / Circ. 474 - Guidelines for Bow and Stern Loading and Unloading Arrangements on Oil Tankers.
- International Safety Guide for Oil Tankers & Terminal – ISGOTT.
- ISO 10325 – Fiber ropes - high modulus polyethylene Classification Society defined for the Hull scope.
- ISO 10554 - Polyamide fiber ropes – double braid construction
- Offshore Loading Safety Guidelines with special relevance to harsh weather zones – OCIMF, latest edition
- Recommendation for oil tanker manifolds and associated equipment, OCIMF; latest edition
- Rules and Regulations of the Classification Society.
- SPM hose ancillaries guide, OCIMF; latest edition.

	TECHNICAL SPECIFICATION	Nr: I-ET-3010.2E-1359-940-P4X-001	REV. A
	-		SHEET: 6 of 34
	TITLE: OFFLOADING SYSTEM		INTERNAL
			ESUP

## 2.2. BRAZILIAN CODES AND STANDARDS

- NR – Brazilian Federal Government Regulatory Norms (Normas Regulamentadoras NRs).
- NORMAM-01 – Normas da Autoridade Marítima para Embarcações Empregadas na Navegação em Mar Aberto.

## 2.3. CLASS APPROVAL AND CERTIFICATION

The PACKAGE shall be designed, manufactured and tested according to the design reference documents, normative requirements and in accordance with the latest editions of Classification Society Rules, Regulations and Standards.

## 3. REFERENCE DOCUMENTS

REF DOC NUMBER	REF DOC NAME
<b>3.1. REFERENCE HULL 01 FPSO BASIC DESIGN</b>	
<b>HULL SYSTEMS</b>	
I-DE-3010.2E-1350-944-P4X-003	CARGO SYSTEM
I-DE-3010.2E-5139-944-P4X-005	OFFLOADING HYDRAULIC SYSTEM
I-MD-3010.2E-1200-940-P4X-027	DESCRIPTIVE MEMORANDUM - HULL SYSTEMS
<b>OUTFITTING</b>	
I-DE-3010.2E-1351-140-P4X-001	HULL GENERAL NOTES AND TYPICAL DETAILS
<b>ERGONOMICS</b>	
I-ET-3010.2E-1350-196-P4X-002	ERGONOMICS REQUIREMENTS FOR HULL
<b>3.2. TYPICAL DOCUMENTS</b>	
<b>GENERAL</b>	
I-ET-3000.00-0000-940-P4X-002	SYMBOLS FOR PRODUCTION UNITS DESIGN
I-ET-3010.00-1200-940-P4X-002	GENERAL TECHNICAL TERMS
I-ET-3000.00-1200-940-P4X-001	TAGGING PROCEDURE FOR PRODUCTION UNITS DESIGN



**PETROBRAS**

TECHNICAL SPECIFICATION

Nr:

I-ET-3010.2E-1359-940-P4X-001

REV.

A

SHEET: 7 of 34

TITLE:

**OFFLOADING SYSTEM**

INTERNAL

ESUP

**CONSTRUCTION**

I-ET-3010.00-1200-955-P4X-001

WELDING

I-ET-3010.00-1000-970-P4X-002

REQUIREMENTS FOR NDT

I-ET-3010.00-1200-955-P4X-002

REQUIREMENTS FOR WELDING INSPECTION

I-ET-3010.00-0000-970-P4X-001

REQUIREMENTS FOR PROCEDURES AND PERSONNEL QUALIFICATION AND CERTIFICATION

**MECHANICAL**

I-ET-3010.00-1200-300-P4X-001

NOISE AND VIBRATION CONTROL REQUIREMENTS

I-ET-3010.00-1352-130-P4X-001

FLOOR GRATINGS, TRAY SYSTEMS AND GUARDRAILS MADE OF COMPOSITE MATERIALS

**PAINTING**

I-ET-3010.00-1200-956-P4X-002

GENERAL PAINTING

DR-ENGP-I-1.15

COLOR CODING

**SAFETY**

I-ET-3010.00-5400-947-P4X-002

SAFETY SIGNALING

DR-ENGP-M-I-1.3

SAFETY ENGINEERING GUIDELINE

**PIPING**

I-ET-3010.00-1200-251-P4X-001

REQUIREMENTS FOR BOLTING MATERIALS

I-ET-3010.00-1200-200-P4X-115

REQUIREMENTS FOR PIPING FABRICATION AND COMMISSIONING

**ELECTRICAL**

I-DE-3010.00-5140-700-P4X-003

GROUNDING INSTALLATION TYPICAL DETAILS

I-ET-3010.00-5140-700-P4X-001

SPECIFICATION FOR ELECTRICAL DESIGN FOR OFFSHORE UNITS

	TECHNICAL SPECIFICATION	Nr: I-ET-3010.2E-1359-940-P4X-001	REV. A
	-		SHEET: 8 of 34
	TITLE: OFFLOADING SYSTEM		INTERNAL
I-ET-3010.00-5140-700-P4X-002	SPECIFICATION FOR ELECTRICAL MATERIAL AND EQUIPMENT FOR OFFSHORE UNITS		
I-ET-3010.00-5140-700-P4X-003	ELECTRICAL REQUIREMENTS FOR PACKAGES FOR OFFSHORE UNITS		
I-ET-3010.00-5140-712-P4X-001	LOW-VOLTAGE INDUCTION MOTORS FOR OFFSHORE UNITS		
<b>INSTRUMENTATION AND AUTOMATION</b>			
I-ET-3010.00-1200-800-P4X-002	AUTOMATION, CONTROL AND INSTRUMENTATION ON PACKAGE UNITS		
I-ET-3010.00-1200-800-P4X-013	GENERAL CRITERIA FOR INSTRUMENTATION PROJECTS		
I-ET-3010.00-5520-888-P4X-001	AUTOMATION PANELS		
I-ET-3010.00-1200-800-P4X-015	REQUIREMENTS FOR TUBING AND FITTING (ALIGNED TO IOGP-JIP33 S-716)		
<b>TELECOM</b>			
I-ET-3010.00-5537-76F-PPT-001	POSITIONING AND NAVIGATION SYSTEMS FOR OFFSHORE LOADING SYSTEMS		
<b>3.3. SPECIFIC PROJECT DOCUMENTS</b>			
<b>GENERAL</b>			
I-DE-GENERAL ARRANGEMENT	GENERAL ARRANGEMENT		
I-DE-AREA CLASSIFICATION – GENERAL	AREA CLASSIFICATION – GENERAL		
I-ET-AUTOMATION INTERFACE OF PACKAGE UNITS	AUTOMATION INTERFACE OF PACKAGE UNITS		
I-ET-FIELD INSTRUMENTATION	FIELD INSTRUMENTATION		
I-ET-METOCEAN DATA	METOCEAN DATA		



	TECHNICAL SPECIFICATION	Nr: I-ET-3010.2E-1359-940-P4X-001	REV. A
	-		SHEET: 9 of 34
	TITLE: OFFLOADING SYSTEM		INTERNAL
			ESUP

I-MD-COMMISSIONING DESCRIPTIVE MEMORANDUM	COMMISSIONING DESCRIPTIVE MEMORANDUM
I-RL-GENERAL SPECIFICATION FOR AVAILABLE UTILITIES	GENERAL SPECIFICATION FOR AVAILABLE UTILITIES
I-RL-MOTION ANALYSIS	MOTION ANALYSIS

Table 1 – Specific Project Documents.

- Note: Table 1 documents title and number may vary slightly from one project to another. Project's document list shall be consulted to verify the correct document number and title.

#### 4. DESIGN REQUIREMENTS

##### 4.1. DESIGN CONDITIONS

- 4.1.1. PACKAGE Equipment shall be designed for a 30-year life in a corrosive offshore environment without the need for replacement of any major component due to wear, corrosion, fatigue, or material failure.
- 4.1.2. PACKAGER shall design the equipment for the full range of operational conditions as specified in this technical specification.
- 4.1.3. PACKAGE Equipment shall be designed with the compliance of the normative and design requirements as stated in this specification and complying with the technical parameters stated on the above item 3 with the FPSO REFERENCE HULL 01 basic design reference documents.

##### 4.2. SAFETY REQUIREMENTS

- 4.2.1. Personnel safety protection shall be provided according to Brazilian Regulatory Norms (NR) issued by Brazilian Government.
- 4.2.2. Warning signs in Brazilian Portuguese language shall be provided where risk of personnel injury exist.
- 4.2.3. Rotating equipment outer parts, such as pulleys, couplings, belts and flywheels, shall have rigid protection, according to NR-12, manufactured with aluminum ASTM B211 and shall be capable of being easily removed.
- 4.2.4. In accordance with the requirements of SOLAS II-1, Regulation 3-5, and MSC.1/Circ. 1379, all equipment and material to be supplied by PACKAGER must be "asbestos free".
- 4.2.5. Safety signaling shall be in full compliance with I-ET-3010.00-5400-947-P4X-002 – SAFETY SIGNALING.
- 4.2.6. For additional safety requirements refer to DR-ENGP-M-I-1.3 – SAFETY ENGINEERING GUIDELINE.

	TECHNICAL SPECIFICATION	Nr: I-ET-3010.2E-1359-940-P4X-001	REV. A
	-		SHEET: 10 of 34
	TITLE: OFFLOADING SYSTEM		INTERNAL
		ESUP	

### 4.3. NOISE AND VIBRATIONS

4.3.1. Noise and vibrations limits shall be in conformance with I-ET-3010.00-1200-300-P4X-001 – NOISE AND VIBRATION CONTROL REQUIREMENTS.

### 4.4. MOTIONS AND ACCELERATION

4.4.1. All equipment shall be able to withstand with the UNIT subjected to 100-year return period environmental conditions.

4.4.2. All equipment shall be able to operate with the UNIT subjected to 1-year return period environmental conditions.

4.4.3. All environmental conditions are defined in I-ET-METOCEAN DATA.

4.4.4. For the Hull loading conditions details and the maximum designed operational trim and heel inclinations refer to I-ET-3010.00-1350-960-P4X-003 – DESIGN PREMISSES - NAVAL ARCHITECTURE.

4.4.5. For the FPSO displacement and accelerations refer to I-RL-MOTION ANALYSIS.

4.4.6. PACKAGE shall withstand inertial forces during transportation from construction site to the final offshore location.

### 4.5. OFFLOADING OPERATION TOTAL TIME AND FREQUENCY

4.5.1. The entire Offloading System shall be designed and manufactured for a lifetime according to the related oil field project. A minimum of 110 utilizations per year shall be considered as a general design premise.

4.5.2. On average, the offloading operations will be performed at least once a week and shall not take more than 36 h (thirty-six hours). Notwithstanding the above, the system shall be designed to offload one million (1,000,000) barrels of crude oil to the DPST in no more than 24 (twenty-four) hours (pumping time). The offload rate shall be proportional to different volumes, e.g., five hundred thousand (500,000) barrels of crude oil in no more than 12 (twelve) hours.

4.5.3. There shall be no restrictions to either start, proceed or finish offloading-related connecting or disconnecting operations during night time.

4.5.4. The maximum FPSO offloading operation rate is obtained with 06 (six) cargo pumps running with an overall total rate of 7,200 m<sup>3</sup>/h. For the cargo pumps rates latest information refer to I-FD-3010.2E-1350-311-P4X-001 – CARGO PUMPS (B-1350501A/T).

### 4.6. CRUDE OIL DATA

4.6.1. For the crude oil data refer to I-FD-3010.2E-1350-311-P4X-001 – CARGO PUMPS (B-1350501A/T).

	TECHNICAL SPECIFICATION	Nr: I-ET-3010.2E-1359-940-P4X-001	REV. A
	-		SHEET: 11 of 34
	TITLE: OFFLOADING SYSTEM		INTERNAL
			ESUP

## 5. MOORING EQUIPMENT

### 5.1. SCOPE OF SUPPLY

5.1.1. For the Mooring system PACKAGER shall supply:

GN-Z-1359502-02	HAWSER REEL (AFT)
GN-Z-1359506-02	HAWSER REEL (FWD)
PN-GN-Z-1359502-02	AFT OFFLOADING HAWSER WINCH & REEL CONTROL PANEL
PN-GN-Z-1359506-02	FWD OFFLOADING HAWSER WINCH & REEL CONTROL PANEL
Mooring Hawser Assembly	Stud links, fiber ropes, thimbles and shackles

Table 2 – Offloading Mooring system scope of supply.

### 5.2. GENERAL

5.2.1. Offloading mooring system PACKAGE comprises the Hawser Assembly, Hawser Reel and the related outfitting for each loading station, providing a complete arrangement with characteristics in accordance with these specifications.

5.2.2. On the FPSO side, the hawser / chafe chain shall be permanently attached to a holding point on the FPSO.

5.2.3. The load monitoring system shall be designed to allow a continuous hawser tension reading and recording in the CCR and also in the AFT / FWD OFFLOADING HAWSER WINCH & REEL CONTROL PANEL (PN-GN-Z-1359502-02 / PN-GN-Z-1359506-02) control panels.

- Note: since the hawser tension data will be stored in a computer, the necessary hardware such as cables, connectors and panels shall be provided. This data shall be made available to the PETROBRAS onboard representatives on a regular basis.

5.2.4. The chafe chain for mooring system shall comply with NBR 13715-2 Guideline, specifically to prevent links not in compliance with this Guideline.

5.2.5. Quick release mooring hook (QRMH) **shall not be** supplied for the FPSO, this system shall be installed on the Shuttle Tanker.



PETROBRAS

TECHNICAL SPECIFICATION

Nr: I-ET-3010.2E-1359-940-P4X-001

REV. A

SHEET: 12 of 34

TITLE: OFFLOADING SYSTEM

INTERNAL

ESUP

### 5.3. MOORING HAWSER ASSEMBLY

5.3.1. From the chafing chain part on hawser winch to the messenger line, the mooring hawser assembly comprises the following accessories.

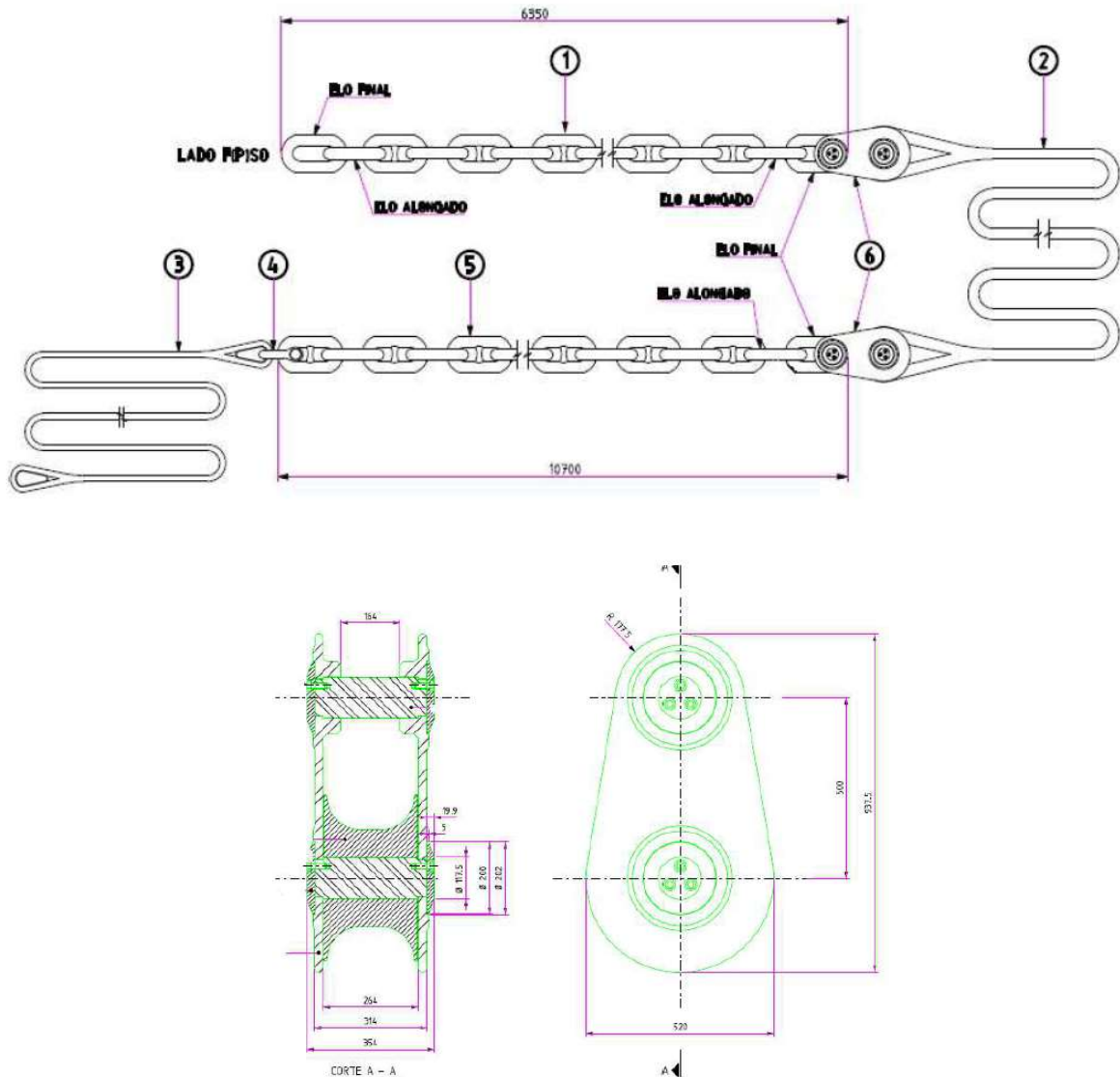



Figure 5-1– Rope-chain conector.

- 1) Stud-link chain cable, ABNT NBR 13715-2, R4, ND 76 mm, both terminals with enlarged end link.
- 2) Fiber rope, ISO 9554, RN 168 mm, polyamide, higher-strength (hs), double braided construction, MBF 5280 kN, length 150 m, eye splice plus polyurethane coating with RCS certificate of approval.
- 3) Fiber rope, HMPE, ISO 10325, type C (covered), 12 strand, RN 38 mm, MBF 909 kN, with eye splices, length 220 m.

	TECHNICAL SPECIFICATION	Nr: I-ET-3010.2E-1359-940-P4X-001	REV. A
	-		SHEET: 13 of 34
	TITLE: OFFLOADING SYSTEM		INTERNAL

- 4) Bow shackle ABNT NBR 13545, grade 8S, bolt type pin with hexagon head, hexagon nut and AISI 316 split cotter pin, WLL 40 t (body 46 mm, pin 52 mm, width between eyes 77 mm).
- 5) Stud-link cable, ABNT NBR 13715-2, R4, ND 76 mm, one terminal with enlarged and end link, other terminal with common link, length 10 m
- 6) Thimble according to picture above.

#### 5.4. MOORING HAWSER CHARACTERISTICS

- 5.4.1. Mooring hawser material shall be polyamide fiber in accordance with ISO 10554.
- 5.4.2. Mooring hawser length shall be 150 m after permanent stretch and shall be in accordance with ISO 9554.

#### 5.5. HAWSER REEL (AFT) (GN-Z-1359502-02) AND HAWSER REEL (FWD) (GN-Z-1359506-02)

5.5.1. The UNIT shall be equipped with a hydraulically driven winch herein called Hawser Reel and stands for HAWSER REEL (AFT) (GN-Z-1359502-02) and HAWSER REEL (FWD) (GN-Z-1359506-02) at each offloading station to launch, retrieve, spool and store the mooring hawser.

5.5.2. Hawser Reel shall have the following main functions:

- To storage the entire mooring hawser wire and ropes.
- To have Hawser spooling mechanism.
- To have Hawser load monitoring.

5.5.3. Hawser Reel design speed shall be as the following:

- Minimum launching speed.....0.6 m/s
- Minimum retrieval speed.....0.3 m/s

5.5.4. Hawser Reel shall have the minimum design requirements:

- Drum capacity to store one hawser assembly including the chafe chain and the messenger lines.
- Load monitoring system (load cell range 0 – 5000 kN).
- Fail Safe Brake System automatically activated in case of hydraulic system failure.
- Driving system: hydraulic driven with local (nearby the winch) control console.

	TECHNICAL SPECIFICATION	Nr: I-ET-3010.2E-1359-940-P4X-001	REV. A
	-		SHEET: 14 of 34
	TITLE: OFFLOADING SYSTEM		INTERNAL
<p>5.5.5. Hawser Reel (AFT) (GN-Z-1359506-02) shall be installed at the extreme Hull stern and the Hawser Reel (FWD) (GN-Z-1359502-02) shall be installed at the extreme Hull bow in a clear area with no obstacles for the safe hawser operation to launch, retrieve and spool the mooring hawser assembly for the connection with the shuttle tanker.</p> <ul style="list-style-type: none"> <li>▪ Note: the shuttle tanker operational area shall be verified according to the offloading operational sector for the shuttle tankers as indicated on 10.1.</li> </ul> <p>5.5.6. Hawser Reel shall be all welded steel construction</p> <p>5.5.7. The winch drum shall be horizontal or vertical type. No other arrangement will be accepted. If the drum is a horizontal type, it shall be split in two parts, one for the hawser assembly and the other for the chafing chain. If the drum is a vertical type, the bottom plate of the drum shall have a suitable diameter to accommodate all metal components of the mooring hawser assembly.</p> <p>5.5.8. Hawser Reel control system</p> <p>5.5.8.1. A local control console shall be installed adjacent to Hawser Reel of each offloading station with a clear view of the Offloading operational sector. The control consoles shall be provided with the following functions:</p> <ul style="list-style-type: none"> <li>▪ Hawser Reel control (reel-in, pay-out, spooling controls).</li> <li>▪ HPU control (start, stop, emergency stop).</li> <li>▪ Monitoring of the mooring hawser tension.</li> </ul> <p>5.5.8.2. Local control console buttons shall not allow any release of the mooring system or hose string inadvertently. This specific button shall be provided with a transparent plastic cover or other similar alternative solution for this purpose.</p> <p>5.5.8.3. To allow a smooth operation the hydraulic oil pressure supply line for the Hawser Reel shall be provided with a proportional directional control valve to allow a variable speed for the winches.</p> <p>5.5.9. Hawser Reel safety issues</p> <p>5.5.9.1. Adequate lighting for the Hawser Reel shall be provided for the safe operation on both bow and stern offloading stations covering local control consoles, deck work area, access, platforms, etc.</p> <p>5.5.9.2. Retrieving the mooring hawser by the middle of the cable is not acceptable.</p> <p>5.5.9.3. Chafe chain installation and disconnection shall be designed to ensure a safe operation without exposing people near tensioned lifting accessories.</p>			

	TECHNICAL SPECIFICATION	Nr: I-ET-3010.2E-1359-940-P4X-001	REV. A
	-		SHEET: 15 of 34
	TITLE: OFFLOADING SYSTEM		INTERNAL

#### 5.5.10. Hawser Reel maintenance issues

- PACKAGER shall provide devices or mechanisms to allow adequate maintenance of the Hawser Winch drum with no crane assistance.
- All equipment shall be provided with suitable marine treatment.
- To ensure the Hawser Winch will be fully operational and available when required, it is essential that the design takes inspection and maintenance activities into consideration.
- All grease nipples shall be located on the Main Deck to allow easy access and adequate lubrication of the Hawser Winch.

### 6. OFFLOADING EQUIPMENT SPECIFICATION

#### 6.1. SCOPE OF SUPPLY

6.1.1. PACKAGER shall supply the offloading equipment and components to perform the transference of stabilized crude oil from the FPSO cargo oil tanks to the tandem moored shuttle tanker with the herein minimum PETROBRAS requirements, safety recommendations and normative rules, regulations and Class requirements.

6.1.2. Identical offloading equipment shall be supplied for the bow and stern offloading stations as the following:

TAG	DESCRIPTION	QUANTITY
Z-1359502	OFFLOADING SYSTEM (AFT)	1 X 100%
Z-1359506	OFFLOADING SYSTEM (FWD)	1 X 100%
GN-Z-1359502-01	OFFLOADING HOSE REEL (AFT)	1 X 100%
GN-Z-1359506-01	OFFLOADING HOSE REEL (FWD)	1 X 100%
PN-GN-Z-1359502-01	OFFLOADING HOSE REEL CONTROL PANEL (AFT)	1 X 100%
PN-GN-Z-1359506-01	OFFLOADING HOSE REEL CONTROL PANEL (FWD)	1 X 100%
UH-1359506A	OFFLOADING HYDRAULIC POWER UNIT	1 X 100%
UH-1359506B	OFFLOADING HYDRAULIC POWER UNIT	1 X 100%
PN-UH-1359506A	OFFLOADING HYDRAULIC POWER UNIT CONTROL PANEL	1 X 100%



	TECHNICAL SPECIFICATION	Nr: I-ET-3010.2E-1359-940-P4X-001	REV. A
	-		SHEET: 16 of 34
	TITLE: OFFLOADING SYSTEM		INTERNAL

PN-UH-1359506B	OFFLOADING HYDRAULIC POWER UNIT CONTROL PANEL	1 X 100%
Z-1359508	HOSE REEL SPOOLING DEVICE (AFT)	1 X 100%
Z-1359504	HOSE REEL SPOOLING DEVICE (FWD)	1 X 100%
GN-Z-1359502-04	EMERGENCY OFFLOADING STATION/WINCH (AFT)	1 X 100%
GN-Z-1359506-04	EMERGENCY OFFLOADING STATION/WINCH (FWD)	1 X 100%
-	CONTROL CONSOLE	2 X 100%
-	SPECIAL DEVICES AND MECHANISMS	2 X 100%
-	OFFLOADING HOSE STRING	2 X 100%
-	OUTBOARD HOSE TERMINATION PIECE (NSV)	2 X 100%
-	DETACHABLE HOSE BRIDLE	2 X 100%
-	HOSE MESSENGER LINE WINCH	2 X 100%

Table 4 – PACKAGER scope of supply.

6.1.3. PACKAGER shall provide all safety means for handling and maintaining the Offloading system, by supplying:

- Access platforms for safe inspections and maintenance, including the maintenance of the NSV. See item 6.2.7.
- Safe protections for workers.
- Storage room for steel wire, ropes and NSV.
- Means of internal flushing the offloading hose string (according to internationally recognized procedures).
- Means of safe handling the emergency offloading hose and facilities to perform its pull-in / pull-out, by using proper equipment, such as winch and lifting flange. It will not be accepted procedures where the operators are in an unsafe position near tensioned hose, hawser, wires or ropes.
- Means of safely handling messenger ropes and facilities to perform reel in or pay out, by using proper equipment, such as winch and shackles.
- Flanges for both offloading hoses (main and emergency) shall be of 20 inches class 300 type.



	<b>TECHNICAL SPECIFICATION</b>	Nr: <b>I-ET-3010.2E-1359-940-P4X-001</b>	REV. <b>A</b>
	-		SHEET: 17 of 34
	TITLE: <b>OFFLOADING SYSTEM</b>		INTERNAL
<ul style="list-style-type: none"> <li>▪ It shall be possible to drain the offloading hose by the FPSO.</li> <li>▪ It shall be possible to carry out inertization of the offloading hose.</li> <li>▪ There shall be no interference in the route of the hose pull-in cables from puller and/or protrusions that can cause a damage in the offloading hose strings.</li> <li>▪ The spooling device shall be positioned with an allowance for free space in deck for other equipment. It shall also be free of edges or corners that could damage the offloading hose strings.</li> <li>▪ The structure of the spooling device shall be designed to withstand the impact of the hose during offloading operation in bad weather conditions.</li> </ul> <p><b>6.2. GENERAL SPECIFICATION</b></p> <p>6.2.1. Controls to start, stop and manage speed of the Hose Reel shall be located in the control console cabin near by the Hose Reel, but keeping the operator in a safe place protected from the moving devices and whipping wires or ropes, and also sheltered from the weather conditions.</p> <p>6.2.2. Offloading Equipment shall be dimensioned to withstand frequent start / stop / reel in / pay out loads, which are customary in an operation / inspection routine.</p> <p>6.2.3. Offloading operations can occur even at night, thus, in both offloading stations it shall be provided good illumination in order to allow safe operations and also inspections of the hoses and mooring system at both day and night.</p> <p>6.2.4. Sharp edges and corners on the internal and external structures (deck and hull) of the Offloading system are not allowed, including structures of the spooling device, in order to avoid damage on the hoses, cables and ropes.</p> <p>6.2.5. Offloading System hazardous scenarios protection devices:</p> <p>6.2.5.1. Offloading System shall have devices to mitigate the hydraulic transient as burst discs to destinate the cargo oil back to the cargo tanks on an overpressure scenario. Alternative solutions other than burst discs shall be submitted to PETROBRAS for appraisal.</p> <ul style="list-style-type: none"> <li>▪ Note 1: Burst discs shall be provided with a sensor indicator, to be triggered in case of disc rupture. In case of disc burst, a visual and sound alarm shall be initiated in the CCR. The Offloading System shall stop offloading pumping automatically.</li> <li>▪ Note 2: for Burst discs functional details refer to I-DE-3010.2E-1350-944-P4X-003 – CARGO SYSTEM.</li> </ul>			

	TECHNICAL SPECIFICATION	Nr: I-ET-3010.2E-1359-940-P4X-001	REV. A
	-		SHEET: 18 of 34
	TITLE: OFFLOADING SYSTEM		INTERNAL

6.2.5.2. Regarding ESD (Emergency Shutdown) system, a shutdown valve shall be installed upstream to both offloading systems, bow and stern. This shutdown valve shall be of a single effect valve, fail closed type.

- Note: for SDVs position, type and actuation requirements refer to I-DE-3010.2E-1350-944-P4X-003 – CARGO SYSTEM.

6.2.6. Offloading System shall have arrangements and facilities to allow the proper internal cleaning of this system (including the offloading hose string), which will be performed immediately after every offloading operation in a so called “backflushing operation”.

6.2.7. PACKAGE equipment access ladders, platforms, gratings and any other access device shall comply with I-ET-3010.00-1352-130-P4X-001 - FLOOR GRATINGS, TRAY SYSTEMS AND GUARDRAILS MADE OF COMPOSITE MATERIALS. Metallic material is also acceptable and I-DE-3010.2E-1351-140-P4X-001 – HULL GENERAL NOTES AND TYPICAL DETAILS, item 3.23, shall be followed for metallic grating requirements.

### 6.3. HOSE REEL

6.3.1. The Unit shall be equipped with a welded steel construction, hydraulically driven Hose Reel at each offloading station, bow and stern, designed to handle and to store the entire offloading hose string.

6.3.2. The maximum height of the Hose Reel drum in relation to the Hull deck shall be 2.8 meters and the drum diameter shall be at least 8.0 meters.

6.3.3. The Hose Reel shall be designed to store the hose string in one layer, to avoid any damage to the hose cover and floating layers. Thus, it shall not contain sharp edges or any other part or structure that could damage the hose or hose’s cover.

6.3.4. The Hose Reel shall have the minimum capacity to store the whole offloading hose string, a spooling mechanism and a hose load monitoring.

6.3.5. The minimum launching or retrieving speed is 0.3 m/s, considering the worst environmental design condition as defined on item 4.4.

6.3.6. Hose Reel power and torque requirements:

6.3.6.1. Hose Reel shall be capable of reeling in (recover) the offloading hose string full of seawater at the design speed and with the FPSO at the minimum operational draught. Additionally, the following remarks shall be considered:

a) To the hose string vertical height between Hose Reel and sea water level (FPSO in a static condition at minimum operational draught) it shall be added an extra hose height to account for FPSO motions.

b) Forces due to vertical acceleration at hose reel obtained from detailed design Motion Analysis for 1-year return period environment conditions as defined on item 4.4.2.

	TECHNICAL SPECIFICATION	Nr: I-ET-3010.2E-1359-940-P4X-001	REV. A
	-		SHEET: 19 of 34
	TITLE: OFFLOADING SYSTEM		INTERNAL
<p>c) Dynamic factor of 1.3.</p> <p>d) Offloading hose string load shall consider:</p> <ul style="list-style-type: none"> <li>▪ The offloading hose string weight with 10% allowance added to account for any difference in the weight of hoses.</li> <li>▪ All the Hose Reel friction loads.</li> <li>▪ The weight of the NSV installed on it.</li> </ul> <p>e) Note: the Hose Reel power and torque dimensioning shall be submitted to OWNER for approval.</p> <p>6.3.6.2. Hose Reel shall be designed to recover the offloading hose string totally paid out and fully submerged. For this condition, a retrieval speed less than required on item 6.3.5 will be accepted.</p> <p>6.3.6.3. For the Hose Reel functional test condition at the shipyard the FPSO shall be considered at the minimum quayside draft and with the offloading hose string fully installed and fully loaded with sea water inside.</p> <ul style="list-style-type: none"> <li>○ Note 1: for this scenario the launching / retrieval speed may not be the design speed. PACKAGER shall advise the proper speed for this test condition.</li> <li>○ Note 2: this is a functional test scenario to be detailed on I-MD-COMMISSIONING DESCRIPTIVE MEMORANDUM.</li> </ul> <p>6.3.7. Hose Reel drive system</p> <p>6.3.7.1. The gearboxes are the hydraulic driven devices responsible for driving the offloading Hose Reel. Each hydraulic gearbox rate of operation is dependent on the quantity of hydraulic gearboxes available for each Hose Reel. All gearboxes are intended to operate in parallel.</p> <p>6.3.7.2. Hose Reel gearboxes quantity shall be defined by PACKAGER and all of these gearboxes shall operate simultaneously at the design condition as above detailed on item 6.3.6.</p> <ul style="list-style-type: none"> <li>▪ Note 1: as a contingency scenario, Offloading System, bow and stern, shall be able to operate at the design condition and design loads with one of the gearboxes out of operation <b>for a short period</b> and at the minimum specified speed (as indicated on item 6.3.5).</li> <li>▪ Note 2: the purpose of this contingency operation is to ensure that the system is able to safely conclude an ongoing offloading operation in case of malfunction in one of the gearboxes.</li> </ul> <p>6.3.8. Hose Reel control, locking mechanism and brake system</p>			

	<b>TECHNICAL SPECIFICATION</b>	Nr: <b>I-ET-3010.2E-1359-940-P4X-001</b>	REV. <b>A</b>
	-		SHEET: 20 of 34
	TITLE: <b>OFFLOADING SYSTEM</b>		INTERNAL
<p>6.3.8.1. To avoid peak loads in the pinions and racks, a joystick control shall be installed at the offloading control console cabin. It shall be allowed to control start, stop and rotation speed, allowing a smooth movement of the Hose Reel. The pressure supply line shall be provided with proportional directional control valve to allow variable speed.</p> <p>6.3.8.2. The locking device consists of a hydraulically operated pin or arm that engages on the locking holes mounted to the flange of the reel. In case of the hydraulic system failure, the pin or arm shall be manually operated. This locking device shall be able to lock hose reel in at least twelve symmetrical positions. Sensors shall indicate to the reel operator if it has been locked or unlocked.</p> <p>6.3.8.3. The Hose Reel drive units shall be supplied with an integrated hydraulically operated fail-safe brake. The gearboxes shall be able to withstand the Hose Reel stopped prior or after the actuation of the static brake.</p> <p>6.3.8.4. In each Offloading system, bow and stern, it shall be installed a brake delay system in the parking brake line in order to be able to keep the pressure on the parking brakes avoiding a “crash stop” on the Hose Reel, avoiding any issues due to inertial movements.</p> <p>6.3.9. Hose Reel safety issues</p> <p>6.3.9.1. The design of the Hose Reel and its auxiliary equipment shall allow inspection and maintenance without exposing people to tensioned accessories. Including hose string reel in and pay out operations.</p> <p>6.3.9.2. Adequate lighting shall be provided for the Hose Reels safe operation on both bow and stern offloading stations covering local control consoles, deck work area, access, platforms, etc.</p> <p>6.3.9.3. The size and angle of the goose neck and flange assembly must allow the connection of first of reel hose with a 1m long spool.</p> <p>6.3.10. Hose Reel handling system</p> <p>6.3.10.1. PACKAGER shall provide pull-in wire ropes to allow for offloading hose string removal and reinstallation whilst offshore. The pull-in wire ropes shall be permanently connected on the Hose Reel by means of pad-eyes. The pad-eye to connect the pull-in cables shall not offer a risk of damaging the hoses. Alternative solution shall be issued to PETROBRAS for appraisal.</p> <ul style="list-style-type: none"> <li>▪ Note: the padeyes and pull-in wire ropes arrangement and drawings shall be submitted to PETROBRAS for appraisal.</li> </ul> <p>6.3.10.2. There shall be an opening in the Hose Reel, over the gooseneck position, with pad eyes (SWL 15 t) installed on the internal structure of the reel, in order to assist during the offloading hose string pull-in operation, with the</p>			

	TECHNICAL SPECIFICATION	Nr: I-ET-3010.2E-1359-940-P4X-001	REV. A
	-		SHEET: 21 of 34
	TITLE: OFFLOADING SYSTEM		INTERNAL

connection of the hose first section with the Hose Reel load flange. Alternative solution shall be issued to PETROBRAS for appraisal.

6.3.11. For emergency operation in case of failure of the Hose Reel drive units, the offloading hose string shall be reeled on the Hose Reel drum by means of a redundant hydraulically driven mechanism. Start, speed control and stop of the emergency operation shall be done by a remote control, keeping the operator in a safe distance from the Hose Reel.

6.3.12. PACKAGER shall provide devices or mechanisms to allow adequate maintenance without crane assistance.

- Note 1: all equipment shall be provided with suitable marine treatment.
- Note 2: to ensure the hose reel operability and availability when required it is essential that the design takes inspection and maintenance activities into consideration.

#### 6.4. HOSE REEL SPOOLING DEVICE

6.4.1. The spooling device shall be hydraulically operated and assembled on the Hose Reel support structure. Spooling device shall assist in smooth spooling-on of the offshore hose string onto the reel.

6.4.2. The main structure of hose spooling device shall not be positioned on a deck below the deck where hose reel is installed.

#### 6.5. OFFLOADING HYDRAULIC POWER UNITS (UH-1359506A/B)

6.5.1. There shall be one (1 x 100%) Offloading Hydraulic Power Unit (UH-1359506A) to generate hydraulic power for the Aft Offloading System and another one (1 x 100%) Offloading Hydraulic Power Unit (UH-1359506B) for the Fwd Offloading System.

6.5.2. Each Offloading Hydraulic Power Unit (UH-1359506A/B) shall be electrical driven type, assembled on a single skid and designed to be installed in a non-hazardous area.

6.5.3. Offloading Hydraulic Power Unit (UH-1359506A/B) shall be supplied with the minimum following components:

- a dedicated hydraulic oil reservoir,
- a minimum of two (2 x 100%) power pumps and at least a circulation pump,
  - Note: The hydraulic oil power pumps may have 3 x 50% configuration or more, always keeping at least one stand-by pump.
- hydraulic accumulators,
- drip trays with drain points for the Hull draining system.

	TECHNICAL SPECIFICATION	Nr: I-ET-3010.2E-1359-940-P4X-001	REV. A
	-		SHEET: 22 of 34
	TITLE: OFFLOADING SYSTEM		INTERNAL

6.5.4. Offloading Hydraulic Power Unit (UH-1359506A/B) shall be controlled by the Offloading Hydraulic Power Unit Control Panel (PN-UH-1359506A/B) with start / stop command and visual / audible alarms.

- Note: for the Offloading Hydraulic Power Unit Control Panel (PN-UH-1359506A/B) location requirements refer to I-ET-3010.00-5140-700-P4X-003 – ELECTRICAL REQUIREMENTS FOR PACKAGES FOR OFFSHORE UNITS.

6.5.5. Offloading Hydraulic Power Unit (UH-1359506A/B) shall be dimensioned to attend the following cases:

1. Hose reel at the normal operation running at the design conditions as detailed on item 6.3.6.
2. Hawser Reel at the design power and design speed range as detailed on item 5.5.3.
3. Hose Reel, Hawser Reel and a Messenger Winch in a simultaneous and critical / contingency operational condition.

- Note: for this scenario, all HPU pumps including the stand-by pump may be used. In this case, the Hose Reel and winches operational speed shall not be necessarily the design speed for that equipment.

6.5.6. Offloading Hydraulic Power Unit (UH-1359506A/B) shall be fresh water cooled type with redundant heat exchangers.

6.5.7. Offloading Hydraulic Power Unit (UH-1359506A/B) shall have an interlocking system for the low level of hydraulic oil reservoir or for the admission valves closed with alarm and indication on the local control panel and CCR.

6.5.8. For additional details refer to I-DE-3010.2E-5139-944-P4X-005 – OFFLOADING HYDRAULIC SYSTEM.

6.5.9. Hydraulic tubing, fittings and valves shall comply with I-ET-3010.00-1200-800-P4X-015 REQUIREMENTS FOR TUBING AND FITTING (ALIGNED TO IOGP-JIP33 S-716).

## 6.6. CONTROL CONSOLES

6.6.1. A main console installed in a control cabin shall provide manual controls comprising the following main functions for the Hose Reel:

- The rotation speed of the Hose Reel.
- The linear speed of the spooling device.
- Hawser Reel axial tension monitoring (\*).
- Emergency shutdown switch (\*).

	TECHNICAL SPECIFICATION	Nr: I-ET-3010.2E-1359-940-P4X-001	REV. A
	-		SHEET: 23 of 34
	TITLE: OFFLOADING SYSTEM		INTERNAL

- Locking device switch.
- Locking device position status (\*).

(\*) Functions or signals required in the CCR.

6.6.2. The control console cabin shall be located as near as safely possible to the Hose Reel in a platform providing a good and full visibility of the offloading hose strings reeling. It shall be possible to control, monitor and operate the Hose Reel by a single person located at the control cabin.

6.6.3. An emergency shutdown switch shall also be provided for installation near the spooling device.

6.6.4. Hose Reel local control consoles shall be installed inside a weatherproof cabin.

6.6.5. Additionally, another two (02) weatherproof cabins (one aft and another fwd), similar to the cabins of item 6.6.4, shall be provided by PACKAGER as a station (protected from weather) for the crew member that is in charge to witness the whole offloading operation nearby the Offloading station.

6.6.5.1. Aft and Fwd cabin shall be positioned on the same deck of Hawser Winch and Hose Reel. The final position shall be defined by PACKAGER / HULL SUPPLIER considering a safe position from tensioned cables and hoses.

6.6.5.2. The purpose of the above mentioned cabins supply and installation is to comply with Brazilian regulation NR-21. For more details refer to I-ET-3010.2E-1350-196-P4X-002 – ERGONOMICS REQUIREMENTS FOR HULL.

6.6.5.3. The cabin for the Hose Reels local controls shall not be used for this purpose.

**6.7. SPECIAL DEVICES AND MECHANISMS**

6.7.1. Crude oil swivel shall have 20 inches diameter, ANSI B16.5 class 300. To be mounted on the drive side of the Hose Reel.

6.7.2. Locking device: hydraulically operated pin or arm that engages locking holes mounted on the Hose Reel structure. No single hydraulic failure shall lead to stop operations in Hose Reel. In case of hydraulic system failure, the pin or arm shall be manually operated.

6.7.3. Inboard Hose Termination Piece (IHTP): Offloading System **shall not** have an IHTP. Connections for quick release the offloading hose from FPSO side (Hose Reel gooseneck) **are not allowed**. Emergency disconnections shall be provided at shuttle tanker side only by the means of hose NSV and shuttle tanker bow loading system.

**6.8. OFFLOADING HOSE STRING**

6.8.1. Two (02) reinforced rubber offloading hose string, field proven type without failure



	TECHNICAL SPECIFICATION	Nr: I-ET-3010.2E-1359-940-P4X-001	REV. A
	-		SHEET: 24 of 34
	TITLE: OFFLOADING SYSTEM		INTERNAL

tracking records (to be submitted to PETROBRAS analysis prior to equipment's purchase), for each hose reel, polyurethane elastomer covered, DOUBLE CARCASS type, approximately 230 m (two hundred and thirty meters) length, working pressure of 300 psi (21 bar), including sections with 10.7 m length sections, end fittings flanged according to ANSI B16.5 Class 300 shall be provided and installed in accordance with the OCIMF guidelines as given in the "Guide to Purchasing, Manufacturing and Testing of Loading and Discharge Hoses for Offshore Moorings", latest edition.

6.8.2. Each offloading hose string configuration comprises the following:

- a. One (01) end section for the ST end, 20" nominal diameter, Tanker Rail type, 40% net buoyancy, considering one outboard hose termination piece fitted (North Sea Valve, NSV).
- b. One (01) segment, 20" nominal diameter, Regular Floating Hoses (35%).
- c. One (01) segment, 20" nominal diameter, Negative Floating Hose (-10%).
- d. Intermediate segments, 20" nominal diameter, Regular Floating Hoses (35%).
- e. Two (02) segments, 20" nominal diameter, Negative Floating Hose (-10%).
- f. One (01) segment, 20" nominal diameter, Regular Floating Hose (35%).
- g. One (01) segment, 20" nominal diameter, Reinforced first off reel type, regular floating hose (20%).
  - Note: 20" (twenty) nominal diameter is considered the minimum and most suitable specification for PETROBRAS. However, it is HULL SUPPLIER's responsibility to verify if this minimum diameter fulfills the requirement to offload one (01) million barrels of crude oil to the ST in not more than 24 (twenty-four) hours. HULL SUPPLIER shall advise PETROBRAS about the need to modify the hose string minimum diameter if necessary.

6.8.3. The following components and accessories shall be included on each offloading hose string:

- a. One (01) outboard hose termination piece (flanges ANSI B16.5 Class 300) as detailed on item 6.9.
- b. One (01) detachable hose bridle as detailed on item 6.10.
- c. One (01) hose messenger line.

6.8.4. General remarks



	<b>TECHNICAL SPECIFICATION</b>	Nr: <b>I-ET-3010.2E-1359-940-P4X-001</b>	REV. <b>A</b>
	-		SHEET: 25 of 34
	TITLE: <b>OFFLOADING SYSTEM</b>		INTERNAL
<p>a. The tanker rail hose shall come with additional integrated buoyancy in DPST side, in order to provide buoyancy to the outboard hose termination piece during hose transferring.</p> <p>b. PACKAGER shall supply two (02) hose intermediate segments and one (01) hose end section as spares for the offloading hose string.</p> <p>c. Stainless steel bolts (ASTM A193 Grade B8M Class 1) and nuts (ASTM A194 Grade 8M – AISI-316) shall be provided to make up the flanged connections.</p> <p>d. The electrical continuity of the hose string should be according to OCIMF guidelines and the requirements from the Classification Society.</p> <p>e. No marine breakaway coupling or similar devices will be accepted as a component of the hose string.</p> <p>f. The internal lining of the hoses must be designed to work with oil with a 50% aromatic content.</p> <p><b>6.9. OUTBOARD HOSE TERMINATION PIECE (NORTH SEA VALVE)</b></p> <p>6.9.1. The outboard hose termination piece shall consist mainly of one valve DN 20” x 300 psi (21 bar) with body, disc, and a spring. The North Sea Valve (NSV) shall have adequate dimensions and design to connect at the BLS of the DPST.</p> <p>6.9.2. The valve spring shall keep the hose closed during the loading operations interval and shall automatically close the hose in an emergency. A built-in time delay function shall be provided to prevent pressure surge in the system.</p> <p>6.9.3. NSV shall be designed with the minimum possible pressure drop. The hose termination piece shall have a suitable swivel ring to which the hose bridle is connected. This swivel shall properly work to allow for the hose rotation, since twists may occur in the hose messenger during launching / pulling the hose from the UNIT to the ST.</p> <p>6.9.4. With the Hose Reel in parking position, the NSV shall be stored onboard within a dedicated area provided with coamings to contain any possible oil spillage, to ensure no oil spillage overboard.</p> <ul style="list-style-type: none"> <li>▪ Note: for offloading stations coaming requirements refer to I-DE-3010.2E-5330-944-P4X-002 – HULL EXPOSED AREAS DRAINING SYSTEM.</li> </ul>			



PETROBRAS

TECHNICAL SPECIFICATION

Nr:

I-ET-3010.2E-1359-940-P4X-001

REV.

A

SHEET: 26 of 34

TITLE:

OFFLOADING SYSTEM

INTERNAL

ESUP

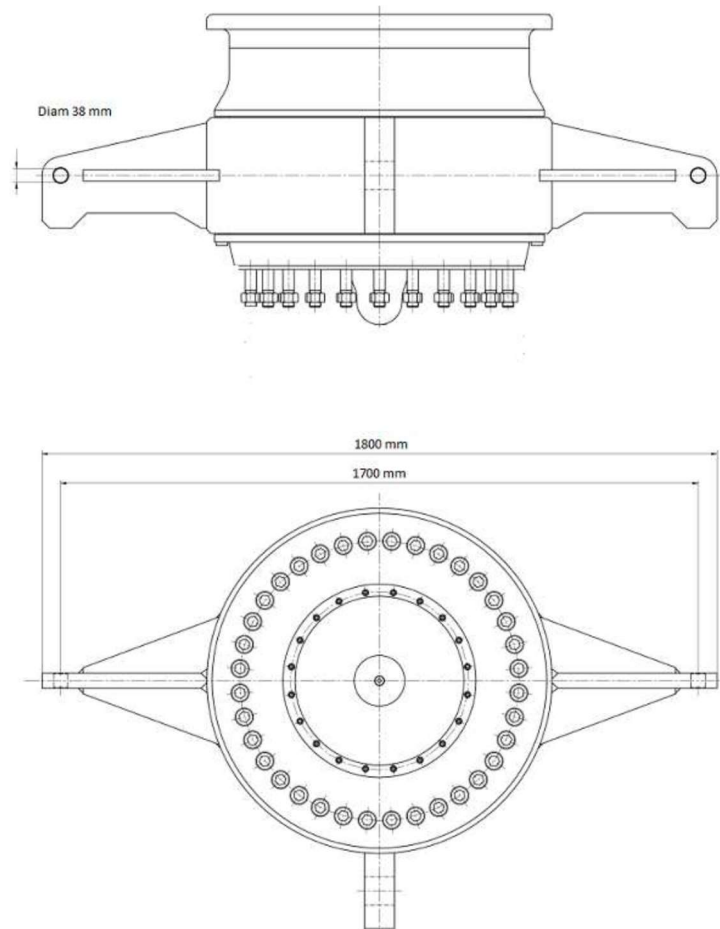

Figure 6-1 – NSV main characteristics.

- 6.9.5. PACKAGER shall provide two (02) flushing covers with hydraulic jacks to allow the opening of the hose termination piece, the proper flushing and pressure test of the hose string line.
- 6.9.6. The valve shall be designed to operate in an offshore environment CX according to ISO12944-1 and eventual Im1 environment. The collar shall receive an anticorrosive coating.
- 6.9.7. Materials specification for the NSV shall be carried out based on inlet fluids characteristics. The material selection shall take in account the maximum contaminants and minimum pH considering upset conditions such as downtime in biogenic H<sub>2</sub>S water tanks control.
- CO<sub>2</sub> content: up to 5% mol (gas phase in equilibrium with water phase).
  - H<sub>2</sub>S content: up to 200 mg/L (water phase).
  - Chloride (Cl<sup>-</sup>): up to 170,000 ppm (water phase).
  - Minimum pH: 4.0 (water phase).

- NSV shall be in accordance with ISO 15156 for the lowest anticipated pH and the highest.
- H<sub>2</sub>S partial pressure.

6.9.8. NSV shall be in accordance with ISO 15156 for the lowest anticipated pH and the highest H<sub>2</sub>S partial pressure.

- Note: the permitted exclusions listed at Table 1 of ISO15156-1 are not applicable to this valve.

6.9.9. NSV shall be able to handle BETX, as applicable.

6.9.10. NSV shall also be able to handle seawater as a service fluid.

**6.10. DETACHABLE HOSE BRIDLE**

6.10.1. The hose bridle between the hose termination piece and the hose messenger line shall be connected to the hose messenger line using a shackle.

- Note: It is extremely important from a safety point of view, that when the outboard hose termination piece is connected to the BLS on the DPST, the hose bridle must be disconnected to the hose line.

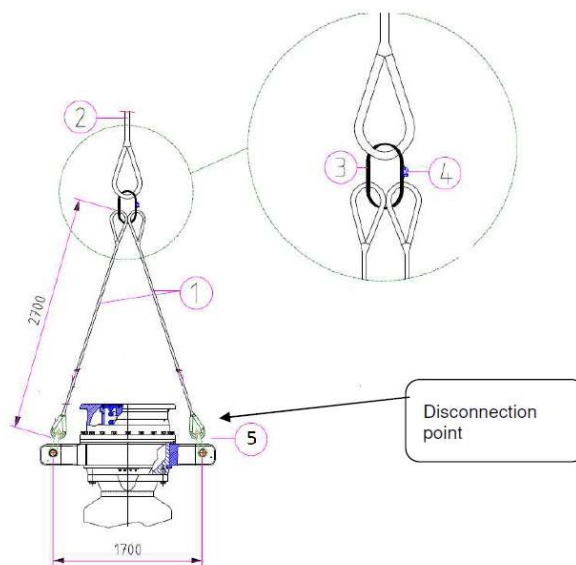



Figure 6-2 – Detachable Hose Bridle.

- 1) Fiber rope, HMPE, ISO 10325, type T (12-strand), RN 28, MBF 610 kN, with eye splices, one thimble in one splice
- 2) Fiber rope, HMPE, ISO 10325, type C (covered), (12-strand), RN 38, MBF 909 kN, with eye splices.
- 3) Fiber rope, HMPE, ISO 10325, type T (12-strand), RN 28, MBF 610 kN, with eye splices, length 1.5 m.

	TECHNICAL SPECIFICATION	Nr: I-ET-3010.2E-1359-940-P4X-001	REV. A
	-		SHEET: 28 of 34
	TITLE: OFFLOADING SYSTEM		INTERNAL
<p>4) Bow Shackle ABNT NBR 13545, grade 6, bolt type pin with hexagon head, hexagon nut and split cotter pin, WLL 5 t (Shackle ABNT NBR 13545-6-BX 5t).</p> <p>5) Bow Shackle ABNT NBR 13545, grade 6, bolt type pin with hexagon head, hexagon nut and split cotter pin, WLL 12.5/13.5 t (Shackle ABNT NBR 13545-6-BX 12.5/13.5 t).</p> <p><b>6.11. EMERGENCY OFFLOADING STATION/WINCH (GN-Z-1359502-04 / GN-Z-1359506-04) AND EMERGENCY OFFLOADING STRING</b></p> <p>6.11.1. One two (02) connection flange for each emergency station (bow and stern) shall be provided for emergency situations, which will be used to connect an Emergency Offloading hose string.</p> <p>6.11.2. The 1<sup>st</sup> hose section over the connection flange is a submersible hose without location collars. The 2<sup>nd</sup> and 3<sup>rd</sup> hose sections off the connection flange are submersible hoses with location collars and buoys or reinforced floating hoses. The remaining parts of the emergency hose string is similar to a regular 20" x 300# floating hose string.</p> <p>6.11.3. PETROBRAS shall supply the Emergency hose string whenever it is required.</p> <p>6.11.4. HULL SUPPLIER shall design and install only the standing part (piping, valves, controls) of the emergency offloading line (20", ANSI 300# class).</p> <p>6.11.5. HULL SUPPLIER shall provide all the necessary means and procedures at FPSO side to install the Emergency Hose String offshore (winches, sheaves, wire ropes, work platforms, slip way). On such procedures, special attention shall be given to safety of operators, which shall not be near or exposed to tensioned wires or ropes, or similar situations.</p> <p>6.11.6. The bow / stern emergency connection platforms shall be located in a position that provides adequate clearance for the offloading hose string from hull structures. Structures around this area shall be as smooth as possible, without any kind of sharp edges in order not to damage the hose.</p> <p>6.11.7. An oil spillage tray under the Emergency Offloading Assembly connection flange shall be provided, with means to convey residues to the Hull draining system.</p> <ul style="list-style-type: none"> <li>▪ Note: for vertical connection the means for oil contention shall be submitted to PETROBRAS for appraisal.</li> </ul> <p><b>6.12. AUXILIARY WINCH FOR HOSE MESSENGER / HAWSER MESSENGER (GN-Z-1359502-03 / Z-1359506-03)</b></p> <p>6.12.1. The UNIT shall be equipped with a hydraulically driven winch at each aft and fwd offloading station to launch, retrieve, spool and store the hose messenger line with pull in capacity of 20 t and minimum speed of 20 m/min.</p> <p>6.12.2. The drum of messenger line winch shall be able to work with both synthetic ropes and steel wire cable. The dimensions of this drum must be compatible to contain</p>			

	TECHNICAL SPECIFICATION	Nr: I-ET-3010.2E-1359-940-P4X-001	REV. A
	-		SHEET: 29 of 34
	TITLE: OFFLOADING SYSTEM		INTERNAL

up to 400 m of synthetic ropes of 96 mm diameter.

6.12.3. A 20 t SWL padeye shall be installed on deck, between hose messenger line winch and hose reel. This padeye shall be aligned to goose neck and be welded near messenger line winch structure base.

6.12.4. This winch shall have a minimum capacity to perform the offloading hose string pull-in / pull-out and must be aligned with the cargo flange of hose reel for this purpose. There should be no obstacles between winch and hose reel.

6.12.5. The AUXILIARY WINCH FOR HOSE MESSENGER / HAWSER MESSENGER (GN-Z-1359502-03 / GN-Z-1359506-03) shall be provided with an auxiliary drum for handling (reel or pay) small diameter cables (1" and lesser) to/from shuttle tanker. Please see picture below as a reference:

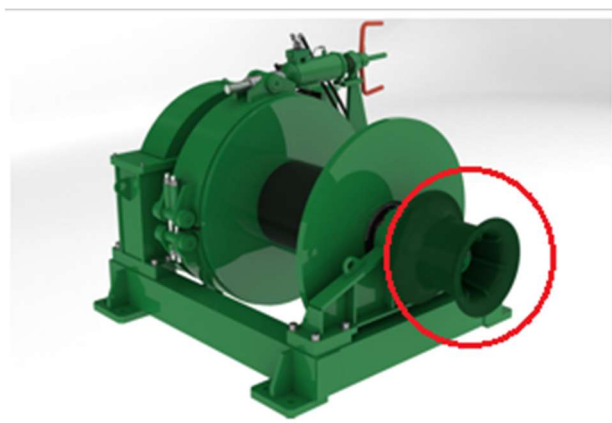



Fig. 6.12.5 – Auxiliary Winch auxiliary drums.

## 7. GENERAL REQUIREMENTS

### 7.1. ELECTRICAL REQUIREMENTS

7.1.1. PACKAGE electrical equipment, material, low voltage induction motors, and grounding installation shall comply with the following references:

- f) I-ET-3010.00-5140-700-P4X-001 – SPECIFICATION FOR ELECTRICAL DESIGN FOR OFFSHORE UNITS.
- a) I-ET-3010.00-5140-700-P4X-002 – SPECIFICATION FOR ELECTRICAL MATERIAL AND EQUIPMENT FOR OFFSHORE UNITS.
- b) I-ET-3010.00-5140-700-P4X-003 – ELECTRICAL REQUIREMENTS FOR PACKAGES FOR OFFSHORE UNITS.
- c) I-ET-3010.00-5140-712-P4X-001 – LOW-VOLTAGE INDUCTION MOTORS FOR OFFSHORE UNITS.
- d) I-DE-3010.00-5140-700-P4X-003 – GROUNDING INSTALLATION TYPICAL DETAILS.

	TECHNICAL SPECIFICATION	Nr: I-ET-3010.2E-1359-940-P4X-001	REV. A
	-		SHEET: 30 of 34
	TITLE: OFFLOADING SYSTEM		INTERNAL

## 7.2. INSTRUMENTATION AND AUTOMATION REQUIREMENTS

7.2.1. PACKAGE criteria for instrumentation, automation, interface and control design shall follow the below technical specifications:

- a) I-ET-3010.00-1200-800-P4X-002 – AUTOMATION, CONTROL AND INSTRUMENTATION ON PACKAGE UNITS.
- b) I-ET-3010.00-1200-800-P4X-013 – GENERAL CRITERIA FOR INSTRUMENTATION PROJECTS.
- c) I-ET-AUTOMATION INTERFACE OF PACKAGE UNITS.
- d) I-ET-3010.00-5520-888-P4X-001 – AUTOMATION PANELS.

## 7.3. PAINTING REQUIREMENTS

7.3.1. PACKAGE painting and coating shall be performed in accordance with I-ET-3010.00-1200-956-P4X-002 – GENERAL PAINTING and DR-ENGP-I-1.15 COLOR CODING.

7.3.2. All components shall be delivered fully painted/coated, unless otherwise indicated on this specification.

7.3.3. The performed pre-treatment and complete coating shall be in accordance with the paint manufacturer's data sheets.

## 7.4. NAMEPLATES AND TAG NUMBERING

7.4.1. PACKAGER / MANUFACTURER Equipment shall have nameplates in Brazilian Portuguese language, made of stainless steel AISI 316L, with 3 mm minimum thickness and fixed by stainless steel (AISI 316L) bolts or fasteners on visible and accessible location.

- Note 1: additional nameplates shall be provided as per NR13 rules if applicable.
- Note 2: for further requirements refer to EXHIBIT V – DIRECTIVES FOR PROCUREMENT.

7.4.2. Tagging of all instruments, electrical, mechanical and piping items, including valves, shall be carried out as detailed on I-ET-3000.00-1200-940-P4X-001 – TAGGING PROCEDURE FOR PRODUCTION UNITS DESIGN.

## 8. PACKAGE MANUFACTURING AND DELIVERY REQUIREMENTS

### 8.1. GENERAL

8.1.1. All materials and equipment supplied by PACKAGER / MANUFACTURER shall be brand new (not overhauled), field proven, free from defects and accepted by Owner and the Classification Society.

	TECHNICAL SPECIFICATION	Nr: I-ET-3010.2E-1359-940-P4X-001	REV. A
	-		SHEET: 31 of 34
	TITLE: OFFLOADING SYSTEM		INTERNAL

8.1.2. Materials and equipment shall be manufactured according to internationally recognized standards for the offshore oil drilling and production industries and shall be in conformance with the REFERENCE HULL 01 basic design related specifications and requirements.

8.1.3. Field proven definition as EXHIBIT V – DIRECTIVES FOR PROCUREMENT: systems and equipment shall demonstrate satisfactory operation at least in 3 floating offshore installation units, operating under process conditions (pressure, flow, capacity and similar fluids) for a minimum of 24,000 hours. For rotating equipment, they must demonstrate operation with fluid, flow and discharge pressure similar to the design. Unproven designs or prototypes (including components) without offshore service will not be accepted.

## 8.2. WELDING

8.2.1. PACKAGE equipment, structures and piping welding, welding inspection, non-destructive testing (NDT), bolted joints assembly and piping fabrication and commissioning activities shall be performed in compliance with the following technical specifications:

- a) I-ET-3010.00-1000-970-P4X-002 – Requirements for NDT.
- b) I-ET-3010.00-1000-955-P4X-002 – Requirements for Welding Inspection.
- c) I-ET-3010.00-1000-955-P4X-001 – Welding.
- d) I-ET-3010.00-1200-200-P4X-001 – Requirements for Bolted Joints Assembly and Management.
- e) I-ET-3010.00-1200-200-P4X-115 – Requirements for Piping Fabrication and Commissioning.

## 8.3. DOCUMENTATION

8.3.1. For the PACKAGE documentation and data-book requirements refer to EXHIBIT III – DIRECTIVES FOR ENGINEERING and to EXHIBIT V – DIRECTIVES FOR PROCUREMENT.

8.3.2. Instruction Manuals and technical documents shall have all instructions related to the operation, maintenance, inspection of the Offloading System should be detailed in a specific manual in order to ensure that they will be performed in safe and suitable manner. The following information should be available in the Offloading System Manuals:

- Offloading System General Arrangement.
- Installation Procedures.
- As-built drawings of all steel construction parts and main hydraulic diagrams.



	<b>TECHNICAL SPECIFICATION</b>	Nr: <b>I-ET-3010.2E-1359-940-P4X-001</b>	REV. <b>A</b>
	-		SHEET: 32 of 34
	TITLE: <b>OFFLOADING SYSTEM</b>		INTERNAL
<ul style="list-style-type: none"> <li>▪ Technical specification, drawings and functional description of all parts.</li> <li>▪ Weight Control Report.</li> <li>▪ Detailed periodic maintenance instructions.</li> <li>▪ Detailed maintenance instructions for the operational situations.</li> <li>▪ Regular inspections, calibrations, tests (including pressure tests) and checks (including the related data sheets, tables and charts).</li> <li>▪ Checklists and procedures for all the operational modes.</li> <li>▪ Instructions for emergency situations.</li> <li>▪ Procedures for replacement of the hawser and the hose sections.</li> <li>▪ Factory Acceptance Tests (FAT) for the main components.</li> <li>▪ Fabrication certificates, including the hoses.</li> <li>▪ Tests/Inspections Report (Test Certificates, Visual inspections, Welding inspection, Non-destructive Testing).</li> </ul> <p><b>8.4. SPARE PARTS</b></p> <p>8.4.1. For the PACKAGE, spare parts, special tools, CS required spare parts and spare parts list recommended for two (2) years of operation refer to EXHIBIT V – DIRECTIVES FOR PROCUREMENT.</p> <p><b>8.5. PRESERVATION, PACKING AND TRANSPORTATION</b></p> <p>8.5.1. For PACKAGE preservation, packing and transportation requirements refer to EXHIBIT V – DIRECTIVES FOR PROCUREMENT.</p> <p><b>9. INSPECTION AND TESTS</b></p> <p>9.1.1. For PACKAGE inspection, tests, factory acceptance test (FAT) and inspection release certificate (IRC), refer to EXHIBIT V – DIRECTIVES FOR PROCUREMENT.</p> <p>9.1.2. For PACKAGE inspection and test plan (ITP) requirements refer to EXHIBIT VII – DIRECTIVES FOR QUALITY ASSURANCE SYSTEM.</p> <p>9.1.3. Offloading System test requirements, which include the minimum requirements for the PACKAGE tests, are detailed on I-MD– COMMISSIONING DESCRIPTIVE MEMORANDUM.</p> <p><b>9.2. PRESSURE TEST OF HOSES AND PIPING ON REEL</b></p> <p>9.2.1. Offloading system, comprising the whole piping, swivel and hose string shall have</p>			





PETROBRAS

TECHNICAL SPECIFICATION

Nr: I-ET-3010.2E-1359-940-P4X-001

REV. A

SHEET: 33 of 34

TITLE: OFFLOADING SYSTEM

INTERNAL

ESUP

the pressure test with 300 psi for a minimum of six (06) hours.

9.2.2. The offloading hose string shall be paid out and reeled in, according to OCIMF – Handling, Storage, Inspection and Testing Hose Reels.

9.2.3. During the test, a visual inspection shall be carried out in order to detect any leakages or deformations.

## 10. ANNEX I – OFFLOADING OPERATIONAL DATA AND REQUIREMENTS

### 10.1. OFFLOADING OPERATIONAL SECTOR

10.1.1. The design and installation of the hose reel and hawser line must ensure the safety and efficiency of the offloading operations between the F(P)SO and the DPST throughout the entire operating sector described below.

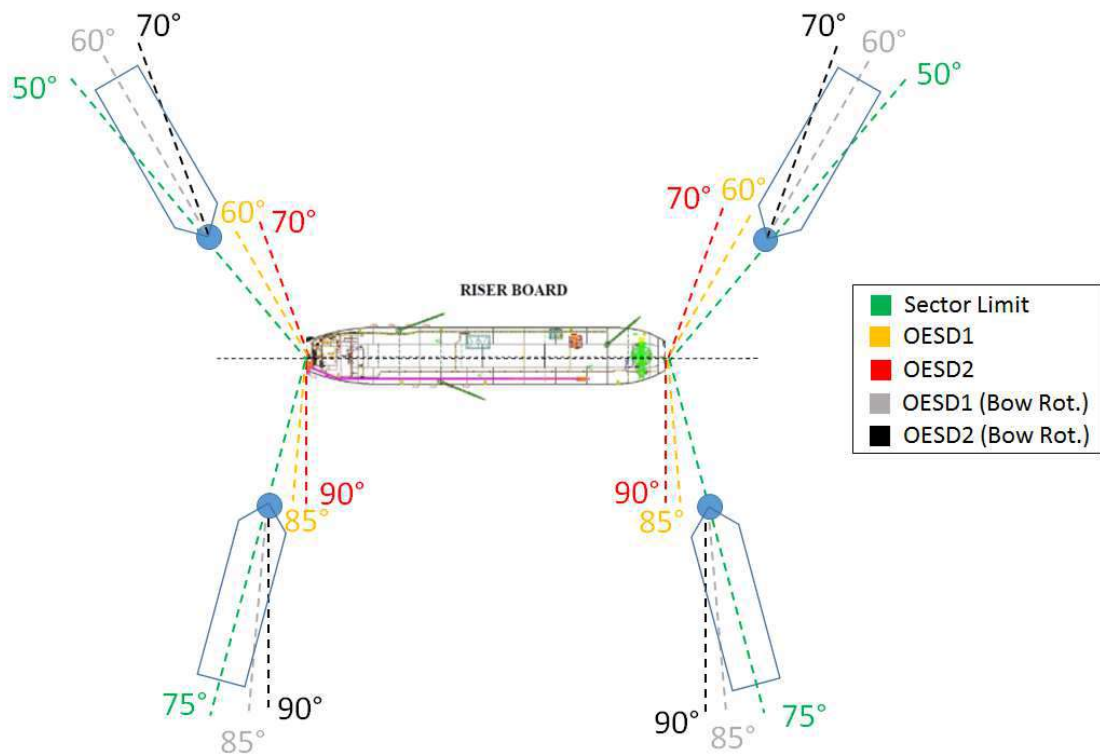

Figure 10-1 – Spread Mooring FPSO.



PETROBRAS

TECHNICAL SPECIFICATION

Nr:

I-ET-3010.2E-1359-940-P4X-001

REV.

A

SHEET: 34 of 34

TITLE:

OFFLOADING SYSTEM

INTERNAL

ESUP

10.1.2. Distance between F(P)SO and DPST and hawser and tension limitations during offloading.

RELATIVE DISTANCE DPST x FPSO (DP and Relative PRS)	HAWSER TENSION (tons)	ACTIONS
90 m OR LESS	---	RED ALARM NEAR ACTUATE "OESD-2" (Release Hose on BLS) RELEASE HAWSER
90 < L < 100 m	---	YELLOW ALARM NEAR STOP PUMPING ACTUATE "OESD-1" (Close Valves on BLS)
100 < L < 110 m	---	CONTACT FPSO PREPARE TO STOP PUMPING
110 < L < 120 m	---	PROXIMITY WARNING STAY ALERT
120 m	---	LOWER LIMIT FOR OFFLOADING
145 to 155 m	< 5 ton	NORMAL OFFLOADING
165 m	30 < T < 60 ton	STAY ALERT
	60 < T < 100 ton	CONTACT FPSO PREPARE TO STOP PUMPING
MORE THAN 170 m	T = 3 x 100 tons peaks per hour	YELLOW ALARM FAR STOP PUMPING ACTUATE "OESD-1" (Close Valves on BLS)
	TENSION OVER 100 ton	RED ALARM FAR ACTUATE "OESD-2" MANUALLY AND DISCONNECT HAWSER

Figure 10-2 – relative distance DPST x FPSO

## 10.2. ABSOLUTE, RELATIVE POSITIONING REFERENCE AND TELEMETRY SYSTEM

10.2.1. For the Absolute, Relative Positioning Reference and Telemetry System refer to I-ET-3010.00-5537-76F-PPT-001 – POSITIONING REFERENCE SYSTEMS FOR OFFSHORE LOADING SYSTEM.