

| | | |
|---|-------------------------------------|--|
|  | TECHNICAL SPECIFICATION | Nº: I-ET-3010.00-5516-764-PPT-001 |
| | CLIENT: SRGE | SHEET: 1 of 25 |
| | JOB: TELECOMMUNICATION VOICE | |
| | AREA: - | |
| TIC | TITLE: HULL TELEPHONY SYSTEM | INTERNAL |
| | | OI/CS |

MICROSOFT WORD / V.2016 / I-ET-3010.00-5516-764-PPT-001_A.docx

INDEX OF REVISIONS

| REV. | DESCRIPTION AND/OR REVISED SHEETS |
|------|-----------------------------------|
| 0 | ORIGINAL ISSUE |
| A | REVISED WHERE INDICATED |

| | REV. 0 | REV. A | REV. B | REV. C | REV. D | REV. E | REV. F | REV. G | REV. H |
|-----------|-----------|-------------|--------|--------|--------|--------|--------|--------|--------|
| DATE | APR/08/22 | OCT/25/2022 | | | | | | | |
| DESIGN | PROJ-US | PROJ-US | | | | | | | |
| EXECUTION | Y3S7 | Y3S7 | | | | | | | |
| CHECK | CY22 | CY22 | | | | | | | |
| APPROVAL | X187 | X187 | | | | | | | |

INFORMATION IN THIS DOCUMENT IS PROPERTY OF PETROBRAS, BEING PROHIBITED OUTSIDE OF THEIR PURPOSE

FORM OWNED TO PETROBRAS N-0381 REV. L



| | | |
|-------------------------------------|--|---------------|
| TECHNICAL SPECIFICATION | Nº: I-ET-3010.00-5516-764-PPT-001 | REV. A |
| AREA: - | SHEET: 2 of 25 | |
| TITLE: HULL TELEPHONY SYSTEM | INTERNAL | |
| | O/CS | |

INDEX

| | | |
|----|---|----|
| 1. | SUBJECT..... | 3 |
| 2. | ABBREVIATIONS..... | 3 |
| 3. | REFERENCE DOCUMENTS, CODES AND STANDARDS..... | 4 |
| 4. | GENERAL REQUIREMENTS..... | 6 |
| 5. | SYSTEM DEFINITIONS..... | 9 |
| 6. | TECHNICAL REQUIREMENTS..... | 18 |
| 7. | SCOPE OF SUPPLY..... | 21 |
| 8. | DIMENSIONING CRITERIA..... | 23 |
| 9. | COMMISSIONING..... | 24 |

| | | | |
|---|--------------------------------|--|----------------|
|  | TECHNICAL SPECIFICATION | Nº: I-ET-3010.00-5516-764-PPT-001 | REV. A |
| | AREA: | - | SHEET: 3 of 25 |
| | TITLE: | HULL TELEPHONY SYSTEM | |
| | | | OI/CS |

1. SUBJECT

- 1.1 The subject of this document is to establish the criteria and basic characteristics for the detailed design, supply, installation and configuration of HULL TELEPHONY SYSTEM that shall be installed in PETROBRAS FPSO Unit, to provide telephonic communication.
- 1.2 HULL TELEPHONY SYSTEM shall enable internal voice communications all over the FPSO Unit and between the FPSO Unit and PETROBRAS Operational Base.

2. ABBREVIATIONS

| | |
|---------|---|
| ABNT | Brazilian Association of Technical Standards (Associação Brasileira de Normas Técnicas) |
| AC | Alternating Current |
| ANATEL | Brazilian Telecommunication Authority (Agência Nacional de Telecomunicações) |
| ANSI | American National Standards Institute |
| ART | Technical Responsibility Note (Anotação de Responsabilidade Técnica) |
| ASTM | American Society for Testing and Materials, |
| AWG | American Wire Gauge |
| BLT | Buzzer and Lamp accoupled for Telephony |
| BUZ | Buzzer |
| CCR | Central Control Room |
| CDT | Telephone Distribution Box |
| CJT | Telephone Junction Box |
| CMP | External bells |
| DC | Direct Current |
| DGT | General Telephone Distributor |
| DIO | Optical Distribution Drawer |
| EIA | Electronic Industries Alliance |
| EPR | Eethyl-Propylene Rubber |
| FPSO | Floating, Production, Storage and Offloading |
| GMDSS | Global Maritime Distress Safety System |
| GPS | Global Positioning System |
| ICA | Aeronautical Cartography Institute (Instituto de Cartografia Aeronáutica) |
| IEC | International Electrotechnical Commission |
| IEEE | Institute of Electric and Electronic Engineers |
| INMETRO | National Institute of Metrology (Instituto Nacional de Metrologia) |
| IMO | International Maritime Organization |
| IP | Internet Protocol |
| IS | Intrinsic Safe |
| ITU | International Telecommunication Union |
| LAN | Local Area Network |

| | | | |
|---|--------------------------------|--|----------------|
|  | TECHNICAL SPECIFICATION | Nº: I-ET-3010.00-5516-764-PPT-001 | REV. A |
| | AREA: | - | SHEET: 4 of 25 |
| | TITLE: | HULL TELEPHONY SYSTEM | |
| | | | OI/CS |

| | |
|--------|--|
| LST | Telephone Signaling Lamp |
| LSZH | Low Smoke Zero Halogen |
| MDF | Main Distribution Frame |
| MODU | Mobile Offshore Drilling Unit |
| NORMAM | Standard of Maritime Authority (Normas da Autoridade Marítima) |
| NR | Regulatory Standard (Norma Regulamentadora) |
| OSI | Open Systems Interconnection |
| PABX | Private Automatic Branch eXchange |
| PDD | Data Distributor Panel |
| PLL | Phase Locked Loop |
| PoE | Power Over Ethernet |
| QSIG | Q signaling |
| RF | Radio Frequency |
| SIP | Session Initiation Protocol |
| TCP | Transmission Control Protocol |
| TDM | Time-division multiplexing |
| TIA | Telecommunications Industry Association |
| SOLAS | Safety Of Life At Sea |
| UPS | Uninterruptible Power Supply |
| UTP | Unshielded Twisted Pair |
| VAC | Volts Alternating Current |
| VDC | Volts Direct Current |
| VoIP | Voice over Internet Protocol |
| WAN | Wide Area Network |

3. REFERENCE DOCUMENTS, CODES AND STANDARDS

3.1 International Standards

- a. IEC 60079: Electrical apparatus for explosive gas atmospheres - all parts
- b. IEC 60092-502: Electrical installations on ships
- c. IEC 60331: Tests for electric cables under fire conditions - circuit integrity – all parts
- d. IEC 60529: Degrees of protection provided by enclosures (IP code)
- e. IEC 60533: Electrical and electronic installations in ships - electromagnetic compatibility
- f. IEC 60945: Maritime navigation and radiocommunication equipment and systems – general requirements – methods of testing and required test results

| | | | |
|---|--------------------------------|--|---------------|
|  | TECHNICAL SPECIFICATION | Nº: I-ET-3010.00-5516-764-PPT-001 | REV. A |
| | AREA: - | SHEET: 5 of 25 | |
| | TITLE: | HULL TELEPHONY SYSTEM | |
| | | INTERNAL | OI/CS |

- g. IEC 61000: Electromagnetic compatibility (EMC) series - all parts
- h. IEC 61892-7: Mobile and fixed offshore units - electrical installations - part 7: hazardous area
- i. IMO Harmonization of GMDSS Requirements for Radio Installations on Board SOLAS Ships.
- j. IMO LSA Code – International Life-Saving Appliance Code.
- k. IMO MODU Code - Code for the Construction and Equipment of Mobile Offshore Drilling Units.
- l. IMO Resolution A.1021 – Codes on Alerts and Indications.
- m. IMO Resolution A.801 – Provision of Radio Services for the Global Maritime Distress and Safety System.
- n. IMO Resolution A.888 – Criteria for the Provision of Mobile-Satellite Communication Systems in the Global Maritime Distress and Safety System (GMDSS).
- o. IMO SOLAS – International Convention for the Safety of Life at Sea.
- p. ISO 7240-19 – Fire Detection and Alarm Systems - Design, installation, commissioning and service of sound systems for emergency purposes.

3.2 Brazilian Standards

- a. INMETRO PORTARIA Nº 115 (21/março/2022): regulamento de avaliação da conformidade de equipamentos elétricos para atmosferas potencialmente explosivas, nas condições de gases e vapores inflamáveis e poeiras combustíveis.
- b. NR-10: Segurança em instalações e serviços em eletricidade.
- c. NR-30: Plataformas e instalações de apoio – anexo II.
- d. NR-37: Segurança e saúde em plataformas de petróleo.
- e. It shall be followed all others NR's – Normas Regulamentadoras (Regulatory Standards) from Ministério da Economia (Brazilian Ministry of Labor) applicable to this Technical Specification.
- f. ICA 63-10 – Estações Prestadoras de Serviços de Telecomunicações e Tráfego Aéreo.
- g. NORMAM 01/DPC – Normas da Autoridade Marítima para Embarcações Empregadas na Navegação em Mar Aberto.

| | | | |
|---|--------------------------------|--|---------------|
|  | TECHNICAL SPECIFICATION | Nº: I-ET-3010.00-5516-764-PPT-001 | REV. A |
| | AREA: - | SHEET: 6 of 25 | |
| | TITLE: | HULL TELEPHONY SYSTEM | |
| | | INTERNAL | OI/CS |

- h. NORMAM 27/DPC – Normas da Autoridade Marítima para Homologação de Helipontos Instalados em Embarcações e em Plataformas Marítimas.
- i. ANATEL – any applicable resolution from Agência Nacional de Telecomunicações

3.3 Classification Society

3.3.1. The detailed design shall be submitted to approval by Classification Society. The design and installation shall take into account their requirements and comments.

4. GENERAL REQUIREMENTS

- 4.1 CONTRACTOR shall provide all the materials to install all equipment, accessories, cables and infrastructure that compose the HULL TELEPHONY SYSTEM also referred as 2-way voice communication system by SOLAS.
- 4.2 The PABX of HULL TELEPHONY SYSTEM shall be installed in an appropriate rack in the Telecom Lower Room, located on Accommodation Module.
- 4.3 The power supply of this system is scope of technical specification document: I-ET-3010.00-5264-769-PPT-001 – HULL TELECOM ENERGY SYSTEM.
 - 4.3.1. The Telephony System shall be powered from (-) 48 VDC uninterruptible power supply for continuous operation in case of main power loss. The (-) 48 VDC shall be powered from the essential power system which shall be fed by emergency power generator. This one shall be able to keep the system for a period of, at least, 18 hours in stand-by and enough power to operate the system for, at least, 30 minutes.
- 4.4 For PETROBRAS detailed design requirements, installation, configuration, tests, training and commissioning CONTRACTOR shall comply with the Technical Specification I-ET-3010.00-5510-760-PPT-002 BASIC CRITERIA FOR TELECOM DESIGN.
- 4.5 For telecommunications symbols, the detailed design shall comply with the Technical Specification: I-ET-3000.00-0000-940-P4X-002 – SYMBOLS FOR PRODUCTION UNITS DESIGN.
- 4.6 For telecommunications TAGs, the detailed design shall comply with the Technical Specification: I-ET-3000.00-1200-940-P4X-001– TAGGING PROCEDURE FOR PRODUCTION UNITS DESIGN.
- 4.7 For telecommunications infrastructure materials, accessories, cable trays cable ladder, the Detailed Design shall comply with all electrical requirements for telecom package and it shall be in accordance with I-ET-3010.00-5140-700-P4X-003 – ELETRICAL REQUIREMENTS FOR PACKAGES FOR OFFSHORE, I-ET-

| | | | |
|---|--------------------------------|--|---------------|
|  | TECHNICAL SPECIFICATION | Nº: I-ET-3010.00-5516-764-PPT-001 | REV. A |
| | AREA: - | SHEET: 7 of 25 | |
| | TITLE: | HULL TELEPHONY SYSTEM | |

3010.00-5140-700-P4X-001 - SPECIFICATION FOR ELECTRICAL DESIGN FOR OFFSHORE UNITS, I-DE-3010.00-5140-700-P4X-003 - GROUNDING INSTALLATION TYPICAL DETAILS and I-ET-3010.00-5140-700-P4X-005 - REQUIREMENTS FOR HUMAN ENGINEERING DESIGN FOR ELECTRICAL SYSTEMS OF OFFSHORE UNITS.

- 4.8 The PABX of HULL TELEPHONY SYSTEM shall be installed and configured by the vendor representative with training and certificate in comply with the model supplied for the project, including the interconnection with PETROBRAS corporative telephony network.
- 4.8.1. These activities shall be foreseen to be done at the shipyard after the WAN network connection.
- 4.9 Equipment and accessories installed in outdoor or industrial areas shall be suitably rugged and their external bodies shall be made in non-metallic material, suitable for harsh environments and in accordance with IEC and ABNT standards, apart from the ones whose classification area require to be metallic as Ex-d junction boxes.
- 4.10 Brackets, bolts, nuts, washers and any other mechanical fixing elements shall be made in stainless steel.
- 4.11 In case of difficulty for supplying some accessory with external body made with non-metallic materials, it will be necessary to submit them for analysis and approval of PETROBRAS.
- 4.12 It shall be avoided equipment and accessories with their external bodies built in aluminum alloy. Anything different shall be submitted to PETROBRAS approval. In case of approval, this alloy shall not contain in its composition more than 0.25 % of copper and shall comply with the ASTM-B-179 standard (ANSI alloy 356.1).
- 4.13 In outdoor areas, exposed to marine atmosphere, CONTRACTOR shall avoid the galvanic corrosion of junction boxes supports, horns supports and bolts. Galvanic insulation shall be implemented wherever contact between different metallic materials is needed.
- 4.14 The equipment and accessories shall attend the ingress protection degree, protection type, classifications zone and groups established by IEC / ABNT.
- 4.15 CONTRACTOR shall supply only equipment, accessories, cables and materials homologated by National Telecommunication Agency (ANATEL), whenever required by Brazilian standards and laws.
- 4.16 CONTRACTOR shall supply the whole Telephony System and all equipment, cables, accessories with TYPE APPROVAL issued by Classifying Society and in technical conformity with the International and National standardization organism: ABNT, IEC and INMETRO.

| | | | |
|---|--------------------------------|--|-----------------|
|  | TECHNICAL SPECIFICATION | Nº: I-ET-3010.00-5516-764-PPT-001 | REV. A |
| | AREA: - | SHEET: 8 of 25 | |
| | TITLE: | HULL TELEPHONY SYSTEM | INTERNAL |
| | | | OI/CS |

- 4.17 The equipment and materials shall be supplied packed in suitable cases/box for long periods of storage and, also, be protected against mechanical impact and adverse weather conditions.
- 4.18 CONTRACTOR shall provide full integration and interoperability between the HULL TELEPHONY SYSTEM, and the Corporate Telephony System used by PETROBRAS. PETROBRAS will provide all parameters during the detailed design phase.
- 4.19 CONTRACTOR shall consider, at least, a 20% spare in cables, terminals block, box penetration holes and other items of the infrastructure of the hull Telephony System.
- 4.20 Electrical equipment installed in external (open) safe areas, foreseen to operating during emergency shutdown ESD-3 shall be certified for installation in hazardous areas Zone 2 Group IIA temperature T3, according to IEC 61892-1.
- 4.21 All cables conductors shall be terminated on needle terminals (Figure 1) or European Terminal Pin (Figure 2) to connect on SAK terminal blocks or similar.



Figure 1: Examples of needle terminals.



Figure 2: Examples of European Terminal Pins

- 4.22 The equipment and Telephone Distribution Boxes (CDTs) for industrial areas shall be built in such a manner that, after installation, the rear face is spaced away from the wall support.
- 4.23 All equipment of the Hull Telephony System, located in external and in industrial areas, shall be installed under conditions whereby there is always a floor below them so as to provide protection and easy access for servicing.
- 4.24 In order to avoid humidity and water ingress inside the junction boxes, CONTRACTOR shall apply appropriate material, according to IEC standards, in the screw thread, bolts, cable glands, cover plugs and joints.
- 4.25 The Telephone distribution boxes (CDTs) shall have the cable glands installed facing lateral sides and/or bottom side. Cable glands installed facing upward are not acceptable. It is also not acceptable any opening facing the upward of the box, even if it is closed by cover plug.

| | | | |
|---|--------------------------------|--|---------------|
|  | TECHNICAL SPECIFICATION | Nº: I-ET-3010.00-5516-764-PPT-001 | REV. A |
| | AREA: - | SHEET: 9 of 25 | |
| | TITLE: | HULL TELEPHONY SYSTEM | |

- 4.26 The booths for the Telephony System shall be in different color than the booths for PAGA System and it shall be identified with a visible plate written in Brazilian Portuguese as a Telephone equipment of Telephony System.
- 4.27 In each diving areas shall be foreseen the installation of a Telephone Distribution Box (CDT) in order to prepare to connect the PAGA systems to the Diving Container.
- 4.28 CONTRACTOR shall ensure by inspection of a qualified personnel that all equipment installations are according to the IEC/ABNT standards requested in this technical specification.
- 4.29 IP telephones shall be installed in the cabling described in the I-ET-3010.00-5517-768-PPT-002 - HULL STRUCTURED CABLING NETWORK.

5. SYSTEM DEFINITIONS

5.1 Private Automatic Branch eXchange (PABX)

- a. Manufacture: Unify
- b. Model: OpenScape 4000 V8 or superior:

5.1.1. Main Characteristic and Facilities

- a. Hybrid TDM/IP-PBX
- b. Native SIP-based real-time Voice over IP;
- c. Distributing Access Points, via an IP network;
- d. SIP SERVER facilities;

5.1.2. Network connectivity

- a. SIP trunking to service providers;
- b. SIP Private Networking;
- c. QSIG networking;
- d. Call Admission Control features;
- e. Supported gateways.

5.1.3. SIP signaling features

- a. Integration with OpenScape Xpressions;
- b. Interworking with OpenScape SBC;
- c. Interworking with SIP service providers;
- d. Interworking with unified messaging systems;
- e. Interworking with voice mail systems;
- f. SIP over TCP/TLS support;
- g. SIP privacy mechanism;

| | | | |
|---|--------------------------------|--|---------------|
|  | TECHNICAL SPECIFICATION | Nº: I-ET-3010.00-5516-764-PPT-001 | REV. A |
| | AREA: - | SHEET: 10 of 25 | |
| | TITLE: | HULL TELEPHONY SYSTEM | |
| | | INTERNAL | OI/CS |

5.1.4. Features/Facilities

- a. Administrator identification and authentication;
- b. Backup and restore;
- c. Call timing;
- d. Basic traffic tool;
- e. Call trace;
- f. Continuous trace;
- g. Database versioning;
- h. Log file retrieval tool;
- i. Maintenance manager;
- j. Mass provisioning;
- k. On-demand audits;
- l. Process debug tool;
- m. Query of subscriber transient operational status;
- n. RapidStat;
- o. Real-time trace;
- p. Remote patching;
- q. Remote restart;
- r. Software installation;
- s. System software and patch level status;
- t. System upgrade.

5.1.5. Workgroup features

- a. Call pickup:
 - i. Group;
 - ii. Directed.
- b. Call Park:
 - i. Park to System.

5.1.6. CDR features

- a. Call detail record generation;
- b. Intermediate long duration records;
- c. Message detail recording;
- d. Usage reporting.

5.1.7. Categories of licenses

- a. TDM licenses:
 - i. Analog devices;
 - ii. ISDN devices.
- b. Flex licenses:
 - i. Used for all devices;
 - ii. IP-based devices.

5.1.8. Power supply voltage

- a. DC: -48V (Main and secondary power supply);
- b. Hot swap plug shall be supported.

| | | | |
|---|--------------------------------|--|---------------|
|  | TECHNICAL SPECIFICATION | Nº: I-ET-3010.00-5516-764-PPT-001 | REV. A |
| | AREA: - | SHEET: 11 of 25 | |
| | TITLE: | HULL TELEPHONY SYSTEM | |
| | | INTERNAL | OI/CS |

- c. DC power supply voltage operational range shall be according to volt drop criteria stated on I-ET-3010.00-5264-769-PPT-001 HULL TELECOM ENERGY SYSTEM.

5.1.9. Failover facility / Redundancy

- a. Redundant Central control board (controller board);
- b. Redundant power supplies (AC/DC, mixed also);
- c. Redundant LAN interface;
- d. Redundant SSD drives (RAID 1);
- e. Redundant WAN interface;
- f. Redundant fan trays.

5.1.10. VoIP gateways

- a. SIP-Q trunking;
- b. Native SIP subscriber interface for SIP applications;
- c. Native SIP trunking;
- d. Flexible SIP connectivity;
- e. IP connectivity resilience with redundant LAN interfaces;
- f. T.38 fax transmissions for SIP subscribers;
- g. SIP trunking;
- h. IP connectivity between IP branches;
- i. G.729 voice compression.

5.2 Telephony Interface Box – Hull external areas and Topside Modules

- 5.2.1. It shall be foreseen an interface Telephone Distribution Box (CDT) and its own enclosure shall be made on, at least, ingress protection rating IP-67 and it shall be located on the external area of the accommodation module, in a place that will be defined during the detailed design.
- 5.2.2. This CDT shall be interconnected to DGT/MDF installed in Telecom CCR Room, using 02 (two) armored telephone cables, each of them with 24 (twenty-four) pairs of 0.75 mm², from the DGT/MDF.
- 5.2.3. At the CDT, for Telephone System interface with DGT/MDF on the Telecom CCR Room, and telephones in external areas, all Terminals Blocks connectors and terminals shall be SAK type terminal or similar.
- 5.2.4. At DGT/MDF installed in Telecom CCR Room all Terminals Blocks connectors and terminals for interface with the PABX shall be type 110 IDC with surge protector block termination or M-10 with surge protector block termination or similar.
- 5.2.5. At DGT/MDF installed in Telecom CCR Room all Terminals Blocks connectors and terminals for interface with the CDT shall be SAK type terminal or similar.

d. 20 (twenty) holes for cable of 02 pairs and stopper plug, in accordance with environment and standards applicable.

5.2.7. CONTRACTOR shall consider as reference the following drawing as a final configuration for interface box, once the final configuration shall be done during detailed design.

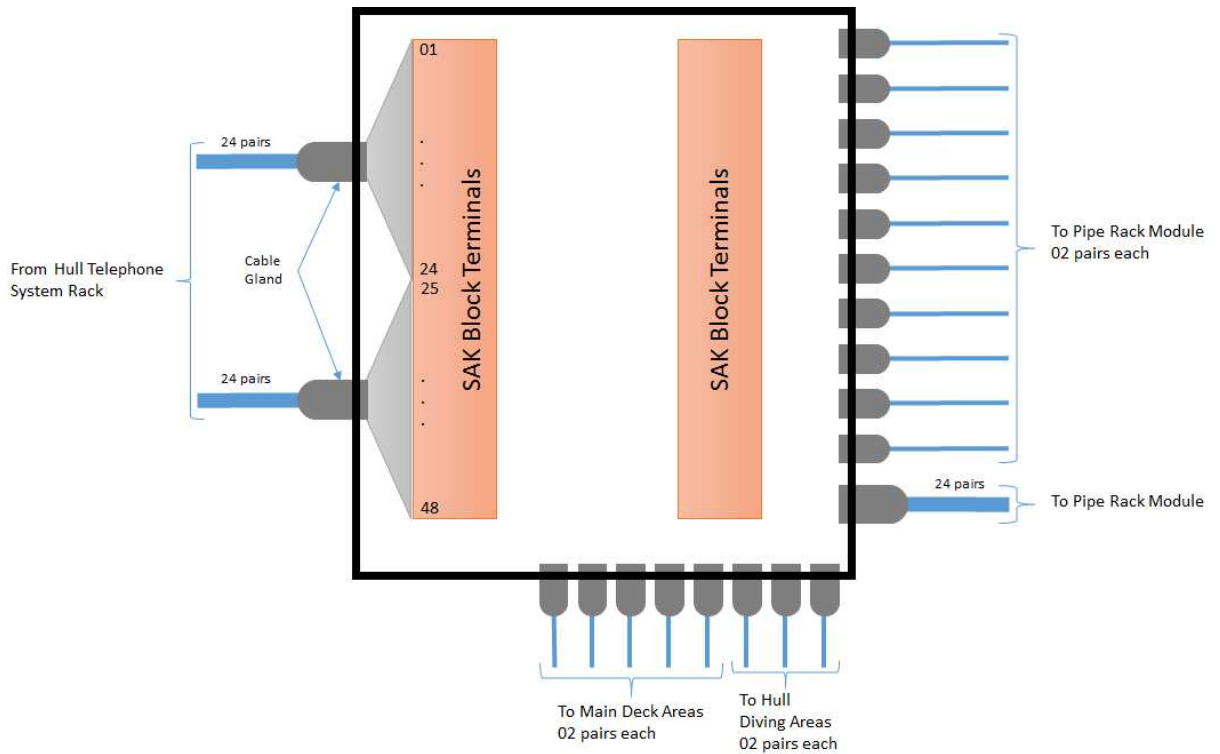

Figure 6: Configuration for Interface Box for TOPSIDE TELEPHONE NETWORK connections.

5.3 Acoustic Hood and Acoustic Booth

5.3.1. It shall be used at very noisy places and it shall have a type of shield that fits around it, with weather-proof and explosion-proof telephone set (TEL), which reduces the noise generated when that equipment is being used. Built of fiberglass or injected ABS plastic.

5.3.2. For use in areas with surrounding noise level higher than 80 dB.

5.3.3. CONTRACTOR shall provide and install support structure and assembly plate for telephone with respective distribution box mounted outside the cabin.

5.4 In closed areas protected by any gas for fire extinguishing (like CO₂, inergen, etc), only acoustic hoods (half-body) shall be used and with noise level higher than 80 dB a headset shall be provided. In such areas, it shall be provided gas singling lamp as per Safety requirements.

5.4.1. All other acoustic booth required shall be full size with proper illumination inside.

| | | | |
|---|--------------------------------|--|-----------------|
|  | TECHNICAL SPECIFICATION | Nº: I-ET-3010.00-5516-764-PPT-001 | REV. A |
| | AREA: - | SHEET: 14 of 25 | |
| | TITLE: | HULL TELEPHONY SYSTEM | |
| | | | INTERNAL |
| | | | OI/CS |

5.5 Terminal Block

- 5.5.1. Blocks for connecting electrical conductors of telephone networks, installed in DGT, CDT's and CJT's.
- 5.5.2. Terminal Blocks (BT's) shall be arranged to facilitate differentiation between the circuits from different networks.

5.6 Telephone Distribution Box (CDT)

- 5.6.1. Telephone Distribution Box is the intermediate or peripheral box or switchboard for distribution of telephony sub-networks.
- 5.6.2. Telephone Distribution Box shall be used for connecting cables of the telephone system.
- 5.6.3. It shall be built of non-metallic materials like polycarbonate, anti-static polyamide, ABS plastic, fiberglass and others.

5.7 Telephone Junction Box (CJT)

- 5.7.1. Peripheral box used for splicing and shunting of telephony networks, limited to hook-up of 04 (four) cables.

5.8 General Telephone Distributor (DGT) / Main Distribution Frame (MDF)

- 5.8.1. It shall be installed in the Telecom Lower Room in C Deck to interconnect the analogical and industrial telephone network on 110 IDC protector block termination or M-1 protector block termination or similar.
- 5.8.2. The General Telephone Distributor dimension shall be defined in the detailed design, with blocks as described below:
 - 5.8.2.1. Vertical bars for assembly of SAK blocks (DGT vertical block) and vertical bars for assembly 110 IDC protector block termination or M-10 protector block termination or similar (DGT horizontal block), type quick connection technique with individual protection, for use with the connection to PDD (data distributor panel) from structured cabling network.

5.9 Cable-Clamps

- 5.9.1. Devices used for mechanical attachment of the electrical cables to the distribution boxes or panels providing the use of such units.

| | | | |
|---|---|--|-----------------|
|  | TECHNICAL SPECIFICATION | Nº: I-ET-3010.00-5516-764-PPT-001 | REV. A |
| | AREA: - | SHEET: 15 of 25 | |
| | TITLE: <p style="text-align: center;">HULL TELEPHONY SYSTEM</p> | | INTERNAL |
| | | | OI/CS |

5.9.2. All cable-clamps shall be designed, manufactured and tested in accordance with the applicable existing requirements. For selection of the cable-clamps used on the different types of cables, according to their dimensions and features of its internal and external layers.

5.9.3. The cable-clamps shall not be manufactured in cast aluminum and/or nylon.

5.10 Telephone Signaling Lamp (LST)

5.10.1. According to IMO Resolution A.1021 – Codes on Alerts and Indications, table 7.1.3 – Call Signals, Telephone Color Signals shall be White/Clear.

5.10.2. White color lamps, strobe or flashing light, at least, 10 Watts/10 Joules of power or 300 Cd (Candela)/300 lx (Lux) @ 1 m, which is better, for use with acoustic booth or acoustic hood in areas where the surrounding noise level exceeds 80 dB.

5.11 Buzzer (BUZ)

5.11.1. It shall be used with acoustic booth or acoustic hood in areas where the surrounding noise level exceeds 80 dB.

5.11.2. The telephone signaling lamp and the electric buzzer mounted on the same equipment shall be preferential and shall be tagged as BLT.

5.11.3. The buzzer ringtone of such BLT shall have a different sound than the PAGA emergency alarm sound, so that there is no possibility of these two sounds being confused.

5.11.4. Each BLTs shall be powered by dedicated circuit breaker from a dedicated electrical panel with spares.

5.12 Telephone Cables

5.12.1. The cables shall contain an insulation cover made in ethyl-propylene rubber (EPR) for use in free and industrial areas, as well as internal cables and in panels.

5.12.2. The cables in all lodging areas shall contain an insulation cover made in halogen-free rubber, with proper thermal characteristics, ozone and corona effect resistant, in addition to withstanding the following thermal conditions:

- a. A maximum of 85°C in continuous operations (damp or dry places);
- b. 130°C under emergency over-load conditions;
- c. 200°C under short-circuit conditions;
- d. All cables shall be low voltage type (250 Volts AC)

5.12.3. External Identification

| | | | |
|---|--------------------------------|--|---------------|
|  | TECHNICAL SPECIFICATION | Nº: I-ET-3010.00-5516-764-PPT-001 | REV. A |
| | AREA: - | SHEET: 16 of 25 | |
| | TITLE: | HULL TELEPHONY SYSTEM | |
| | | INTERNAL | OI/CS |

5.12.3.1. All cables shall be identified on the outside along their length (at maximum intervals of 2.0 m), by the following information:

- a. Type of cable;
- b. Formation of conductors;
- c. Sectional area of conductors in mm²;
- d. Name of manufacturers;
- e. Commercial reference of manufacturers.

5.12.3.2. Each item of cable shall be supplied in reels or on spools, in continuous runs, with the length established in the purchase documentation;

5.12.3.3. Each spool or reel shall be identified on the outside by the number of the purchase document, total length of purchase, total length of run, gauge in mm², make-up of cable and any other data called for in the purchase documentation.

5.12.4. Other requirements in according with Classifying Society

5.12.4.1. Cables for circuits that shall operate under fire conditions and cables crossing machinery space category A, as defined by SOLAS, shall be certified for circuit integrity under fire conditions, according to IEC60331. CONTRACTOR shall attend this need without costs to PETROBRAS.

5.12.4.2. The Classifying Society shall supply one list with the places or one document of rules to be followed by the contractor, where these requirements shall be informed.

5.12.4.3. CONTRACTOR shall submit the detailed design with the cables list for approval by the PETROBRAS and Classifying Society.

5.13 Telephone Set (TEL)

5.13.1. Non-Hazardous Areas

5.13.1.1. Environments with artificial ventilation (offices cabins and recreation areas):

- a. IP Telephone set, OpenScape Desk Phone CP 200 SIP, OpenScape Desk Phone CP600 SIP, or better, made by Unify.
- b. Connectors shall be RJ-45 type.
- c. All IP Phones shall be powered by PoE.

| | | | |
|---|--------------------------------|--|---------------|
|  | TECHNICAL SPECIFICATION | Nº: I-ET-3010.00-5516-764-PPT-001 | REV. A |
| | AREA: - | SHEET: 17 of 25 | |
| | TITLE: | HULL TELEPHONY SYSTEM | |

5.13.1.2. In addition, it shall be installed in Telecom Upper Room, Telecom Lower Room, CCR Automation & TBM Room, Infirmary, Safety Room, Coordinators Room and OIM (GEPLAT) Office the following wireless telephone set:

- a. IP Wireless Telephone Set, model Wireless Phone Cisco 8821-EX SIP or other compatible model with Unify solution approved by PETROBRAS during the detailed design.

5.13.1.3. Environments with natural ventilation (non-offices areas):

- a. Push-button wall type automatic TEL, shall be used with protection suitable for the prevailing environmental conditions.
- b. Depending on the noise level of the environment, it shall be used accessories such as Integrate Buzzer and Signaling Lamp (BLT).

5.13.2. Hazardous Areas

- a. Push-button wall type automatic TEL's, shall be used with protection suitable to the prevailing environmental conditions (area classifying).
- b. Dependent on the noise level at the respective surroundings areas, it shall be used accessories such as acoustic buzzers (BUZ's), signaling lamps (LST's) or Integrate Buzzer and Signaling Lamp (BLT), etc.

5.13.3. Inside elevator

5.13.3.1. It shall be provided an analog line to connect to the elevator Telephony system, which junction box and telephone set will be delivered by ELEVATOR CONTRACTOR according to Technical Specification applied to Elevator.

5.14 Cable Trays

5.14.1. For the cable trays definitions follow the I-ET-3010.00-5140-700-P4X-002 SPECIFICATION FOR ELECTRICAL MATERIAL AND EQUIPMENT FOR OFFSHORE UNITS.

5.14.2. Whenever possible power cables and telephony cables should be run in separate trays to prevent electromagnetic interference. When this is not possible, the telephony cables can share the cable trays with low voltage cables, however dividers strip shall be installed to provide an electromagnetic barrier.

5.15 Jumper wires

- a. Wires used to interconnect the IDC-110 (or M10) blocks to the SAK block.
- b. It shall be 2 x 0,5mm with each conductor in different color.

| | | | |
|---|--------------------------------|--|---------------|
|  | TECHNICAL SPECIFICATION | Nº: I-ET-3010.00-5516-764-PPT-001 | REV. A |
| | AREA: - | SHEET: 18 of 25 | |
| | TITLE: | HULL TELEPHONY SYSTEM | |
| | | INTERNAL | OI/CS |

6. TECHNICAL REQUIREMENTS

- 6.1 The detailed design shall be foreseen the possibility, through strategic installation of components, to minimize the number of connections and this way, optimize costs of materials and/or work to be done.
- 6.2 The detailed design of Telephony System shall be performed in such a manner as to permit the maximum possible number of facilities (equipment, cables and accessories), to be installed during the construction of unit at shipyard site (on shore).
- 6.3 The detailed design shall make it possible, through installation of CDT (Telephony Distribution Box) at each strategic point of each module, level or area, that the off-shore installation shall be restricted merely to the interconnections between modules (CDT's), avoiding the need of running large numbers and lengths of cables in this phase.
- 6.4 Shall be foreseen an internal telephone cable with 0,50 mm diameter conductor minimum to interconnect the vertical bars with IDC-110 cutting blocks (inside the DGT) to patch panel in the PDD, in Telecommunication Room.
- 6.5 All telephone armored cables from Telephone Distribution Box (CDT), installed outside of accommodation module on industrial area, shall be terminated in the MDF/DGT at the SAK block terminals and then shall be connected on 110 IDC protector block termination or M-10 protector block termination or similar.
- 6.6 Equipment shall have its casing suitably grounded. The grounding connection by simply supporting the casing on the steel structure of the unit will not be considered appropriate.
- 6.7 Equipment, cables, boxes, materials and accessories for installation in the industrial areas of the unit (outdoor or indoor) shall be specified and assembled in accordance with applicable standards.
- 6.8 The boxes and panels shall be made with side opening door mounted on hinges permitting, at least, 180 degrees of opening. In addition, a space of at least 01 (one) meter wide shall be provided between the front of the boxes or panels and any other structure or piece of equipment, to facilitate maintenance.
- 6.9 Equipment and materials shall be specified, manufactured and assembled in accordance with applicable standard.
- 6.10 The equipment and CDT's for industrial areas shall be built in such a manner that, after installation, the rear face stay spaced away from the wall support.
- 6.11 Equipment enclosures and boxes shall be supplied with all cable passage holes sealed with plastic plugs in the holes to be used and definitive plugs (made of the same material as the equipment and accessories) in the spare holes.
- 6.12 The terminals installed inside the Distribution Boxes shall be type SAK or similar.

| | | | |
|---|--------------------------------|--|---------------|
|  | TECHNICAL SPECIFICATION | Nº: I-ET-3010.00-5516-764-PPT-001 | REV. A |
| | AREA: - | SHEET: 19 of 25 | |
| | TITLE: | HULL TELEPHONY SYSTEM | |
| | | | INTERNAL |
| | | | OI/CS |

- 6.13 For transitions between external and internal areas, it shall use MCT that shall be sealed with rubber stoppers to prevent the passage of gases between different compartments, in accordance with applicable standard.
- 6.14 To ensure proper operation of the Telephony System, it shall be taken into account the necessary care to maintain telephone cables far from energy cables in accordance with applicable standard. Crossings, if any should occur, shall be arranged at right angles.
- 6.15 All cables shall be suitable for installations in cable trays, cable ladders, conduits, shapes or ducting, the last-named exceptionally, and subject to consultation with PETROBRAS in damp or dry exposed to rainfall, liquid hydrocarbon splashing, marine atmosphere and exposure to sunshine.
- 6.16 Cables shall have no curves in their routing tighter than the limit values specified by manufacturers and in accordance with applicable standard.
- 6.17 Cables shall not have splices at any point of their run.
- 6.18 Armored cables shall be used only in areas in which there is considerable probability of accidents and to interconnection with Topsides and industrial area and in accordance with applicable standard.
- 6.19 Lashing down of cables shall comply with the following criteria:
- a. Horizontal runs, at intervals of less than 2.0 m;
 - b. Vertical runs, at intervals of less than 1.0 m;
 - c. Curves at ends only (beginning and end).
- 6.20 Cables and conductors shall be identified at both ends by means of plastic rings.
- 6.21 Cables shall be terminated in cable glands classified in accordance with the equipment they will be attached to. When equipment is not suited to the use of cable glands, the cables shall have their ends terminated with sweated-on sleeves or self-melting tape.
- 6.22 Telephony cables shall have its outer sheaths in color different from black, preferably in orange color; to define this color, CONTRACTOR shall be made understandings with PETROBRAS.
- 6.23 Boxes shall not be located in areas in which they would be exposed to the environmental elements. If this should occur, suitable boxes for the purpose and built of weather-proof and UV protection materials shall be used.
- 6.24 All grounding cables shall be specified and installed in accordance with applicable standard.

| | | | |
|---|--------------------------------|--|---------------|
|  | TECHNICAL SPECIFICATION | Nº: I-ET-3010.00-5516-764-PPT-001 | REV. A |
| | AREA: | SHEET: 20 of 25 | |
| | TITLE: | HULL TELEPHONY SYSTEM | |

- 6.25 For external areas with surrounding noise levels higher than 80 dB, telephones shall be installed in acoustic booth (full size body) or acoustic hood (half size body):
- a. Environment areas with noise levels from 80 to 95 dB should be considered the acoustics attenuator equal or higher than 20 dB;
 - b. Environment areas with noise levels higher than 95 dB should be considered acoustics attenuator equal or higher than 35 dB.
- 6.26 For internal areas with surrounding noise levels higher than 80 dB, telephones shall be installed as following:
- a. Inside acoustic hood for environment areas with noise levels from 80 to 95 dB and it shall be considered acoustics attenuator equal or higher than 20 dB;
 - b. Inside acoustic hood with headset accessory for environment areas with noise levels higher than 95 dB and it shall be considered acoustics attenuator equal or higher than 35 dB.
- 6.27 Telephones installed on harsh areas shall be housed in cabinets with ingress protection grade for the respective environmental conditions and in accordance with applicable standard.
- 6.28 Telephones housed in acoustic booths shall have buzzers with signaling lamps to perform the “ring sound” function, due the high noise area.
- 6.29 These buzzers with signaling lamps shall be fed from 220 VAC UPS to assure its safe operation and in accordance with applicable standard.
- 6.30 Desk type telephones shall be used only in offices, control-room, meeting rooms, laboratory, recreation areas, entertainment areas, hospital, equipment rooms, infirmary room, machinery spaces, warehouses, cabins, etc.
- 6.31 Close to all telephone sets there shall be a list of the main telephone extensions numbers of the FPSO Unit where the emergency extension shall be highlighted and shall have a procedure to access the interface with PAGA System. The list with the extension numbers will be provided by PETROBRAS.
- 6.32 In industrial areas, the list of extensions shall be made or fixed in place with suitable material to support harsh environments.
- 6.33 Acoustic booths shall be installed with the front protected from the main source of noise (which accounts for the greater proportion of the ambient noise).
- 6.34 If any telephone is supposed to be installed in some area

| | | | |
|---|--------------------------------|--|---------------|
|  | TECHNICAL SPECIFICATION | Nº: I-ET-3010.00-5516-764-PPT-001 | REV. A |
| | AREA: - | SHEET: 21 of 25 | |
| | TITLE: | HULL TELEPHONY SYSTEM | |

6.35 In places with a humid atmosphere as galley, laundry, bakery, HVAC room, etc, it shall be installed wall type telephone set with ingress protection minimum IP-66.

6.36 Wall type telephones shall be installed with their center of gravity about 1.50m above the floor.

7. SCOPE OF SUPPLY

7.1 CONTRACTOR shall supply, install, test and commissioning the Telephony System in PETROBRAS Unit including all necessary material scope of the Contract and in accordance with this Technical Specification.

7.2 A Telephony System shall be provided throughout the Hull, including all cabins, workstations, recreation rooms, panels rooms, messroom, galley, infirmary room, machinery spaces, warehouses, main deck, forecandle, cranes and other areas from Hull scope.

7.3 01 (one) Private Automatic Branch eXchange (PABX) with minimum configuration:

7.3.1. Trunks interfaces

- a. 02 Analog, including licenses – CES (Circuit Emulation Service), CorNet NQ, QSIG;
- b. 02 IP trucking (H323), including licenses – 10/100 BaseT;
- c. 02 SIP trucking, including licenses – 10/100 BaseT.
- d. Note: each trunk interface above shall be implemented on different interface boards, in order to ensure redundancy.

7.3.2. SIP Server

- a. The Private Automatic Branch eXchange (PABX) shall have all hardware, software and licenses for SIP SERVER implementation facilities.

7.3.3. HG CARD

- a. The PABX shall supplied with 02 (two) HGs cards with capacity for 120 DSPs each one.

7.3.4. User Interfaces

- a. 300 (three hundred) telephones IP licenses;

| | | | |
|---|--------------------------------|--|-----------------|
|  | TECHNICAL SPECIFICATION | Nº: I-ET-3010.00-5516-764-PPT-001 | REV. A |
| | AREA: - | SHEET: 22 of 25 | |
| | TITLE: | HULL TELEPHONY SYSTEM | |
| | | | INTERNAL |
| | | | OI/CS |

- b. 120 (one hundred twenty) Analog interface with user licenses (TDM license).

7.4 IP telephones

- a. 200 (two hundred) telephones set Unify OpenScape Desk Phone CP 200 SIP, or superior, for the indoor areas, including licenses;
- b. 50 (fifty) telephones set Unify OpenScape Desk Phone CP 600 SIP, or superior, for the indoor areas, including licenses.
- c. 20 (twenty) telephones set IP Wireless Phone Cisco 8821-EX SIP or superior, including licenses.

7.5 Analog industrial telephone

- a. 15 (fifteen) telephones for Ex industrial areas in accordance with Ingress Protection Enclosure rating and Protection Type adequate for hazardous areas (Ex.e) zone 01 and applicable standard (IEC 60529 and IEC 60079).
- b. 20 (twenty) telephones for internal areas in accordance with Ingress Protection Enclosure rating and Protection Type adequate for weather areas and applicable standard (IEC 60529).

7.5.1. In case of internal area can become a classified area due to reclassification of operational use, analog industrial telephone shall follow IEC 60079.

- 7.6 01 (one) set of acoustic booth, telephone signaling lamp and buzzer for each Ex telephone installed in industrial area.

- 7.7 CONTRACTOR shall supply and install all general telephone distributor, telephone interface box, telephone distribution box and telephone junction box defined during the detailed design.

- 7.8 01 (one) electrical panel with 25 (twenty-five) circuit breakers to power BLTs.

7.9 CRANE telephone interface

- 7.9.1. It shall be installed 01 (one) telephone interface for installation of 01 (one) analogic telephone in each crane.

7.10 CLOSED RACK FOR HULL TELEPHONY SYSTEM

- 7.10.1. CONTRATOR shall provide, assemble and install CLOSED RACKS, to installation of the Hull Telephony System with the specifications described below:

- a. It shall be closed, 19 inches standard, 44U height, minimum depth of 1000 mm (internal dimensions) and 800 mm of useful width (internal dimensions).

| | | | |
|---|--------------------------------|--|---------------|
|  | TECHNICAL SPECIFICATION | Nº: I-ET-3010.00-5516-764-PPT-001 | REV. A |
| | AREA: - | SHEET: 23 of 25 | |
| | TITLE: | HULL TELEPHONY SYSTEM | |
| | | INTERNAL | OI/CS |

- b. It shall have AC sockets ABNT NBR 14136 standard for 19 inches standard. This AC universal standard sockets shall be equipped, at least, 04 (four) AC outlets in additional for PETROBRAS future use.
- c. Glazed door at the front: Single-pane safety glass, 3 mm, including 130° hinge, and security lock;
- d. Sheet steel bi-parting rear door, including 130° hinge and security lock;
- e. Cooling system installed in the rear door composed by 02 (two) fans on the top (air flow out) and two fans on the bottom (air flow in);
- f. Vertical cable organizer, for Ethernet cables and optic cables;
- g. Internal light only on the rear access;
- h. Complete grounding Kit;
- i. Color: RAL 7035;

8. DIMENSIONING CRITERIA

8.1 Sizing Network Cabling

8.1.1. For sizing of the terminal strips in the CDT's, the following premise shall be taken into account:

$$NT = PA + PR + PP$$

Where:

- a. $PR = 0.3 \times PA$
- b. NT = Number of pairs for the terminal strips.
- c. PA = Active Pairs - number of pairs terminating in the CDT, for hooking up terminal equipment (telephones, facsimile devices, telephone receptacles, data equipment, etc);
- d. PR = Reserve Pairs - number of pairs terminating in the CDT, on the terminal strips, for expansion of the Telephone System;
- e. PP = Passing Pairs - number of pairs terminated in the CDT and connected to another consecutive CDT.

8.1.2. Telephone cables for each run shall be sized in accordance with the following formula:

$$NF = 1.2 \times NT$$

Where:

- a. NF = Final number of pairs (quantity)
- b. NT = Total number of terminal pairs

8.2 CONTRACTOR shall consider the figure below as a project reference:

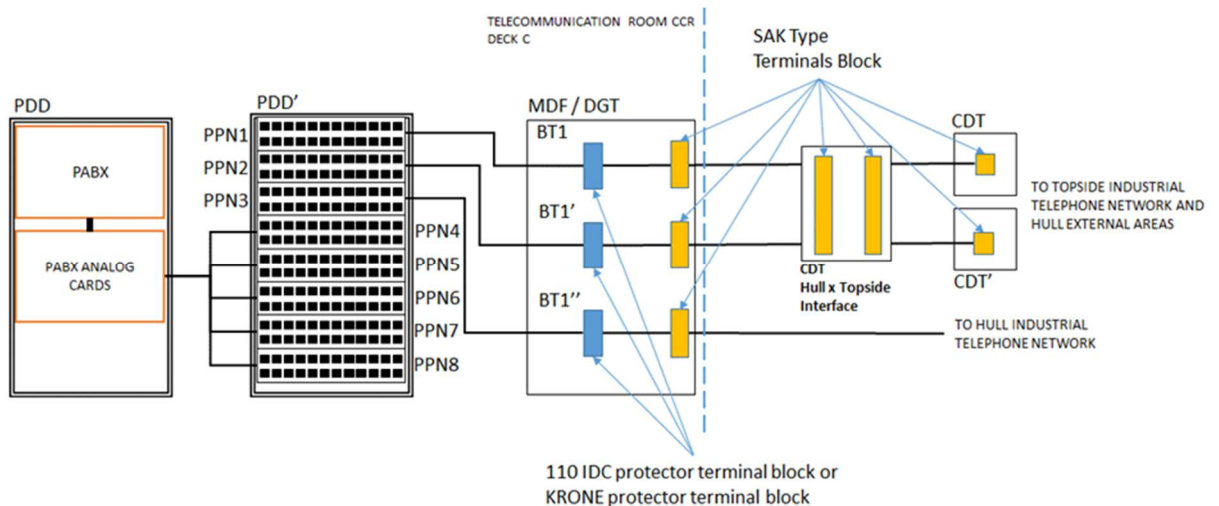

Figure 7: Reference schematic drawing to detailed design

9. COMMISSIONING

9.1 For commissioning activities CONTRACTOR shall follow 03 (three) distinct phases: visual inspection, test measurements and documentation verification.

9.1.1. On visual inspection phase, shall be verified the:

- a. Detailed design infrastructure requirements;
- b. Grounding and bonding;
- c. Equipment placement and fixation: PABX, TEL, BLT;
- d. Cables placement and organization on cable trays or ladder;
- e. Cables, conductors and equipment labeling (TAG);
- f. Cables organization, fixation on panels or distribution boxes;
- g. Conductors organization, fixation and termination in panels or distribution boxes;
- h. Cables and conductors organization, fixation and termination on equipment.

9.1.2. On test measurements phase, shall be verified the:

- a. Operating equipment: PABX, TEL, BLT;

| | | | |
|---|--------------------------------|--|---------------|
|  | TECHNICAL SPECIFICATION | Nº: I-ET-3010.00-5516-764-PPT-001 | REV. A |
| | AREA: - | SHEET: 25 of 25 | |
| | TITLE: | HULL TELEPHONY SYSTEM | |
| | | INTERNAL | OI/CS |

- b. Cables continuity;
- c. Cables impedance;
- d. Cables capacitance;
- e. Cables resistance;
- f. Cables inductance.

9.1.3. On document verification phase, it shall be verified:

- a. Identification Report: Equipment, racks, panels, boxes, cable, conductors, pathway identifier (TAG);
- b. Cable Summary Report: specification, cable type, terminating positions, non-terminating positions, available pairs, available conductors;
- c. End-to-End Circuit: associated termination positions.

9.2 CONTRACTOR TECHNICAL REQUIREMENTS

9.2.1. CONTRACTOR shall dispose professionals to meet the quality of the technical service and the deadlines agreed with PETROBRAS. These professionals shall have basic manufacturer certification with at least two years of experience in configuring and deploying PABX.

9.2.2. The technical staff shall be responsible for all activities, including configuration, licensing and testing.

9.3 As a matter of acceptance, incoming and outgoing call tests shall be done locally and to Brazil and the automatically switchover between AC to DC power and vice-versa shall succeed.