

|   |   |  |
|---|---|--|
|  | <b>TECHNICAL SPECIFICATION</b>                    | Nº: <b>I-ET-3010.00-5517-768-PPT-004</b> |
|   | CLIENT: <b>SRGE</b>                               | SHEET: <b>1</b> of <b>23</b>             |
|   | JOB: <b>TELECOMMUNICATION DATA</b>                |  |
|   | AREA: <b>-</b>                                    |  |
| <b>TIC</b>  | TITLE: <b>TOPSIDES STRUCTURED CABLING NETWORK</b> | <b>INTERNAL</b><br><b>OI/CS</b>          |

MICROSOFT WORD / V.2016 / I-ET-3010.00-5517-768-PPT-004\_B.docx

**INDEX OF REVISIONS**

| REV. | DESCRIPTION AND/OR REVISED SHEETS |
|------|-----------------------------------|
| 0    | ORIGINAL ISSUE                    |
| A    | REVISED WHERE INDICATED           |
| B    | REVISED WHERE INDICATED           |

|           | REV. 0    | REV. A      | REV. B      | REV. C | REV. D | REV. E | REV. F | REV. G | REV. H |
|-----------|-----------|-------------|-------------|--------|--------|--------|--------|--------|--------|
| DATE      | APR/08/22 | OCT/25/2022 | NOV/10/2022 |        |        |        |        |        |        |
| DESIGN    | PROJ-US   | PROJ-US     | PROJ-US     |        |        |        |        |        |        |
| EXECUTION | Y3S7      | Y3S7        | Y3S7        |        |        |        |        |        |        |
| CHECK     | CY22      | CY22        | CY22        |        |        |        |        |        |        |
| APPROVAL  | X187      | X187        | X187        |        |        |        |        |        |        |

INFORMATION IN THIS DOCUMENT IS PROPERTY OF PETROBRAS, BEING PROHIBITED OUTSIDE OF THEIR PURPOSE  
 FORM OWNED TO PETROBRAS N-0381 REV. L



|   |  |               |
|---|--|---------------|
| <b>TECHNICAL SPECIFICATION</b>                    | Nº: <b>I-ET-3010.00-5517-768-PPT-004</b> | REV. <b>B</b> |
| AREA: -   | SHEET: 2 of 23                           |               |
| TITLE: <b>TOPSIDES STRUCTURED CABLING NETWORK</b> | INTERNAL                                 |               |
|   | OI/CS                                    |               |

INDEX

|     |  |    |
|-----|--|----|
| 1.  | SUBJECT .....                                  | 3  |
| 2.  | ABBREVIATIONS.....                             | 3  |
| 3.  | REFERENCE DOCUMENTS, CODES AND STANDARDS ..... | 4  |
| 4.  | GENERAL REQUIREMENTS .....                     | 5  |
| 5.  | SYSTEM DEFINITIONS.....                        | 7  |
| 6.  | TECHNICAL REQUIREMENTS .....                   | 8  |
| 7.  | SCOPE OF SUPPLY .....                          | 15 |
| 8.  | DIMENSIONING CRITERIA .....                    | 18 |
| 9.  | COMMISSIONING .....                            | 22 |
| 10. | ANNEX.....                                     | 22 |

|   |                                |  |               |
|---|--------------------------------|--|---------------|
|  | <b>TECHNICAL SPECIFICATION</b> | <b>Nº: I-ET-3010.00-5517-768-PPT-004</b>   | <b>REV. B</b> |
|   | AREA: -                        | SHEET: 3 of 23                             |               |
|   | TITLE:                         | <b>TOPSIDES STRUCTURED CABLING NETWORK</b> | INTERNAL      |

## 1. SUBJECT

- 1.1 The subject of this document is to establish the criteria and basic characteristics for the detailed design, supply and installation of STRUCTURED CABLING AND OPTICAL DATA NETWORK (LAN) that shall be installed in TOPSIDE of PETROBRAS FPSO Unit.
- 1.2 The connections of the TOPSIDES STRUCTURED CABLING NETWORK to HULL STRUCTURED NETWORK in the interface box is scope of this Technical Specification.
- 1.3 It is basically a Local Structured Cabling Network - CAT 6 Multimedia with resources of UTP cables and optical fibers to attend required areas, interconnect equipment and devices, to extend to some external areas and to allow the interface with Hull for:
- a. Corporative voice and data communications (RIC);
  - b. Industrial automation communications (RAI);
  - c. Corporative and Entertainment IPTV;
  - d. Industrial WLAN;
  - e. CCTV.

## 2. ABBREVIATIONS

|         |   |
|---------|---|
| ABNT    | Associação Brasileira de Normas Técnicas (Brazilian Association of Technical Standards) |
| ANSI    | American National Standards Institute   |
| CP      | WLAN Controller   |
| DIO     | Optical Internal Distributor  |
| ECD     | Data Communications Equipment   |
| EIA     | Electronic Industries Alliance  |
| FO      | Optic Fiber   |
| FW      | Firewall  |
| GK      | Access Media Gateway (Gatekeeper)   |
| IEC     | International Electrotechnical Commission   |
| IMP     | Printer   |
| INMETRO | Instituto Nacional de metrologia (national institute of Metrology)                      |
| IP      | Ingress Protection  |
| ISO     | International Organization for Standardization  |
| MCO     | Microcomputer (Workstation)   |
| NBR     | Brazilian Standard  |
| NR      | Regulatory Standard   |
| OTDR    | Optical Time-Domain Reflectometer   |
| OW      | WAN optimizator   |
| PA      | WLAN Access Point   |
| PDD     | Data Distributor Panel  |

|   |                         |                                     |                |
|---|-------------------------|-------------------------------------|----------------|
|  | TECHNICAL SPECIFICATION | Nº: I-ET-3010.00-5517-768-PPT-004   | REV. B         |
|   | AREA:                   | -                                   | SHEET: 4 of 23 |
|   | TITLE:                  | TOPSIDES STRUCTURED CABLING NETWORK |                |
|   |                         |                                     | OI/CS          |

|     |   |
|-----|---|
| PoE | Power Over Ethernet                     |
| PP  | Patch Panel                             |
| ROT | Router                                  |
| SVR | Server                                  |
| SW  | Layer 2 Switch                          |
| SW  | Layer 3 Switch                          |
| TIA | Telecommunications Industry Association |
| TMD | Data Plug Socket                        |

### 3. REFERENCE DOCUMENTS, CODES AND STANDARDS

- 3.1 The detailed design shall be made, at least, in accordance with requirements of those International and National Standards listed below:
- a. ABNT NBR 5410 – Instalações Elétricas de Baixa Tensão;
  - b. ABNT NBR 14565 – Cabeamento de telecomunicações para edifícios comerciais;
  - c. ANSI/EIA/TIA 568-B2-1 – Commercial Building Telecommunications Cabling Standard;
  - d. ANSI/EIA/TIA 568-C.2 – Balanced Twisted-Pair Cabling Components;
  - e. ANSI/EIA/TIA 568.3-D – Optical Fiber Cabling Components Standard
  - f. IEC 61892 – Mobile and fixed offshore units – Electrical installations – All Parts;
  - g. IEC 60079 – Explosive Atmospheres – All Parts;
  - h. IEC 60092 – Electrical installations in ships – All Parts;
  - i. IEC 60331 – Fire-resisting characteristics of electric cables;
  - j. IEC 60332 – Flame-retardant characteristics of electric cables;
  - k. IEC 62444 – Cable glands for electrical installations;
  - l. IEC 60228 – Conductors of insulated cables;
  - m. IEC 60529 – IP Protection Degree – All Parts
  - n. ISO/IEC 11801 – Information Technology – Generic cabling for customer premises.
  - o. ITU-T G651 - Series G: Transmission systems and media, digital systems and networks;
  - p. INMETRO/Portaria nº 115, March 21st 2022 and its annexes.
- 3.2 Electrical installations, equipment and materials shall comply with the requirements of IEC 60079, IEC 61892-7 and Classification Society.

|   |   |  |               |
|---|---|--|---------------|
|  | <b>TECHNICAL SPECIFICATION</b>                              | <b>Nº: I-ET-3010.00-5517-768-PPT-004</b> | <b>REV. B</b> |
|   | <b>AREA:</b> -  | <b>SHEET:</b> 5 of 23                    |               |
|   | <b>TITLE:</b><br><b>TOPSIDES STRUCTURED CABLING NETWORK</b> | <b>INTERNAL</b><br><b>OI/CS</b>          |               |

3.3 All equipment, installations and materials shall be of type approved and certified by international recognized laboratory and shall be in accordance with INMETRO Portaria nº 115, March 21st 2022 and its annexes.

3.4 It shall be observed all Normas Regulamentadoras (NR's) –MINISTÉRIO DO TRABALHO applicable for this Technical Specification, especially NR-10 and NR-37.

#### 4. GENERAL REQUIREMENTS

4.1 For PETROBRAS detailed design requirements, Installation, Configuration, Tests training and Commissioning CONTRACTOR shall comply with the DESCRIPTIVE MEMORANDUM I-MD-3010.00-5510-760-PPT-001 – GENERAL CRITERIA FOR TELECOMMUNICATIONS DESIGN

4.2 For telecommunications symbols, the Detailed Design shall comply with the Technical Specification: I-ET-3000.00-0000-940-P4X-002 – SYMBOLS FOR PRODUCTION UNITS DESIGN.

4.3 For telecommunications TAGs, the Detailed Design shall comply with the Technical Specification: I-ET-3000.00-1200-940-P4X-001 – TAGGING PROCEDURE FOR PRODUCTION UNITS DESIGN.

4.4 For telecommunications infrastructure materials, accessories, cable trays, cable ladders, the Detailed Design shall comply with all electrical requirements for telecom package and shall be in accordance with I-ET-3010.00-5140-700-P4X-003 – ELETRICAL REQUIREMENTS FOR PACKAGES FOR OFFSHORE, I-ET-3010.00-5140-700-P4X-001 - SPECIFICATION FOR ELECTRICAL DESIGN FOR OFFSHORE UNITS, I-DE-3010.00-5140-700-P4X-003 - GROUNDING INSTALLATION TYPICAL DETAILS and I-ET-3010.00-5140-700-P4X-005 - REQUIREMENTS FOR HUMAN ENGINEERING DESIGN FOR ELECTRICAL SYSTEMS OF OFFSHORE UNITS.

4.5 CONTRACTOR shall provide all the materials to install all equipment, accessories, cables and infrastructure that compose the STRUCTURED CABLING AND OPTICAL DATA NETWORK (LAN).

4.6 The equipment and accessories shall attend the ingress protection degree, protection type, classifications zone and groups established by IEC / ABNT.

4.7 CONTRACTOR shall supply all equipment, cables and accessories approved and certificated by Classifying Society and technical conformity with the International and National standardization organism: ABNT, IEC and INMETRO.

4.8 Equipment and accessories installed in outdoor or industrial areas shall be suitably rugged and their external bodies shall be made in non-metallic material, suitable for harsh environments and in accordance with IEC and ABNT standards, apart from the ones whose classification area require to be metallic as Ex-d junction boxes.

|   |                                |  |                   |
|---|--------------------------------|--|-------------------|
|  | <b>TECHNICAL SPECIFICATION</b> | <b>Nº: I-ET-3010.00-5517-768-PPT-004</b>   | <b>REV. B</b>     |
|   | AREA: -                        | SHEET: 6 of 23                             |                   |
|   | TITLE:                         | <b>TOPSIDES STRUCTURED CABLING NETWORK</b> |                   |
|   |                                |  | INTERNAL<br>OI/CS |

- 4.9 Brackets, bolts, nuts, washers and any other mechanical fixing elements shall be made in stainless steel.
- 4.10 In case of difficulty for supplying some accessory with external body made with non-metallic materials, it will be necessary to submit them for analysis and approval of PETROBRAS.
- 4.11 It shall be avoided equipment and accessories with their external bodies built in aluminum alloy. Anything different shall be submitted to PETROBRAS approval. In case of approval, this alloy shall not contain in its composition more than 0.25 % of copper and shall comply with the ASTM-B-179 standard (ANSI alloy 356.1).
- 4.12 In outdoor areas, exposed to marine atmosphere, CONTRACTOR shall avoid the galvanic corrosion of junction boxes supports, horns supports and bolts. Galvanic insulation shall be implemented wherever contact between different metallic materials is needed.
- 4.13 The equipment and materials shall be supplied packed suitable for long periods of storage and be protected against mechanical impact and adverse weather conditions.
- 4.14 The equipment and materials shall be supplied and installed with all threads, hinges, bolts, cover plug, cable glands and flanges lubricated with anti-seize (loctite) or similar grease.
- 4.15 Equipment and materials shall be supplied with cable passage holes sealed with plastic plugs in the holes to be used and definitive plugs (made of the same material as the equipment and accessories) in the reserve holes.
- 4.16 Electrical equipment installed in external (open) safe areas, foreseen to operating during emergency shutdown ESD-3 shall be certified for installation in hazardous areas Zone 2 Group IIA temperature T3, according to IEC 61892-1.
- 4.17 CONTRACTOR shall ensure by inspection of a qualified personnel that all equipment installations are according to the IEC/ABNT standards requested in this technical specification.
- 4.18 The Structured Cabling shall be a Gigabit Ethernet network that will allow the use of the VOICE and DATA PETROBRAS Corporate network.
- 4.19 All Structured Cabling Network shall be tested and certificated and the results of all tests shall be submitted to PETROBRAS.
- 4.20 All Structured Cabling Network shall be identified in both ends (sockets and path panel).
- 4.21 It shall be installed one cable organizer between each communication data equipment, patch panels and DIOs.
- 4.22 The structured cabling network shall follow the CAT 6 Certification and the Standards NBR 14565, ANSI/EIA/TIA 568-(Balanced Twisted-Pair and Optical Fiber Cabling

Cabling latest revisions), ANSI/EIA/TIA-569A, ANSI/EIA/TIA-606 and ANSI/EIA/TIA-607.

4.23 The communication data equipment as, routers, switches, gateways, computers and printers are not part of the scope of this Technical Specification, although there shall be space foreseen in the racks for the installation of all equipment installed in the racks.

## 5. SYSTEM DEFINITIONS

- 5.1 The physical topology of the network shall be "star" type and it shall transport a Gigabit Ethernet network that will allow the use of the PETROBRAS data network.
- 5.2 02 (two) fiber optic interface junction boxes will be installed by HULL supplier in the external area of MAIN DECK for interface to TOPSIDE areas and MODULES.
- 5.3 CONTRACTOR shall be responsible to interconnect the HULL fiber optic interface junction boxes with the Optical Data Network installed in the TOPSIDE, MODULES and MAIN DECK.
- 5.4 The FTP structured cabling located in topside administrative areas shall be part of this Technical Specification.
- 5.5 Each data point in diving areas shall be attended by Optical Cable with Optical Distributor, Optical-Electrical Converter and external power supply housed in appropriated enclosure for hazardous areas. It shall be installed an electrical infrastructure to feed the Optical-Electrical Converter.

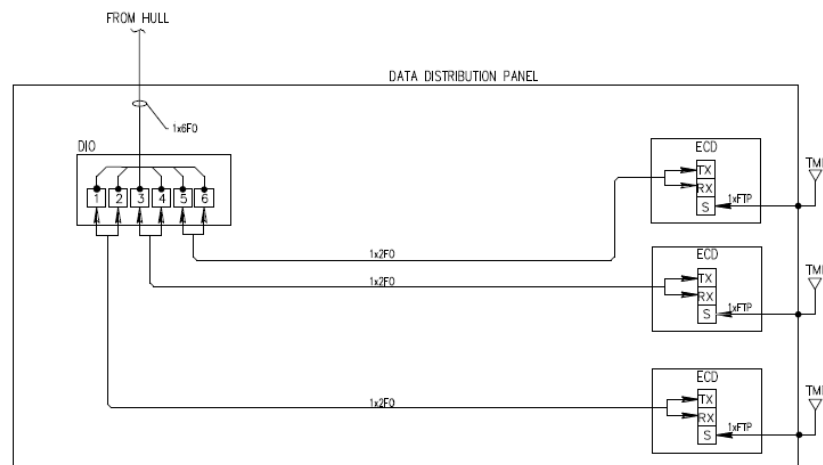



Figure 01: Typical Data Connection Box Block diagram

|   |   |  |               |
|---|---|--|---------------|
|  | <b>TECHNICAL SPECIFICATION</b>                              | <b>Nº: I-ET-3010.00-5517-768-PPT-004</b> | <b>REV. B</b> |
|   | <b>AREA:</b> -  | <b>SHEET:</b> 8 of 23                    |               |
|   | <b>TITLE:</b><br><b>TOPSIDES STRUCTURED CABLING NETWORK</b> | <b>INTERNAL</b><br><b>OI/CS</b>          |               |

## 6. TECHNICAL REQUIREMENTS

### 6.1 FTP CATEGORY 6 CABLING

- 6.1.1. Cable of twisted pair (FTP) shall attend the Standards and composed for 04 (four) equal, 24 AWG, 100 Ohms, rigid copper drivers with isolation in high density polyethylene, with electric and mechanics characteristics compatible with the established patterns and tested up to 250MHz so that throughput can reach up to 1 Gbps. It shall have outer sheath with fire retardant material and LSZH.
- 6.1.2. The Cables FTP CAT 6 shall have the UL Register and Certification via Laboratory of international recognition for parameters that attend the Standards.
- 6.1.3. Whole horizontal cabling FTP CAT 6 shall be connected to a group of Patch Panels CAT 6 with 24 positions (1U high) in the central point of distribution (in the telecommunications racks).
- 6.1.4. The horizontal cabling FTP CAT 6 in the user side (outlet) shall have a group of two female connectors RJ-45 CAT6.
- 6.1.5. All the necessary accessories for installing the CAT6 cabling shall be foreseen in the detailed design and supplied by CONTRACTOR.
- 6.1.6. All the FTP cables shall be identified in its both extremities, using polyester labels printed mechanically in an indelible way. In the same way shall be identified all the other components of the network as: Patch Panel, fiber optic cables, Patch Cords and Sockets.
- 6.1.7. All patch panel shall have rear support bar to facilitate the cables organization on patch panel rear and to avoid unnecessary stresses on the cables connections.
- 6.1.8. The organization of the cables inside the racks shall use only velcro. On cable trays, the cabling shall be tied with black plastic tie wraps.

### 6.2 MULTIMODE OPTICAL FIBER CABLE

- 6.2.1. The optical cables shall be of TIGHT Buffered type, fully waterproof, longitudinally and radially, constituted by fiber optic with primary covering in acrylic and secondary covering in material colored polymer, gathered and covered by dielectric synthetic fibers for mechanical support (resistance to the traction). Covered by an external layer of special polymeric for external use with protection UV and fire retardant and LSZH.
- 6.2.2. The network points where there is a technical non viability of service for cable FTP due to the access characteristics (distance) or Hazardous Areas, it shall be assisted by multimode optical fiber cable type OM-4 of 50  $\mu\text{m}$  x 125  $\mu\text{m}$  with at least 6 fibers, according to ANSI/TIA-568.3-D, ISO/IEC 11801 and ITU-T G651.



|   |   |  |               |
|---|---|--|---------------|
|  | <b>TECHNICAL SPECIFICATION</b>                              | <b>Nº: I-ET-3010.00-5517-768-PPT-004</b> | <b>REV. B</b> |
|   | <b>AREA:</b> -  | <b>SHEET:</b> 9 of 23                    |               |
|   | <b>TITLE:</b><br><b>TOPSIDES STRUCTURED CABLING NETWORK</b> | <b>INTERNAL</b>                          |               |
| <b>O/CS</b>   |   |  |               |

6.2.3. The optical cables coming from the operational area shall be finished in DIO pattern 19 inches 1U of 24 or 36 positions with SC-PC connectors on the Structured Network Racks in M-13, M-15B and M-17.

6.2.4. In the operational area when there is possibility of concentration of several users in a same installation place, the installation of a distribution small rack shall be foreseen for the fiber optic cable used as Backbone. This optical cable shall be terminated in DIO pattern 19 inches of 24 (twenty four) positions with SC-PC.

6.2.1. For racks interconnections, telecom rooms interconnections, topside interface junction box and uplink interconnection between switches, it shall be used multimode optical fiber cable (MM) of 50  $\mu\text{m}$  x 125  $\mu\text{m}$  with number of fibers sized according to this technical specification and DATA NETWORK ONE LINE DIAGRAM.

6.2.1.1. As all switches shall be interconnected by 25Gbps SFP interface, the optical mode (OM) of such fibers to be considered shall be OM-4 (MM 50  $\mu\text{m}$  x 125  $\mu\text{m}$ ), following ANSI/TIA-568.3-D, ISO/IEC 11801 and ITU-T G651 according to the throughput expected and the bigger expected distance between equipment.

### 6.3 Ethernet/Optical Multimode Converter - Standalone

- a. Electrical Interface – 100/1000BASE-TX RJ-45 with IEEE 802.3bt PoE (with power injector that shall be able to be enabled or disabled by a switch).
- b. Optical interface - Multimode G.651.
- c. Core diameter - 50 $\mu\text{m}$ .
- d. Standard –1000BASE-FX SC-PC.
- e. Number of fibers - 2 fibers.
- f. Installation – Standalone box.
- g. Connector – SC.
- h. Operating temperature -10°C to + 50°C.
- i. Link failure pass-through and end failure (to identify loss caused by link failure).
- j. Auto MDI / MDI-X for TX port.

### 6.4 OPTIC PATCH CORDS

6.4.1. Apart from Diving Station junction boxes, whenever a single junction box is due to be interconnected by a single fiber optic cable, this cable shall have enough fibers to attend equipment as designed and at least 04 (four) extra fibers (02 pairs) fully ended in DIO position with SC-PC interfaces at both ends and every device shall be adequate for the area to be applied.

|   |                                |  |                  |
|---|--------------------------------|--|------------------|
|  | <b>TECHNICAL SPECIFICATION</b> | <b>Nº: I-ET-3010.00-5517-768-PPT-004</b>   | <b>REV. B</b>    |
|   | AREA: -                        | SHEET: 10 of 23                            |                  |
|   | TITLE:                         | <b>TOPSIDES STRUCTURED CABLING NETWORK</b> |                  |
|   |                                |  | INTERNAL<br>O/CS |

6.4.2. At the DIO shall be used an optical extending multimode (MM) of 50 µm x 125 µm with SC-PC / SC-PC connectors in OM-4 color standard. It shall be foreseen by CONTRACTOR the supply of an excess of 30% for this item for future expansion and spare.

6.4.3. The interconnection of DIO with the active elements of network, shall be used optical multimode patch cords (MM) of 50µm x 125µm in the OM-4 color standard and SC-PC / LC-PC connectors. It shall be foreseen by CONTRACTOR the supply of an excess of 30% for this item for future expansion and spare.

6.4.4. The optical patch cords shall have suitable length to the rack or junction box where they will be installed.

6.4.5. Whenever required a longer optical patch cords shall be supplied to interconnect distant racks or panels inside M-17 module, as from RRMS and MODA cabinets.

#### 6.5 PATCH CORD RJ-45 CAT 6

6.5.1. Patch Cords category 6/Class E shall be finished in factory with connector RJ-45 male, with plastic layer (boot) inserted in the connector to relieve the tensions and to avoid the accidental disconnection and the connector shall be shielded. They shall be built with flexible FTP 24 AWG cable. Each patch cord shall have its whole performance 100% tested in factory regarding the Cat. 6 of the standard ANSI/TIA/EIA 568-C.2.

6.5.2. Patch Cords shall be of 1.5 meters and 2.5 meters, in the Blue Color, for LAN System connections.

6.5.3. The outer sheath owes being of fire retardant type and LSZH, with demarcation of indelible length.

6.5.4. Patch Cord shall present acting values in the center of the strip of the values (center tuned) certain for the norm ANSI/TIA/EIA-568B2-1 for NEXT.

#### 6.6 RJ-45 MALE CONNECTOR

6.6.1. RJ-45 male connector shall be engineered correctly and manufactured with precision processes to ensure that the connection is just going to work. Following the minimum requirements for RJ-45 male connector.

- a. Performance category: CAT6
- b. Applications standard: TIA/EIA-568-C
- c. Cable type: FTP
- d. Conductor type: Solid
- e. Housing material: Polycarbonate

- f. UL flammability rating: UL94V-2 [RoHS Compliant]
- g. Contact type: Three prong pin for solid/stranded wires
- h. Contact material: copper
- i. Contact plating: Gold Plating 50µ [1.27µm]
- j. Impedence: 100 ohms
- k. Conductor Diameters: 0.41mm to 0.51mm (26AWG to 24AWG)
- l. Shielded

### 6.7 RJ-45 FEMALE CONNECTOR

6.7.1. The RJ-45 female connector shall be used in all female data sockets.

6.7.2. RJ-45 female connector shall be engineered correctly and manufactured with precision processes to ensure that the connection is just going to work. Following the minimum requirements for RJ-45 female connector.

- a. Compliant with EIA/TIA Cat6 connecting hardware specifications
- b. Connector: Female RJ-45, IDC compatible with 110 & Krone
- c. Compatible cables: 4 pairs, FTP cable 22 – 26 AWG
- d. UL-certified ANSI/TIA/EIA-568-C
- m. Impedence: 100 ohms

### 6.8 PATCH PANEL CAT 6

6.8.1. Patch Panel shall be modular made in metallic material with width of 19 inches according to norm ANSI/TIA/EIA-310D, with 24 connectors type RJ-45 female and 1 U of height.

6.8.2. It shall have a cables guide (bar) in rear for supporting and fastening of cables.

6.8.3. All specifications of components shall comply with Category 6 /Class E ANSI/TIA/EIA 568-C.

6.8.4. The modules shall have structure built in plastic of high impact, fire retardant type called UL 94V-0. The circuits printed papers shall totally be contained inside the patch panel, in other words, the panel shall contain protection for the circuits printed, avoiding damages to the same ones during the connectors installing process.

6.8.5. Patch panels for mirroring interconnection between racks or other panels/cabinets shall be dedicated ones, different from the ones dedicated to users (computers, printers, access points, cameras).

## 6.9 CABLE ORGANIZER

6.9.1. It shall be installed one cable organizer between each communication data equipment, patch panels and DIOs with the specs below:

- a. 01 U cable rack mount manager
- b. Mounted horizontally in 19" rack
- c. Rear cut-outs to allow cabling to be fed through the back
- d. With cover



Figure 2: Example of cable organizer

## 6.10 CLOSED RACK FOR DATA EQUIPMENT AND CABLING NETWORK

6.10.1. CONTRACTOR shall provide, assemble and install CLOSED RACKs, to installation of all systems described below:

- a. Structured Cabling described in this specification named as LAN racks,
- b. All data equipment listed in TOPSIDES DATA NETWORK ONE LINE DIAGRAM

6.10.2. The rack shall be closed, pattern 19 inches, 44U of height and minimum of 870 mm of useful depth (intern dimensions). The maximum width allowed for the rack is 800 mm.

6.10.2.1. Only for M-15B, it shall be installed a rack with dimensions 800 mm (depth) x 600 mm (width; front view).

6.10.3. This rack shall have structure in metal foil at least of #1,5 mm, screwed in, with adjustable feet, with support in rubber.

6.10.4. The front door shall allow minimum 135° opening and to be built with tempered glazed of 3,0 mm with door stay and security lock.

6.10.5. Sheet steel bi-parting rear door, including 130° hinge and security lock.

6.10.6. It shall have 04 (four) vertical organizing columns, two in the front access and two in the rear access, with objective to organize the FTP cables and path cords cables.

|   |                                |  |               |
|---|--------------------------------|--|---------------|
|  | <b>TECHNICAL SPECIFICATION</b> | <b>Nº: I-ET-3010.00-5517-768-PPT-004</b>   | <b>REV. B</b> |
|   | AREA: -                        | SHEET: 13 of 23                            |               |
|   | TITLE:                         | <b>TOPSIDES STRUCTURED CABLING NETWORK</b> | INTERNAL      |

- 6.10.7. The roof shall be in metal foil of at least #1,5 mm with four fans, 220 VAC outlets in a body of injected aluminum, with tension commuting key, fuse, on/off key and service socket.
- 6.10.8. All the fixing supports of the organizing columns of cables and other fixations in foil shall be of at least #2,75 mm of thickness.
- 6.10.9. It shall be equipped with 02 (two) power strip 2P+T with individual capacity of 25 Amperes and minimum 06 (six) sockets each one. The power strips can be fastened vertically in the back part of rack.
- 6.10.10. It shall be supplied cage nuts (M5/M6) and screws (at least 15 mm) for all of the positions.
- 6.10.11. A cooling system shall be installed for each cabinet and it shall be composed by 02 (two) fans on the bottom to inflate cold air inside and 02 (two) fans on the top to exhaust heated air to be collected by exhausters on ceiling. Additional clarifications for HVAC at I-MD-3010.00-5510-760-PPT-001 GENERAL CRITERIA FOR TELECOMMUNICATIONS DESIGN;
- 6.10.12. Internal light only on the rear access;
- 6.10.13. Complete grounding kit;
- 6.10.14. Color: RAL 7035;
- 6.10.15. The number of racks that shall be installed at the topside module presented on Basic Project one line diagram and arrangement drawing shall attend the whole demand of network points and equipment of the structured local network, in accordance with distribution requirements and the Detailed Design Arrangement Document.

## 6.11 DATA CONNECTION BOX

- 6.11.1. The data connection box, also known as junction box, shall be specified for external and hazardous areas, in accordance with environment requirement.
- 6.11.1. The data connection box shall be specified with 03 (three) external RJ-45 female connectors with covers appropriate to environment requirement.

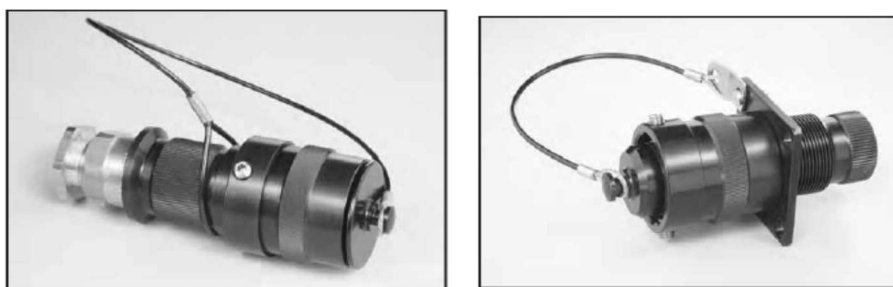

Figure 3: Examples of external RJ-45 female connectors

|   |  |               |
|---|--|---------------|
| <b>TECHNICAL SPECIFICATION</b>                    | Nº: <b>I-ET-3010.00-5517-768-PPT-004</b> | REV. <b>B</b> |
| AREA: -   | SHEET: 14 of 23                          |               |
| TITLE: <b>TOPSIDES STRUCTURED CABLING NETWORK</b> | INTERNAL                                 |               |
|   | OI/CS                                    |               |

6.11.2. In addition it shall be supplied 03 (three) STP cables with 10 (ten) meters terminated with male RJ-45 connector for hazardous areas for each Data Connection Box as a standalone delivery.



Figure 4: Examples of STP patch cord for hazardous areas

6.11.3. In the data connection box of Diving Stations, the optical cables shall be terminated in a DIO 06 (six) positions with SC connectors, interconnected with 03 (three) Optical Electrical Converters.



Figure 5: Typical Data Connection Box

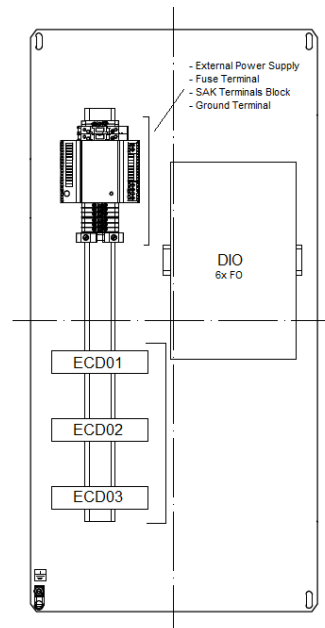

Figure 6: Typical Data Connection Box inside arrangement

## 6.12 TYPICAL RACK BAY FACE

6.12.1. Following below the typical bay face of the LAN racks that shall follow by CONTRACTOR during the detailed design.

- a. In the LAN rack the number of switches shall be sized according to LAN cables terminated in each patch panel;
- b. It shall be installed one cable organizer between each device;

- c. The AC switchboard and DC switchboard can be installed in the top of rack or in the bottom of rack.

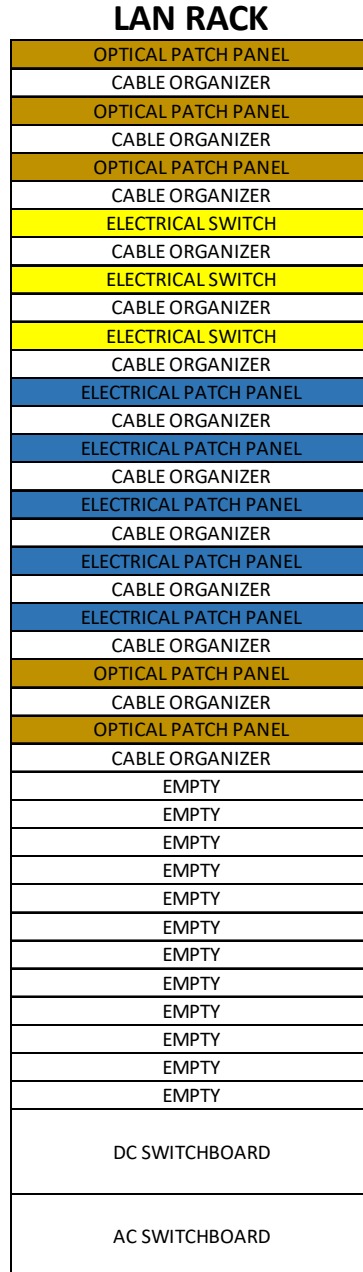



Figure 7: Typical bay face of the LAN racks

**7. SCOPE OF SUPPLY**

- 7.1 CONTRACTOR shall supply, install, test and commissioning the TOPSIDE STRUCTURED CABLING NETWORK, within the scope of the Contract and in accordance with this Technical Specification.
- 7.2 CONTRACTOR shall be responsible to supply all materials necessary to complete installation of the topside Structured Cabling Network.

|   |   |  |               |
|---|---|--|---------------|
|  | <b>TECHNICAL SPECIFICATION</b>                              | <b>Nº: I-ET-3010.00-5517-768-PPT-004</b> | <b>REV. B</b> |
|   | <b>AREA:</b> -  | <b>SHEET:</b> 16 of 23                   |               |
|   | <b>TITLE:</b><br><b>TOPSIDES STRUCTURED CABLING NETWORK</b> | <b>INTERNAL</b><br><b>OI/CS</b>          |               |

7.3 The material and installation service shall be concerning the following activities.

- a. Design for the network to be installed;
- b. Supply the material;
- c. Installation of cabling and connectors;
- d. Tests and Certification of the whole installed network;
- e. Physical identification of all components of network;
- f. Network Technical documentation;
- g. Supplying of test equipment and appropriate tools.

7.4 LAN cables (Final quantity shall be defined during the detailed design).

7.5 Fiber optic cables (Final quantity shall be defined during the detailed design).

7.6 Patch panels (Final quantity shall be defined during the detailed design).

7.7 DIOs (Final quantity shall be defined during the detailed design).

7.8 Cables organizer (Final quantity shall be defined during the detailed design).

7.9 RJ-45 Female sockets (Final quantity shall be defined during the detailed design considering 20% as spare).

7.10 200 (two hundred) Patch Cords with 1,5 meters, in the Blue Color, for LAN System connections.

7.11 200 (two hundred) Patch Cords with 2,5 meters, in the Blue Color, for LAN System connections

7.12 50 (fifty) optical multimode duplex patch cords SC-PC/SC-PC with 1,5 meters, in OM-4 color standard.

7.13 50 (fifty) optical multimode duplex patch cords SC-PC/SC-PC with 6 meters, in OM-4 color standard.

7.14 100 (two hundred) optical multimode duplex patch cords SC-PC/LC-PC with 1,5 meters, in OM-4 color standard.

7.15 100 (a hundred) optical multimode duplex patch cords SC-PC/LC-PC with 4 meters, in OM-4 color standard.

7.16 20 (twenty) optical multimode duplex patch cords SC-PC/LC-PC with 6 meters, in OM-4 color standard.

7.17 170 (one hundred-seventy) optical multimode duplex patch cords SC-PC/SC-PC with 1,5 meters, in the OM-4 color standard, for interconnections inside interface junction boxes.



|   |                                |  |                  |
|---|--------------------------------|--|------------------|
|  | <b>TECHNICAL SPECIFICATION</b> | <b>Nº: I-ET-3010.00-5517-768-PPT-004</b>   | <b>REV. B</b>    |
|   | AREA: -                        | SHEET: 17 of 23                            |                  |
|   | TITLE:                         | <b>TOPSIDES STRUCTURED CABLING NETWORK</b> |                  |
|   |                                |  | INTERNAL<br>O/CS |

- 7.18 In spite of the length of optical duplex patch cord has been informed, the length of each optic patch cord shall be as long enough to connect the DIO port to switch port.
- 7.19 All quantities previously listed are the minimum to be supplied. However, the final quantities shall be defined during the detailed design.
- 7.20 CONTRACTOR shall supply these quantities of patch cords listed before or 30% more than the quantities defined in the detailed design, what whichever is greater.
- 7.21 Data Connection Box (Final quantity shall be defined during the detailed design).
- 7.22 Enclosure to house, at least, followed items for distribution of the LAN network:
- a. Internal Optical Distributor - DIO with termination for 06 (six) optic fibers MM – Multimode or according to design;
  - b. Optical-Electrical Converter installed in the box for hazardous areas: 01 (one) for LAN point for each junction box according to Structured cabling one line diagram, WLAN one line diagram and CCTV one line diagram as per the number of equipment to be powered.
  - c. 03 (three) RJ-45 female connector to external area for each Diving Station and Pull-in winch.
  - d. 03 (three) optical-ethernet converter for each Diving Station and Pull-in winch.
  - e. Power supply AC/DC;
  - f. 03 (three) STP patch cord for hazardous areas with 10 meters length and RJ-45 male connector as standalone delivery.
- 7.23 Rack 44U standard 19”**
- 7.23.1. 44U standard 19” Rack for internal installation on topside Modules:
- a. 01 (one) rack for M-13
  - b. 01 (one) rack for M-15B and
  - c. 02 (two) racks for M-17.
- 7.23.1.1. These racks shall be equipped with:
- a. Optical cable with Multimode optical fibers
  - b. DIO - Optical Internal Distributor standard 19”
  - c. Patch Panel standard 19” for 24 (twenty four) ports
  - d. Cables organizers (Final quantity shall be defined during the detailed design).
  - e. 02 (two) power strips with minimum 06 (six) outlets power 220 VAC each one.

|   |                                |  |               |
|---|--------------------------------|--|---------------|
|  | <b>TECHNICAL SPECIFICATION</b> | <b>Nº: I-ET-3010.00-5517-768-PPT-004</b>   | <b>REV. B</b> |
|   | AREA: -                        | SHEET: 18 of 23                            |               |
|   | TITLE:                         | <b>TOPSIDES STRUCTURED CABLING NETWORK</b> | INTERNAL      |

f. Final quantity shall be defined during the detailed design.

g. Electrical switchboards.

## 8. DIMENSIONING CRITERIA

- 8.1 Detailed design shall be render feasible through strategic installation of components, so as to minimize the number of connections and thus optimize costs of materials and/or work to be done.
- 8.2 Detailed design of Structured Cabling network shall be effect in such a manner as to permit the maximum number of facilities (equipment, cables and accessories) to be installed during construction of PETROBRAS FPSO Unit at the shipyard.
- 8.3 The cable launch shall meet the following criteria:
- Horizontal runs, at intervals of less than 02 (two) meters;
  - Vertical runs, at intervals of less than 01 (one) meter;
  - Curves, at the ends only (beginnings and end) for the cables.
- 8.4 Equipment, cables, boxes, materials and accessories for installation in the industrial areas (outdoor or indoor) of unit shall be specified and assembled taking into account the adverse operating conditions on UNIT such as:
- Atmosphere with high content of humidity, salts hydrocarbons and other corrosive factors;
  - Environment subject to the presence of explosive gases shall be in accordance with Hazardous area classification;
  - Exposure to weather conditions and maritime atmosphere;
  - Air temperature: From -10°C up to +50°C;
  - Air Humidity: 95%
- 8.5 A free space of, at least 01 (one) meter wide shall be left between the front of the connections boxes and any other structure or piece of equipment, in order to facilitate servicing.
- 8.6 When designing a junction box, its size and shape should be chosen taking into account the devices it will house and what else may be added in future, in order to enable easy servicing even after future expansion.
- 8.7 Junctions boxes shall not be installed in areas where they would be exposed to the weather. If, in fact, that installation is necessary, junctions boxes suitable for the purpose and built with necessary Ingress Protection degree shall be used.
- 8.8 In junction boxes will be not accept cable glands facing to the up side. It shall be installed facing the down side or lateral sides of the junction boxes. It also are not

|   |   |  |               |
|---|---|--|---------------|
|  | <b>TECHNICAL SPECIFICATION</b>                              | <b>Nº: I-ET-3010.00-5517-768-PPT-004</b> | <b>REV. B</b> |
|   | <b>AREA:</b> -  | <b>SHEET:</b> 19 of 23                   |               |
|   | <b>TITLE:</b><br><b>TOPSIDES STRUCTURED CABLING NETWORK</b> | <b>INTERNAL</b><br><b>OI/CS</b>          |               |

acceptable any opening facing the upward of the box, even if it is closed by cover plug.

- 8.9 When drilling holes in junctions boxes for incoming and outgoing cables by means of cable glands, care shall be taken to refrain from drilling more holes than it is necessary and, if in fact this may occur, the extra holes shall be closed with plugs.
- 8.10 All grounding bus bars shall be of tin-plated copper and painted with green strips.
- 8.11 Connections to the grounding network for equipment and boxes shall be made by means of bolted terminals.
- 8.12 The Structured Cabling and Optical Data Networks shall be made in star physical topology for each Modules listed:
- a. The M-13 Module shall be centralized all structured cabling network from Electrical Panels Room of this module;
  - b. The M-15B Module shall be centralized all structured cabling network from laboratory and operators room.
  - c. The M-17 Module shall be centralized all structured cabling network from all topside modules;
- 8.13 The Structured Network (LAN) shall be distributed as follow:
- a. 03 (three) points for each workstation;
  - b. 01 (one) point for each printer;
  - c. 03 (three) points for each diving area;
  - d. 03 (three) points for Pull-in cabinet winch;
  - e. 01 (one) point for each access point, which location details are in document TOPSIDES WLAN SYSTEM ONE LINE DIAGRAM;
  - f. 01 (one) point for camera which location details are in document TOPSIDES CCTV SYSTEM ONE LINE DIAGRAM;
  - g. 02 (two) points in each MODA system rack;
  - h. 04 (four) points in Interface RRMS system rack;
  - i. 02 (two) points in Telecom Electrical Panel PN-5264001 in M-17;
  - j. 04 (four) points for Electrical System Automation (ESA) DMZ servers rack.
- 8.14 Interconnection cables from data rack patch panels inside PDD of M-17 to MODA and to RRMS equipment rack shall be terminated on RJ-45 outlet tagged accordingly to its subsystem. All other LAN points terminated on RJ-45 outlet shall be TAGGED with TMD.

|   |   |  |               |
|---|---|--|---------------|
|  | <b>TECHNICAL SPECIFICATION</b>                              | <b>Nº: I-ET-3010.00-5517-768-PPT-004</b> | <b>REV. B</b> |
|   | <b>AREA:</b> -  | <b>SHEET:</b> 20 of 23                   |               |
|   | <b>TITLE:</b><br><b>TOPSIDES STRUCTURED CABLING NETWORK</b> | <b>INTERNAL</b><br><b>OI/CS</b>          |               |

- 8.15 CONTRACTOR shall interconnect each of one Structured Cabling rack to Structured Optical Network Interface Box.
- 8.16 There will be 02 (two) interface junction boxes, installed and supplied by Hull, to be used to interconnect data equipment and racks on Main deck, forecandle, modules and diving stations and pull-in cabinet of Topside.
- 8.16.1. CONTRACTOR shall interconnect the racks located in M-13 and M-15B to each Interface Junction Box through by a Fiber Optic cable with 06 (six) fibers, terminated on DIOs on both sides.
- 8.16.2. CONTRACTOR shall interconnect the racks located in M-17 to each Interface Junction Box through by a Fiber Optic cable with 40 (forty) fibers, already included 30% for expansion, terminated on DIOs on both sides.
- 8.16.3. Each electrical or optical access data switch inside PDDs shall be stacked, which pile shall be limited to up to 05 (five) switches, so that the 25Gbps uplink port of the first and the last switch of the pile, to be cabled to each core switch, at WAN racks, inside each Telecom Room, through each interface box. For AEPR module, it shall be foreseen a maximum of 20 (twenty) possible electrical or optical access data switches.
- 8.16.4. Apart from electrical or optical access data switch, the other ones, like electrical or optical switch acts as DMZ ones, special monitoring ones, 3<sup>rd</sup> parties ones, recreative one and IPTV distribution switch one cannot be stacked and shall be directly cabled to each CORE switch, to each DMZ switch and to each 3<sup>rd</sup> party switch in each Telecom Room.
- 8.16.5. CONTRACTOR shall interconnect each junction box located in Topsides Diving Areas and Pull-in Cabinet winch to M-17 DIO through a Fiber Optic cable with 06 (six) fibers, terminated on DIOs on both sides.

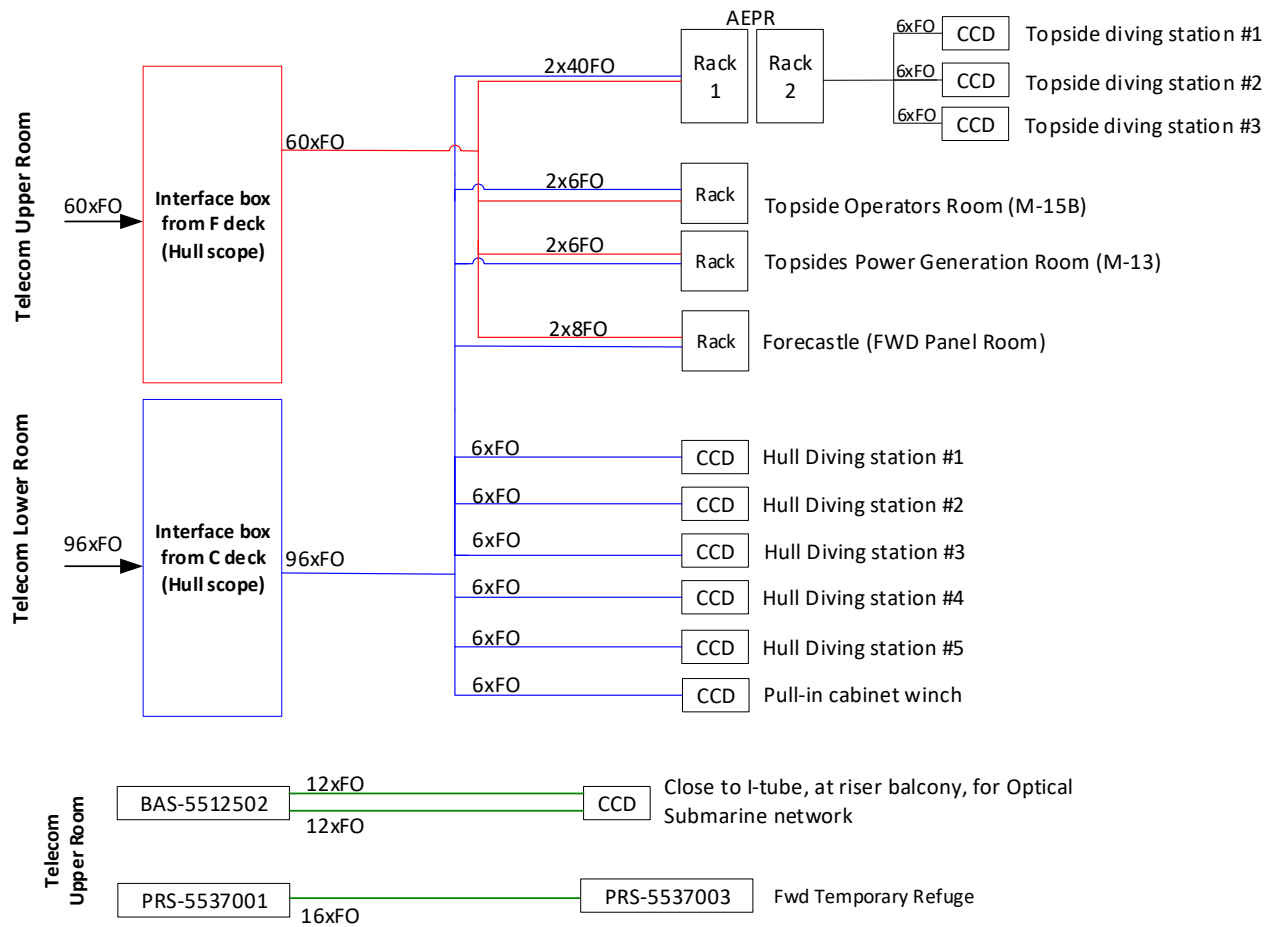



Figure 8: Topology of Topside's network connections through interface boxes

- 8.17 CONTRACTOR shall interconnect MODA panel and RRMS panel to data rack in M-17 through 02 (two) FTP cables to each panel (MODA) and 04 (four) FTP cables to Interface RRMS panel, terminated on patch panels on both sides.
- 8.18 The Telephone points located in the Process Plant and in the Industrial Areas shall be assisted through an Industrial Telephony network that it is not part of this Technical Specification.
- 8.19 Each diving area shall have, at least, 03 (three) LAN points attended by Optical Cable with Optical Distributor (DIO) and Optical-Electrical Converter installed inside the box appropriated for hazardous areas.
- 8.20 The final quantity of points will be defined during the detailed design and shall be approved by the PETROBRAS.
- 8.21 All fiber optics shall be connected and terminated at both ends. For CCT and CCD junction boxes of CCTV and WLAN Systems, it shall be considered at least 04 (four) operational extra fibers in the cable to be connectorized and to be used for future purposes.

|   |                                |  |               |
|---|--------------------------------|--|---------------|
|  | <b>TECHNICAL SPECIFICATION</b> | <b>Nº: I-ET-3010.00-5517-768-PPT-004</b>   | <b>REV. B</b> |
|   | AREA: -                        | SHEET: 22 of 23                            |               |
|   | TITLE:                         | <b>TOPSIDES STRUCTURED CABLING NETWORK</b> |               |
|   |                                | INTERNAL                                   |               |
|   |                                | OI/CS                                      |               |

8.22 CONTRACTOR shall interconnect the rack PN-5140002 with both Electrical System Automation (ESA) DMZ servers, as per I-DE-3010.00-5140-797-P4X-001 ELECTRICAL SYSTEM AUTOMATION ARCHITECURE DIAGRAM, in M-17, to PDD-5517001 by a fiber optic cable with 04 (four) fibers, terminated on DIOs on both sides. One ESA DMZ server shall be connected to DMZ switch in PDD-5517002 and the other shall be connected to DMZ switch in Telecom Lower Room for redundancy.

## 9. COMMISSIONING

- 9.1 The Tests and Certification of the STRUCTURED CABLING AND OPTICAL DATA NETWORK (LAN) shall comply with the DESCRIPTIVE MEMORANDUM I-MD-3010.00-5510-760-PPT-001 – GENERAL CRITERIA FOR TELECOMMUNICATIONS DESIGN and it is summarized below.
- 9.2 The horizontal network of Metallic Cables (FTP) shall be certified according to Standard ANSI/EIA/TIA requirements 568-B2-1 CAT 6 /Class E.
- 9.3 Preferentially shall be used the Fluke Analyzer model DTX-5000 or similar and newer model as instrument of certification of Fluke DTX Cable. In case of other instrument used, it shall present message in case of noise in the cabling.
- 9.4 CONTRACTOR shall supply microscope of 400x for inspection of the connectors in field. Connectors will not be accepted with flaws in the polishing. The tests will be made by sampling.
- 9.5 The network of optical cables shall be certified according to Standard ANSI/EIA/TIA'S requirements 568-B2-1 CAT 6/Class E for optical backbones.
- 9.6 Preferentially, the instrument of certification of Fluke DTX Cable shall be used Analyzer model 5000 or an OTDR.
- 9.7 CONTRACTOR shall submit to PETROBRAS the certification tests CAT 6 for all the installed points and all optical fiber cables, in magnetic media, compatible with the Software of Fluke Link Ware.
- 9.8 All the instruments to be used shall be accompanied by the Certificate of Calibration that shall be inside its period of validity. The Certificate shall be submitted to PETROBRAS before the beginning of the tests and an authenticated copy of the original shall proceed enclosed the Documentation to be given at the end of the work.
- 9.9 All FTP and optical cables shall present certification successful to category 6, including the sockets and connectors.

## 10. ANNEX

- 10.1 On the next table, it is presented an estimative of the number of switches required according to this technical specification requirements.



AREA: -

SHEET: 23 of 23

TITLE: TOPSIDES STRUCTURED CABLING NETWORK

INTERNAL

OI/CS

| ACCESS LAYER |                            |                |                    |  |   |                      |                      |                                       |                                  |  |
|--------------|----------------------------|----------------|--------------------|--|---|----------------------|----------------------|---------------------------------------|----------------------------------|--|
| Module       | PDD                        | Deck/Elevation | Local              | General Use<br>(Data/Voice)              | Servers /<br>Equipment<br>(interconnection) | WLAN<br>(Electrical) | CCTV<br>(Electrical) | Optical Ports<br>(DS, cameras,<br>AP) | IPTV                             | Recreative<br>Internet                 |
| M-17         | PDD-5517001<br>PDD-5517002 | M-17           | M-17               | 6  | 15  | 21                   | 51                   | 162                                   |                                  |  |
|              |                            |                | Área Externa       |  |   |                      |                      |                                       |                                  |  |
|              |                            |                | Subtotal (per use) | 6  | 15  | 21                   | 51                   | 162                                   | 0                                | 0                                      |
|              |                            |                | Switch Type        | Electrical Access Switches - (48P) - 30% |   |                      |                      | Optical Access Switches (24P - 30%)   | IPTV Access Switches (48P) - 30% | Recreative Access Switches (48P) - 30% |
|              |                            |                | Quantity           | 3  |   |                      |                      | 9                                     | 0                                | 0                                      |
| M-13         | PDD-5517003                | M-13           | M-13               | 9  |   |                      | 14                   |                                       |                                  |  |
|              |                            |                | Subtotal (per use) | 9  | 0   | 0                    | 14                   | 0                                     | 0                                | 0                                      |
|              |                            |                | Switch Type        | Electrical Access Switches - (48P) - 30% |   |                      |                      |                                       |                                  |  |
|              |                            |                | Quantity           | 1  |   |                      |                      | 0                                     | 0                                | 0                                      |
| M-15B        | PDD-5517004                | M-15           | Operator's Room    | 13                                       |   |                      | 1                    |                                       |                                  |  |
|              |                            |                | TLT Room           | 4  |   |                      |                      |                                       |                                  |  |
|              |                            |                | Laboratory Office  | 7  |   |                      |                      |                                       |                                  |  |
|              |                            |                | Laboratory Area    | 6  |   |                      | 1                    |                                       |                                  |  |
|              |                            |                | Área Externa       |  |   |                      |                      |                                       |                                  |  |
|              |                            |                | Subtotal (per use) | 30                                       | 0   | 0                    | 2                    | 0                                     | 0                                | 0                                      |
|              |                            |                | Switch Type        | Electrical Access Switches - (48P) - 30% |   |                      |                      | Optical Access Switches (24P - 30%)   | IPTV Access Switches (48P) - 30% | Recreative Access Switches (48P) - 30% |
|              |                            |                | Quantity           | 1  |   |                      |                      | 0                                     | 0                                | 0                                      |

Table 1: estimative of the number of switches